

## 阅读申明

- 1.本站收集的数据手册和产品资料都来自互联网，版权归原作者所有。如读者和版权方有任何异议请及时告之，我们将妥善解决。
- 2.本站提供的中文数据手册是英文数据手册的中文翻译，其目的是协助用户阅读，该译文无法自动跟随原稿更新，同时也可能存在翻译上的不当。建议读者以英文原稿为参考以便获得更精准的信息。
- 3.本站提供的产品资料，来自厂商的技术支持或者使用者的心得体会等，其内容可能存在描述上的差异，建议读者做出适当判断。
- 4.如需与我们联系，请发邮件到marketing@iczoom.com，主题请标有“数据手册”字样。

## Read Statement

1. The datasheets and other product information on the site are all from network reference or other public materials, and the copyright belongs to the original author and original published source. If readers and copyright owners have any objections, please contact us and we will deal with it in a timely manner.
2. The Chinese datasheets provided on the website is a Chinese translation of the English datasheets. Its purpose is for reader's learning exchange only and do not involve commercial purposes. The translation cannot be automatically updated with the original manuscript, and there may also be improper translations. Readers are advised to use the English manuscript as a reference for more accurate information.
3. All product information provided on the website refer to solutions from manufacturers' technical support or users the contents may have differences in description, and readers are advised to take the original article as the standard.
4. If you have any questions, please contact us at marketing@iczoom.com and mark the subject with "Datasheets" .

# HFP2N65U

## 650V N-Channel MOSFET

### FEATURES

- Originative New Design
- Superior Avalanche Rugged Technology
- Robust Gate Oxide Technology
- Very Low Intrinsic Capacitances
- Excellent Switching Characteristics
- Unrivalled Gate Charge : 5.5 nC (Typ.)
- Extended Safe Operating Area
- Lower  $R_{DS(ON)}$  : 5  $\Omega$  (Typ.) @  $V_{GS}=10V$
- 100% Avalanche Tested

$$BV_{DSS} = 650 V$$

$$R_{DS(on) typ} = 5 \Omega$$

$$I_D = 2 A$$

TO-220



1.Gate 2. Drain 3. Source

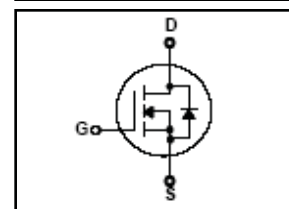

### Absolute Maximum Ratings $T_C=25^\circ C$ unless otherwise specified

Symbol	Parameter	Value	Units
$V_{DSS}$	Drain-Source Voltage	650	V
$I_D$	Drain Current – Continuous ( $T_C = 25^\circ C$ )	2.0	A
	Drain Current – Continuous ( $T_C = 100^\circ C$ )	1.3	A
$I_{DM}$	Drain Current – Pulsed (Note 1)	8.0	A
$V_{GS}$	Gate-Source Voltage	$\pm 30$	V
$E_{AS}$	Single Pulsed Avalanche Energy (Note 2)	116	mJ
$I_{AR}$	Avalanche Current (Note 1)	2.0	A
$E_{AR}$	Repetitive Avalanche Energy (Note 1)	5.4	mJ
dv/dt	Peak Diode Recovery dv/dt (Note 3)	4.5	V/ns
$P_D$	Power Dissipation ( $T_C = 25^\circ C$ ) - Derate above $25^\circ C$	54	W
		0.43	W/ $^\circ C$
$T_J, T_{STG}$	Operating and Storage Temperature Range	-55 to +150	$^\circ C$
$T_L$	Maximum lead temperature for soldering purposes, 1/8" from case for 5 seconds	300	$^\circ C$

### Thermal Resistance Characteristics

Symbol	Parameter	Typ.	Max.	Units
$R_{\theta JC}$	Junction-to-Case	--	2.32	$^\circ C/W$
$R_{\theta CS}$	Case-to-Sink	0.5	--	
$R_{\theta JA}$	Junction-to-Ambient	--	62.5	

## Package Marking and Oding Information

Device Marking	Week Marking	Package	Packing	Quantity	RoHS Status
HFP2N65U	YWWX	TO-220	Tube	50	Pb Free
HFP2N65U	YWWXg	TO-220	Tube	50	Halogen Free

## Electrical Characteristics $T_C=25^\circ\text{C}$ unless otherwise specified

Symbol	Parameter	Test Conditions	Min	Typ	Max	Units
--------	-----------	-----------------	-----	-----	-----	-------

### On Characteristics

$V_{GS}$	Gate Threshold Voltage	$V_{DS} = V_{GS}, I_D = 250 \mu\text{A}$	2.5	--	4.5	V
$R_{DS(ON)}$	Static Drain-Source On-Resistance	$V_{GS} = 10 \text{ V}, I_D = 1.0 \text{ A}$	--	5.0	6.5	$\Omega$

### Off Characteristics

$BV_{DSS}$	Drain-Source Breakdown Voltage	$V_{GS} = 0 \text{ V}, I_D = 250 \mu\text{A}$	650	--	--	V
$\Delta BV_{DSS} / \Delta T_J$	Breakdown Voltage Temperature Coefficient	$I_D = 250 \mu\text{A}$ , Referenced to $25^\circ\text{C}$	--	0.6	--	$\text{V}/^\circ\text{C}$
$I_{DSS}$	Zero Gate Voltage Drain Current	$V_{DS} = 650 \text{ V}, V_{GS} = 0 \text{ V}$	--	--	1	$\mu\text{A}$
		$V_{DS} = 520 \text{ V}, T_C = 125^\circ\text{C}$	--	--	10	$\mu\text{A}$
$I_{GSS}$	Gate-Body Leakage Current	$V_{GS} = \pm 30 \text{ V}, V_{DS} = 0 \text{ V}$	--	--	$\pm 100$	nA

### Dynamic Characteristics

$C_{iss}$	Input Capacitance	$V_{DS} = 25 \text{ V}, V_{GS} = 0 \text{ V},$ $f = 1.0 \text{ MHz}$	--	320	420	pF
$C_{oss}$	Output Capacitance		--	38	50	pF
$C_{rss}$	Reverse Transfer Capacitance		--	6.5	8.5	pF

### Switching Characteristics

$t_{d(on)}$	Turn-On Time	$V_{DS} = 325 \text{ V}, I_D = 2.0 \text{ A},$ $R_G = 25 \Omega$	--	20	50	ns
$t_r$	Turn-On Rise Time		--	20	50	ns
$t_{d(off)}$	Turn-Off Delay Time		--	30	70	ns
$t_f$	Turn-Off Fall Time	(Note 4,5)	--	20	50	ns
$Q_g$	Total Gate Charge	$V_{DS} = 520 \text{ V}, I_D = 2.0 \text{ A},$ $V_{GS} = 10 \text{ V}$	--	5.5	7.5	nC
$Q_{gs}$	Gate-Source Charge		--	1.8	--	nC
$Q_{gd}$	Gate-Drain Charge		(Note 4,5)	--	3.5	--

### Source-Drain Diode Maximum Ratings and Characteristics

$I_S$	Continuous Source-Drain Diode Forward Current	--	--	2.0	A	
$I_{SM}$	Pulsed Source-Drain Diode Forward Current	--	--	8.0		
$V_{SD}$	Source-Drain Diode Forward Voltage	$I_S = 2.0 \text{ A}, V_{GS} = 0 \text{ V}$	--	--	1.4	V
$t_{rr}$	Reverse Recovery Time	$I_S = 2.0 \text{ A}, V_{GS} = 0 \text{ V}$ $di_F/dt = 100 \text{ A}/\mu\text{s}$ (Note 4)	--	206	--	ns
$Q_{rr}$	Reverse Recovery Charge		--	0.76	--	$\mu\text{C}$

#### Notes ;

1. Repetitive Rating : Pulse width limited by maximum junction temperature
2.  $L=53\text{mH}, I_{AS}=2\text{A}, V_{DD}=50\text{V}, R_G=25\Omega$ , Starting  $T_J=25^\circ\text{C}$
3.  $I_{SD}\leq 2\text{A}, di/dt\leq 200\text{A}/\mu\text{s}, V_{DD}\leq BV_{DSS}$ , Starting  $T_J=25^\circ\text{C}$
4. Pulse Test : Pulse Width  $\leq 300\mu\text{s}$ , Duty Cycle  $\leq 2\%$
5. Essentially Independent of Operating Temperature

# Typical Characteristics

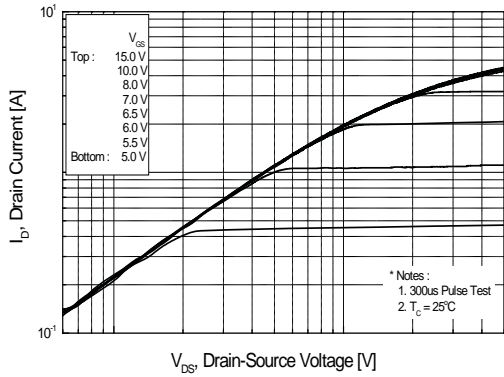

Figure 1. On Region Characteristics

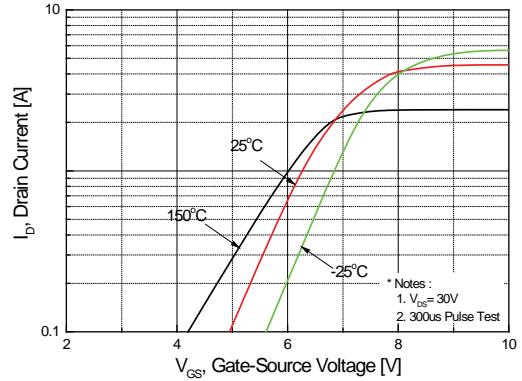

Figure 2. Transfer Characteristics

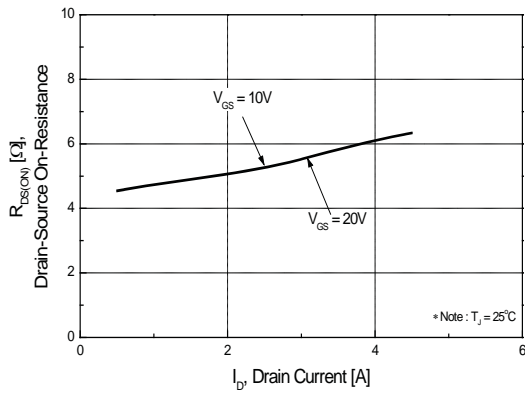

Figure 3. On Resistance Variation vs Drain Current and Gate Voltage

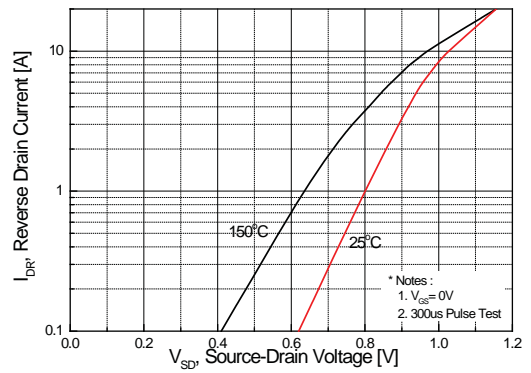

Figure 4. Body Diode Forward Voltage Variation with Source Current and Temperature

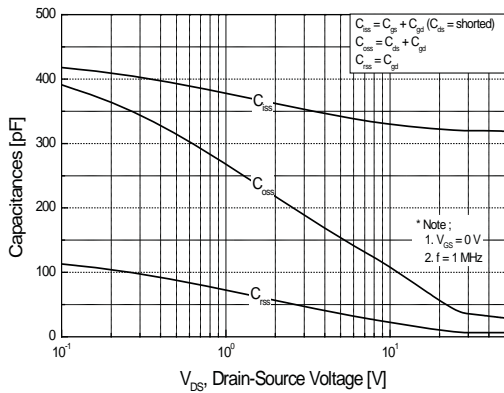

Figure 5. Capacitance Characteristics

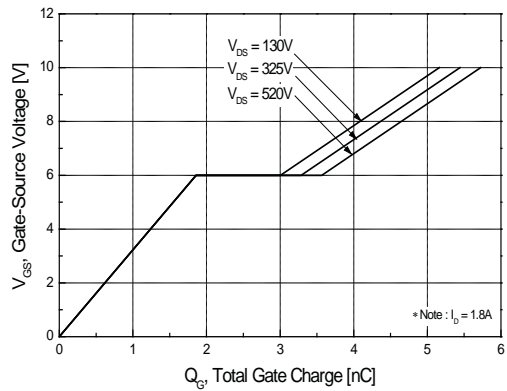

Figure 6. Gate Charge Characteristics

Typical Characteristics (continued)

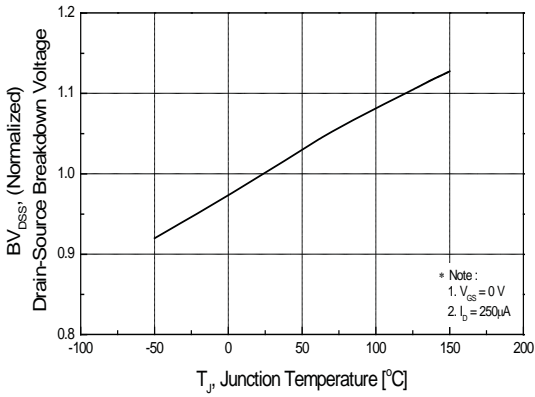

Figure 7. Breakdown Voltage Variation vs Temperature

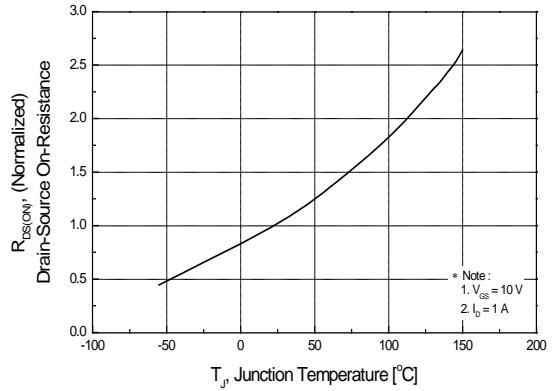

Figure 8. On-Resistance Variation vs Temperature

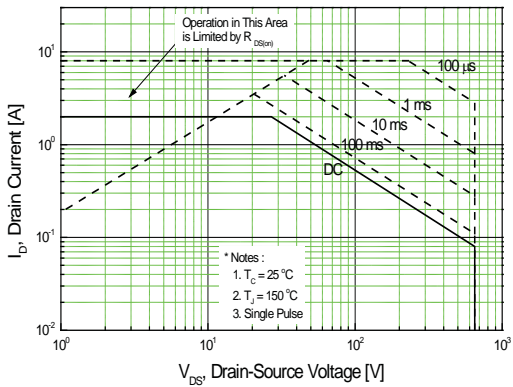

Figure 9. Maximum Safe Operating Area

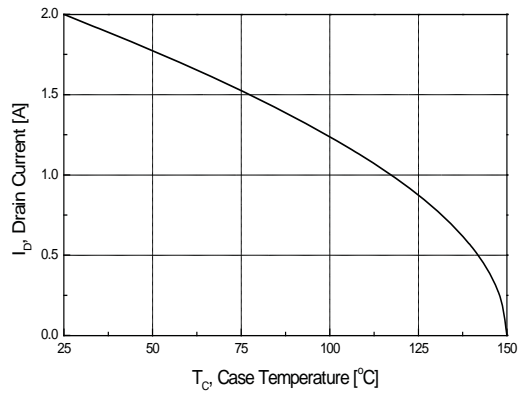

Figure 10. Maximum Drain Current vs Case Temperature

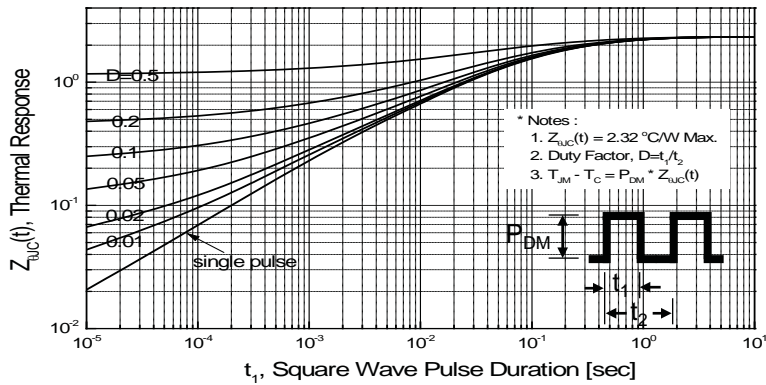

Figure 11. Transient Thermal Response Curve

Fig 12. Gate Charge Test Circuit & Waveform



Fig 13. Resistive Switching Test Circuit & Waveforms

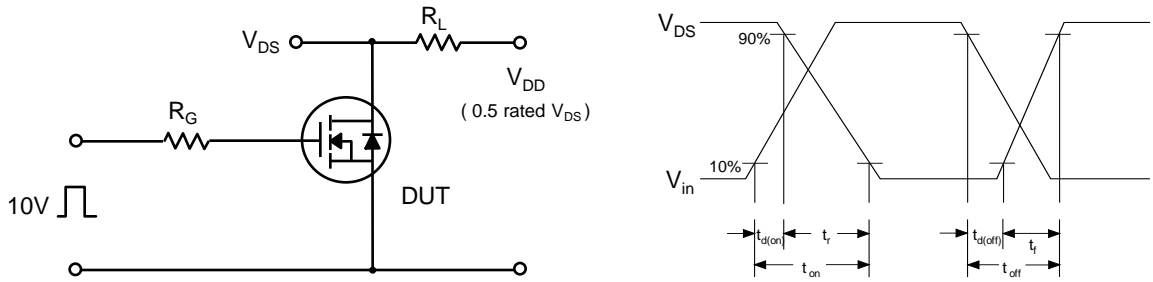

Fig 14. Unclamped Inductive Switching Test Circuit & Waveforms

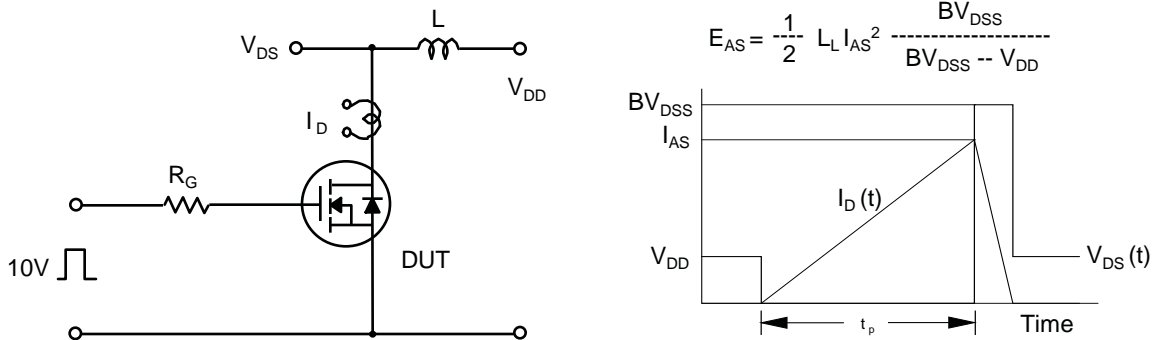
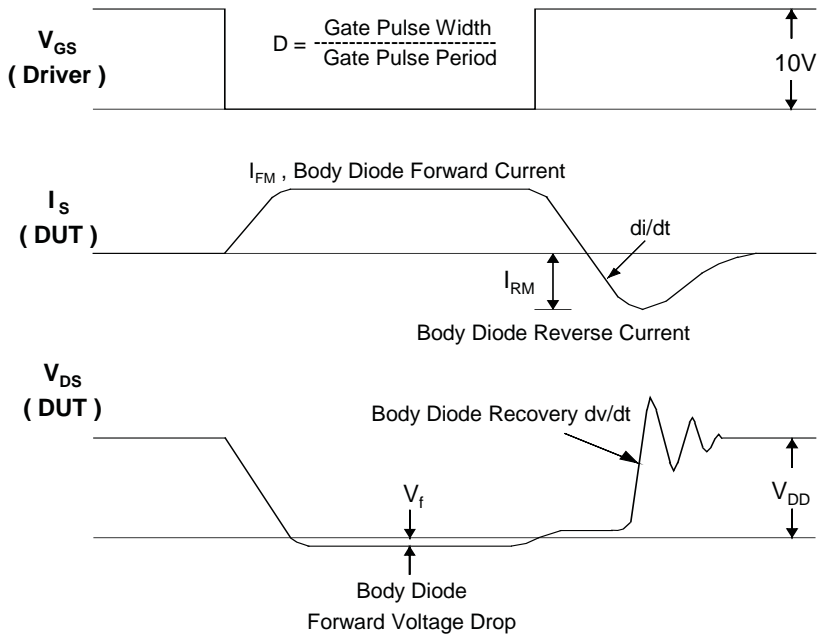
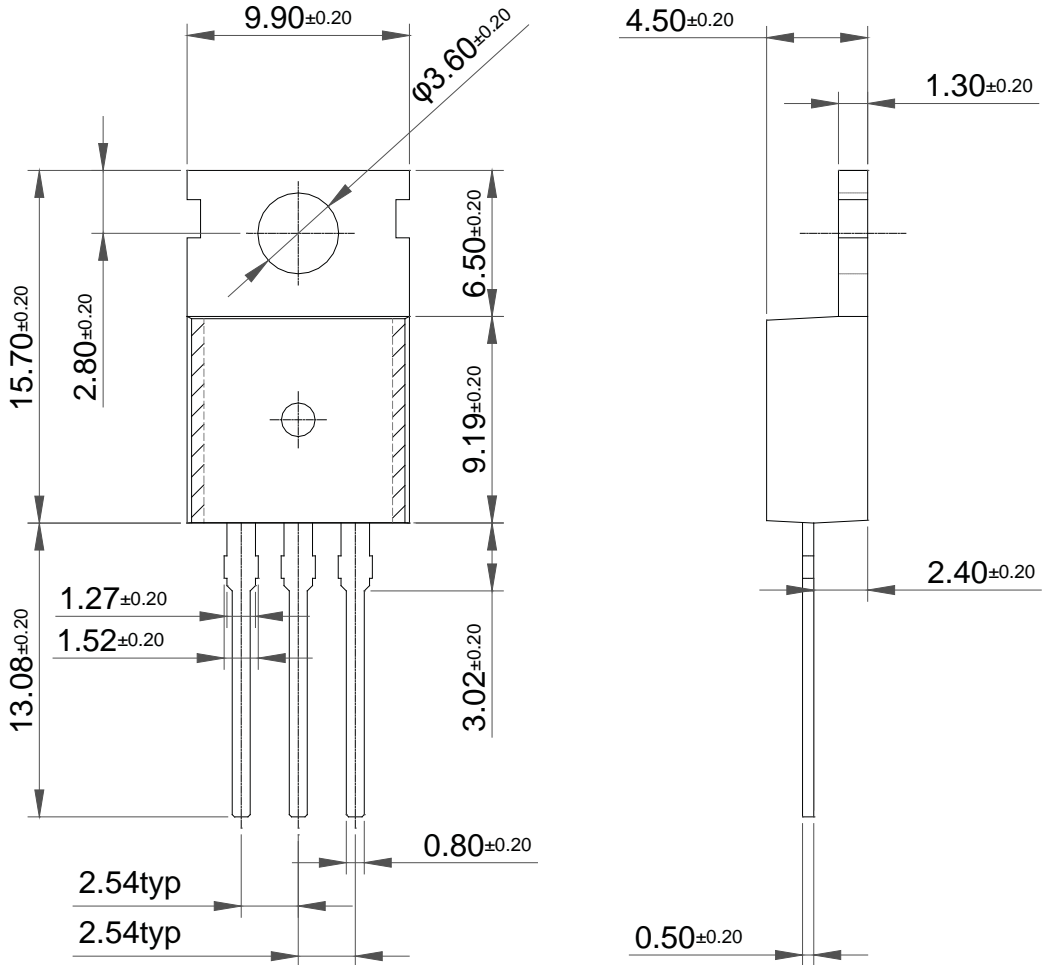

Fig 15. Peak Diode Recovery dv/dt Test Circuit & Waveforms



Package Dimension

TO-220 (A)





Package Dimension

TO-220 (B)

