

## 阅读申明

- 1.本站收集的数据手册和产品资料都来自互联网，版权归原作者所有。如读者和版权方有任何异议请及时告之，我们将妥善解决。
- 2.本站提供的中文数据手册是英文数据手册的中文翻译，其目的是协助用户阅读，该译文无法自动跟随原稿更新，同时也可能存在翻译上的不当。建议读者以英文原稿为参考以便获得更精准的信息。
- 3.本站提供的产品资料，来自厂商的技术支持或者使用者的心得体会等，其内容可能存在描述上的差异，建议读者做出适当判断。
- 4.如需与我们联系，请发邮件到marketing@iczoom.com，主题请标有“数据手册”字样。

## Read Statement

1. The datasheets and other product information on the site are all from network reference or other public materials, and the copyright belongs to the original author and original published source. If readers and copyright owners have any objections, please contact us and we will deal with it in a timely manner.
2. The Chinese datasheets provided on the website is a Chinese translation of the English datasheets. Its purpose is for reader's learning exchange only and do not involve commercial purposes. The translation cannot be automatically updated with the original manuscript, and there may also be improper translations. Readers are advised to use the English manuscript as a reference for more accurate information.
3. All product information provided on the website refer to solutions from manufacturers' technical support or users the contents may have differences in description, and readers are advised to take the original article as the standard.
4. If you have any questions, please contact us at marketing@iczoom.com and mark the subject with "Datasheets" .

## **PWM Control 3A Step-Down Converter**

### ❖ GENERAL DESCRIPTION

AX3112/A consists of step-down switching regulator with PWM control. The device includes a reference voltage source, oscillation circuit, error amplifier, internal PMOS and etc.

AX3112/A provides low-ripple power, high efficiency, and excellent transient characteristics. The PWM control circuit is able to the duty ratio linearly forms 0 up to 100%. With the addition of an internal P-channel Power MOS, a coil, capacitors, and a diode connected externally, these ICs can function as step-down switching regulators. They serve as ideal power supply units for portable devices when coupled with the SOP-8L-EP package, providing such outstanding features as low current consumption. Since this converter can accommodate an input voltage up to 40V, it is also suitable for the operation via an AC adapter.

### ❖ FEATURES

- Input voltage : 8V to 40V
- Adjustable version output voltage range from 3.3V to 38V
- Duty ratio : 0% to 100% PWM control
- Oscillation frequency : 100K/350 KHz
- Enable and auto restart function.
- Thermal Shutdown function / Internal OVP.
- Short Circuit Protect (SCP).
- Built-in internal SW P-channel MOS.
- SOP-8L-EP Pb-Free package.

❖ BLOCK DIAGRAM

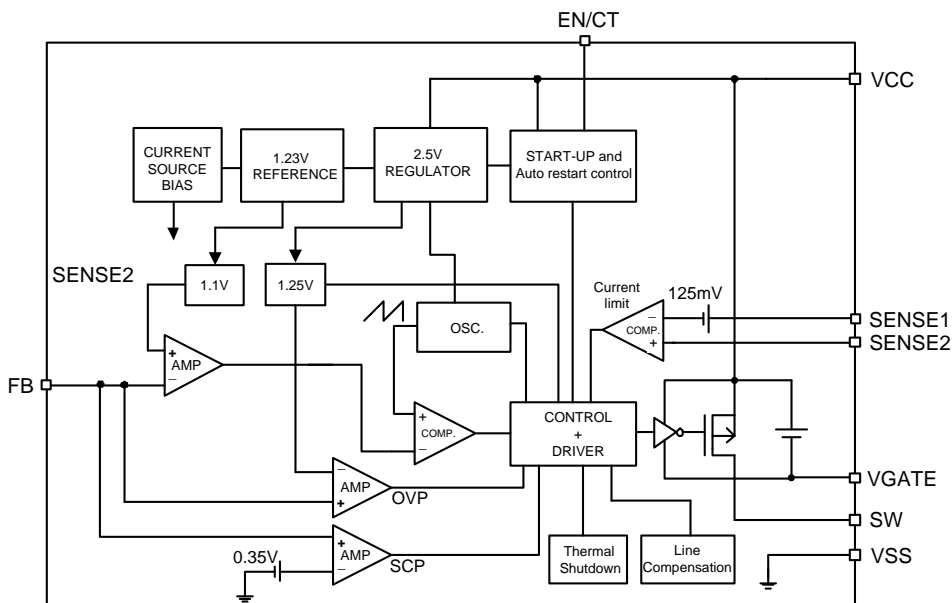

❖ PIN ASSIGNMENT

The package of AX3112/A is SOP-8L-EP; the pin assignment is given by:

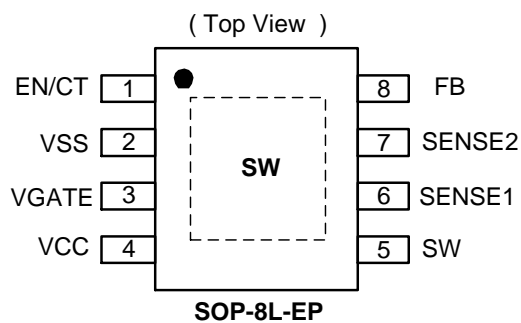

Name	Description
EN/CT	ON/OFF and auto restart control
VSS	GND pin
VGATE	Driver gate clamping pin. The pin must connect a 0.1uF capacitor to VCC
VCC	Operating voltage input
SW	Switch pin. Connect external inductor and diode here
SENSE1	Current sense input1
SENSE2	Current sense input2
FB	Feedback pin

❖ ORDER/MARKING INFORMATION

Order Information	Top Marking
<p><b>AX3112 X XX X</b></p> <p>Frequency Package Type Packing            Blank : 100KHz ES: SOP-8L-EP Blank : Tube            A: 350KHz A : Taping</p> <p>Sense Voltage Accuracy            BIN1: -5%~+12% (Only for 350KHz)            BIN2: ±12%</p>	<p>Logo ← <b>AX3112</b> → Part number            A Y Y W W X → ID code: internal            WW: 01~52            Year: 10=2010                  11=2011                  ⋮                  19=2019</p> <p>Blank: AX3112            A: AX3112A</p>

❖ ABSOLUTE MAXIMUM RATINGS (at T<sub>A</sub> = 25°C)

Characteristics	Symbol	Rating	Unit
VCC Pin Voltage	V <sub>CC</sub>	V <sub>SS</sub> - 0.3 to V <sub>SS</sub> + 45	V
Feedback Pin Voltage	V <sub>FB</sub>	V <sub>SS</sub> - 0.3 to 38	V
EN/CT Pin Voltage		V <sub>SS</sub> - 0.3 to 6	V
SENSE1,SENSE2 Pin Voltage		V <sub>SS</sub> - 0.3 to 38	V
Switch Pin Voltage	V <sub>SW</sub>	V <sub>SS</sub> - 0.3 to V <sub>CC</sub> + 0.3	V
Power Dissipation	PD	(T <sub>J</sub> - T <sub>A</sub> )/ θ <sub>JA</sub>	W
Storage Temperature Range	T <sub>ST</sub>	-65 to +150	°C
Operating Temperature Range	T <sub>OP</sub>	-40 to +85	°C
Operating Supply Voltage	V <sub>OP</sub>	+8 to +40	V
Output Current	I <sub>OUT</sub>	0 to 3	A
Thermal Resistance from Junction to case	θ <sub>JC</sub>	15	°C/W
Thermal Resistance from Junction to ambient	θ <sub>JA</sub>	75	°C/W

Note : θ<sub>JA</sub> is measured with the PCB copper are (need connect to Exposed pad) of approximately 1 in<sup>2</sup>(Multi-layer).

**❖ ELECTRICAL CHARACTERISTICS** ( $V_{CC}=12V$ ,  $T_A=25^{\circ}C$ , unless otherwise specified)

Characteristics	Symbol	Conditions	Min	Typ	Max	Units
FB	$V_{FB}$	$I_{OUT}=10mA$	1.08	1.10	1.12	V
Under Voltage Lockout	$U_{VLO}$	Falling	-	6	-	V
UVLO Hysteresis	-		-	0.8	-	V
OVP detect voltage	$V_{OVP}$	FB floating	-	1.250	-	V
Line Regulation	-	$V_{CC}=10 \sim 40V$	-	0.5	1	%
Load Regulation	-	$I_{OUT}=0 \sim 1A$ , $R_{SENSE} = 140m\Omega$	-	0.3	0.6%	mV
Quiescent Current	$I_{CCQ}$	$V_{FB} > 1.2V$	-	3	6	mA
Oscillator frequency	$F_{OSC}$	AX3112	80	100	120	KHz
		AX3112A	280	350	420	
Max. Duty Cycle (ON)	DC	Force driver on $V_{FB} = 0.7V$	-	100	-	%
Min. Duty Cycle (OFF)		Force driver off $V_{FB} = 1.2V$	-	0	-	
Internal MOSFET $R_{DSON}$	$R_{DSON}$	$V_{CC}=12V$ , $V_{FB} = 0.7V$	-	110	170	m $\Omega$
Sense Voltage (BIN1)	$V_{SENSE}$	$V_{SENSE1}-V_{SENSE2}$	119	125	140	mV
Sense Voltage (BIN2)	$V_{SENSE}$	$V_{SENSE1}-V_{SENSE2}$	110	125	140	mV
Sense Voltage Hysteresis	$V_{SENSE-h}$		-	45	-	mV
EN/CT pin logic input threshold voltage	$V_{EN}$	Shutdown mode	-		0.3	V
	$V_{CT}$	Auto restart, $V_{FB}<0.4V$	0.5		1.5	
EN/CT pin current	$I_{EN/CT-C}$	Charge current	-	-32	-	$\mu A$
EN/CT pin current	$I_{EN/CT-D}$	Discharge current	-	1.5	-	$\mu A$
Thermal shutdown Temp	$T_{SD}$		-	160	-	$^{\circ}C$
Thermal Shutdown Hysteresis	$T_{SH}$		-	40	-	$^{\circ}C$

❖ APPLICATION CIRCUIT

(1) AL CAPACITOR

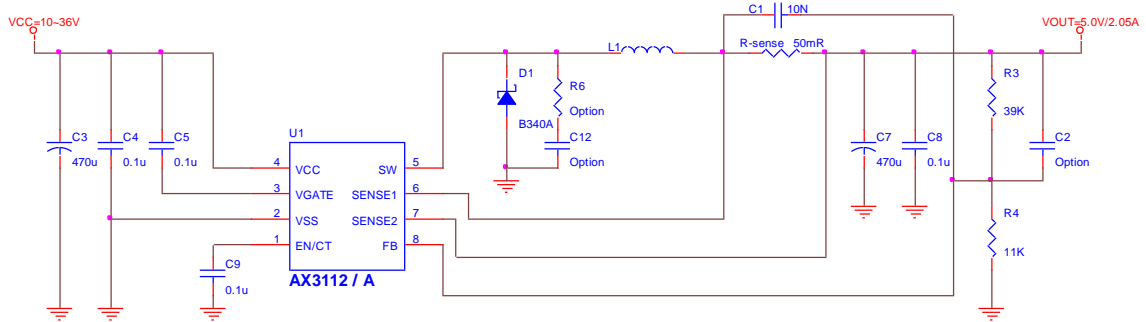

$$V_{OUT} = 1.1V \times \left(1 + \frac{R3}{R4}\right)$$

L1 recommend value (VIN=10~36V, VOUT=5V)		
Version	AX3112	AX3112A
L1 Value (H)	66u	22u

(2) MLCC

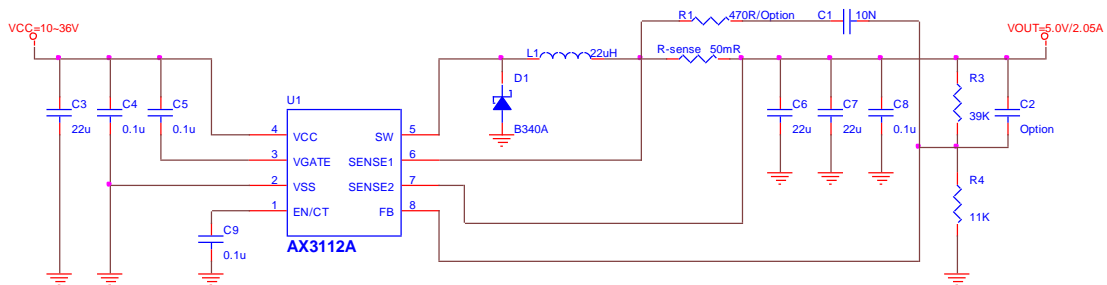

❖ **FUNCTION DESCRIPTIONS**  
**SENSE1/2**

The current limit sense pin, if  $V_{SENSE1}-V_{SENSE2} \geq 125mV$ , the over current is happened that it can turn-off driver cycle by cycle.

**EN/CT**

The pin is enable/shutdown and auto restart control functions. When system is normal operating, this pin is enable/shutdown function. Pulling this pin below a threshold voltage of under 0.3V shuts the regulator off, and pulling this pin from 0.5V to 1.5V turns the regulator on. However when  $V_{OUT}$  is short ( $V_{FB}<0.4V$ ), the auto restart function can be started that restart the regulator cycle by cycle. The cycle time is set by outside capacitor (C6). Please refer the below waveform and formula, the t2 cycle is regulator off time and t1 cycle is current limit time. The charge-current is 32uA and discharge-current is 1.5uA.

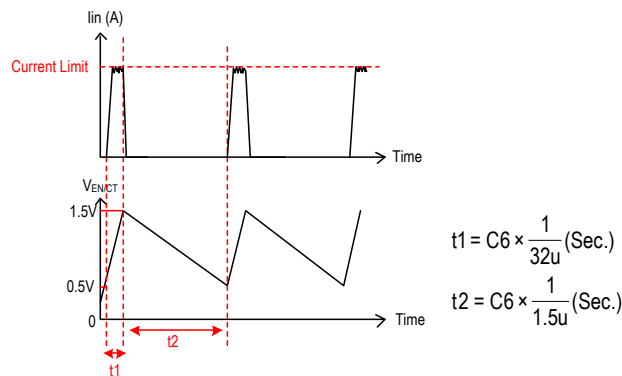

**Under Voltage Lockout (UVLO)**

To avoid error-operation of the device at low input voltages an under voltage lockout is included that disables the device, if the input voltage falls below 6.0V.

**Current Limit Protection**

The Current limit is set by outside resistance ( $R_{SENSE}$ ), When the SENSE1-SENSE2 voltage larger than 125mV, the current limit is happened that driver can be turned off until the drop is small than 80mV. The current limit set according to the following equation:

$$\text{Current Limit (A)} = \frac{125m + (125 - 45)m}{2 \times R_{SENSE}}$$

The maximum output current table is shown as below;  
Please refer the table to design.

RSENSE ( $\Omega$ )	Maximum Output Current (A)
50m	2.05
100m	1.03

**Freq =350KHz**

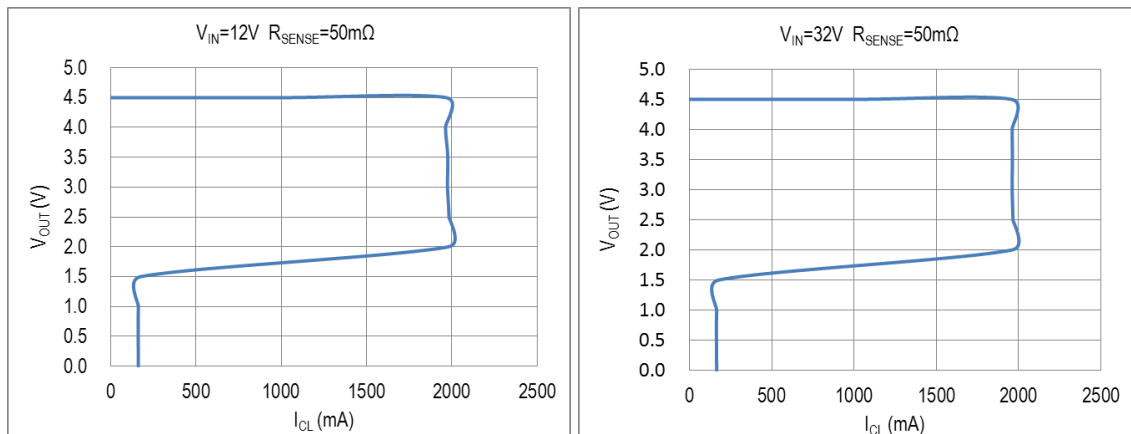

**Freq =100KHz**

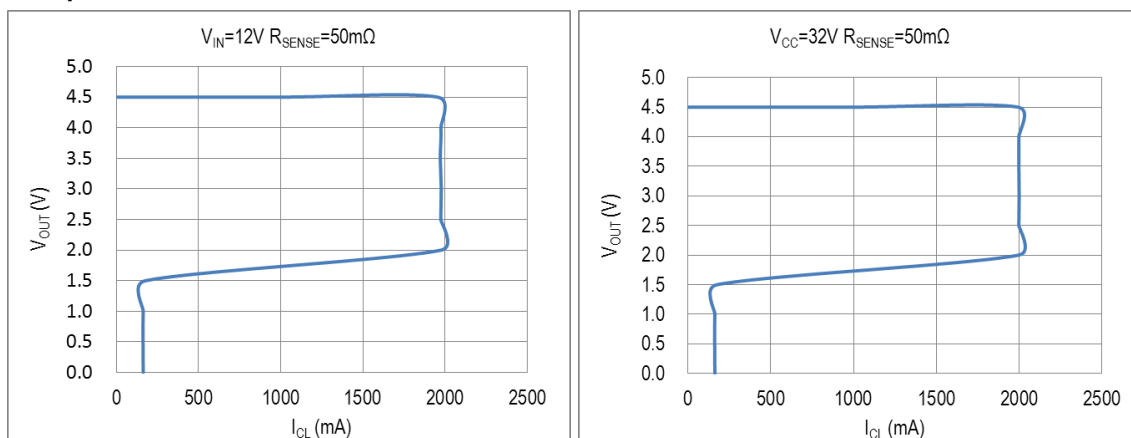

**Thermal Considerations**

The SOP-8L-EP package needs a heat sink under most conditions. The heat sink connect exposed pad of AX3112/A to obtain best effect. The size of the heat sink depends on the input voltage, output voltage, output current and ambient temperature.



❖ TYPICAL CHARACTERISTICS

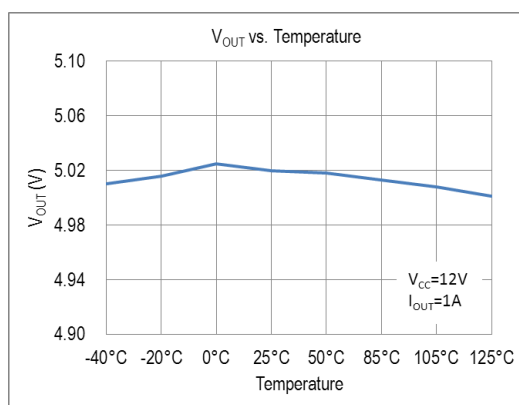
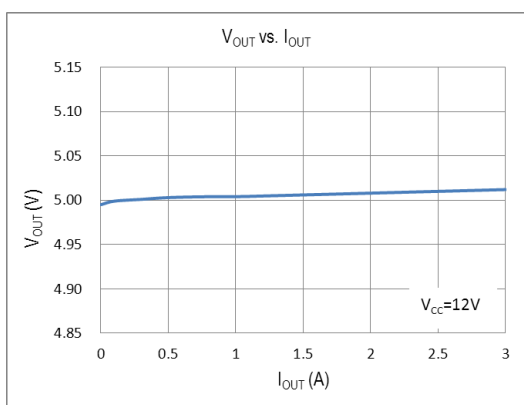
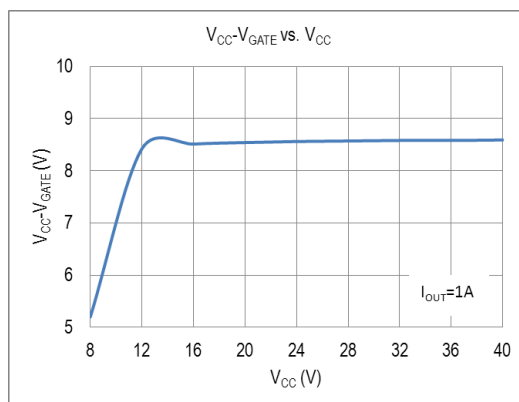
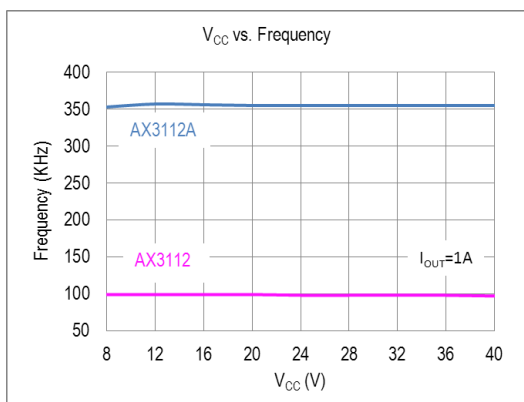
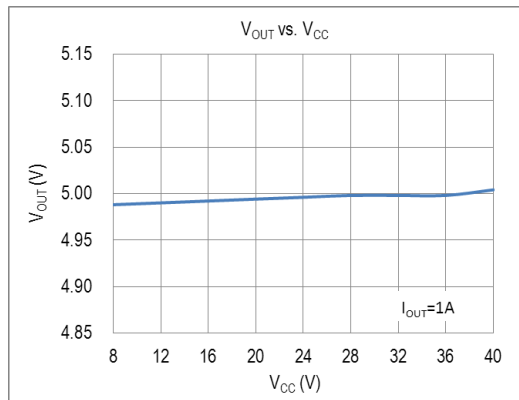
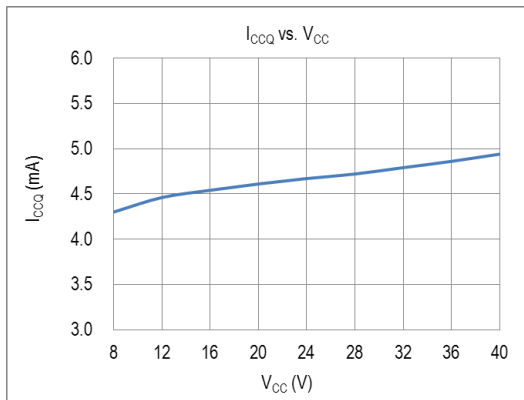

❖ TYPICAL CHARACTERISTICS (CONTINUOUS)

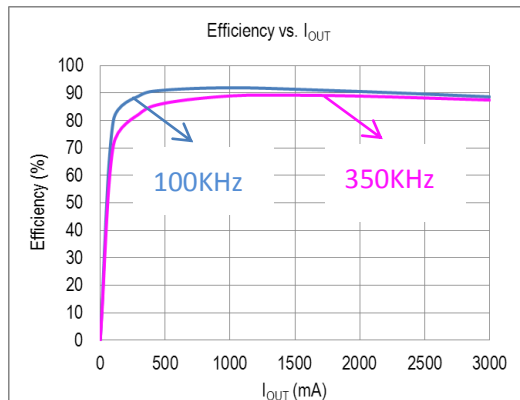
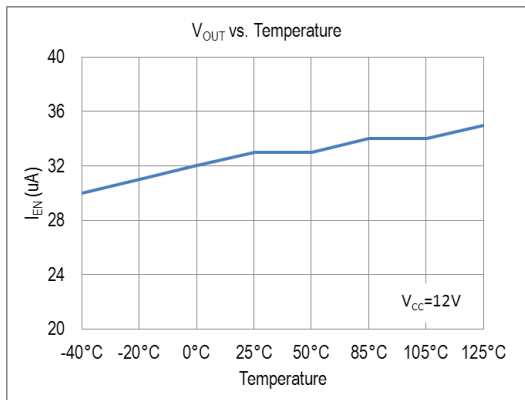

V<sub>CC</sub>=32V, V<sub>OUT</sub>=5V, I<sub>OUT</sub>=2A, C<sub>EN</sub>=0.1u, C<sub>OUT</sub>=470u

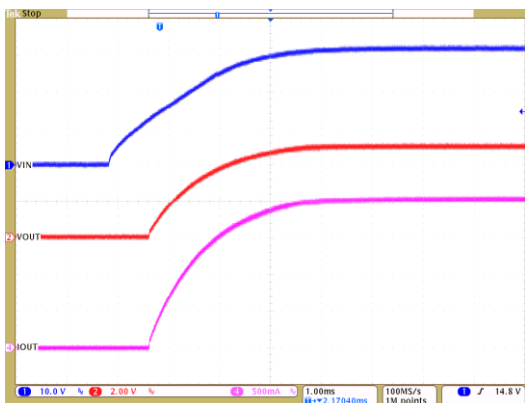

V<sub>CC</sub> =32V, V<sub>OUT</sub>=5V, I<sub>OUT</sub>=1A, C<sub>EN</sub>=0.1u, C<sub>OUT</sub>=22u × 2

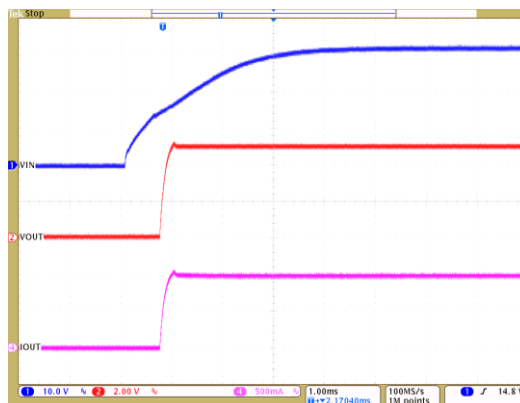

V<sub>CC</sub>=32V, V<sub>OUT</sub>=1.2V, I<sub>OUT</sub>=1.5A  
Thermal Shutdown Release



V<sub>CC</sub>=32V, V<sub>OUT</sub>=5V, I<sub>OUT</sub>=1.5A  
Short Circuit Release

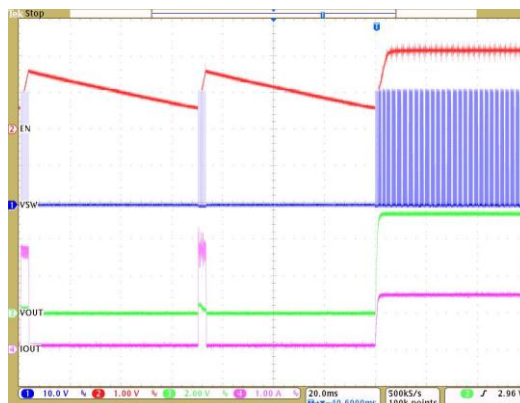

❖ **TYPICAL CHARACTERISTICS (CONTINUOUS)**

$V_{CC}=12V, V_{OUT}=5V, I_{OUT}=0\sim 2A$

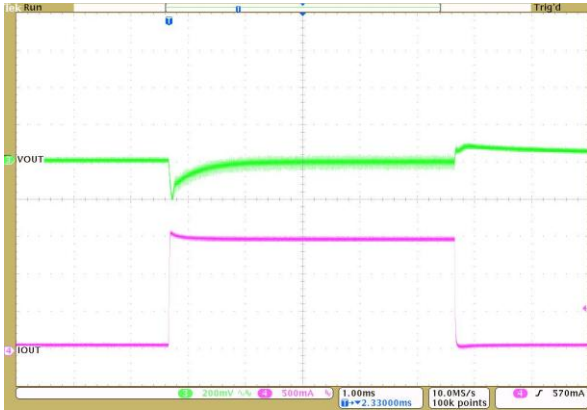

$V_{CC}=32V, V_{OUT}=5V, I_{OUT}=0\sim 2A$

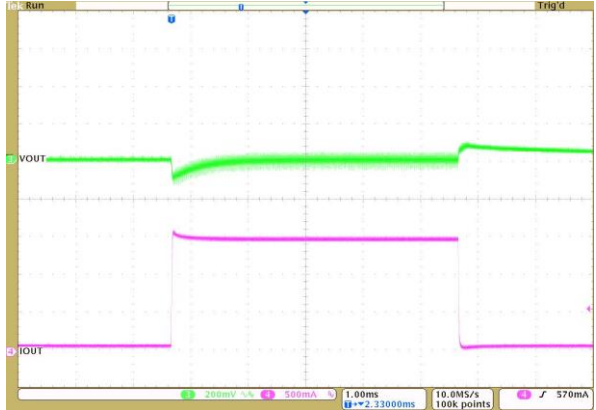

❖ PACKAGE OUTLINES

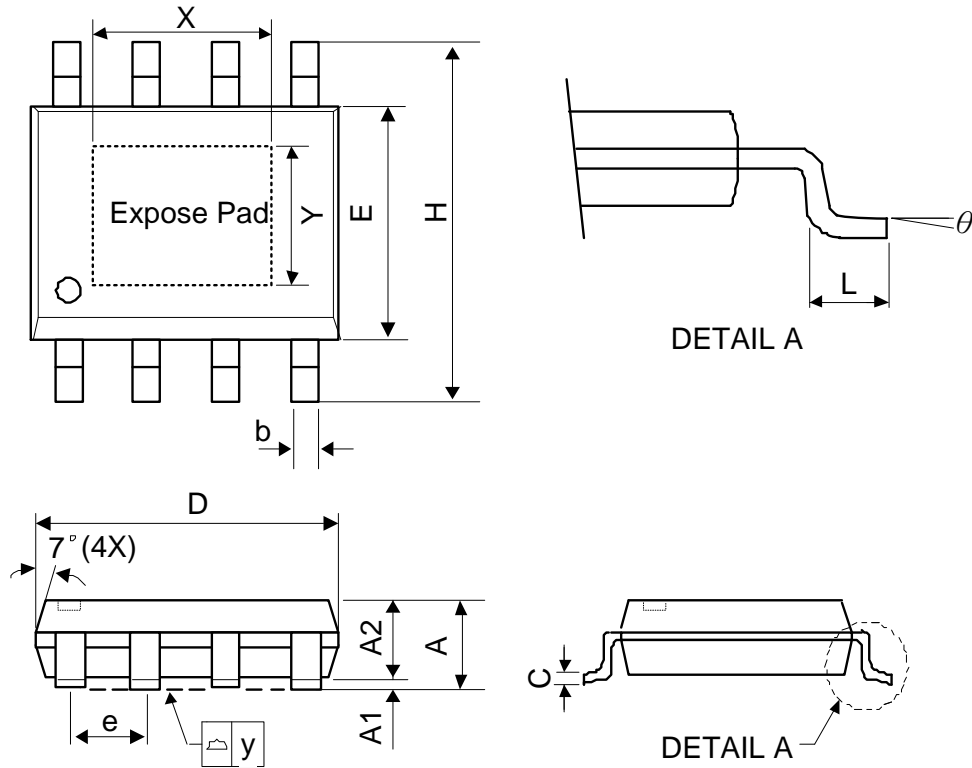

Symbol	Dimensions in Millimeters			Dimensions in Inches		
	Min.	Nom.	Max.	Min.	Nom.	Max.
A	-	-	1.75	-	-	0.069
A1	0	-	0.15	0	-	0.06
A2	1.25	-	-	0.049	-	-
C	0.1	0.2	0.25	0.0075	0.008	0.01
D	4.7	4.9	5.1	0.185	0.193	0.2
E	3.7	3.9	4.1	0.146	0.154	0.161
H	5.8	6	6.2	0.228	0.236	0.244
L	0.4	-	1.27	0.015	-	0.05
b	0.31	0.41	0.51	0.012	0.016	0.02
e	1.27 BSC			0.050 BSC		
y	-	-	0.1	-	-	0.004
X	-	2.34	-	-	0.092	-
Y	-	2.34	-	-	0.092	-
θ	0°	-	8°	0°	-	8°

Mold flash shall not exceed 0.25mm per side  
JEDEC outline: MS-012 BA