

阅读申明

- 1.本站收集的数据手册和产品资料都来自互联网，版权归原作者所有。如读者和版权方有任何异议请及时告之，我们将妥善解决。
- 2.本站提供的中文数据手册是英文数据手册的中文翻译，其目的是协助用户阅读，该译文无法自动跟随原稿更新，同时也可能存在翻译上的不当。建议读者以英文原稿为参考以便获得更精准的信息。
- 3.本站提供的产品资料，来自厂商的技术支持或者使用者的心得体会等，其内容可能存在描述上的差异，建议读者做出适当判断。
- 4.如需与我们联系，请发邮件到marketing@iczoom.com，主题请标有“数据手册”字样。

Read Statement

1. The datasheets and other product information on the site are all from network reference or other public materials, and the copyright belongs to the original author and original published source. If readers and copyright owners have any objections, please contact us and we will deal with it in a timely manner.
2. The Chinese datasheets provided on the website is a Chinese translation of the English datasheets. Its purpose is for reader's learning exchange only and do not involve commercial purposes. The translation cannot be automatically updated with the original manuscript, and there may also be improper translations. Readers are advised to use the English manuscript as a reference for more accurate information.
3. All product information provided on the website refer to solutions from manufacturers' technical support or users the contents may have differences in description, and readers are advised to take the original article as the standard.
4. If you have any questions, please contact us at marketing@iczoom.com and mark the subject with "Datasheets" .

DATA SHEET

GENERAL PURPOSE CHIP RESISTORS

RC_L series

$\pm 0.1\%$, $\pm 0.5\%$, $\pm 1\%$, $\pm 5\%$

Sizes 0075/0100/0201/0402/0603/0805/
1206/1210/1218/2010/2512

RoHS compliant & Halogen free



SCOPE

This specification describes RC series chip resistors with lead free terminations made by thick film process.

APPLICATIONS

- All general purpose application

FEATURES

- Halogen Free Epoxy
- RoHS compliant
 - Products with lead free terminations meet RoHS requirements
 - Pb-glass contained in electrodes, resistors element and glass are exempted by RoHS
- Reducing environmentally hazardous wastes
- High component and equipment reliability
- Saving of PCB space
- None forbidden-materials used in products/production

ORDERING INFORMATION - GLOBAL PART NUMBER

Global part numbers are identified by the series, size, tolerance, packing type, temperature coefficient, taping reel and resistance value.

GLOBAL PART NUMBER

RC XXXX X X X XX XXXX L
 (1) (2) (3) (4) (5) (6) (7)

(1) SIZE

0075/0100/0201/0402/0603/0805/1206/1210/1218/2010/2512

(2) TOLERANCE

B = ±0.1%
 D = ±0.5%
 F = ±1.0%
 J = ±5.0% (for jumper ordering, use code of J)

(3) PACKAGING TYPE

R = Paper taping reel
 K = Embossed taping reel
 S = ESD safe reel (0075/0100 only)

(4) TEMPERATURE COEFFICIENT OF RESISTANCE

- = Based on spec.

(5) TAPING REEL

07= 7 inch dia. Reel
 10=10 inch dia. Reel
 13=13 inch dia. Reel
 7W = 7 inch dia. Reel & 2 x standard power
 7N = 7 inch dia. Reel, ESD safe reel (0075/0100 only)

(6) RESISTANCE VALUE

There are 2~4 digits indicated the resistance value.
 Letter R/K/M is decimal point
 Example:
 97R6 = 97.6Ω
 9K76 = 9760Ω
 1M = 1,000,000Ω

(7) DEFAULT CODE

Letter L is the system default code for ordering only.(Note)

ORDERING EXAMPLE

The ordering code for a RC0402 0.0625W chip resistor value 100KΩ with ±5% tolerance, supplied in 7-inch tape reel of 10,000 units per reel is: RC0402JR-07100KL.

NOTE

1. All our RSMD products meet RoHS compliant and Halogen Free. "LFP" of the internal 2D reel label mentions "Lead Free Process".
2. On customized label, "LFP" or specific symbol can be printed.

MARKING

RC0075 / RC0100 / RC0201 / RC0402



No Marking

RC0603

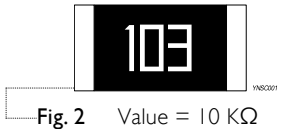

E24 series: 3 digits
First two digits for significant figure and 3rd digit for number of zeros

RC0805 / RC1206 / RC1210 / RC2010 / RC2512

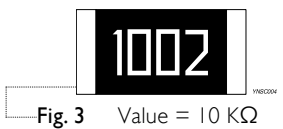

E24/E96 series: 4 digits
First three digits for significant figure and 4th digit for number of zeros

RC1218

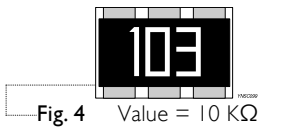

E-24 series: 3 digits, ±5%
First two digits for significant figure and 3rd digit for number of zeros

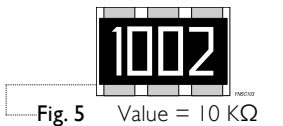

Both E-24 and E-96 series: 4 digits, ±1% & ±0.5%
First three digits for significant figure and 4th digit for number of zeros

For further marking information, please see special data sheet "Chip resistors marking".

CONSTRUCTION

The resistor is constructed on top of a high-grade ceramic body. Internal metal electrodes are added on each end to make the contacts to the thick film resistive element. The composition of the resistive element is a noble metal imbedded into a glass and covered by a second glass to prevent environmental influences. The resistor is laser trimmed to the rated resistance value. The resistor is covered with a protective epoxy coat, finally the two external terminations (matte tin on Ni-barrier) are added, as shown in Fig.6.

Outlines

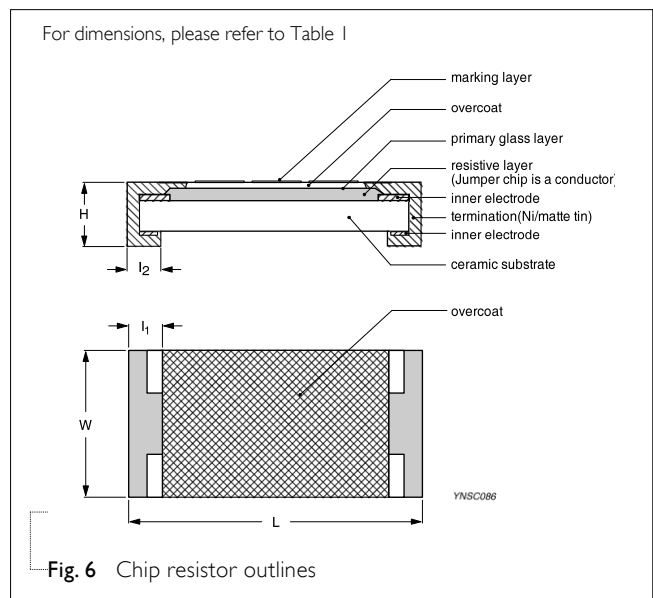

Fig. 6 Chip resistor outlines

DIMENSION

Table 1

| TYPE | L (mm) | W (mm) | H (mm) | l ₁ (mm) | l ₂ (mm) |
|--------|-----------|-----------|-----------|---------------------|---------------------|
| RC0075 | 0.30±0.01 | 0.15±0.01 | 0.10±0.01 | 0.08±0.03 | 0.08±0.03 |
| RC0100 | 0.40±0.02 | 0.20±0.02 | 0.13±0.02 | 0.10±0.03 | 0.10±0.03 |
| RC0201 | 0.60±0.03 | 0.30±0.03 | 0.23±0.03 | 0.10±0.05 | 0.15±0.05 |
| RC0402 | 1.00±0.05 | 0.50±0.05 | 0.35±0.05 | 0.20±0.10 | 0.25±0.10 |
| RC0603 | 1.60±0.10 | 0.80±0.10 | 0.45±0.10 | 0.25±0.15 | 0.25±0.15 |
| RC0805 | 2.00±0.10 | 1.25±0.10 | 0.50±0.10 | 0.35±0.20 | 0.35±0.20 |
| RC1206 | 3.10±0.10 | 1.60±0.10 | 0.55±0.10 | 0.45±0.20 | 0.40±0.20 |
| RC1210 | 3.10±0.10 | 2.60±0.15 | 0.55±0.10 | 0.45±0.15 | 0.50±0.20 |
| RC1218 | 3.10±0.10 | 4.60±0.10 | 0.55±0.10 | 0.45±0.20 | 0.40±0.20 |
| RC2010 | 5.00±0.10 | 2.50±0.15 | 0.55±0.10 | 0.45±0.15 | 0.50±0.20 |
| RC2512 | 6.35±0.10 | 3.10±0.15 | 0.55±0.10 | 0.60±0.20 | 0.50±0.20 |

ELECTRICAL CHARACTERISTICS

Table 2

| CHARACTERISTICS | POWER | OPERATING TEMPERATURE RANGE | MAXIMUM WORKING VOLTAGE | MAXIMUM OVERLOAD VOLTAGE | DIELECTRIC WITHSTANDING VOLTAGE | RESISTANCE RANGE | TEMPERATURE COEFFICIENT | JUMPER CRITERIA |
|-----------------|--------|-----------------------------|-------------------------|--------------------------|---------------------------------|--|---|--|
| RC0075 | 1/50 W | -55°C to 125°C | 10V | 25V | 25V | 5% (E24) 10Ω ≤ R ≤ 1MΩ 1% (E24/E96) 10Ω ≤ R ≤ 1MΩ Jumper < 50mΩ | 10Ω ≤ R < 100Ω -200~+600ppm/°C 100Ω ≤ R ≤ 1MΩ ±200ppm/°C | Rated Current 0.5A Maximum Current 1.0A |
| RC0100 | 1/32 W | -55°C to 125°C | 15V | 30V | 30V | 5% (E24) 1Ω ≤ R ≤ 22MΩ 1% (E24/E96) 1Ω ≤ R ≤ 10MΩ 0.5% (E24/E96) 33Ω ≤ R ≤ 470KΩ Jumper < 50mΩ | 1Ω ≤ R < 100Ω -200~+600ppm/°C 10Ω ≤ R < 100Ω: ±300ppm/°C 100Ω ≤ R ≤ 10MΩ: ±200ppm/°C 10MΩ < R ≤ 22MΩ: ±250ppm/°C | Rated Current 0.5A Maximum Current 1.0A |
| RC0201 | 1/20 W | -55°C to 125°C | 25V | 50V | 50V | 5% (E24) 1Ω ≤ R ≤ 10MΩ 1% (E24/E96) 1Ω ≤ R ≤ 10MΩ 0.1%, 0.5% (E24/E96) 10Ω ≤ R ≤ 1MΩ Jumper < 50mΩ | 1Ω ≤ R ≤ 10Ω -100~+350ppm/°C 10Ω < R ≤ 10MΩ ±200ppm/°C | Rated Current 0.5A Maximum Current 1.0A |

Table 2

| CHARACTERISTICS | POWER | OPERATING TEMPERATURE RANGE | MAXIMUM WORKING VOLTAGE | MAXIMUM OVERLOAD VOLTAGE | DIELECTRIC WITHSTANDING VOLTAGE | RESISTANCE RANGE | TEMPERATURE COEFFICIENT | JUMPER CRITERIA |
|-----------------|--------|-----------------------------|-------------------------|--------------------------|---------------------------------|---|---|---|
| RC0402 | 1/16 W | -55°C to 155°C | 50V | 100V | 100V | 5% (E24) 1Ω≤R≤22MΩ 1% (E24/E96) 1Ω≤R≤10MΩ 0.1%, 0.5% (E24/E96) 10Ω≤R≤1MΩ Jumper<50mΩ | 1Ω≤R≤10Ω ±200ppm°C 10Ω<R≤10MΩ ±100ppm°C 10MΩ<R≤22MΩ ±200ppm°C | Rated Current 1.0A Maximum Current 2.0A |
| | 1/8W | -55°C to 155°C | 50V | 100V | 100V | 5% (E24) 1Ω≤R≤1MΩ 1% (E24/E96) 1Ω≤R≤1MΩ | 1Ω≤R≤1MΩ ±200ppm°C | |
| RC0603 | 1/10 W | -55°C to 155°C | 75V | 150V | 150V | 5% (E24) 1Ω≤R≤22MΩ 1% (E24/E96) 1Ω≤R≤10MΩ 0.1%, 0.5% (E24/E96) 10Ω≤R≤1MΩ Jumper<50mΩ | 1Ω≤R≤10Ω ±200ppm°C 10Ω<R≤10MΩ ±100ppm°C 10MΩ<R≤22MΩ ±200ppm°C | Rated Current 1.0A Maximum Current 2.0A |
| | 1/5 W | -55°C to 155°C | 75V | 150V | 150V | 5% (E24) 1Ω≤R≤1MΩ 1% (E24/E96) 1Ω≤R≤1MΩ | 1Ω≤R≤1MΩ ±200ppm°C | |
| RC0805 | 1/8 W | -55°C to 155°C | 150V | 300V | 300V | 5% (E24) 1Ω≤R≤100MΩ 1% (E24/E96) 1Ω≤R≤10MΩ 0.1%, 0.5% (E24/E96) 10Ω≤R≤1MΩ 10%, 20% (E24) 24MΩ≤R≤100MΩ Jumper<50mΩ | 1Ω≤R≤10Ω ±200ppm°C 10Ω<R≤10MΩ ±100ppm°C 10MΩ<R≤22MΩ ±200ppm°C 24MΩ<R≤100MΩ ±300ppm°C | Rated Current 2.0A Maximum Current 5.0A |
| | 1/4 W | -55°C to 155°C | 150V | 300V | 300V | 5% (E24) 1Ω≤R≤1MΩ 1% (E24/E96) 1Ω≤R≤1MΩ | 1Ω≤R≤1MΩ ±200ppm°C | |
| RC1206 | 1/4 W | -55°C to 155°C | 200V | 400V | 500V | 5% (E24) 1Ω≤R≤100MΩ 1% (E24/E96) 1Ω≤R≤10MΩ 0.1%, 0.5% (E24/E96) 10Ω≤R≤1MΩ 10%, 20% (E24) 24MΩ≤R≤100MΩ Jumper<50mΩ | 1Ω≤R≤10Ω ±200ppm°C 10Ω<R≤10MΩ ±100ppm°C 10MΩ<R≤22MΩ ±200ppm°C 24MΩ≤R≤100MΩ ±300ppm°C | Rated Current 2.0A Maximum Current 10.0A |
| | 1/2 W | -55°C to 155°C | 200V | 400V | 500V | 5% (E24) 1Ω≤R≤1MΩ 1% (E24/E96) 1Ω≤R≤1MΩ | 1Ω≤R≤1MΩ ±200ppm°C | |

FOOTPRINT AND SOLDERING PROFILES

For recommended footprint and soldering profiles, please refer to data sheet “Chip resistors mounting”

Table 2

| CHARACTERISTICS | POWER | OPERATING TEMPERATURE RANGE | MAXIMUM WORKING VOLTAGE | MAXIMUM OVERLOAD VOLTAGE | DIELECTRIC WITHSTANDING VOLTAGE | RESISTANCE RANGE | TEMPERATURE COEFFICIENT | JUMPER CRITERIA |
|-----------------|-------|-----------------------------|-------------------------|--------------------------|---------------------------------|-----------------------------------|--------------------------|--------------------------|
| RC1210 | 1/2 W | -55°C to 155°C | 200V | 500V | 500V | 5% (E24) 1Ω≤R≤22MΩ | 1Ω≤R≤10Ω ±200ppm°C | Rated Current 2.0A |
| | | | | | | 1% (E24/E96) 1Ω≤R≤10MΩ | 10Ω<R≤10MΩ ±100ppm°C | Maximum Current 10.0A |
| RC1218 | 1 W | -55°C to 155°C | 200V | 500V | 500V | 0.1%, 0.5% (E24/E96) 10Ω≤R≤1MΩ | 10MΩ<R≤22MΩ ±200ppm°C | Rated Current 6.0A |
| | | | | | | 1% (E24/E96) 1Ω≤R≤1MΩ | 10Ω<R≤1MΩ ±100ppm°C | Maximum Current 10.0A |
| RC2010 | 3/4 W | -55°C to 155°C | 200V | 500V | 500V | 5% (E24) 1Ω≤R≤22MΩ | 1Ω≤R≤10Ω ±200ppm°C | Rated Current 2.0A |
| | | | | | | 1% (E24/E96) 1Ω≤R≤10MΩ | 10Ω<R≤10MΩ ±100ppm°C | Maximum Current 10.0A |
| RC2512 | 1 W | -55°C to 155°C | 200V | 500V | 500V | 0.1%, 0.5% (E24/E96) 10Ω≤R≤1MΩ | 10MΩ<R≤22MΩ ±200ppm°C | Rated Current 2.0A |
| | | | | | | 1% (E24/E96) 1Ω≤R≤1MΩ | 10Ω<R≤10MΩ ±100ppm°C | Maximum Current 10.0A |
| | 2 W | -55°C to 155°C | 200V | 400V | 500V | 5% (E24) 1Ω≤R≤1MΩ | 1Ω≤R≤1MΩ ±200ppm°C | |

PACKING STYLE AND PACKAGING QUANTITY

Table 3 Packing style and packaging quantity

| PACKING STYLE | PAPER TAPING REEL (R) | | | ESD SAFE REEL (S) (4MM WIDTH, 1MM PITCH PLASTIC EMBOSSSED) | EMBOSSSED TAPING REEL |
|----------------|-----------------------|-------------|--------------|---|--------------------------|
| | 7" (178 mm) | 10" (254mm) | 13" (330 mm) | | |
| REEL DIMENSION | 7" (178 mm) | 10" (254mm) | 13" (330 mm) | 7" (178 mm) | 7" (178 mm) |
| RC0075 | --- | --- | --- | 20000 | --- |
| RC0100 | 20000 | --- | 80000 | 40000 | --- |
| RC0201 | 10000 | 20000 | 50000 | --- | --- |
| RC0402 | 10000 | 20000 | 50000 | --- | --- |
| RC0603 | 5000 | 10000 | 20000 | --- | --- |
| RC0805 | 5000 | 10000 | 20000 | --- | --- |
| RC1206 | 5000 | 10000 | 20000 | --- | --- |
| RC1210 | 5000 | 10000 | 20000 | --- | --- |
| RC1218 | --- | --- | --- | --- | 4000 |
| RC2010 | --- | --- | --- | --- | 4000 |
| RC2512 | --- | --- | --- | --- | 4000 |

NOTE

For tape and reel specification/dimensions, please refer to data sheet "Chip resistors packing".

FUNCTIONAL DESCRIPTION

OPERATING TEMPERATURE RANGE

RC0402 to RC2512 Range: -55°C to +155°C (Fig. 7-1)

RC0075 to RC0201 Range: -55°C to +125°C (Fig. 7-2)

POWER RATING

Each type rated power at 70 °C:

- RC0075=1/50W
- RC0100=1/32W
- RC0201=1/20W
- RC0402=1/16W, 1/8W
- RC0603=1/10W, 1/5W
- RC0805=1/8W, 1/4W
- RC1206=1/4W, 1/2W
- RC1210=1/2W
- RC1218=1W
- RC2010=3/4W
- RC2512=1W, 2W

RATED VOLTAGE

The DC or AC (rms) continuous working voltage corresponding to the rated power is determined by the following formula:

$$V = \sqrt{(P \times R)}$$

or max. working voltage whichever is less

Where

V = Continuous rated DC or AC (rms) working voltage (V)

P = Rated power (W)

R = Resistance value (Ω)

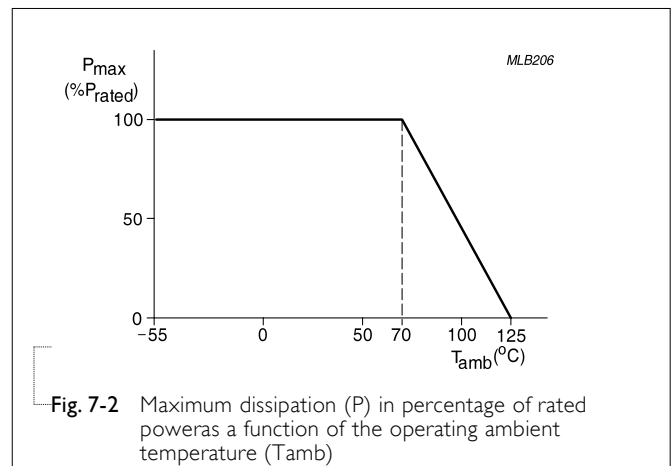
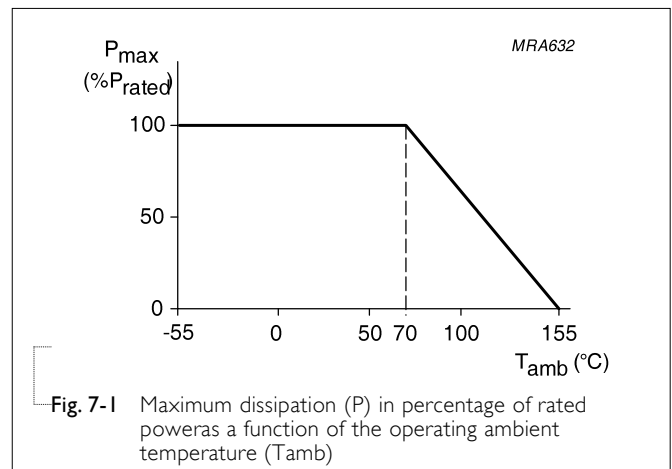

TESTS AND REQUIREMENTS

Table 8 Test condition, procedure and requirements

| TEST | TEST METHOD | PROCEDURE | REQUIREMENTS |
|--|---|---|--|
| Temperature Coefficient of Resistance (T.C.R.) | MIL-STD-202 Method 304 | At +25/-55°C and +25/+125°C Formula: $T.C.R = \frac{R_2 - R_1}{R_1(t_2 - t_1)} \times 10^6 \text{ (ppm/°C)}$ Where t ₁ =+25 °C or specified room temperature t ₂ =-55 °C or +125 °C test temperature R ₁ =resistance at reference temperature in ohms R ₂ =resistance at test temperature in ohms | Refer to table 2 |
| Life/ Endurance | MIL-STD-202 Method 108A IEC 60115-1 4.25.1 | At 70±2°C for 1,000 hours; RCWV applied for 1.5 hours on and 0.5 hour off, still air required | 0075: ± (5%+100mΩ) <100mΩ for jumper 01005: ±(3% +50mΩ) <100mΩf or jumper Others: ±(1%+50mΩ) for B/D/F tol ±(3%+50mΩ) for J tol <100mR for jumper |
| High Temperature Exposure | MIL-STD-202 Method 108A IEC 60068-2-2 | 1,000 hours at maximum operating temperature depending on specification, unpowered. | 0075: ± (5%+100mΩ) <100mΩ for jumper 01005: ±(1% +50mΩ) < 50mΩf or jumper Others: ±(1%+50mΩ) for B/D/F tol ±(2%+50mΩ) for J tol <50mR for jumper |
| Moisture Resistance | MIL-STD-202 Method 106G | Each temperature / humidity cycle is defined at 8 hours (method 106F), 3 cycles / 24 hours for 10d with 25°C / 65°C 95% R.H, without steps 7a & 7b, unpowered Parts mounted on test-boards, without condensation on parts | 0075: ± (2%+100mΩ) <100mΩ for jumper 01005: ±(2% +50mΩ) < 100mΩf or jumper Others: ±(0.5%+50mΩ) for B/ D/F tol ±(2%+50mΩ) for J tol <100mR for jumper |
| Humidity | IEC 60115-1 4.24.2 | Steady state for 1000 hours at 40°C / 95% R.H. RCWV applied for 1.5 hours on and 0.5 hour off | 0075: ± (5%+100mΩ) no visible damage 01005: ±(3% +50mΩ) < 100mΩf or jumper Others: ±(1%+50mΩ) for B/D/F tol ±(2%+50mΩ) for J tol <100mR for jumper |

| | | | |
|--------------------------------------|---|--|---|
| Thermal Shock | MIL-STD-202 Method 107G | -55/+125°C Note Number of cycles required is 300. Devices mounted Maximum transfer time is 20 seconds. Dwell time is 15 minutes. Air - Air | 0075/01005: $\pm(1\% + 50m\Omega)$ < 50m Ω f or jumper Others: $\pm(0.5\% + 50m\Omega)$ for B/D/F tol $\pm(1\% + 50m\Omega)$ for J tol < 50mR for jumper |
| Short Time Overload | IEC 60115-1 4.13 | 2.5 times RCWV or maximum overload voltage which is less for 5 seconds at room temperature | 0075/01005: $\pm(2\% + 50m\Omega)$ < 50m Ω f or jumper Others: $\pm(1\% + 50m\Omega)$ for B/D/F tol $\pm(2\% + 50m\Omega)$ for J tol <50mR for jumper No visible damage |
| Board Flex/Bending | IEC 60115-1 4.33 | Device mounted or as described only 1 board bending required bending time: 60 \pm 5 seconds 0075/0100/0201/0402:5mm; 0603/0805:3mm; 1206 and above:2mm | 0075/01005: $\pm(1\% + 50m\Omega)$ < 50m Ω f or jumper Others: $\pm(1\% + 50m\Omega)$ for B/D/F/J tol <50mR for jumper No visible damage |
| Solderability - Wetting | J-STD-002 test B | Electrical Test not required Magnification 50X SMD conditions: 1st step: method B, aging 4 hours at 155°C dry heat 2nd step: leadfree solder bath at 245 \pm 3°C Dipping time: 3 \pm 0.5 seconds | Well tinned (>95% covered) No visible damage |
| -Leaching | J-STD-002 test D | Leadfree solder ,260°C, 30 seconds immersion time | No visible damage |
| -Resistance to Soldering Heat | MIL-STD-202 Method 210F IEC 60115-1 4.18 | Condition B, no pre-heat of samples Leadfree solder, 260°C \pm 5°C, 10 \pm 1 seconds immersion time Procedure 2 for SMD: devices fluxed and cleaned with isopropanol | 0075: $\pm(3\% + 50m\Omega)$ <50m Ω for jumper 01005: $\pm(1\% + 50m\Omega)$ < 50m Ω f or jumper Others: $\pm(0.5\% + 50m\Omega)$ for B/D/F tol. $\pm(1\% + 50m\Omega)$ for J tol. <50mR for jumper No visible damage |

REVISION HISTORY

| REVISION | DATE | CHANGE NOTIFICATION | DESCRIPTION |
|-----------|---------------|---------------------|--|
| Version 7 | Mar. 7, 2017 | - | - Add 10" packing |
| Version 6 | Feb.15, 2017 | - | - Extend RC0805 and RC1206 resistance range to 100Mohm |
| Version 5 | Oct. 06, 2016 | - | - Description: Update Dimension of I2 of RC2512 (2W) |
| Version 4 | Jan. 22, 2016 | - | - update resistance range |
| Version 3 | Dec. 24, 2015 | - | - Updated test and requirements |
| Version 2 | Jul. 23, 2015 | - | - Updated test and requirements |
| Version 1 | Jan. 21, 2015 | - | - ESD Safe Reel update |
| Version 0 | Dec. 15, 2014 | - | - First issue of this specification |

“Yageo reserves all the rights for revising the content of this datasheet without further notification, as long as the products itself are unchanged. Any product change will be announced by PCN.”