

阅读申明

- 1.本站收集的数据手册和产品资料都来自互联网，版权归原作者所有。如读者和版权方有任何异议请及时告之，我们将妥善解决。
- 2.本站提供的中文数据手册是英文数据手册的中文翻译，其目的是协助用户阅读，该译文无法自动跟随原稿更新，同时也可能存在翻译上的不当。建议读者以英文原稿为参考以便获得更精准的信息。
- 3.本站提供的产品资料，来自厂商的技术支持或者使用者的心得体会等，其内容可能存在描述上的差异，建议读者做出适当判断。
- 4.如需与我们联系，请发邮件到marketing@iczoom.com，主题请标有“数据手册”字样。

Read Statement

1. The datasheets and other product information on the site are all from network reference or other public materials, and the copyright belongs to the original author and original published source. If readers and copyright owners have any objections, please contact us and we will deal with it in a timely manner.
2. The Chinese datasheets provided on the website is a Chinese translation of the English datasheets. Its purpose is for reader's learning exchange only and do not involve commercial purposes. The translation cannot be automatically updated with the original manuscript, and there may also be improper translations. Readers are advised to use the English manuscript as a reference for more accurate information.
3. All product information provided on the website refer to solutions from manufacturers' technical support or users the contents may have differences in description, and readers are advised to take the original article as the standard.
4. If you have any questions, please contact us at marketing@iczoom.com and mark the subject with "Datasheets" .

INTRODUCTION:

Adam Tech right angle PCB mount .318" footprint D-Sub connectors are a popular interface for many I/O applications. Offered in 9, 15, 25 and 37 positions they are a good choice for a low cost industry standard connection. These connectors are manufactured with precision stamped contacts offering a choice of contact plating and a wide selection of mating and mounting options.

FEATURES:

- Industry standard compatibility
- Durable metal shell design
- Precision formed contacts
- Variety of Mating and mounting options

MATING CONNECTORS:

Adam Tech D-Subminiatures and all industry standard D-Subminiature connectors.

SPECIFICATIONS:

Material:

Standard insulator: PBT, 30% glass reinforced, rated UL94V-0
 Optional Hi-Temp insulator: Nylon 6T
 Insulator color: Black
 Contacts: Phosphor Bronze
 Shell: Steel, Tin or Zinc plated
 Hardware: Brass, Nickel plated

Contact Plating:

Gold over Nickel underplate on contact area.

Electrical:

Operating voltage: 250V AC / DC max.
 Current rating: 5 Amps max.
 Contact resistance: 20 mΩ max. initial
 Insulation resistance: 5000 MΩ min.
 Dielectric withstanding voltage: 1000V AC for 1 minute

Mechanical:

Insertion force: 0.75 lbs max
 Extraction force: 0.44 lbs min
 Temperature Rating:
 Operating temperature: -55°C to +105°C
 Soldering process temperature:
 Standard insulator: 235°C
 Hi-Temp insulator: 260°C

Packaging:

Anti-ESD plastic trays

Approvals and Certifications:

UL Recognized & CSA Certified, File no. E224053

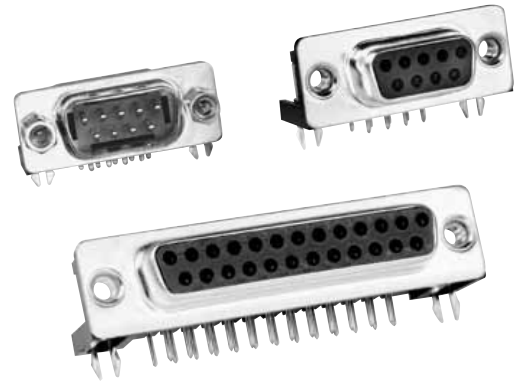

ORDERING INFORMATION



SHELL SIZE/ POSITIONS

DE09 = 9 Position
 DA15 = 15 Position
 DB25 = 25 Position
 DC37 = 37 Position

CONTACT TYPE

PL = Plug, .318" Footprint
 SL = Socket, .318" Footprint

MATING FACE MOUNTING OPTIONS

3 = #4-40 fixed jackscrews
 4 = #4-40 flush threaded inserts
 5 = #4-40 flush threaded inserts with removable jackscrews installed
 6 = .120" non-threaded mounting holes

* See Mounting Option diagrams pg. 77

PCB MOUNTING OPTIONS

1 = Wrap around ground straps with thru holes
 2 = Forked board locks
 3 = Top side only ground straps with thru holes
 4 = Top side only ground straps with #4-40 threaded screw holes

* See Mounting Option diagrams pg. 77

OPTIONS:

Add designator(s) to end of part number
 15 = 15 μin gold plating in contact area
 30 = 30 μin gold plating in contact area
 EMI = Ferrite filtered version for EMI/RFI suppression
 LPJ = Loose packed jackscrews
 F = Superior retention 4 prong boardlocks
 HT = Hi-Temp insulator for Hi-Temp soldering processes up to 260°C
 R = Round jackscrews
 PF = Press fit pins



PLUG

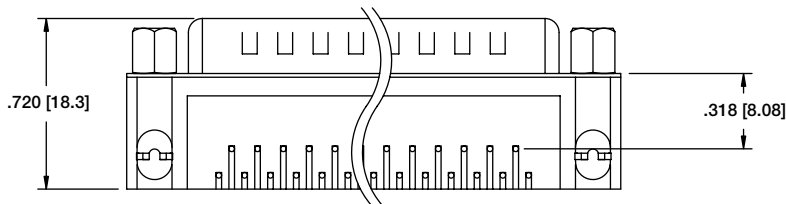
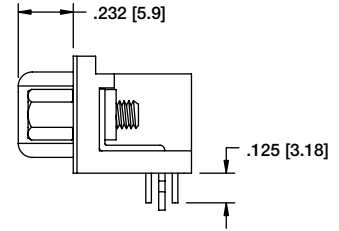
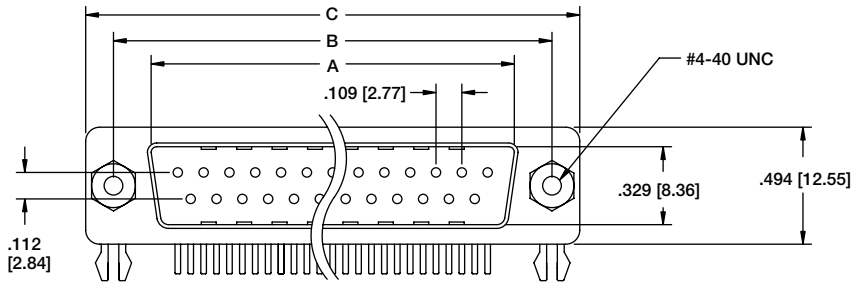

DB25-PL-25

SOCKET

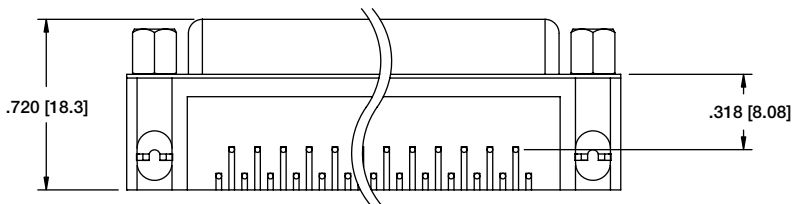
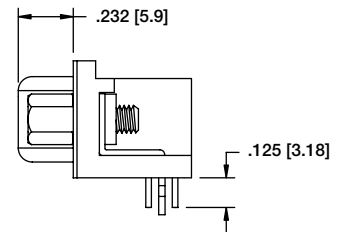
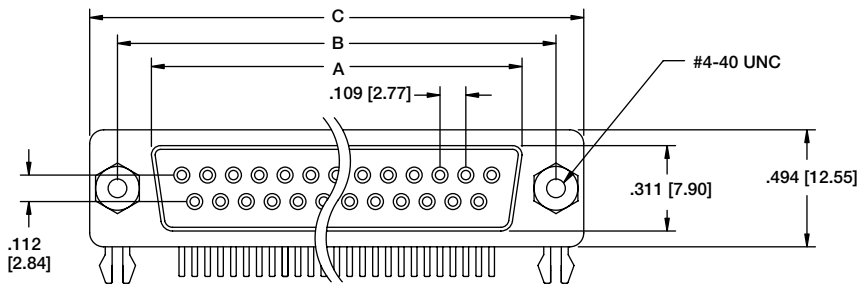

DB25-SL-24

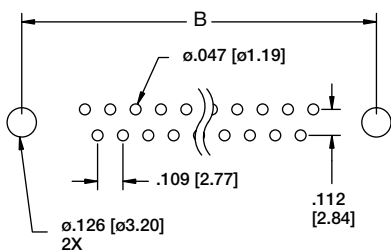

Recommended PCB Layout

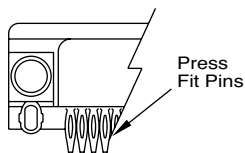

Press Fit Option

Unit: Inch [mm]

Pos.	PLUG	SOCKET	DIMENSIONS	
	A	A	B	C
9	.666 [16.92]	.643 [16.33]	.984 [24.99]	1.213 [30.81]
15	.994 [25.25]	.971 [24.66]	1.312 [33.32]	1.541 [39.14]
25	1.534 [38.96]	1.511 [38.38]	1.852 [47.04]	2.088 [53.04]
37	2.182 [55.43]	2.159 [54.84]	2.500 [63.50]	2.729 [69.32]

MATING FACE & PCB MOUNTING OPTIONS

OPTION 23

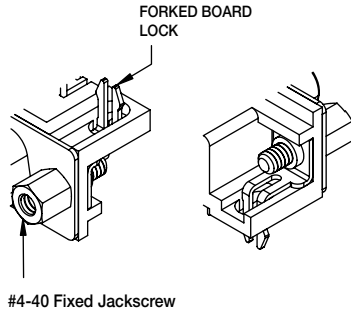

* Standard Stocked Item

OPTION 24

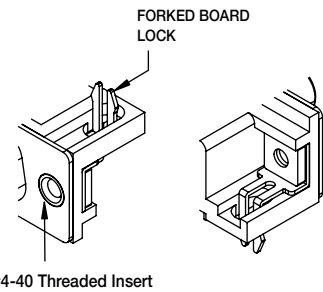

* Standard Stocked Item

OPTION 25

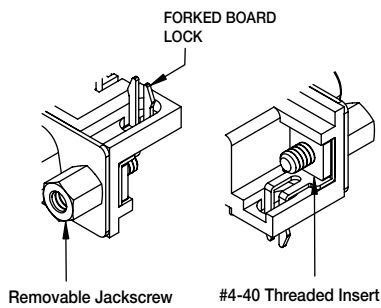

* Standard Stocked Item

OPTION 23-R

#4-40 Rivited Round Jackscrew (Shown)

OPTION 27

#4-40 Rivited Hex Jackscrew (Not Shown)

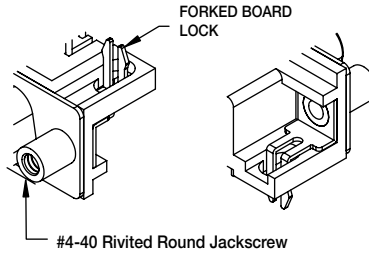

OPTION 26

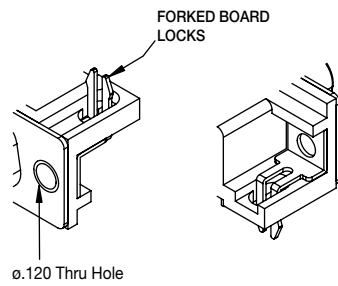

OPTION 34

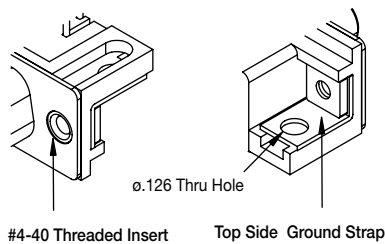

OPTION 36

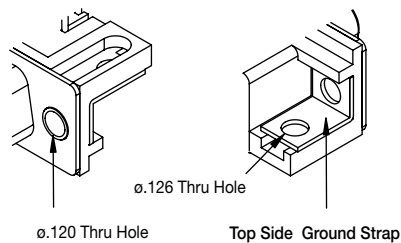

OPTION 24-F

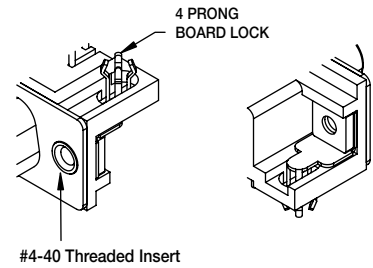

OPTION 33

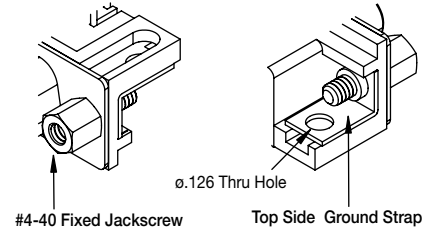

OPTION 35

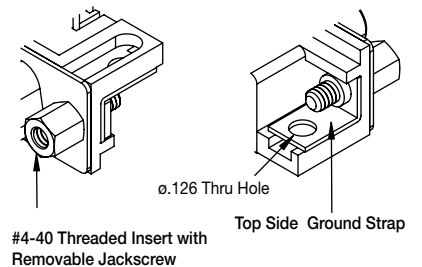

OPTION 43

