

阅读申明

- 1.本站收集的数据手册和产品资料都来自互联网，版权归原作者所有。如读者和版权方有任何异议请及时告之，我们将妥善解决。
- 2.本站提供的中文数据手册是英文数据手册的中文翻译，其目的是协助用户阅读，该译文无法自动跟随原稿更新，同时也可能存在翻译上的不当。建议读者以英文原稿为参考以便获得更精准的信息。
- 3.本站提供的产品资料，来自厂商的技术支持或者使用者的心得体会等，其内容可能存在描述上的差异，建议读者做出适当判断。
- 4.如需与我们联系，请发邮件到marketing@iczoom.com，主题请标有“数据手册”字样。

Read Statement

1. The datasheets and other product information on the site are all from network reference or other public materials, and the copyright belongs to the original author and original published source. If readers and copyright owners have any objections, please contact us and we will deal with it in a timely manner.
2. The Chinese datasheets provided on the website is a Chinese translation of the English datasheets. Its purpose is for reader's learning exchange only and do not involve commercial purposes. The translation cannot be automatically updated with the original manuscript, and there may also be improper translations. Readers are advised to use the English manuscript as a reference for more accurate information.
3. All product information provided on the website refer to solutions from manufacturers' technical support or users the contents may have differences in description, and readers are advised to take the original article as the standard.
4. If you have any questions, please contact us at marketing@iczoom.com and mark the subject with "Datasheets" .



Description

The 3AG Fast-Acting Fuse solves a broad range of application requirements while offering reliable performance and cost-effective circuit protection.

Features

- In accordance with UL Standard 248-14
- Available in cartridge and axial lead format and with various forming dimensions
- RoHS compliant and Lead-free (except 10mA and 31mA rated items)

Applications

Used as supplementary protection in appliance or utilization equipment to provide individual protection for components or internal circuits.







Agency Approvals

Agency	Agency File Number	Ampere Range
	E10480 AU1410	312 Series 10mA - 10A 318 Series 31mA - 10A 312 Series 12A - 30A
	LR 29862	312 Series 10mA - 30A 318 Series 31mA - 10A
	NBK040205- E10480B/F	312/318 Series 1A - 10A
	E10480	318 Series 12A - 30A
	SU05001- 5005/5006/6005/6008	312/318 Series 1A/ 1.25A / 1.6A/ 2A - 10A
		312 Series 10mA - 10A 318 Series 31mA - 35A

Electrical Characteristics for Series

% of Ampere Rating	Ampere Rating	Opening Time
100%	.01 – 35	4 hours, Minimum
135%	.01 – 35	1 hour, Maximum
200%	.01 – 10	5 sec., Maximum
	12 – 30	10 sec., Maximum
	35	20 sec., Maximum

Electrical Characteristic Specifications by Item

Amp Code	Ampere Rating (A)	Max Voltage Rating (V)	Interrupting Rating	Nominal Cold Resistance (Ohms)	Nominal Melting I ² t (A ² sec)	Agency Approvals					
											
.10*	0.01	250	10mA ~ 1A 35A@250Vac 10KA@125Vac	177.4000	NA	x**				x**	x**
.031*	0.031	250		23.6500	0.0000300	x				x	x
.062	0.062	250		24.7000	0.000249	x				x	x
.100	0.1	250		11.2800	0.00102	x				x	x
.125	0.125	250		7.1450	0.00289	x				x	x
.150	0.15	250		5.1300	0.00550	x				x	x
.175	0.175	250		3.8750	0.00960	x				x	x
.187	0.187	250		3.4200	0.0128	x				x	x
.200	0.2	250		3.0200	0.0165	x				x	x
.250	0.25	250		2.0100	0.0355	x				x	x
.300	0.3	250		1.4050	0.0689	x				x	x
.375	0.375	250		0.8250	0.185	x				x	x
.500	0.5	250		0.4980	0.483	x				x	x
.600	.6	250		0.3620	0.880	x				x	x
.750	0.75	250		0.2445	1.84	x				x	x
001	1	250		0.1900	0.760	x		x	x	x	x
1.25	1.25	250		0.1385	1.45	x		x	x	x	x
01.5	1.5	250		0.1036	2.35	x			x	x	x
01.6	1.6	250		0.0934	2.80	x		x	x	x	x
1.75	1.75	250		0.0856	3.60	x			x	x	x
01.8	1.8	250	0.0825	3.85	x			x	x	x	
002	2	250	0.0704	5.20	x		x	x	x	x	
2.25	2.25	250	0.0594	7.20	x		x	x	x	x	
02.5	2.5	250	0.0513	9.54	x		x	x	x	x	
003	3	250	0.0427	14.0	x		x	x	x	x	
004	4	250	0.0293	28.5	x		x	x	x	x	
005	5	250	0.0224	50.0	x		x	x	x	x	
006	6	250	0.0178	118.0	x		x	x	x	x	
007	7	250	0.0146	118.0	x		x	x	x	x	
008	8	250	0.0122	166.0	x		x	x	x	x	
010	10	250	0.0093	298.0	x		x	x	x	x	
012	12	32	0.0072	234.6	x**	x***			x**		
015	15	32	0.0052	490.5	x**	x***			x**		
020	20	32	0.0035	1029	x**	x***			x**		
025	25	32	0.0024	2041	x**	x***			x**		
030	30	32	0.0019	3717	x**	x***			x**		
035	35	32	0.0013	7531							

NOTES:

* 10mA and 31mA are not RoHS compliant as the glass bead contains Pb.

** 312 Series only. Refer to Agency Approvals section of this document.

*** 318 Series only. Refer to Agency Approvals section of this document.

Temperature Derating Curve

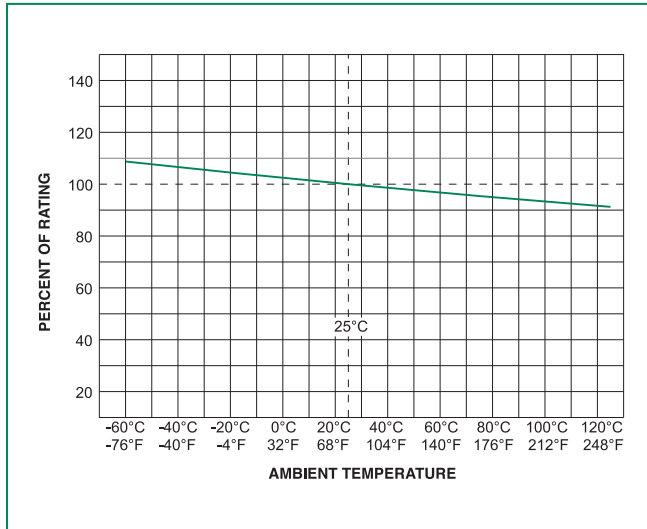

Average Time Current Curves

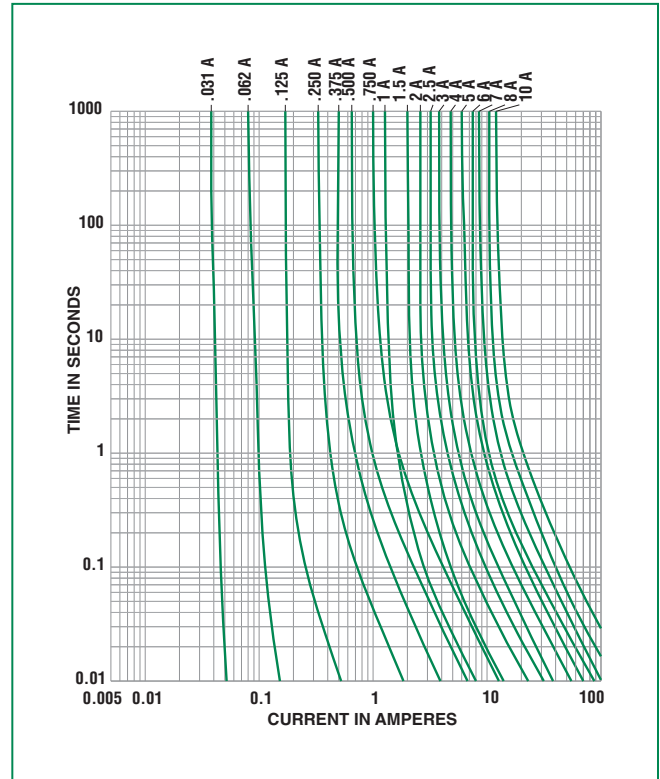

Soldering Parameters - Wave Soldering

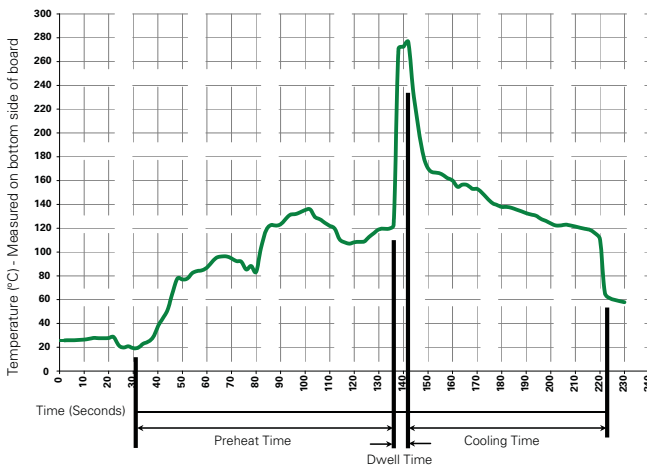

Recommended Process Parameters:

Wave Parameter	Lead-Free Recommendation
Preheat: (Depends on Flux Activation Temperature) (Typical Industry Recommendation)	
Temperature Minimum:	100° C
Temperature Maximum:	150° C
Preheat Time:	60-180 seconds
Solder Pot Temperature:	280° C Maximum
Solder Dwell Time:	2-5 seconds

Recommended Hand-Solder Parameters:

Solder Iron Temperature: 350° C +/- 5° C
 Heating Time: 5 seconds max.

Note: These devices are not recommended for IR or Convection Reflow process.

Product Characteristics

Materials	Body: Glass Cap: Nickel-plated brass Leads: Tin-plated Copper
Terminal Strength	MIL-STD-202G, Method 211A, Test Condition A
Solderability	Reference IEC 60127 Second Edition 2003-01 Annex A
Product Marking	Cap1: Brand logo, current and voltage ratings Cap2: Series and agency approval marks

Operating Temperature	-55°C to +125°C
Thermal Shock	MIL-STD-202G, Method 107G, Test Condition B: (5 cycles -65°C to +125°C)
Vibration	MIL-STD-202G, Method 201 A
Humidity	MIL-STD-202G, Method 103B, Test Condition A: High RH (95%), and Elevated temperature (40°C) for 240 hours
Salt Spray	MIL-STD-202G, Method 101D, Test Condition B

Part Numbering System

0312 xxxx M X CC

Series

312 = Cartridge
318 = Axial Leaded

Current Rating Code

Refer to Amp Code column of Electrical Characteristics Table

Quantity Code

M = 1000
H = 100
V = 5

Packaging Code

X = Loose Pack

Option Codes

Blank = Standard Item
CC = Color Coded
SL = Short Lead Option (12.70 +/- 1.575 mm)
P = RoHS Compliant and Lead Free Indicator *

For additional information or information about other available options, please contact Littelfuse.

*Note: All 312 / 318 series fuses are now sold as RoHS compliant and Lead Free by default, with or without the "P" indicator.

Dimensions

Measurements displayed in millimeters (inches)

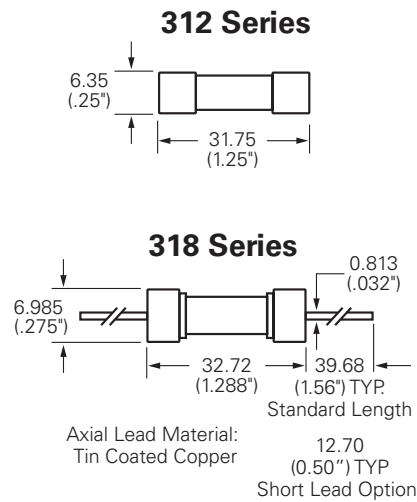

Packaging

Packaging Option	Quantity	Quantity & Packaging Code
312 Series (Cartridge Type)		
Bulk	5	VX
Bulk	100	HX
Bulk	1000	MX
Bulk	1000	MXCC
Bulk	100	HXCC
318 Series (Axial Leaded)		
Bulk	5	VX
Bulk	100	HX
Bulk	1000	MX
Bulk	1000	MXSL