

阅读申明

- 1.本站收集的数据手册和产品资料都来自互联网，版权归原作者所有。如读者和版权方有任何异议请及时告之，我们将妥善解决。
- 2.本站提供的中文数据手册是英文数据手册的中文翻译，其目的是协助用户阅读，该译文无法自动跟随原稿更新，同时也可能存在翻译上的不当。建议读者以英文原稿为参考以便获得更精准的信息。
- 3.本站提供的产品资料，来自厂商的技术支持或者使用者的心得体会等，其内容可能存在描述上的差异，建议读者做出适当判断。
- 4.如需与我们联系，请发邮件到marketing@iczoom.com，主题请标有“数据手册”字样。

Read Statement

1. The datasheets and other product information on the site are all from network reference or other public materials, and the copyright belongs to the original author and original published source. If readers and copyright owners have any objections, please contact us and we will deal with it in a timely manner.
2. The Chinese datasheets provided on the website is a Chinese translation of the English datasheets. Its purpose is for reader's learning exchange only and do not involve commercial purposes. The translation cannot be automatically updated with the original manuscript, and there may also be improper translations. Readers are advised to use the English manuscript as a reference for more accurate information.
3. All product information provided on the website refer to solutions from manufacturers' technical support or users the contents may have differences in description, and readers are advised to take the original article as the standard.
4. If you have any questions, please contact us at marketing@iczoom.com and mark the subject with "Datasheets" .

Multilayer Varistor for ESD pulse [DC voltage lines/High speed signal lines]

Series : **EZJZ, EZJP**

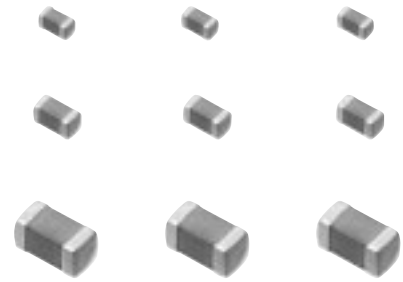

■ Features

- Excellent ESD suppression due to advanced material technology
 - Meets IEC61000-4-2, Level 4 standard
 - Can replace 2 Zener Diodes and 1 Capacitor
 - Low capacitance versions for DC voltage lines of high speed busses
 - Ultra low capacitance for signal lines of high speed busses
 - Ideal usage for USB 2.0, IEEE1394, and HDMI high speed data busses
- RoHS compliant

■ Handling Precautions

Please see pages 291 to 296

■ Packaging Methods

Please see pages 290, 360

■ Explanation of Part Numbers

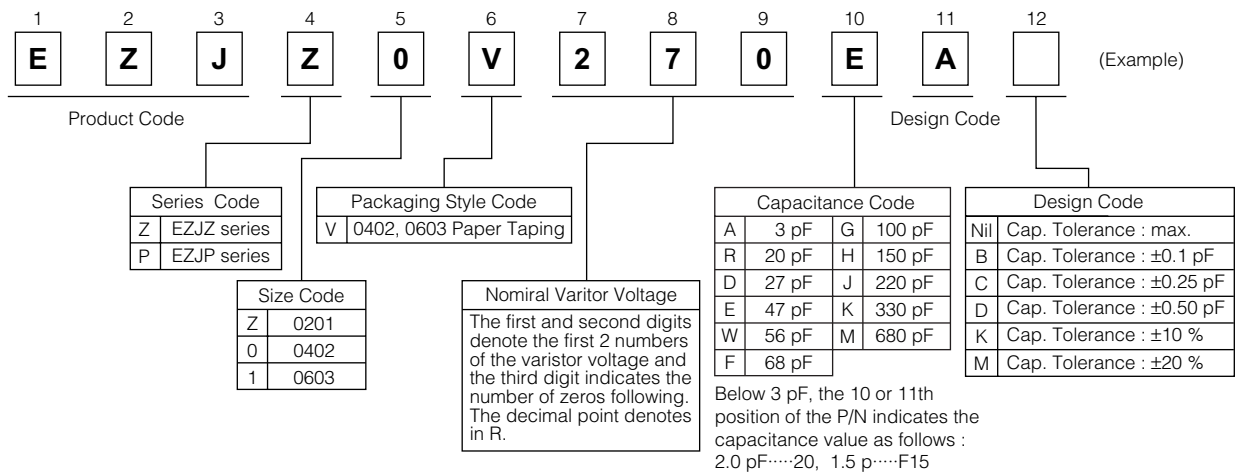

■ Construction

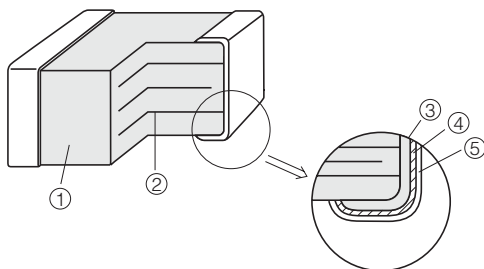

No.	Name
①	Semiconductive Ceramics
②	Internal electrode
③	Substrate electrode
④	Terminal electrode
⑤	External electrode

■ Dimensions in mm (not to scale)

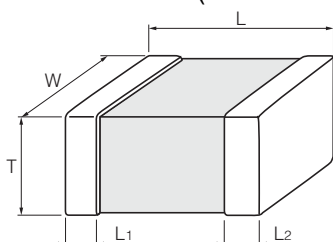

Size Code	Size (inch)	L	W	T	L ₁ , L ₂
Z	0201	0.60±0.03	0.30±0.03	0.30±0.03	0.15±0.05
0	0402	1.00±0.05	0.50±0.05	0.50±0.05	0.2±0.1
1	0603	1.6±0.1	0.8±0.1	0.8±0.1	0.3±0.2

Multilayer Varistor, Low Capacitance Type [High speed signal lines]

■ Features

- Multilayer monolithic ceramic construction for high speed signal lines
- Ideal usage for USB 2.0, IEEE1394, and HDMI high speed data busses
- Capacitance : 0.8 to 2.1 pF typ.

■ Recommended Applications

Mobile phone	Antenna circuit, External IF
DSC, DVC	USB2.0, IEEE1394
PC, PDA	USB2.0, IEEE1394, LAN1000BASE
TV, DVD	USB2.0, IEEE1394, HDMI
Game console	Controller, External IF

■ Ratings and Characteristics

Size	Part No.	Maximum allowable voltage DC (V)	Nominal varistor voltage at 1mA (V)	Capacitance (pF) at 1MHz	Maximum ESD IEC61000-4-2
0402	EZJZ0V80010	10	80	1 max. [0.8 typ.]	Contact discharge : 8kV
	EZJZ0V80015D	5	80	1.5±0.5	
	EZJZ0V500AA	5	50	3 max. [2.1 typ.]	
	EZJZ0V800AA	18	80	3 max. [2.1 typ.]	
	EZJZ0V171AA	18	170	3 max. [2.1 typ.]	
0603	EZJZ1V80010	10	80	1 max. [0.8 typ.]	
	EZJZ1V500AA	5	50	3 max. [2.1 typ.]	
	EZJZ1V800AA	18	80	3 max. [2.1 typ.]	
	EZJZ1V171AA	18	170	3 max. [2.1 typ.]	

- Operating Temperature Range : -40 to 85 °C
- * Recommend soldering method : Reflow soldering

■ Voltage vs. Current

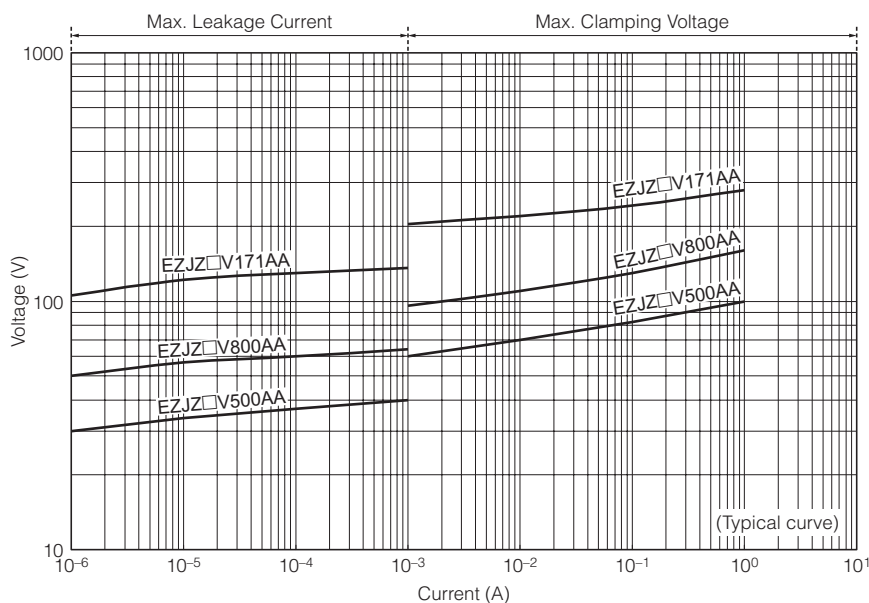

Design and specifications are each subject to change without notice. Ask factory for the current technical specifications before purchase and/or use. Should a safety concern arise regarding this product, please be sure to contact us immediately.

■ Frequency vs. Capacitance

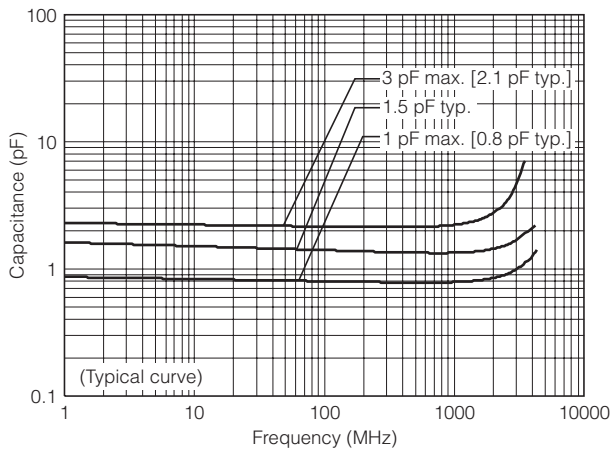

■ Frequency vs. Impedance

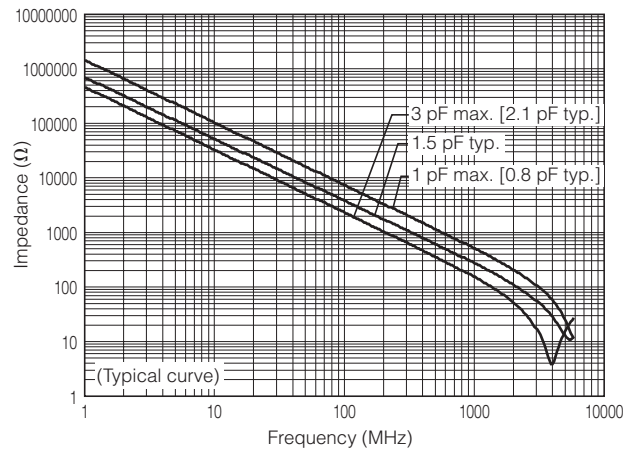

■ Frequency vs. Transmission

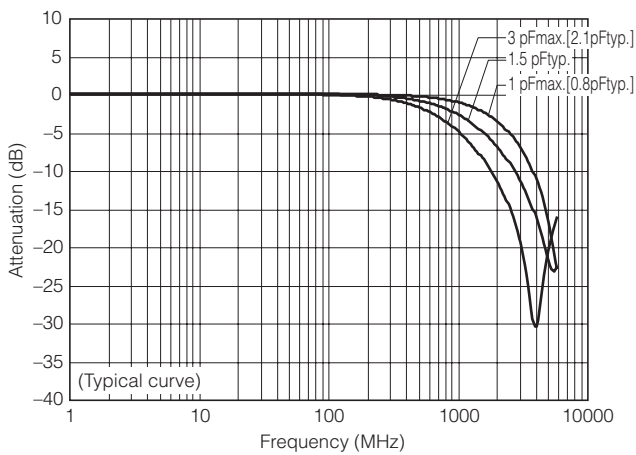

Multilayer Varistor, Low Voltage Type (Standard Type) [DC voltage lines/Low speed signal lines]

■ Features

Multilayer monolithic ceramic construction for use protecting DC voltage lines or signal lines

● Circuit voltage

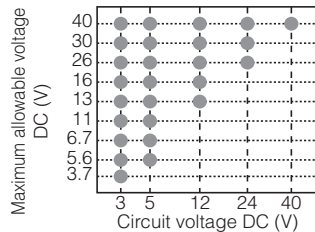

● Varistor voltage : 6.8 to 65 V [at 1 mA]

● Capacitance : 8.5 to 420 pF typ. [at 1 MHz]

■ Ratings and Characteristics

Size	Part No.	Maximum allowable voltage DC (V)	Nominal varistor voltage at 1mA (V)	Capacitance (pF)		Maximum peak current at 8/20μs, 2times (A)	Maximum ESD IEC61000-4-2
				at 1MHz	at 1kHz		
0201	EZJPZV6R8JA	3.7	6.8	220 max. [180 typ.]	175 typ.	5	Contact discharge 8 kV
	EZJPZV6R8GA	3.7	6.8	100 max. [85 typ.]	100 typ.	5	
	EZJPZV080GA	5.6	8	100 max. [85 typ.]	100 typ.	5	
	EZJPZV120GA	7.5	12	100 max. [85 typ.]	100 typ.	5	
	EZJPZV120DA	7.5	12	27 max. [22 typ.]	33 typ.	1	
	EZJPZV120RA	7.5	12	20 max. [15 typ.]	18 typ.	1	
	EZJPZV150RA	9	15	20 max. [15 typ.]	18 typ.	1	
	EZJPZV270RA	16	27	20 max. [15 typ.]	16.5 typ.	1	
	EZJPZV270BA	16	27	10 max. [8.5 typ.]	10 typ.	1	
0402	EZJP0V6R8MA	3.7	6.8	680 max. [420 typ.]	650 typ.	20	
	EZJP0V6R8GA	3.7	6.8	100 max. [85 typ.]	100 typ.	3	
	EZJP0V080MA	5.6	8	680 max. [420 typ.]	650 typ.	20	
	EZJP0V080KA	5.6	8	330 max. [290 typ.]	480 typ.	15	
	EZJP0V080GA	5.6	8	100 max. [65 typ.]	100 typ.	3	
	EZJP0V080DA	5.6	8	27 max. [22 typ.]	33 typ.	1	
	EZJZ0V120JA	6.7	12	220 max. [150 typ.]	175 typ.	10	
	EZJZ0V180HA	11	18	150 max. [120 typ.]	140 typ.	10	
	EZJZ0V220HA	13	22	150 max. [100 typ.]	116 typ.	10	
	EZJP0V270EA	16	27	47 max. [33 typ.]	37 typ.	4	
	EZJP0V270RA	16	27	20 max. [15 typ.]	16.5 typ.	1	
	EZJZ0V420WA	30	42	56 max. [40 typ.]	45 typ.	10	
EZJZ0V650DA	40	65	27 max. [22 typ.]	33 typ.	5		
0603	EZJZ1V120KA	6.7	12	330 max. [250 typ.]	290 typ.	20	
	EZJZ1V180JA	11	18	220 max. [180 typ.]	210 typ.	20	
	EZJZ1V220JA	13	22	220 max. [160 typ.]	185 typ.	20	
	EZJZ1V270GA	16	27	100 max. [85 typ.]	100 typ.	20	
	EZJZ1V270EA	16	27	47 max. [33 typ.]	37 typ.	20	
	EZJZ1V270RA	16	27	20 max. [15 typ.]	16.5 typ.	3	
	EZJZ1V330GA	26	33	100 max. [85 typ.]	100 typ.	20	
	EZJZ1V420FA	30	42	68 max. [55 typ.]	63 typ.	15	
	EZJZ1V650DA	40	65	27 max. [22 typ.]	33 typ.	5	

● Operating Temperature Range : -40 to 85 °C * Recommend soldering method : Reflow soldering

Maximum Allowable Voltage	Maximum DC Voltage that can be applied continuously within the operating temperature range
Varistor Voltage	Varistor starting voltage between terminals at DC 1 mA, also known as Breakdown voltage
Maximum Peak Current	Varistor's maximum current under the standard pulse 8/20μs, 2 times based
Maximum ESD	Varistor's maximum voltage under ESD based on IEC61000-4-2, 10 times (5 times of each positive-negative polarity)

Design and specifications are each subject to change without notice. Ask factory for the current technical specifications before purchase and/or use. Should a safety concern arise regarding this product, please be sure to contact us immediately.

■ Voltage vs. Current

● EZJP Series

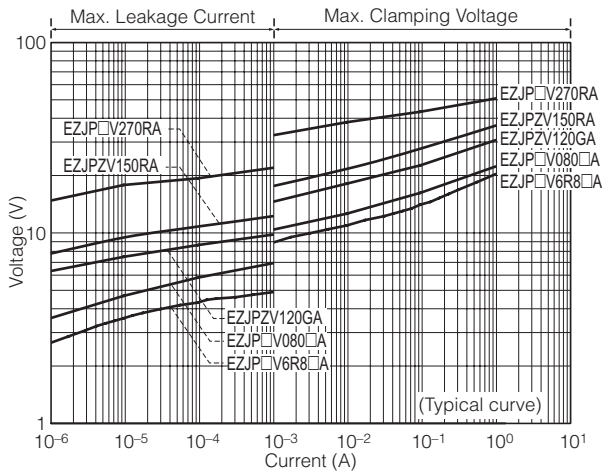

● EZJZ Series

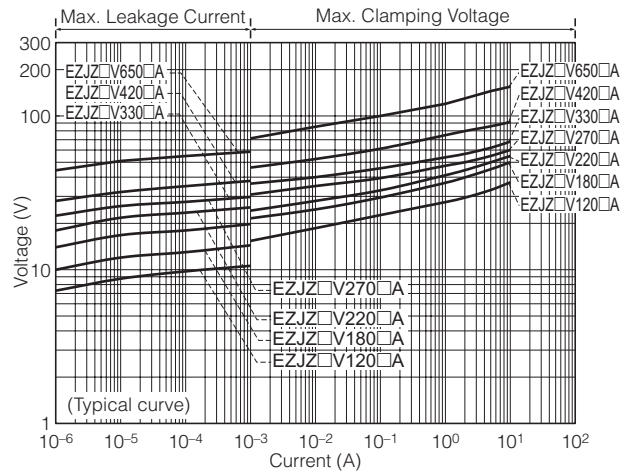

■ Frequency vs. Capacitance

● EZJP Series

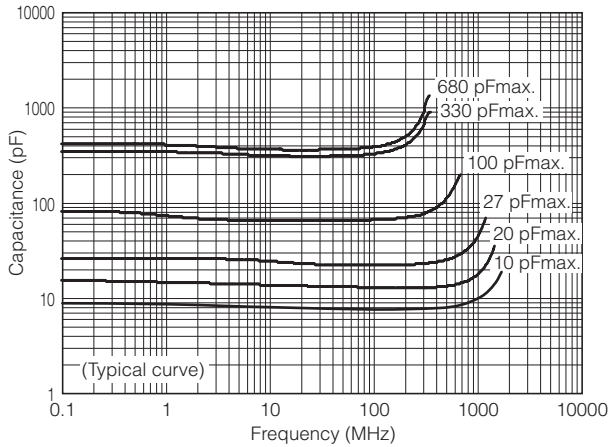

● EZJZ Series

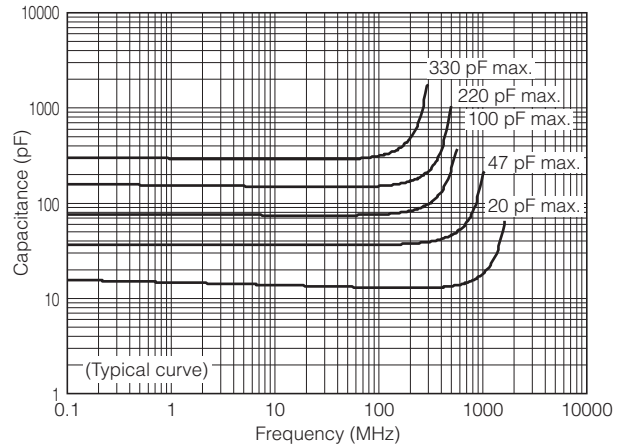

■ Frequency vs. Transmission

● EZJP Series

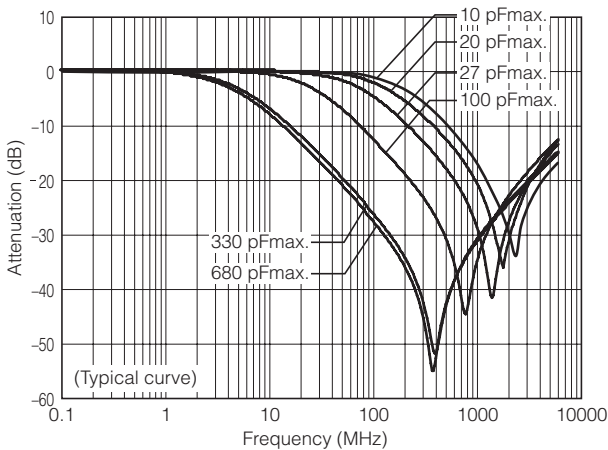

● EZJZ Series

