

阅读申明

- 1.本站收集的数据手册和产品资料都来自互联网，版权归原作者所有。如读者和版权方有任何异议请及时告之，我们将妥善解决。
- 2.本站提供的中文数据手册是英文数据手册的中文翻译，其目的是协助用户阅读，该译文无法自动跟随原稿更新，同时也可能存在翻译上的不当。建议读者以英文原稿为参考以便获得更精准的信息。
- 3.本站提供的产品资料，来自厂商的技术支持或者使用者的心得体会等，其内容可能存在描述上的差异，建议读者做出适当判断。
- 4.如需与我们联系，请发邮件到marketing@iczoom.com，主题请标有“数据手册”字样。

Read Statement

1. The datasheets and other product information on the site are all from network reference or other public materials, and the copyright belongs to the original author and original published source. If readers and copyright owners have any objections, please contact us and we will deal with it in a timely manner.
2. The Chinese datasheets provided on the website is a Chinese translation of the English datasheets. Its purpose is for reader's learning exchange only and do not involve commercial purposes. The translation cannot be automatically updated with the original manuscript, and there may also be improper translations. Readers are advised to use the English manuscript as a reference for more accurate information.
3. All product information provided on the website refer to solutions from manufacturers' technical support or users the contents may have differences in description, and readers are advised to take the original article as the standard.
4. If you have any questions, please contact us at marketing@iczoom.com and mark the subject with "Datasheets" .

PLL Synthesizer with I²C Bus for TV Tuner

DESCRIPTION

The NJW1504/1508 are a PLL frequency synthesizer especially designed for TV and VCR tuning systems and consists of PLL circuit and a prescaler which operates up to 1.0GHz, built into one chip.

The NJW1504/1508 are controlled through an I²C-bus.

FEATURES

- Operating Voltage 5V
- Low Operating Current : 15mA typ. @V_{cc}=5V
- Prescaler accepts frequencies up to 1GHz on chip
- Reference Signal :
 NJW1504: Reference Signal Oscillator with peripheral of Xtal on chip
 NJW1508: Buffer Amplifier for External Reference Signal on chip
- 34V max. tuning voltage output
- Package Outline: SSOP16

PACKAGE OUTLINE

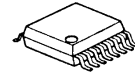

NJW1504V/NJW1508V

BLOCK DIAGRAM

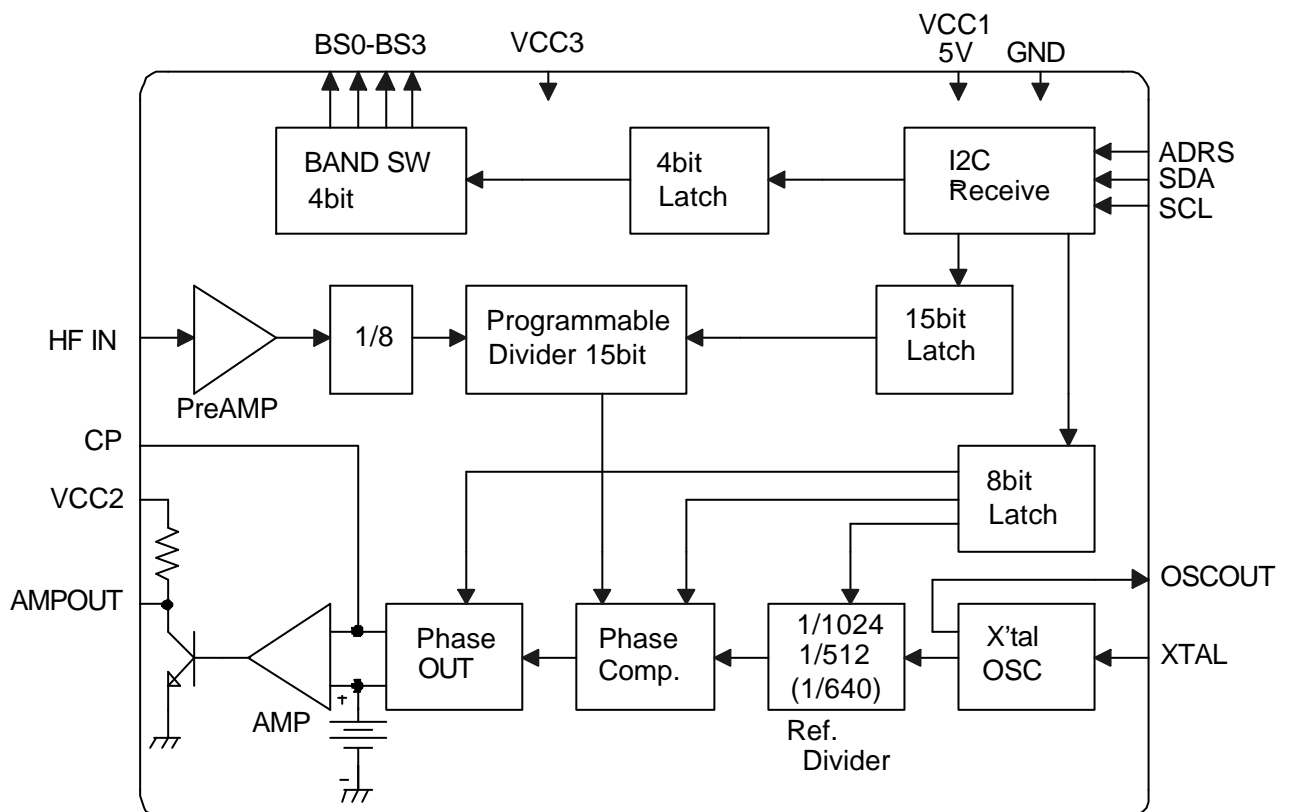

(Note)

Purchase of I²C components of New Japan Radio Co., Ltd or one of its sublicensed Associated Companies conveys a license under the Philips I²C Patent Rights to use these components in an I²C system, provided that the system conforms to the I²C standard specification as defined by Philips.

■ ABSOLUTE MAXIMUM RATINGS

(T_A=25°C)

Parameter	Symbol	Ratings	Unit
Supply Voltage (Vcc1, 3)	Vcc1, Vcc3	-0.3 to +6.5	V
Supply Voltage (Vcc2)	Vcc2	-0.3 to +36	V
Input Voltage (except I ² C bus)	V _i	-0.3 to Vcc+0.3	V
Output Voltage (except I ² C bus)	V _o	-0.3 to Vcc+0.3	V
I ² C bus Input Voltage	V _{iiic}	-0.3 to 6.5	V
Power Dissipation	P _D	300	mW
Operating Temperature Range	T _{opr}	-20 to +85	°C
Storage Temperature Range	T _{stg}	-40 to +125	°C

■ RECOMMENDED OPERATING CONDITION

(T_A=25°C)

Parameter	Condition	Symbol	Min.	Typ.	Max.	Unit
Operating Voltage	Vcc1, Vcc3	Vcc1, Vcc3	4.5	5	5.5	V
Operating Voltage	Vcc2	Vcc2	0	-	34	V
X'tal Operating Range		f _{xial}	3.15	4	4.05	MHz
HF Input Frequency	Input= -20dBm	f _{hf}	80	-	1000	MHz
Clock Frequency		f _{SCL}	0	-	100	KHz
Bus Free Time		t _{BUF}	4.7	-	-	µs
Data Hold Time		t _{HDSTA}	2	-	-	µs
SCL Low Hold Time		t _{LOW}	4.7	-	-	µs
SCL High Hold Time		t _{HIGH}	2	-	-	µs
Set-up Time	Refer to I ² C bus Timing Chart	t _{SUSTA}	2	-	-	µs
Data Hold Time		t _{HDDAT}	0	-	-	µs
Data Set-up Time		t _{SUDAT}	250	-	-	nS
Rise Time		t _R	-	-	1000	nS
Fall Time		t _F	-	-	300	nS
Data Set-up Time		t _{SUSTO}	4	-	-	µs

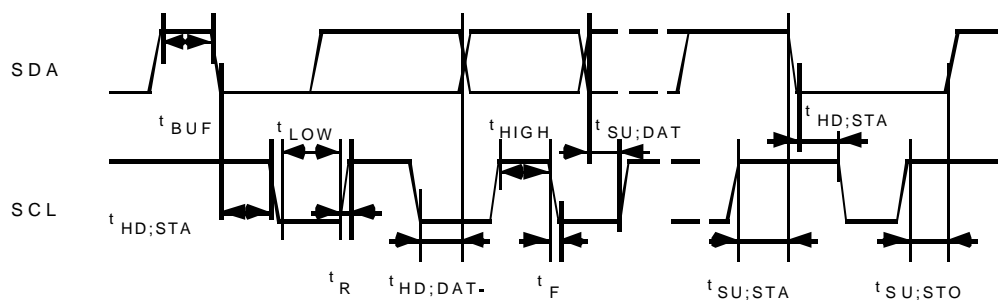

I²C bus Timing Chart

V_{IH}min(0.7 Vcc1) and V_{IL}max(0.3 Vcc1)

■ ELECTRICAL CHARACTERISTICS

(V_{cc1,3}=5V, V_{cc2}=34V, T_A=25°C)

Parameter	Condition	Symbol	Min.	Typ.	Max.	Unit
Operating Current 1	f _{HF} =100MHz	I _{CC}	12	15	21	mA
Operating Current 2	AMPOUT: Low Level	I _{CC2}	-	1.6	-	mA
AMP Input Current	Phase OUT: High Imp (2.5V)	I _{IN}	(-50)	0.1	(50)	nA
AMP Output Current	ANP OUT: Low Level AMPOUT Input=5V	I _{OUT}	-	-	-2	mA
AMP Gain	f=1KHz	AV	40	50	60	dB
Phase Comparator Output Current	Current Source	I _{source}	190	280	400	uA
Phase Comparator Output Current	Current Sink	I _{sink}	-400	-280	-190	uA
Band Switch						
"L" Output Current	BS0=BS1=0.3V	I _{OBS0-1L}	-2.0	-1	0	mA
"H" Output Current	BS0=BS1=4.7V	I _{OBS0-1H}	11.0	15.0	-	mA
"L" Output Current	BS2=BS3=0.3V	I _{OBS2-3L}	-2.0	-1.0	0	mA
"H" Output Current	BS2=BS3=4.7V	I _{OBS2-3H}	5.5	7.5	-	mA
I ² C bus						
"H" Input Current	SCL, SDA Terminal	I _{INH}	-5	0	5	uA
"L" Input Current	SCL, SDA Terminal	I _{INL}	-5	0	5	uA
"H" Input Voltage Range	SCL, SDA Terminal	V _{IH}	3.5	-	5.3	V
"L" Input Voltage Range	SCL, SDA Terminal	V _{IL}	0	-	1.5	V
ACK Sink Current	ACK Output, SDA=0.4V	V _{ACK}	3	-	-	mA

NJW1504/1508

■ TEST CIRCUIT

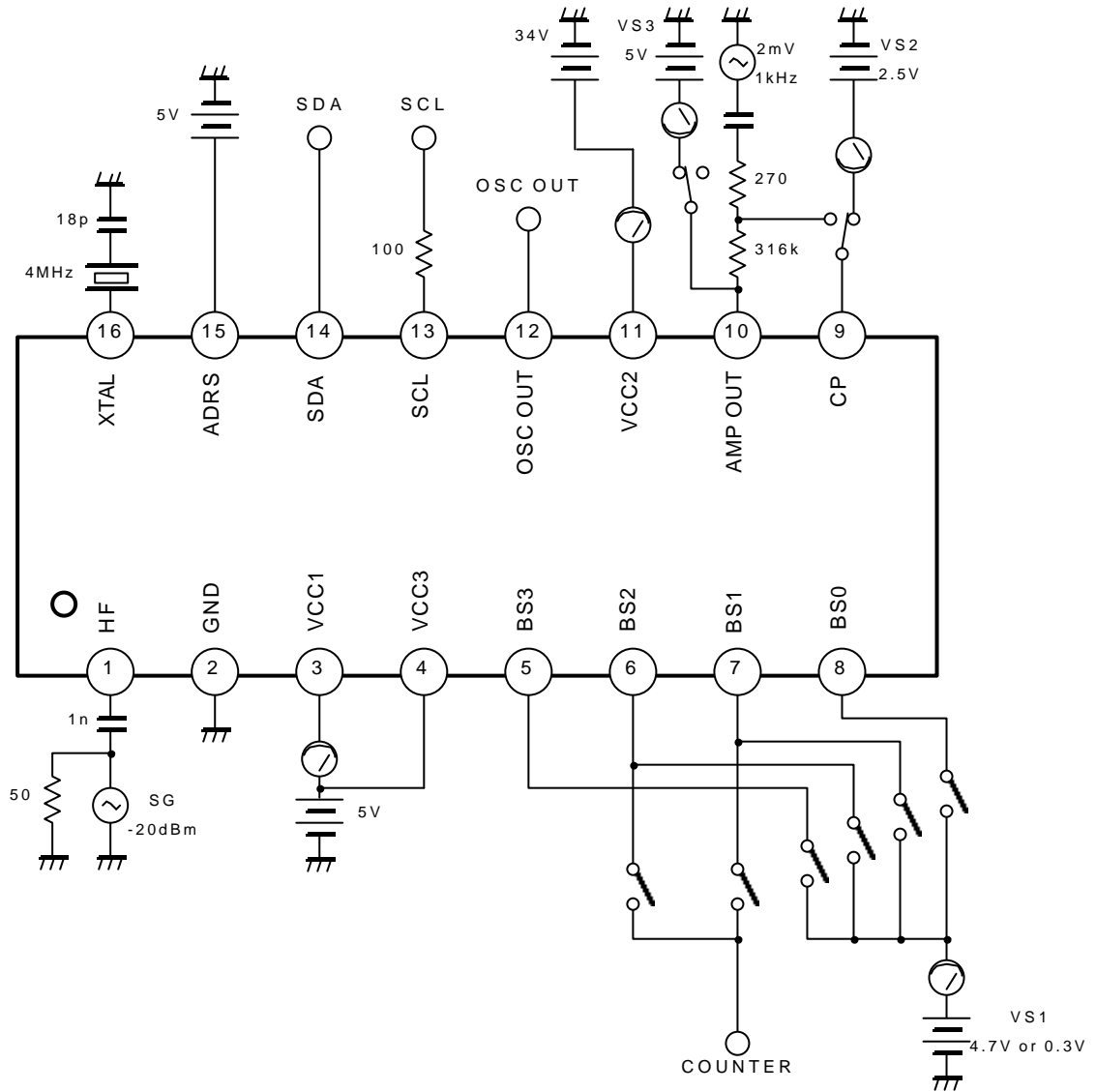

■ I²C bus Protocols

The input information, which consists of chip address and next two or four byte data, is received by I²C bus receiver. The allowable I²C bus protocols are as follows.

- (1) STA CA CB BB STO
- (2) STA CA D1 D2 STO
- (3) STA CA CB BB D1 D2 STO
- (4) STA CA D1 D2 CB BB STO

STA: Start Condition

STO: Stop Condition

CA: Chip Address

CB: Control Byte

BB: Band switch Byte

D1: Divider Byte 1

D2: Divider Byte 2

For suitable circuit operation, 5-byte data should have chip address, 2-byte control data, band data, and 2-byte divider byte. Following chip address, 2-byte data is received. For distinction of each data, first and third data byte has a function bit. As function bit, divider byte has "1" and control/band data has "0".

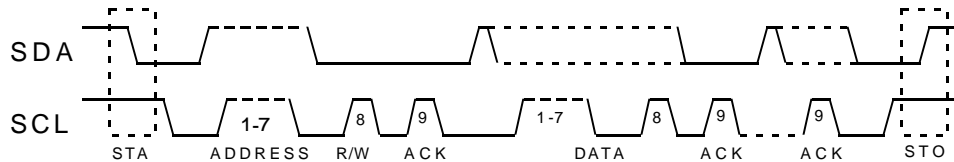

NJW1504/1508

■ Data Format

Parameter	Symbol	MSB								LSB
Chip Address	CA	1	1	0	0	0	CA1	CA0	0	A
Divider Byte 1	D1	0	N14	N13	N12	N11	N10	N9	N8	A
Divider Byte 2	D2	N7	N6	N5	N4	N3	N2	N1	N0	A
Control Byte	CB	1	CP	T2	T1	T0	RD1	RD0	x	A
Band switch Byte	BB	x	x	x	x	BS3	BS2	BS1	BS0	A

· Data specifications

x : don't care ;0 or 1

CA1, CA0 : Programmable address bits

ADRS Voltage	CA1	CA0
Always valid	0	1
0 to 0.1 Vcc1	0	0
0.4 Vcc1 to 0.6 Vcc1	1	0
0.9 Vcc1 to Vcc1	1	1

BS0 to BS3 : Band switch buffers Control bits, BS_n=1 then "ON"

N0 to N14 : Control of Programmable divider bits, N14=MSB N0=LSB

Dividing ratio : $N=2^{14} \times N14 + 2^{13} \times N13 + \dots + 2^1 \times N1 + N0$

Maximum division ratio 32767

Minimum division ratio 256

CP : Charge Pump Current

CP	Charge Pump Current	Conditions
1	280μA	Normal, Default
0	60μA	Test

T0 to T2 : Test mode bits

T0, T1, T2 : Phase Comparator Output bits

T2	T1	T0	Phase Comparator, Band Switch	Conditions
0	0	x	Normal Output	Normal, Default
1	0	1	Phase Comparator (High Impedance)	Test
1	1	0	Phase Comparator (Sink)	Test
1	1	1	Phase Comparator (Source)	Test

RD1, RD0 : Reference Divider bits

RD1	RD2	Reference Divider	Conditions
x	0	640	
1	1	512	Default
0	1	1024	

(Note)

Default : Power on reset

■ TERMINAL CHARACTERISTICS

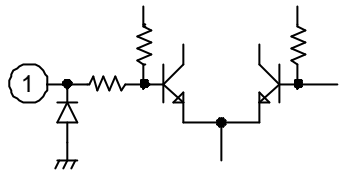
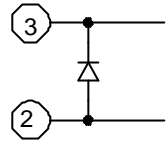
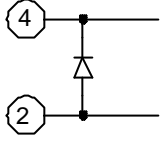
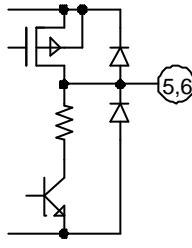
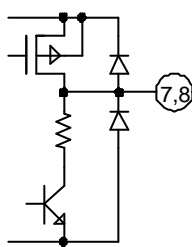
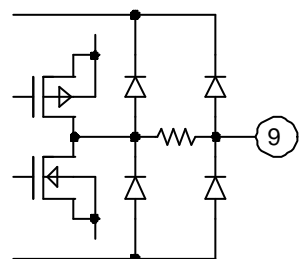
No.	Symbol	Typ.DC Voltage (V)	Equivalent Circuit	Function
1	HF	3.2		High Frequency Signal Input
2	GND	0		GND
3	VCC1	5		Power Supply
4	VCC3	5		Band Switch Power Supply
5 6	BS3 BS2	0		Band Switch (Typ: 7.5mA)
7 8	BS1 BS0	0		Band Switch (Typ: 15mA)
9	CP	-		Charge Pump Output

No.	Symbol	Typ.DC Voltage (V)	Equivalent Circuit	Function
10	AMPOUT	-		Amplifier Output
11	VCC2	34		Amplifier Power Supply
12	OSCOUT	4.1		Reference Oscillator Output
13	SCL	-		SCL Input (I ² C bus)
14	SDA	-		SCL Input (I ² C bus)
15	ADRS	-		ADRS Input (I ² C bus)
16	XTAL	3.3		Crystal Input

■ TYPICAL CHARACTERISTICS

$T_A=25^\circ\text{C}$

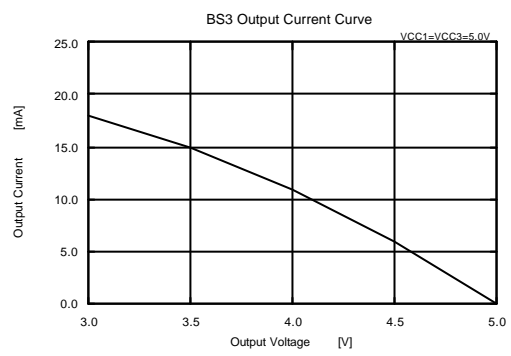
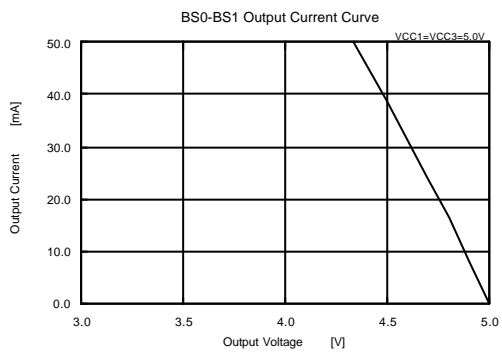
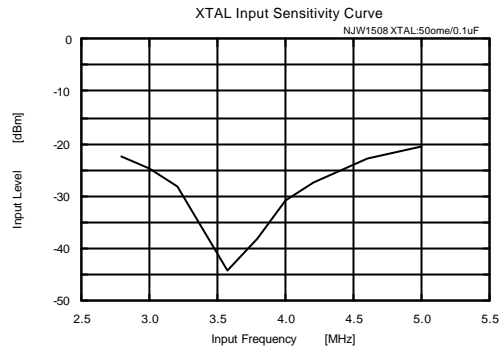
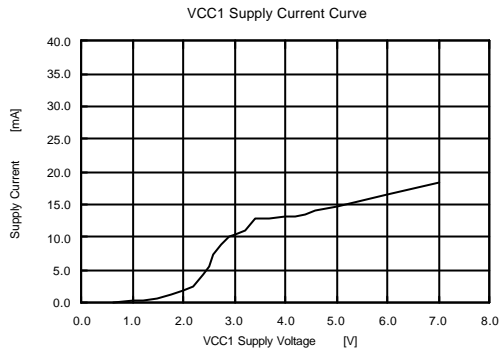

MEMO

[CAUTION]

The specifications on this databook are only given for information, without any guarantee as regards either mistakes or omissions. The application circuits in this databook are described only to show representative usages of the product and not intended for the guarantee or permission of any right including the industrial rights.