

## 阅读申明

- 1.本站收集的数据手册和产品资料都来自互联网，版权归原作者所有。如读者和版权方有任何异议请及时告之，我们将妥善解决。
- 2.本站提供的中文数据手册是英文数据手册的中文翻译，其目的是协助用户阅读，该译文无法自动跟随原稿更新，同时也可能存在翻译上的不当。建议读者以英文原稿为参考以便获得更精准的信息。
- 3.本站提供的产品资料，来自厂商的技术支持或者使用者的心得体会等，其内容可能存在描述上的差异，建议读者做出适当判断。
- 4.如需与我们联系，请发邮件到marketing@iczoom.com，主题请标有“数据手册”字样。

## Read Statement

1. The datasheets and other product information on the site are all from network reference or other public materials, and the copyright belongs to the original author and original published source. If readers and copyright owners have any objections, please contact us and we will deal with it in a timely manner.
2. The Chinese datasheets provided on the website is a Chinese translation of the English datasheets. Its purpose is for reader's learning exchange only and do not involve commercial purposes. The translation cannot be automatically updated with the original manuscript, and there may also be improper translations. Readers are advised to use the English manuscript as a reference for more accurate information.
3. All product information provided on the website refer to solutions from manufacturers' technical support or users the contents may have differences in description, and readers are advised to take the original article as the standard.
4. If you have any questions, please contact us at marketing@iczoom.com and mark the subject with "Datasheets" .

## GTL6C816A GTLP/LVTTL 1:6 Clock Driver

### General Description

The GTLP6C816A is a clock driver that provides LVTTL to GTLP signal level translation (and vice versa). The device provides a high speed interface between cards operating at LVTTL logic levels and a backplane operating at GTLP(P) logic levels. High speed backplane operation is a direct result of GTLP's reduced output swing (<1V), reduced input threshold levels and output edge rate control. The edge rate control minimizes bus settling time. GTLP is a Fairchild Semiconductor derivative of the Gunning Transceiver logic (GTL) JEDEC standard JESD8-3.

Fairchild's GTLP(P) has internal edge-rate control and is process, voltage, and temperature (PVT) compensated. Its function is similar to BTL and GTL but with different output levels and receiver threshold. GTLP output LOW level is typically less than 0.5V, the output level HIGH is 1.5V and the receiver threshold is 1.0V.

### Features

- Interface between LVTTL and GTLP logic levels
- Designed with edge rate control circuitry to reduce output noise on the GTLP port
- $V_{REF}$  pin provides external supply reference voltage for receiver threshold adjustability
- Special PVT compensation circuitry to provide consistent performance over variations of process, supply voltage and temperature
- TTL compatible driver and control inputs
- Designed using Fairchild advanced BiCMOS technology
- Bushold data inputs on A port to eliminate the need for external pull-up resistors for unused inputs
- Power up/down and power off high impedance for live insertion
- Open drain on GTLP to support wired-or connection
- A Port source/sink -24mA/+24mA
- B Port sink +50mA
- 1:6 fanout clock driver for TTL port
- 1:2 fanout clock driver for GTLP port
- Low voltage version of GTLP6C816

### Ordering Code:

Order Number	Package Number	Package Description
GTL6C816AMTC	MTC24	24-Lead Thin Shrink Small Outline Package (TSSOP), JEDEC MO-153, 4.4mm Wide

Device is also available in Tape and Reel. Specify by appending the suffix letter "X" to the ordering code.

### Pin Descriptions

Pin Names	Description
TTLIN, GTLPIN	Clock Inputs (LVTTL and GTLP respectively)
$\overline{OE}B$	Output Enable (Active LOW) GTLP Port (LVTTL Levels)
$\overline{OE}A$	Output Enable (Active LOW) TTL Port (LVTTL Levels)
$V_{CCT}$ -GNDT	TTL Output Supplies
$V_{CC}$	Internal Circuitry $V_{CC}$
GNDG	OBn GTLP Output Grounds
$V_{REF}$	Voltage Reference Input
OA0-OA5	TTL Buffered Clock Outputs
OB0-OB1	GTLP Buffered Clock Outputs

### Connection Diagram

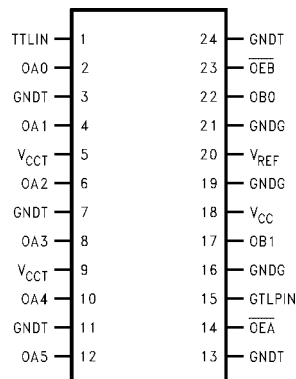

## Functional Description

The GTLP6C816A is a clock driver providing LVTTTL-to-GTLP clock translation, and GTLP-to-LVTTTL clock translation in the same package. The LVTTTL-to-GTLP direction is a 1:2 clock driver path with a single Enable pin ( $\overline{OEB}$ ). For the GTLP-to-LVTTTL direction the clock receiver path is a 1:6 buffer with a single Enable control ( $\overline{OEA}$ ). Data polarity is inverting for both directions.

## Truth Tables

Inputs		Outputs
TTLIN	$\overline{OEB}$	OBn
H	L	L
L	L	H
X	H	High Z

Inputs		Outputs
GTLPIN	$\overline{OEA}$	OAn
H	L	L
L	L	H
X	H	High Z

## Logic Diagram

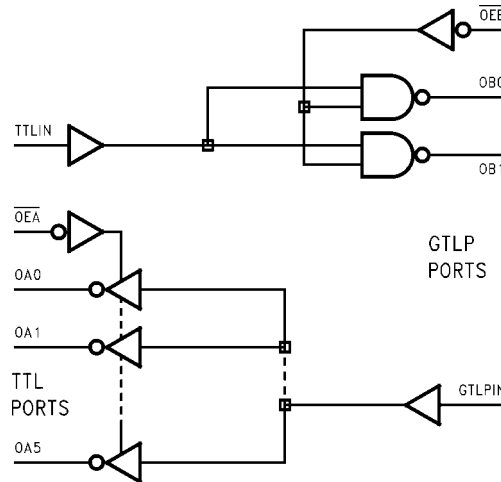

### Absolute Maximum Ratings (Note 1)

Supply Voltage ( $V_{CC}$ )	-0.5V to +4.6V
DC Input Voltage ( $V_I$ )	-0.5V to +4.6V
DC Output Voltage ( $V_O$ )	
Outputs 3-STATE	-0.5V to +4.6V
Outputs Active (Note 2)	-0.5V to +4.6V
DC Output Sink Current into OA Port $I_{OL}$	48 mA
DC Output Source Current from OA Port $I_{OH}$	-48 mA
DC Output Sink Current into OB Port in the LOW State $I_{OL}$	100 mA
DC Input Diode Current ( $I_{IK}$ ) $V_I < 0V$	-50 mA
DC Output Diode Current ( $I_{OK}$ ) $V_O < 0V$	-50 mA
$V_O > V_{CC}$	+50 mA
ESD Rating	> 2000V
Storage Temperature ( $T_{STG}$ )	-65°C to +150°C

### Recommended Operating Conditions (Note 3)

Supply Voltage $V_{CC}$	3.15V to 3.45V
Bus Termination Voltage ( $V_{TT}$ )	
GTLP	1.47V to 1.53V
GTL	1.14V to 1.26V
$V_{REF}$	0.98V to 1.02V
Input Voltage ( $V_I$ ) on INA-Port and Control Pins	0.0V to 3.45V
HIGH Level Output Current ( $I_{OH}$ ) OA Port	-24 mA
LOW Level Output Current ( $I_{OL}$ ) OA Port	+24 mA
OB Port	+50 mA
Operating Temperature ( $T_A$ )	-40°C to +85°C

**Note 1:** Absolute Maximum continuous ratings are those values beyond which damage to the device may occur. Exposure to these conditions or conditions beyond those indicated may adversely affect device reliability. Functional operation under absolute maximum rated conditions is not implied.

**Note 2:**  $I_o$  Absolute Maximum Rating must be observed.

**Note 3:** Unused inputs must be held HIGH or LOW.

### DC Electrical Characteristics

Over Recommended Operating Free-Air Temperature Range,  $V_{REF} = 1.0V$  (unless otherwise noted).

Symbol		Test Conditions		Min	Typ (Note 4)	Max	Units
$V_{IH}$	GTLPIN			$V_{REF} + 0.05$		$V_{TT}$	V
	Others			2.0			V
$V_{IL}$	GTLPIN			0.0		$V_{REF} - 0.05$	V
	Others					0.8	V
$V_{REF}$ (Note 5)	GTLP				1.0		V
$V_{TT}$ (Note 5)	GTLP				1.5		V
$V_{IK}$		$V_{CC} = 3.15V$	$I_I = -18 \text{ mA}$			-1.2	V
$V_{OH}$	OAn Port	$V_{CC} = 3.15V$	$I_{OH} = -100 \mu A$	$V_{CC} - 0.2$			V
			$I_{OH} = -18 \text{ mA}$	2.4			
			$I_{OH} = -24 \text{ mA}$	2.2			
$V_{OL}$	OAn Port	$V_{CC} = 3.15V$	$I_{OL} = 100 \mu A$			0.2	V
			$I_{OL} = 18 \text{ mA}$			0.4	
			$I_{OL} = 24 \text{ mA}$			0.5	
$V_{OL}$	OBn Port	$V_{CC} = 3.15V$	$I_{OL} = 100 \mu A$			0.2	V
			$I_{OL} = 40 \text{ mA}$			0.4	
			$I_{OL} = 50 \text{ mA}$			0.55	
$I_I$	TTLIN/ Control Pins	$V_{CC} = 3.45V$	$V_I = 3.45V$ $V_I = 0V$			5 -5	$\mu A$
	GTLPIN	$V_{CC} = 3.45V$	$V_I = V_{TT}$ $V_I = 0$			5 -5	$\mu A$
$I_{OFF}$	TTLIN	$V_{CC} = 0$	$V_I$ or $V_O = 0V$ to 3.45V			30	$\mu A$
	GTLPIN	$V_{CC} = 0$	$V_I$ or $V_O = 0V$ to $V_{TT}$			30	$\mu A$
$I_{PU/PD}$	OAn or OBn Ports	$V_{CC} = 0$ to 1.5V	$\overline{OE} = \text{Don't Care}$			30	$\mu A$
$I_{OZH}$	OAn-Port	$V_{CC} = 3.45V$	$V_O = 3.45V$			5	$\mu A$
	OBn-Port		$V_O = 1.5V$			5	
$I_{OZL}$	OAn-Port	$V_{CC} = 3.45V$	$V_O = 0$			-5	$\mu A$
$I_{CC}$	OAn or OBn Ports	$V_{CC} = 3.45V$	Outputs HIGH		5.5	10	mA
			Outputs LOW		5	10	
		$V_I = V_{CC}$ or GND	Outputs Disabled		5.5	10	

## DC Electrical Characteristics (Continued)

Symbol	Test Conditions	Min	Typ (Note 4)	Max	Units
$\Delta I_{CC}$	TTLIN	$V_{CC} = 3.45V$	$V_I = V_{CC} - 0.6$	2	mA
$C_I$	Control Pins/GTLPIN/TTLIN		$V_I = V_{CC}$ or 0	4.5	pF
$C_O$	OAn Port		$V_I = V_{CC}$ or 0	6.0	
	OBn Port		$V_I = V_{CC}$ or 0	8.0	

**Note 4:** All typical values are at  $V_{CC} = 3.3V$  and  $T_A = 25^\circ C$ .

**Note 5:** GTLP  $V_{REF}$  and  $V_{TT}$  are specified to 2% tolerance since signal integrity and noise margin can be significantly degraded if these supplies are noisy. In addition,  $V_{TT}$  and  $R_{TERM}$  can be adjusted to accommodate backplane impedances other than  $50\Omega$ , within the boundaries of not exceeding the DC Absolute  $I_{OL}$  ratings. Similarly  $V_{REF}$  can be adjusted to compensate for changes in  $V_{TT}$ .

## AC Electrical Characteristics

Over recommended range of supply voltage and operating free air temperature.  $V_{REF} = 1.0V$  (unless otherwise noted).  
 $C_L = 30$  pF for OBn-Port and  $C_L = 50$  pF for OAn-Port.

Symbol	From (Input)	To (Output)	Min	Typ (Note 6)	Max	Units
$f_{TOGGLE}$	TTLIN	OBn	175			MHz
	GTLPIN	OAn	175			
$t_{PLH}$	TTLIN	OBn	1.3	2.3	4.0	ns
$t_{PHL}$			0.9	2.6	4.3	
$t_{PLH}$	$\overline{OEB}$	OBn	1.5	2.6	4.1	ns
$t_{PHL}$			1.2	2.5	4.1	
$t_{RISE}$	Transition Time, OB Outputs (20% to 80%)			1.3		ns
$t_{FALL}$	Transition Time, OB outputs (20% to 80%)			1.3		
$t_{RISE}$	Transition Time, OA outputs (10% to 90%)			1.2		ns
$t_{FALL}$	Transition Time, OA outputs (10% to 90%)			2.0		
$t_{PZH}, t_{PZL}$	$\overline{OEA}$	OAn	0.5	2.9	4.8	ns
$t_{PLZ}, t_{PHZ}$			0.5	2.4	4.4	
$t_{PLH}$	GTLPIN	OAn	1.9	3.6	5.7	ns
$t_{PHL}$			2.1	3.5	5.3	

**Note 6:** All typical values are at  $V_{CC} = 3.3V$  and  $T_A = 25^\circ C$ .

## Extended Electrical Characteristics

Over recommended ranges of supply voltage and operating free-air temperature  $V_{REF} = 1.0V$  (unless otherwise noted).  
 $C_L = 30$  pF for B Port and  $C_L = 50$  pF for A Port

Symbol	From (Input)	To (Output)	Min	Typ (Note 7)	Max	Units
$t_{OSLH}$ (Note 8)	A	B		0.1	0.2	ns
$t_{OSHL}$ (Note 8)	A	B		0.1	0.6	ns
$t_{PS}$ (Note 9)	A	B		0.3	1.0	ns
$t_{PV(HL)}$ (Note 10)(Note 11)	A	B			1.3	ns
$t_{OSLH}$ (Note 8)	B	A		0.1	0.7	ns
$t_{OSHL}$ (Note 8)	B	A		0.1	0.4	ns
$t_{OST}$ (Note 8)	B	A		0.2	1.1	ns
$t_{PS}$ (Note 9)	B	A		0.1	1.0	ns
$t_{PV}$ (Note 10)	B	A			2.4	ns

**Note 7:** All typical values are at  $V_{CC} = 3.3$  V and  $T_A = 25^\circ\text{C}$ .

**Note 8:**  $t_{OSHL}/t_{OSLH}$  and  $t_{OST}$  – Output-to-Output skew is defined as the absolute value of the difference between the actual propagation delay for all outputs within the same packaged device. The specifications are given for specific worst case  $V_{CC}$  and temperature and apply to any outputs switching in the same direction either HIGH-to-LOW ( $t_{OSHL}$ ) or LOW-to-HIGH ( $t_{OSLH}$ ) or in opposite directions both HL and LH ( $t_{OST}$ ). This parameter is guaranteed by design and statistical process distribution. Actual skew values between the GTLP outputs could vary on the backplane due to the loading and impedance seen by the device.

**Note 9:**  $t_{PS}$  – Pin or Transition skew is defined as the difference between the LOW-to-HIGH transition and the HIGH-to-LOW transition on the same pin. The parameter is measured across all the outputs of the same chip is specified for a specific worst case  $V_{CC}$  and temperature. This parameter is guaranteed by design and statistical process distribution. Actual skew values between the GTLP outputs could vary on the backplane due to the loading and impedance seen by the device.

**Note 10:**  $t_{PV}$  – Part-to-Part skew is defined as the absolute value of the difference between the actual propagation delay for all outputs from device-to-device. The parameter is specified for a specific worst case  $V_{CC}$  and temperature. This parameter is guaranteed by design and statistical process distribution. Actual skew values between the GTLP output could vary on the backplane due to the loading and impedance seen by the device.

**Note 11:** Due to the open drain structure on GTLP outputs  $t_{OST}$  and  $t_{PV(LH)}$  in the A-to-B direction are not specified. Skew on these paths is dependent on the  $V_{TT}$  and  $R_T$  values on the backplane.

## Test Circuit and Timing Waveforms

**Test Circuit for A Outputs**

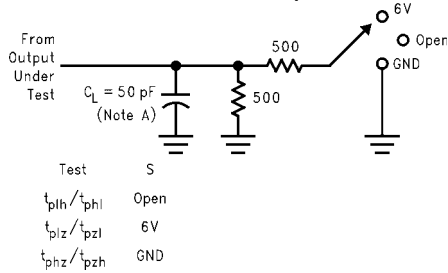

**Note A:**  $C_L$  includes probes and jig capacitance.

**Test Circuit for B Outputs**

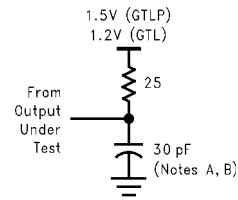

**Note A:**  $C_L$  includes probes and jig capacitance.

**Note B:** For B Port  $C_L = 30 \text{ pF}$  is used for worst case.

**Voltage Waveform - Propagation Delay Times**

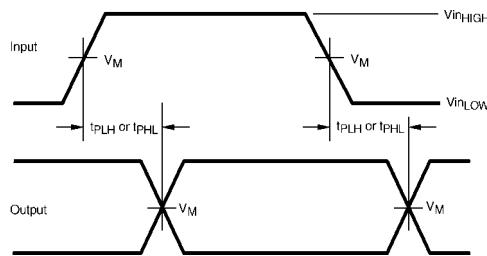

**Voltage Waveform - Enable and Disable Times**

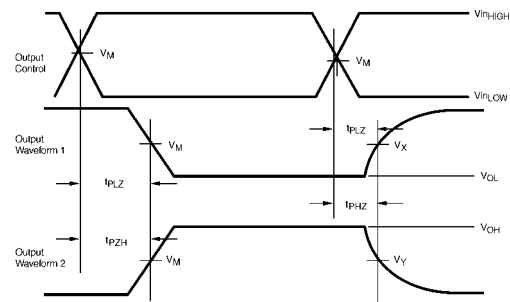

Output Waveform 1 is for an output with internal conditions such that the output is LOW except when disabled by the control output  
Output Waveform 2 is for an output with internal conditions such that the output is HIGH except when disabled by the control output

**Input and Measure Conditions**

	A or LVTTTL Pins	B or GTLP Pins
$V_{inHIGH}$	3.0	1.5
$V_{inLOW}$	0.0	0.0
$V_M$	1.5	1.0
$V_X$	$V_{OL} + 0.3V$	N/A
$V_Y$	$V_{OH} + 0.3V$	N/A

All input pulses have the following characteristics: Frequency = 10MHz,  $t_{RISE} = t_{FALL} = 2 \text{ ns}$ ,  $Z_O = 50\Omega$ .  
The outputs are measured one at a time with one transition per measurement.

**Physical Dimensions** inches (millimeters) unless otherwise noted

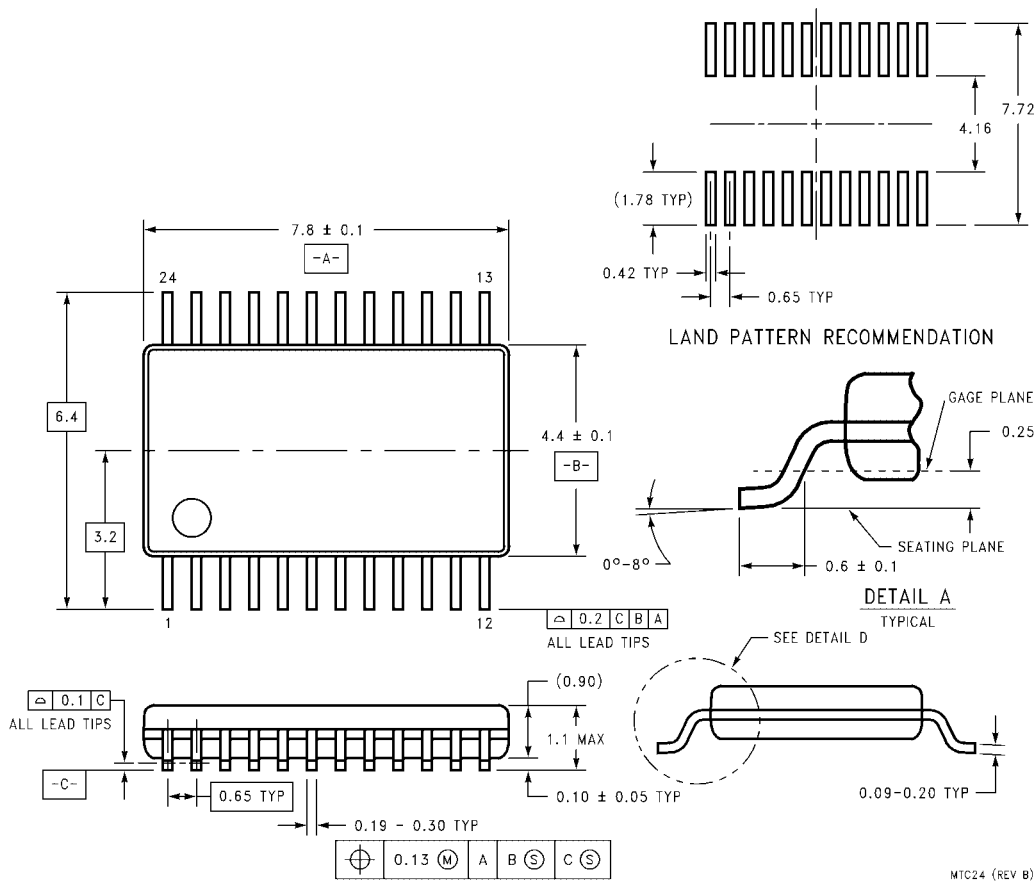

**24-Lead Thin Shrink Small Outline Package (TSSOP), JEDEC MO-153, 4.4mm Wide  
Package Number MTC24**

Fairchild does not assume any responsibility for use of any circuitry described, no circuit patent licenses are implied and Fairchild reserves the right at any time without notice to change said circuitry and specifications.

**LIFE SUPPORT POLICY**

FAIRCHILD'S PRODUCTS ARE NOT AUTHORIZED FOR USE AS CRITICAL COMPONENTS IN LIFE SUPPORT DEVICES OR SYSTEMS WITHOUT THE EXPRESS WRITTEN APPROVAL OF THE PRESIDENT OF FAIRCHILD SEMICONDUCTOR CORPORATION. As used herein:

1. Life support devices or systems are devices or systems which, (a) are intended for surgical implant into the body, or (b) support or sustain life, and (c) whose failure to perform when properly used in accordance with instructions for use provided in the labeling, can be reasonably expected to result in a significant injury to the user.
2. A critical component in any component of a life support device or system whose failure to perform can be reasonably expected to cause the failure of the life support device or system, or to affect its safety or effectiveness.

[www.fairchildsemi.com](http://www.fairchildsemi.com)