

阅读申明

- 1.本站收集的数据手册和产品资料都来自互联网，版权归原作者所有。如读者和版权方有任何异议请及时告之，我们将妥善解决。
- 2.本站提供的中文数据手册是英文数据手册的中文翻译，其目的是协助用户阅读，该译文无法自动跟随原稿更新，同时也可能存在翻译上的不当。建议读者以英文原稿为参考以便获得更精准的信息。
- 3.本站提供的产品资料，来自厂商的技术支持或者使用者的心得体会等，其内容可能存在描述上的差异，建议读者做出适当判断。
- 4.如需与我们联系，请发邮件到marketing@iczoom.com，主题请标有“数据手册”字样。

Read Statement

1. The datasheets and other product information on the site are all from network reference or other public materials, and the copyright belongs to the original author and original published source. If readers and copyright owners have any objections, please contact us and we will deal with it in a timely manner.
2. The Chinese datasheets provided on the website is a Chinese translation of the English datasheets. Its purpose is for reader's learning exchange only and do not involve commercial purposes. The translation cannot be automatically updated with the original manuscript, and there may also be improper translations. Readers are advised to use the English manuscript as a reference for more accurate information.
3. All product information provided on the website refer to solutions from manufacturers' technical support or users the contents may have differences in description, and readers are advised to take the original article as the standard.
4. If you have any questions, please contact us at marketing@iczoom.com and mark the subject with "Datasheets" .

Low-Cost 3.3V Zero Delay Buffer

Features

- 10 MHz to 100-/133 MHz operating range, compatible with CPU and PCI bus frequencies
- Zero input-output propagation delay
- 60 ps typical cycle-to-cycle jitter (high drive)
- Multiple low-skew outputs
 - 85 ps typical output-to-output skew
 - One input drives five outputs (CY2305)
 - One input drives nine outputs, grouped as 4 + 4 + 1 (CY2309)
- Compatible with Pentium-based systems
- Test Mode to bypass phase-locked loop (PLL) (CY2309 only [see "Select Input Decoding" on page 3])
- Available in space-saving 16-pin 150-mil SOIC or 4.4-mm TSSOP packages (CY2309), and 8-pin, 150-mil SOIC package (CY2305)
- 3.3V operation
- Industrial temperature available

Functional Description

The CY2309 is a low-cost 3.3V zero delay buffer designed to distribute high-speed clocks and is available in a 16-pin SOIC or TSSOP package. The CY2305 is an 8-pin version of the CY2309. It accepts one reference input, and drives out five low-skew clocks. The -1H versions of each device operate at up to 100-/133 MHz frequencies, and have higher drive than the -1 devices. All parts have on-chip PLLs which lock to an input clock on the REF pin. The PLL feedback is on-chip and is obtained from the CLKOUT pad.

The CY2309 has two banks of four outputs each, which can be controlled by the Select inputs as shown in the "Select Input Decoding" table on page 3. If all output clocks are not required, BankB can be three-stated. The select inputs also allow the input clock to be directly applied to the outputs for chip and system testing purposes.

The CY2305 and CY2309 PLLs enter a power down mode when there are no rising edges on the REF input. In this state, the outputs are three-stated and the PLL is turned off, resulting in less than 25.0 μ A current draw for these parts. The CY2309 PLL shuts down in one additional case as shown in the table below.

Multiple CY2305 and CY2309 devices can accept the same input clock and distribute it. In this case, the skew between the outputs of two devices is guaranteed to be less than 700 ps.

The CY2305/CY2309 is available in two/three different configurations, as shown in the ordering information (page 10). The CY2305-1/CY2309-1 is the base part. The CY2305-1H/CY2309-1H is the high-drive version of the -1, and its rise and fall times are much faster than the -1s.

Logic Block Diagram

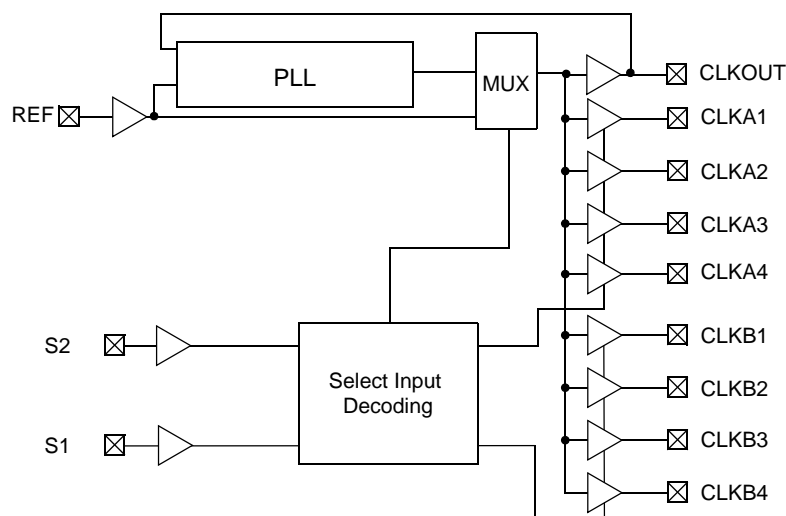

Pinouts

Figure 1. Pin Diagram - CY2305

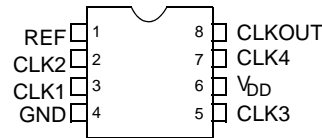

Table 1. Pin Description for CY2305

Pin	Signal	Description
1	REF ^[1]	Input reference frequency, 5V-tolerant input
2	CLK2 ^[2]	Buffered clock output
3	CLK1 ^[2]	Buffered clock output
4	GND	Ground
5	CLK3 ^[2]	Buffered clock output
6	V _{DD}	3.3V supply
7	CLK4 ^[2]	Buffered clock output
8	CLKOUT ^[2]	Buffered clock output, internal feedback on this pin

Figure 2. Pin Diagram - CY2309

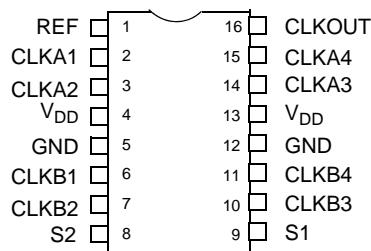

Table 2. Pin Description for CY2309

Pin	Signal	Description
1	REF ^[1]	Input reference frequency, 5V-tolerant input
2	CLKA1 ^[2]	Buffered clock output, Bank A
3	CLKA2 ^[2]	Buffered clock output, Bank A
4	V _{DD}	3.3V supply
5	GND	Ground
6	CLKB1 ^[2]	Buffered clock output, Bank B
7	CLKB2 ^[2]	Buffered clock output, Bank B
8	S2 ^[3]	Select input, bit 2
9	S1 ^[3]	Select input, bit 1
10	CLKB3 ^[2]	Buffered clock output, Bank B
11	CLKB4 ^[2]	Buffered clock output, Bank B
12	GND	Ground

Notes

1. Weak pull down.
2. Weak pull down on all outputs.
3. Weak pull ups on these inputs.

Table 2. Pin Description for CY2309

Pin	Signal	Description
13	V _{DD}	3.3V supply
14	CLKA3 ^[2]	Buffered clock output, Bank A
15	CLKA4 ^[2]	Buffered clock output, Bank A
16	CLKOUT ^[2]	Buffered output, internal feedback on this pin

Select Input Decoding for CY2309

S2	S1	CLOCK A1–A4	CLOCK B1–B4	CLKOUT ^[4]	Output Source	PLL Shutdown
0	0	Three-state	Three-state	Driven	PLL	N
0	1	Driven	Three-state	Driven	PLL	N
1	0	Driven	Driven	Driven	Reference	Y
1	1	Driven	Driven	Driven	PLL	N

Figure 3. REF. Input to CLKA/CLKB Delay vs. Loading Difference between CLKOUT and CLKA/CLKB Pins

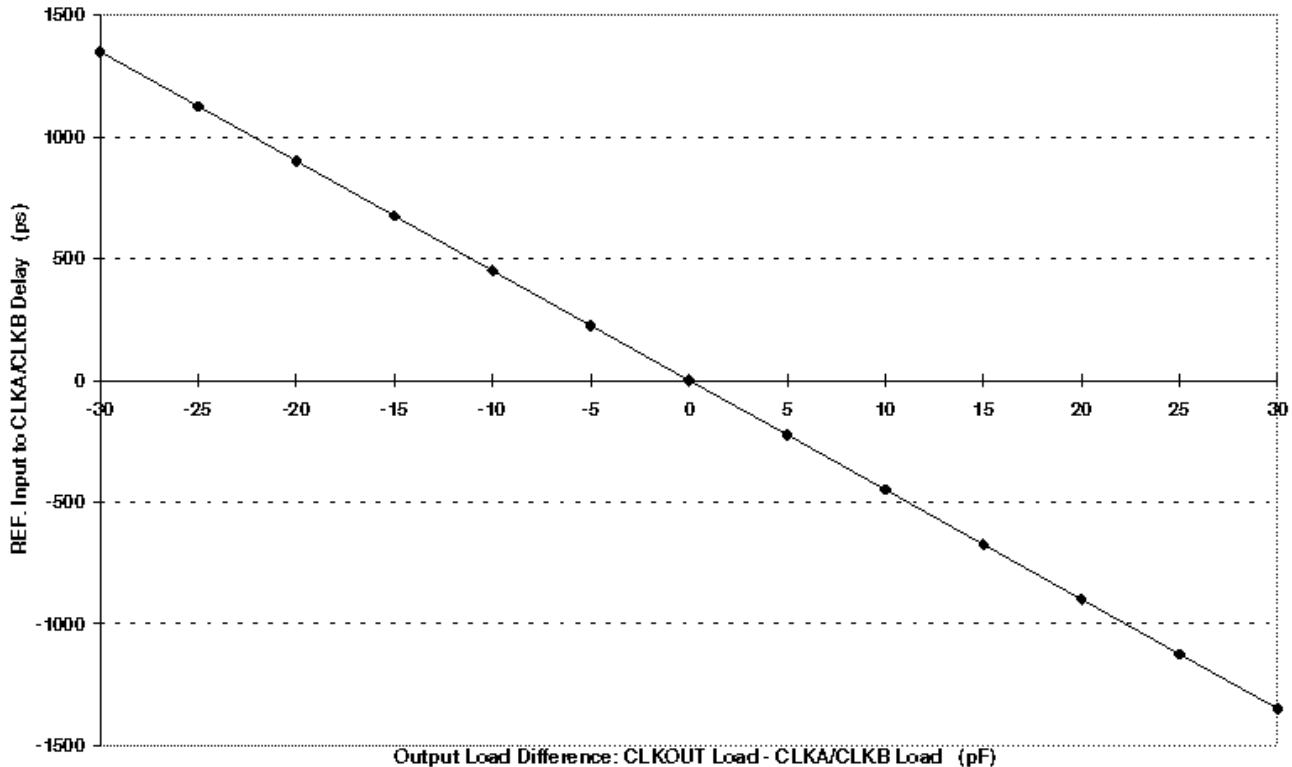

Zero Delay and Skew Control

All outputs must be uniformly loaded to achieve Zero Delay between the input and output. Since the CLKOUT pin is the internal feedback to the PLL, its relative loading can adjust the input-output delay. This is shown in the above graph.

For applications requiring zero input-output delay, all outputs, including CLKOUT, must be equally loaded. Even if CLKOUT is not used, it must have a capacitive load, equal to that on other outputs, for obtaining zero input-output delay. If input to output delay adjustments are required, use the above graph to calculate loading differences between the CLKOUT pin and other outputs.

For zero output-output skew, be sure to load all outputs equally. For further information refer to the application note entitled “CY2305 and CY2309 as PCI and SDRAM Buffers.”

Notes

- This output is driven and has an internal feedback for the PLL. The load on this output can be adjusted to change the skew between the reference and output.

Absolute Maximum Conditions

Supply Voltage to Ground Potential.....	-0.5V to +7.0V	Junction Temperature.....	150°C
DC Input Voltage (Except REF)	-0.5V to $V_{DD} + 0.5V$	Static Discharge Voltage	
DC Input Voltage REF	-0.5V to 7V	(per MIL-STD-883, Method 3015)	> 2,000V
Storage Temperature	-65°C to +150°C		

Operating Conditions for CY2305SC-XX and CY2309SC-XX Commercial Temperature Devices

Parameter	Description	Min	Max	Unit
V_{DD}	Supply Voltage	3.0	3.6	V
T_A	Operating Temperature (Ambient Temperature)	0	70	°C
C_L	Load Capacitance, below 100 MHz	-	30	pF
C_L	Load Capacitance, from 100 MHz to 133 MHz	-	10	pF
C_{IN}	Input Capacitance	-	7	pF
t_{PU}	Power up time for all V_{DDs} to reach minimum specified voltage (power ramps must be monotonic)	0.05	50	ms

Electrical Characteristics for CY2305SC-XX and CY2309SC-XX Commercial Temperature Devices

Parameter	Description	Test Conditions	Min	Max	Unit
V_{IL}	Input LOW Voltage ^[5]		-	0.8	V
V_{IH}	Input HIGH Voltage ^[5]		2.0	-	V
I_{IL}	Input LOW Current	$V_{IN} = 0V$	-	50.0	μA
I_{IH}	Input HIGH Current	$V_{IN} = V_{DD}$	-	100.0	μA
V_{OL}	Output LOW Voltage ^[6]	$I_{OL} = 8\text{ mA} (-1)$ $I_{OH} = 12\text{ mA} (-1H)$	-	0.4	V
V_{OH}	Output HIGH Voltage ^[6]	$I_{OH} = -8\text{ mA} (-1)$ $I_{OL} = -12\text{ mA} (-1H)$	2.4	-	V
I_{DD} (PD mode)	Power Down Supply Current	REF = 0 MHz	-	25.0	μA
I_{DD}	Supply Current	Unloaded outputs at 66.67 MHz, SEL inputs at V_{DD}	-	32.0	mA

Switching Characteristics for CY2305SC-1 and CY2309SC-1 Commercial Temperature Devices

Parameter ^[7]	Name	Test Conditions	Min	Typ.	Max	Unit
t_1	Output Frequency	30-pF load 10 pF load	10 10	-	100 133.33	MHz MHz
t_{DC}	Duty Cycle ^[6] = $t_2 \div t_1$	Measured at 1.4V, $F_{out} = 66.67$ MHz	40.0	50.0	60.0	%
t_3	Rise Time ^[6]	Measured between 0.8V and 2.0V	-	-	2.50	ns
t_4	Fall Time ^[6]	Measured between 0.8V and 2.0V	-	-	2.50	ns
t_5	Output to Output Skew ^[6]	All outputs equally loaded	-	85	250	ps
t_{6A}	Delay, REF Rising Edge to CLKOUT Rising Edge ^[6]	Measured at $V_{DD}/2$	-	0	±350	ps

Notes

- 5. REF input has a threshold voltage of $V_{DD}/2$.
- 6. Parameter is guaranteed by design and characterization. Not 100% tested in production.

Switching Characteristics for CY2305SC-1 and CY2309SC-1 Commercial Temperature Devices

Parameter ^[7]	Name	Test Conditions	Min	Typ.	Max	Unit
t _{6B}	Delay, REF Rising Edge to CLKOUT Rising Edge ^[6]	Measured at V _{DD} /2. Measured in PLL Bypass Mode, CY2309 device only.	1	5	8.7	ns
t ₇	Device to Device Skew ^[6]	Measured at V _{DD} /2 on the CLKOUT pins of devices	–	–	700	ps
t _J	Cycle to Cycle Jitter ^[6]	Measured at 66.67 MHz, loaded outputs	–	70	200	ps
t _{LOCK}	PLL Lock Time ^[6]	Stable power supply, valid clock presented on REF pin	–	–	1.0	ms

Switching Characteristics for CY2305SC-1H and CY2309SC-1H Commercial Temperature Devices

Parameter ^[7]	Name	Description	Min	Typ.	Max	Unit
t ₁	Output Frequency	30 pF load 10 pF load	10 10	–	100 133.33	MHz MHz
t _{DC}	Duty Cycle ^[6] = t ₂ ÷ t ₁	Measured at 1.4V, F _{out} = 66.67 MHz	40.0	50.0	60.0	%
t ₃	Rise Time ^[6]	Measured between 0.8V and 2.0V	–	–	1.50	ns
t ₄	Fall Time ^[6]	Measured between 0.8V and 2.0V	–	–	1.50	ns
t ₅	Output to Output Skew ^[6]	All outputs equally loaded	–	85	250	ps
t _{6A}	Delay, REF Rising Edge to CLKOUT Rising Edge ^[6]	Measured at V _{DD} /2	–	–	±350	ps
t _{6B}	Delay, REF Rising Edge to CLKOUT Rising Edge ^[6]	Measured at V _{DD} /2. Measured in PLL Bypass Mode, CY2309 device only.	1	5	8.7	ns
t ₇	Device to Device Skew ^[6]	Measured at V _{DD} /2 on the CLKOUT pins of devices	–	–	700	ps
t ₈	Output Slew Rate ^[6]	Measured between 0.8V and 2.0V using Test Circuit #2	1	–		V/ns
t _J	Cycle to Cycle Jitter ^[6]	Measured at 66.67 MHz, loaded outputs	–	60	200	ps
t _{LOCK}	PLL Lock Time ^[6]	Stable power supply, valid clock presented on REF pin	–	–	1.0	ms

Operating Conditions for CY2305SI-XX and CY2309SI-XX Industrial Temperature Devices

Parameter	Description	Min	Max	Unit
V _{DD}	Supply Voltage	3.0	3.6	V
T _A	Operating Temperature (Ambient Temperature)	–40	85	°C
C _L	Load Capacitance, below 100 MHz	–	30	pF
C _L	Load Capacitance, from 100 MHz to 133 MHz	–	10	pF
C _{IN}	Input Capacitance	–	7	pF

Note

7. All parameters specified with loaded outputs.

Electrical Characteristics for CY2305SI-XX and CY2309SI-XX Industrial Temperature Devices

Parameter	Description	Test Conditions	Min	Max	Unit
V _{IL}	Input LOW Voltage ^[5]		–	0.8	V
V _{IH}	Input HIGH Voltage ^[5]		2.0	–	V
I _{IL}	Input LOW Current	V _{IN} = 0V	–	50.0	μA
I _{IH}	Input HIGH Current	V _{IN} = V _{DD}	–	100.0	μA
V _{OL}	Output LOW Voltage ^[6]	I _{OL} = 8 mA (–1) I _{OH} = 12 mA (–1H)	–	0.4	V
V _{OH}	Output HIGH Voltage ^[6]	I _{OH} = –8 mA (–1) I _{OL} = –12 mA (–1H)	2.4	–	V
I _{DD} (PD mode)	Power down Supply Current	REF = 0 MHz	–	25.0	μA
I _{DD}	Supply Current	Unloaded outputs at 66.67 MHz, SEL inputs at V _{DD}	–	35.0	mA

Switching Characteristics for CY2305SI-1 and CY2309SI-1 Industrial Temperature Devices

Parameter ^[7]	Name	Test Conditions	Min	Typ.	Max	Unit
t ₁	Output Frequency	30 pF load 10 pF load	10 10	–	100 133.33	MHz MHz
t _{DC}	Duty Cycle ^[6] = t ₂ ÷ t ₁	Measured at 1.4V, F _{out} = 66.67 MHz	40.0	50.0	60.0	%
t ₃	Rise Time ^[6]	Measured between 0.8V and 2.0V	–	–	2.50	ns
t ₄	Fall Time ^[6]	Measured between 0.8V and 2.0V	–	–	2.50	ns
t ₅	Output to Output Skew ^[6]	All outputs equally loaded	–	85	250	ps
t _{6A}	Delay, REF Rising Edge to CLKOUT Rising Edge ^[6]	Measured at V _{DD} /2	–	–	±350	ps
t _{6B}	Delay, REF Rising Edge to CLKOUT Rising Edge ^[6]	Measured at V _{DD} /2. Measured in PLL Bypass Mode, CY2309 device only.	1	5	8.7	ns
t ₇	Device to Device Skew ^[6]	Measured at V _{DD} /2 on the CLKOUT pins of devices	–	–	700	ps
t _J	Cycle to Cycle Jitter ^[6]	Measured at 66.67 MHz, loaded outputs	–	70	200	ps
t _{LOCK}	PLL Lock Time ^[6]	Stable power supply, valid clock presented on REF pin	–	–	1.0	ms

Switching Characteristics for CY2305SI-1H and CY2309SI-1H Industrial Temperature Devices

Parameter ^[7]	Name	Description	Min	Typ.	Max	Unit
t ₁	Output Frequency	30 pF load 10 pF load	10 10	–	100 133.33	MHz MHz
t _{DC}	Duty Cycle ^[6] = t ₂ ÷ t ₁	Measured at 1.4V, F _{out} = 66.67 MHz	40.0	50.0	60.0	%
t ₃	Rise Time ^[6]	Measured between 0.8V and 2.0V	–	–	1.50	ns
t ₄	Fall Time ^[6]	Measured between 0.8V and 2.0V	–	–	1.50	ns
t ₅	Output to Output Skew ^[6]	All outputs equally loaded	–	85	250	ps
t _{6A}	Delay, REF Rising Edge to CLKOUT Rising Edge ^[6]	Measured at V _{DD} /2	–	–	±350	ps
t _{6B}	Delay, REF Rising Edge to CLKOUT Rising Edge ^[6]	Measured at V _{DD} /2. Measured in PLL Bypass Mode, CY2309 device only.	1	5	8.7	ns
t ₇	Device to Device Skew ^[6]	Measured at V _{DD} /2 on the CLKOUT pins of devices	–	–	700	ps

Switching Characteristics for CY2305SI-1H and CY2309SI-1H Industrial Temperature Devices

Parameter ^[7]	Name	Description	Min	Typ.	Max	Unit
t_8	Output Slew Rate ^[6]	Measured between 0.8V and 2.0V using Test Circuit #2	1	–	–	V/ns
t_J	Cycle to Cycle Jitter ^[6]	Measured at 66.67 MHz, loaded outputs	–	60	200	ps
t_{LOCK}	PLL Lock Time ^[6]	Stable power supply, valid clock presented on REF pin	–	–	1.0	ms

Switching Waveforms

Figure 4. Duty Cycle Timing

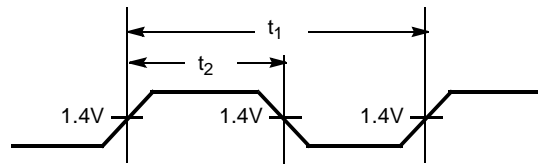

Figure 5. All Outputs Rise/Fall Time

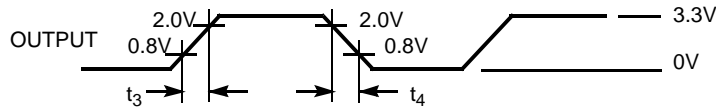

Figure 6. Output-Output Skew

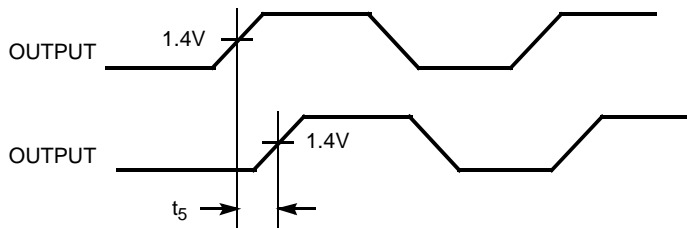

Figure 7. Input-Output Propagation Delay

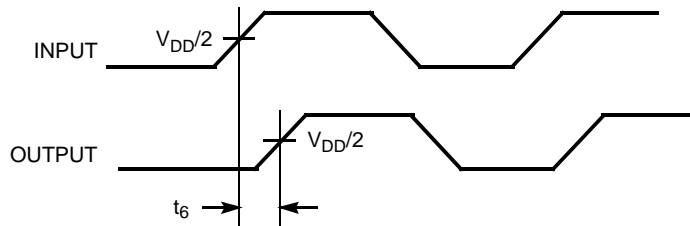
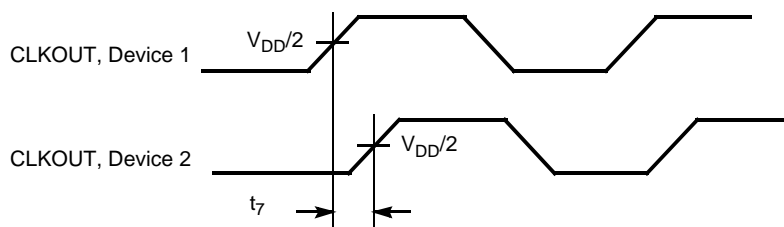
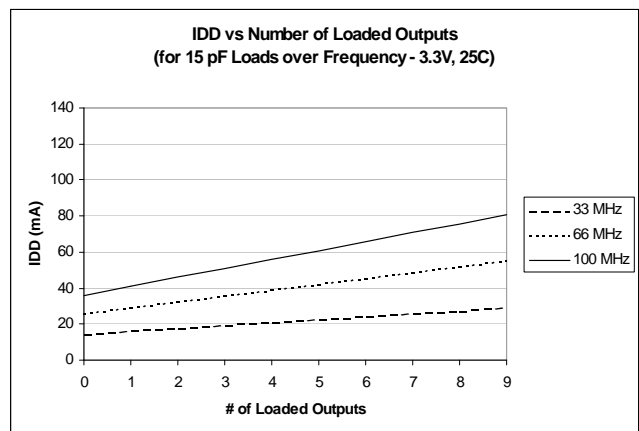
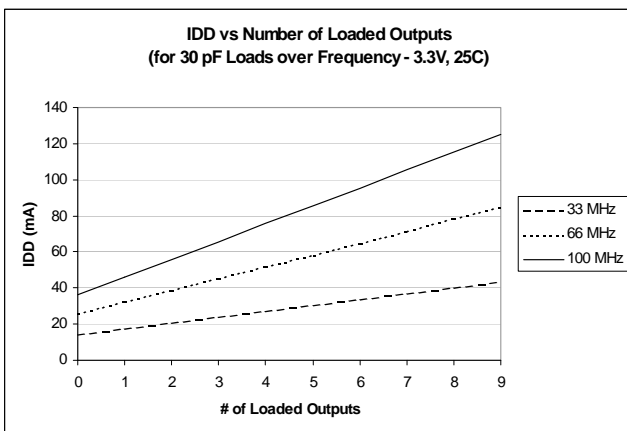
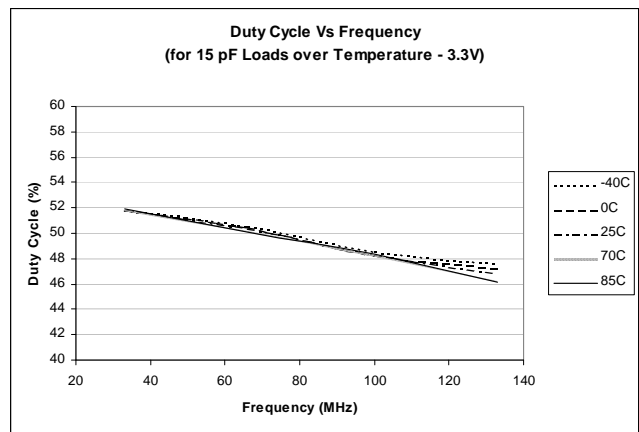
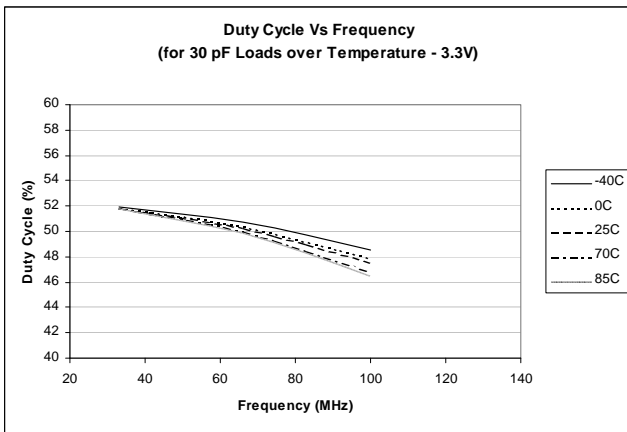
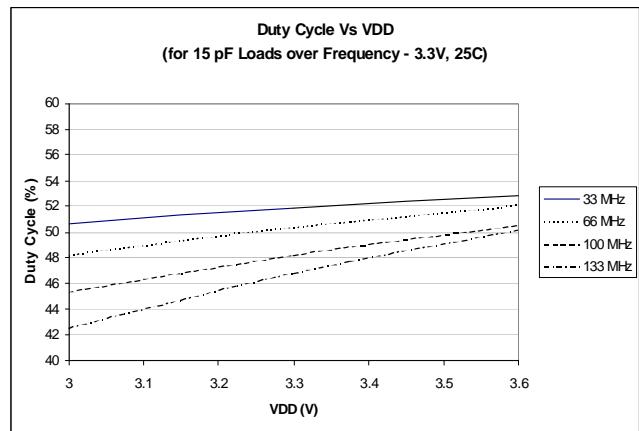
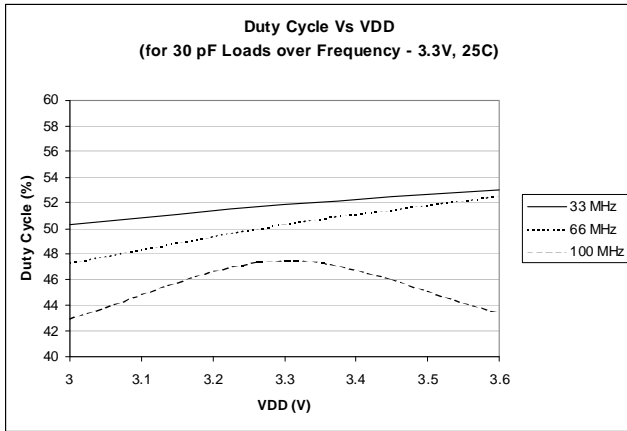

Figure 8. Device-Device Skew



Typical Duty Cycle^[8] and I_{DD} Trends^[9] for CY2305-1 and CY2309-1



Notes

- 8. Duty Cycle is taken from typical chip measured at 1.4V.
- 9. I_{DD} data is calculated from I_{DD} = I_{CORE} + nCVf, where I_{CORE} is the unloaded current. (n = # of outputs; C = Capacitance load per output (F); V = Supply Voltage (V); f = frequency (Hz)).

Typical Duty Cycle^[8] and IDD Trends^[9] for CY2305-1H and CY2309-1H

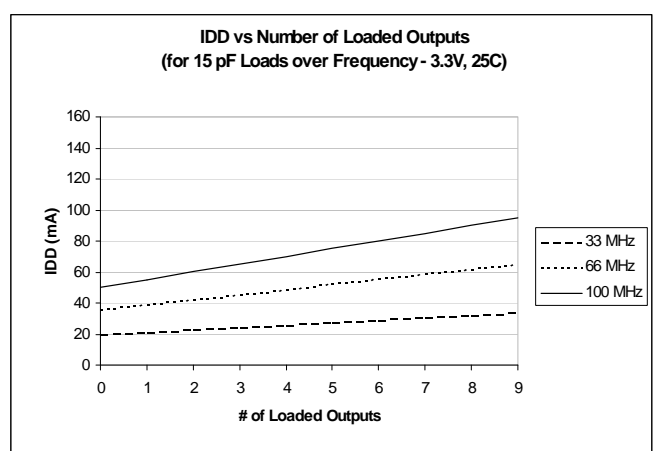
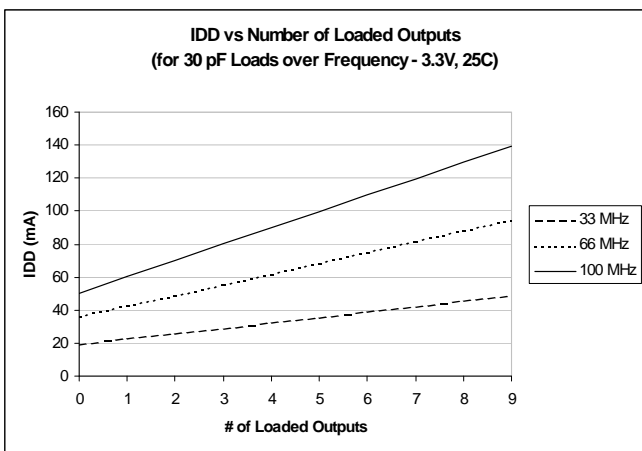
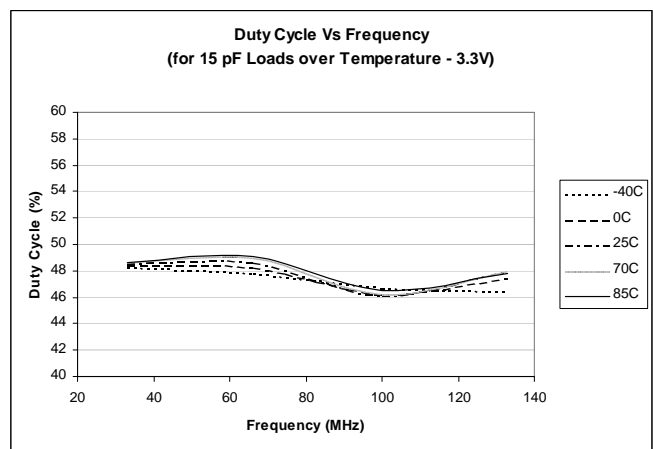
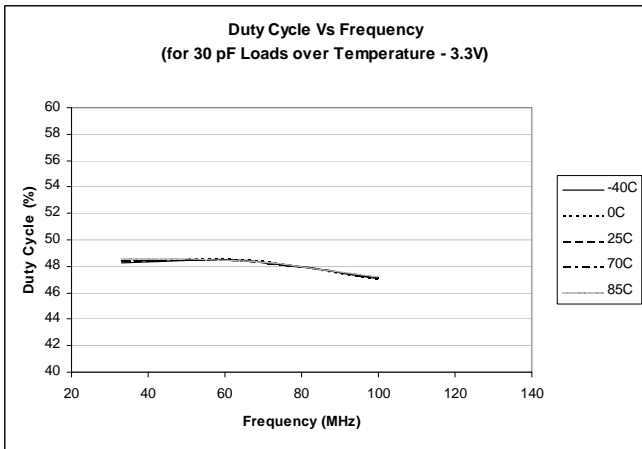
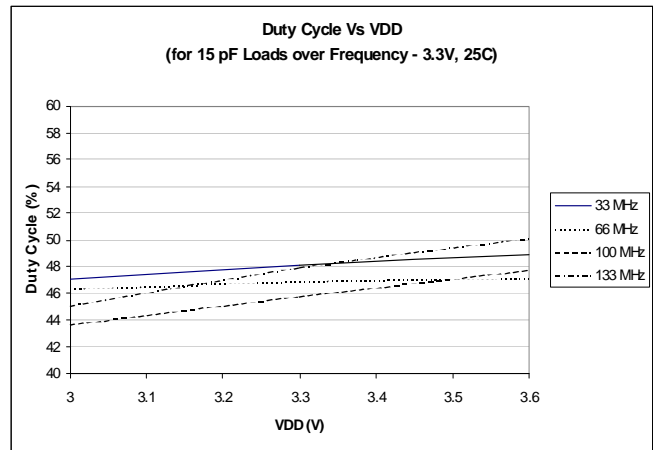
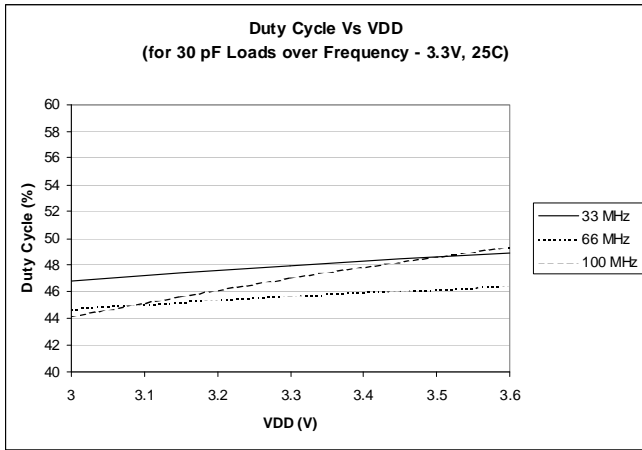

Test Circuits

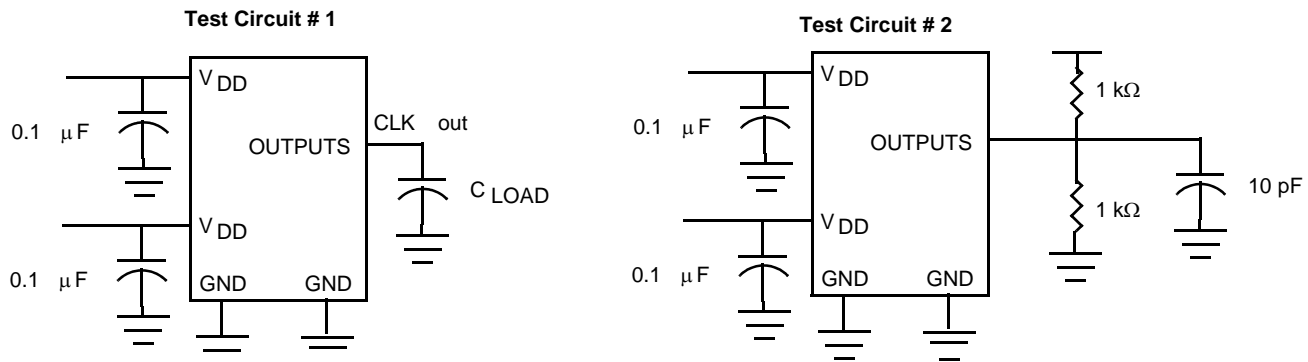

For parameter t_8 (output slew rate) on -1H devices

Ordering Information for CY2305

Ordering Code	Package Type	Operating Range
CY2305SC-1 ^[10]	8-pin 150-mil SOIC	Commercial
CY2305SC-1T ^[10]	8-pin 150-mil SOIC – Tape and Reel	Commercial
CY2305SI-1 ^[10]	8-pin 150-mil SOIC	Industrial
CY2305SI-1T ^[10]	8-pin 150-mil SOIC – Tape and Reel	Industrial
CY2305SC-1H ^[10]	8-pin 150-mil SOIC	Commercial
CY2305SC-1HT ^[10]	8-pin 150-mil SOIC – Tape and Reel	Commercial
CY2305SI-1H ^[10]	8-pin 150-mil SOIC	Industrial
CY2305SI-1HT ^[10]	8-pin 150-mil SOIC – Tape and Reel	Industrial
Pb-Free		
CY2305SXC-1	8-pin 150-mil SOIC	Commercial
CY2305SXC-1T	8-pin 150-mil SOIC – Tape and Reel	Commercial
CY2305SXI-1	8-pin 150-mil SOIC	Industrial
CY2305SXI-1T	8-pin 150-mil SOIC – Tape and Reel	Industrial
CY2305SXC-1H	8-pin 150-mil SOIC	Commercial
CY2305SXC-1HT	8-pin 150-mil SOIC – Tape and Reel	Commercial
CY2305SXI-1H	8-pin 150-mil SOIC	Industrial
CY2305SXI-1HT	8-pin 150-mil SOIC – Tape and Reel	Industrial

Ordering Information for CY2309

Ordering Code	Package Type	Operating Range
CY2309SC-1 ^[10]	16-pin 150-mil SOIC	Commercial
CY2309SC-1T ^[10]	16-pin 150-mil SOIC – Tape and Reel	Commercial
CY2309SI-1 ^[10]	16-pin 150-mil SOIC	Industrial
CY2309SI-1T ^[10]	16-pin 150-mil SOIC – Tape and Reel	Industrial
CY2309SC-1H ^[10]	16-pin 150-mil SOIC	Commercial

Note

10. Not recommended for new designs.

Ordering Information for CY2309 (continued)

Ordering Code	Package Type	Operating Range
CY2309SC-1HT ^[10]	16-pin 150-mil SOIC – Tape and Reel	Commercial
CY2309ZC-1H ^[10]	16-pin 4.4-mm TSSOP	Commercial
CY2309ZC-1HT ^[10]	16-pin 4.4-mm TSSOP – Tape and Reel	Commercial
CY2309SI-1H ^[10]	16-pin 150-mil SOIC	Industrial
CY2309SI-1HT ^[10]	16-pin 150-mil SOIC – Tape and Reel	Industrial
Pb-Free		
CY2309SXC-1	16-pin 150-mil SOIC	Commercial
CY2309SXC-1T	16-pin 150-mil SOIC – Tape and Reel	Commercial
CY2309SXI-1	16-pin 150-mil SOIC	Industrial
CY2309SXI-1T	16-pin 150-mil SOIC – Tape and Reel	Industrial
CY2309SXC-1H	16-pin 150-mil SOIC	Commercial
CY2309SXC-1HT	16-pin 150-mil SOIC – Tape and Reel	Commercial
CY2309SXI-1H	16-pin 150-mil SOIC	Industrial
CY2309SXI-1HT	16-pin 150-mil SOIC – Tape and Reel	Industrial
CY2309ZXC-1H	16-pin 4.4-mm TSSOP	Commercial
CY2309ZXC-1HT	16-pin 4.4-mm TSSOP – Tape and Reel	Commercial
CY2309ZXI-1H	16-pin 4.4-mm TSSOP	Industrial
CY2309ZXI-1HT	16-pin 4.4-mm TSSOP – Tape and Reel	Industrial

Package Drawing and Dimensions

Figure 8. 8-Pin (150-Mil) SOIC S8

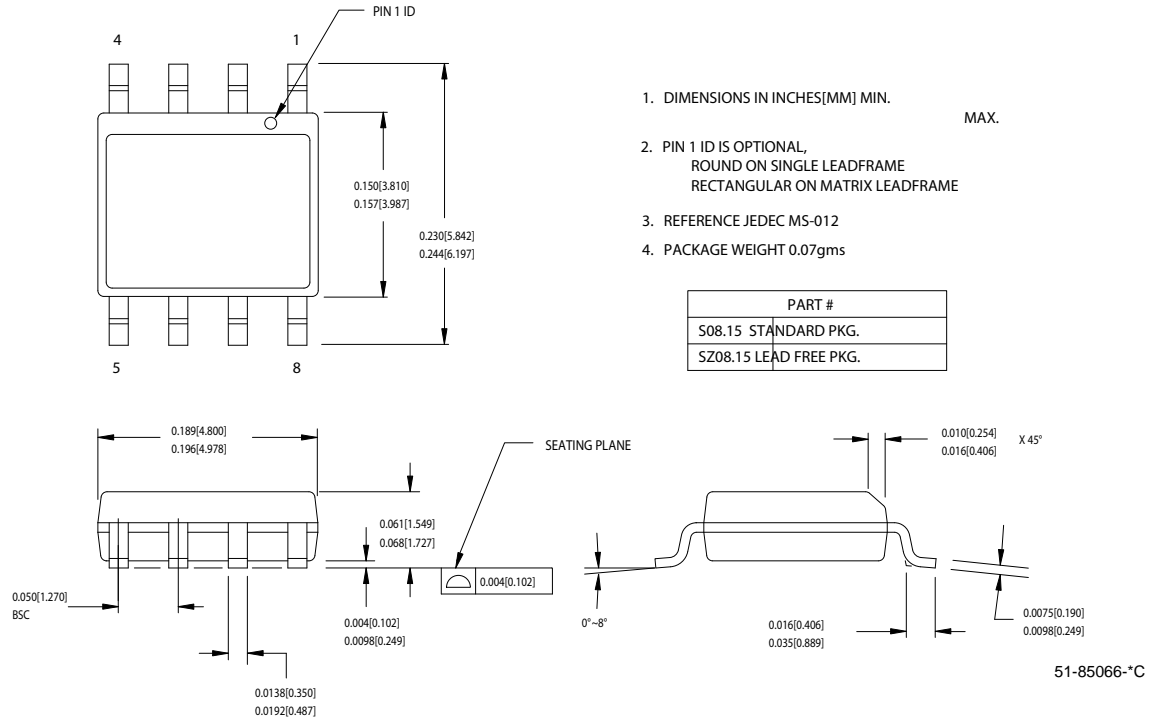
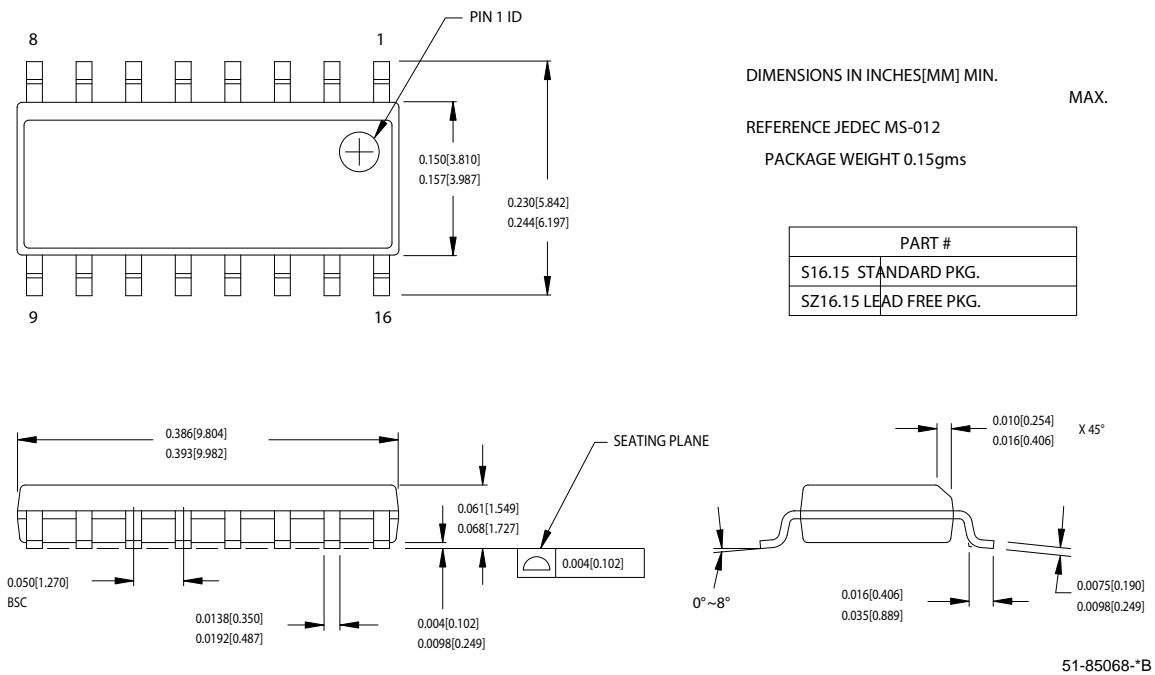
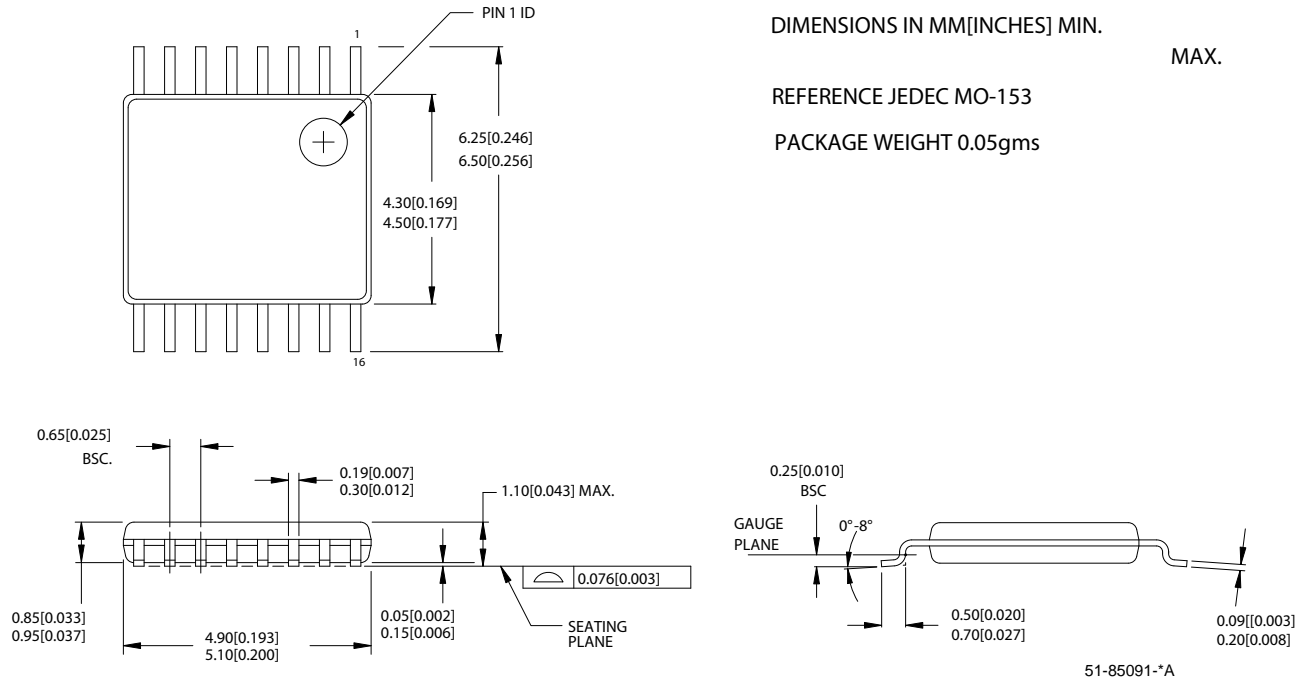

Figure 9. 16-Pin (150-Mil) SOIC S16



Package Drawing and Dimensions (continued)

Figure 10. 16-Pin TSSOP 4.40 MM Body Z16.173



Document History Page

Document Title: CY2305/CY2309 Low-Cost 3.3V Zero Delay Buffer				
Document Number: 38-07140				
REV.	ECN	Orig. of Change	Submission Date	Description of Change
**	110249	SZV	10/19/01	Change from Spec number: 38-00530 to 38-07140
*A	111117	CKN	03/01/02	Added t6B row to the Switching Characteristics Table; also added the letter "A" to the t6A row Corrected the table title from CY2305SC-IH and CY2309SC-IH to CY2305SI-IH and CY2309SI-IH
*B	117625	HWT	10/21/02	Added eight-pin TSSOP packages (CY2305ZC-1 and CY2305ZC-1T) to the ordering information table. Added the Tape and Reel option to all the existing packages: CY2305SC-1T, CY2305SI-1T, CY2305SC-1HT, CY2305SI-1HT, CY2305ZC-1T, CY2309SC-1T, CY2309SI-1T, CY2309SC-1HT, CY2309SI-1HT, CY2309ZC-1HT, CY2309ZI-1HT
*C	121828	RBI	12/14/02	Power up requirements added to Operating Conditions information
*D	131503	RGL	12/12/03	Added Lead-free for all the devices in the ordering information table
*E	214083	RGL	See ECN	Added a Lead-free with the new coding for all SOIC devices in the ordering information table
*F	291099	RGL	See ECN	Added TSSOP Lead-free devices
*G	390582	RGL	See ECN	Added typical values for jitter
*H	2542461	AESA	07/23/08	Updated template. Added Note "Not recommended for new designs." Added part number CY2305ESXC-1, CY2305ESXC-1T, CY2305ESXI-1, CY2305ESXI-1T, CY2305ESXC-1H, CY2305ESXC-1HT, CY2305ESXI-1H, CY2305ESXI-1HT, CY2309ESXC-1, CY2309ESXC-1T, CY2309ESXI-1, CY2309ESXI-1T, CY2309ESXC-1H, CY2309ESXC-1HT, CY2309ESXI-1H, CY2309ESXI-1HT, CY2309EZXC-1H, CY2309EZXC-1HT, CY2309EZXI-1H, and CY2309EZXI-1HT in ordering information table. Removed part number CY2305SZC-1, CY2305SZC-1T, CY2305SZI-1, CY2305SZI-1T, CY2305SZC-1H, CY2305SZC-1HT, CY2305SZI-1H, CY2305SZI-1HT, CY2309SZC-1, CY2309SZC-1T, CY2309SZI-1, CY2309SZI-1T, CY2309SZC-1H, CY2309SZC-1HT, CY2309SZI-1H, CY2309SZI-1HT, CY2309ZZC-1H, CY2309ZZC-1HT, CY2309ZI-1H, CY2309ZI-1HT, CY2309ZZI-1H, and CY2309ZZI-1HT in Ordering Information table. Changed Lead-Free to Pb-Free.
*I	2565153	AESA	09/18/08	Removed part number CY2305ESXC-1, CY2305ESXC-1T, CY2305ESXI-1, CY2305ESXI-1T, CY2305ESXC-1H, CY2305ESXC-1HT, CY2305ESXI-1H, CY2305ESXI-1HT, CY2309ESXC-1, CY2309ESXC-1T, CY2309ESXI-1, CY2309ESXI-1T, CY2309ESXC-1H, CY2309ESXC-1HT, CY2309ESXI-1H, CY2309ESXI-1HT, CY2309EZXC-1H, CY2309EZXC-1HT, CY2309EZXI-1H, and CY2309EZXI-1HT in ordering information table. Removed note references to note 10 in Pb-Free sections of ordering information table. Changed IDD (PD mode) from 12.0 to 25.0 μ A for commercial temperature devices Deleted Duty Cycle parameters for $F_{out} < 50$ MHz commercial and industrial devices.

Sales, Solutions, and Legal Information

Worldwide Sales and Design Support

Cypress maintains a worldwide network of offices, solution centers, manufacturer's representatives, and distributors. To find the office closest to you, visit us at cypress.com/sales.

Products

PSoC	psoc.cypress.com
Clocks & Buffers	clocks.cypress.com
Wireless	wireless.cypress.com
Memories	memory.cypress.com
Image Sensors	image.cypress.com

PSoC Solutions

General	psoc.cypress.com/solutions
Low Power/Low Voltage	psoc.cypress.com/low-power
Precision Analog	psoc.cypress.com/precision-analog
LCD Drive	psoc.cypress.com/lcd-drive
CAN 2.0b	psoc.cypress.com/can
USB	psoc.cypress.com/usb

© Cypress Semiconductor Corporation, 2001-2008. The information contained herein is subject to change without notice. Cypress Semiconductor Corporation assumes no responsibility for the use of any circuitry other than circuitry embodied in a Cypress product. Nor does it convey or imply any license under patent or other rights. Cypress products are not warranted nor intended to be used for medical, life support, life saving, critical control or safety applications, unless pursuant to an express written agreement with Cypress. Furthermore, Cypress does not authorize its products for use as critical components in life-support systems where a malfunction or failure may reasonably be expected to result in significant injury to the user. The inclusion of Cypress products in life-support systems application implies that the manufacturer assumes all risk of such use and in doing so indemnifies Cypress against all charges.

Any Source Code (software and/or firmware) is owned by Cypress Semiconductor Corporation (Cypress) and is protected by and subject to worldwide patent protection (United States and foreign), United States copyright laws and international treaty provisions. Cypress hereby grants to licensee a personal, non-exclusive, non-transferable license to copy, use, modify, create derivative works of, and compile the Cypress Source Code and derivative works for the sole purpose of creating custom software and or firmware in support of licensee product to be used only in conjunction with a Cypress integrated circuit as specified in the applicable agreement. Any reproduction, modification, translation, compilation, or representation of this Source Code except as specified above is prohibited without the express written permission of Cypress.

Disclaimer: CYPRESS MAKES NO WARRANTY OF ANY KIND, EXPRESS OR IMPLIED, WITH REGARD TO THIS MATERIAL, INCLUDING, BUT NOT LIMITED TO, THE IMPLIED WARRANTIES OF MERCHANTABILITY AND FITNESS FOR A PARTICULAR PURPOSE. Cypress reserves the right to make changes without further notice to the materials described herein. Cypress does not assume any liability arising out of the application or use of any product or circuit described herein. Cypress does not authorize its products for use as critical components in life-support systems where a malfunction or failure may reasonably be expected to result in significant injury to the user. The inclusion of Cypress' product in a life-support systems application implies that the manufacturer assumes all risk of such use and in doing so indemnifies Cypress against all charges.

Use may be limited by and subject to the applicable Cypress software license agreement.