

## 阅读申明

- 1.本站收集的数据手册和产品资料都来自互联网，版权归原作者所有。如读者和版权方有任何异议请及时告之，我们将妥善解决。
- 2.本站提供的中文数据手册是英文数据手册的中文翻译，其目的是协助用户阅读，该译文无法自动跟随原稿更新，同时也可能存在翻译上的不当。建议读者以英文原稿为参考以便获得更精准的信息。
- 3.本站提供的产品资料，来自厂商的技术支持或者使用者的心得体会等，其内容可能存在描述上的差异，建议读者做出适当判断。
- 4.如需与我们联系，请发邮件到marketing@iczoom.com，主题请标有“数据手册”字样。

## Read Statement

1. The datasheets and other product information on the site are all from network reference or other public materials, and the copyright belongs to the original author and original published source. If readers and copyright owners have any objections, please contact us and we will deal with it in a timely manner.
2. The Chinese datasheets provided on the website is a Chinese translation of the English datasheets. Its purpose is for reader's learning exchange only and do not involve commercial purposes. The translation cannot be automatically updated with the original manuscript, and there may also be improper translations. Readers are advised to use the English manuscript as a reference for more accurate information.
3. All product information provided on the website refer to solutions from manufacturers' technical support or users the contents may have differences in description, and readers are advised to take the original article as the standard.
4. If you have any questions, please contact us at marketing@iczoom.com and mark the subject with "Datasheets" .

4-bit REAL TIME CLOCK MODULE

RTC - 62421  
RTC - 62423

- Built-in crystal unit allows adjustment-free efficient operation.
- 24 h / 12 h changeable and leap year automatically adjustable (Gregorian calendar).
- Pins and functions are compatible with the MSM6242 series.



Product Number (Please contact us)  
RTC-62421 : Q42624211xxxx00  
RTC-62423 : Q42624231xxxx00

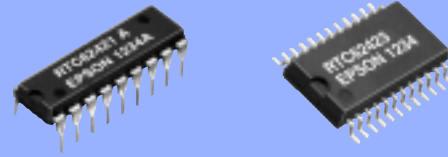

Actual size

RTC-62421

RTC-62423



Block diagram

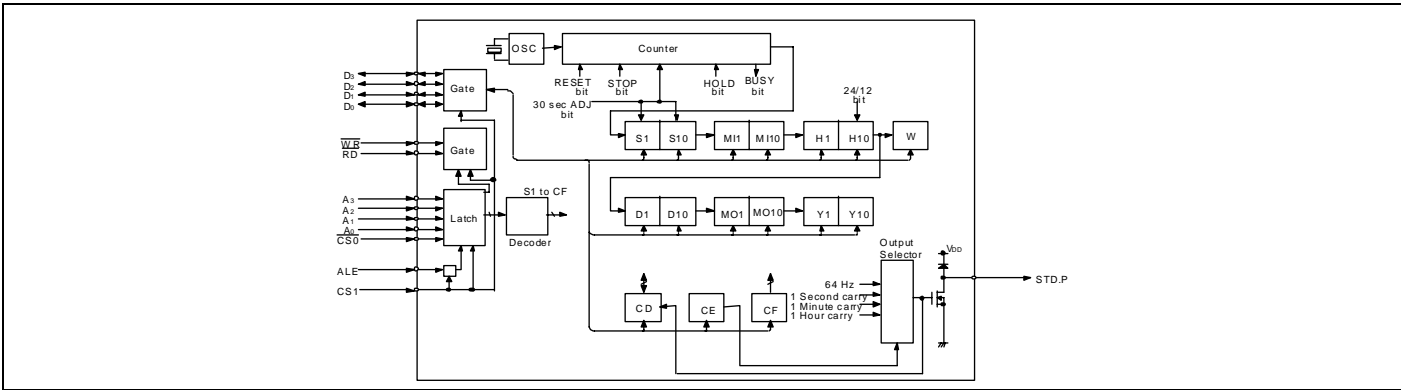

Terminal connection/External dimensions

(Unit:mm)

● RTC-62421 (DIP 18-pin)

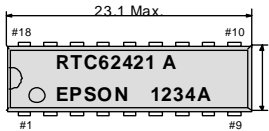

No.	Pin terminal	No.	Pin terminal
1	STD.P	18	VDD
2	/CS0	17	(VDD)
3	ALE	16	(VDD)
4	A0	15	CS1
5	A1	14	C0
6	A2	13	D1
7	A3	12	D2
8	/RD	11	D3
9	GND	10	/WR

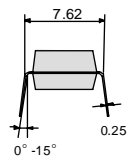
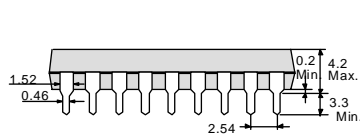

● RTC-62423 (SOP 24-pin)

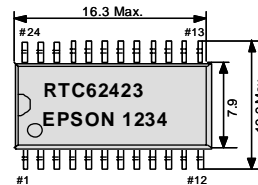

No.	Pin terminal	No.	Pin terminal
1	STD.P	24	VDD
2	/CS0	23	(VDD)
3	N.C.	22	(VDD)
4	ALE	21	N.C.
5	A0	20	CS1
6	N.C.	19	D0
7	A1	18	N.C.
8	N.C.	17	N.C.
9	A2	16	D1
10	A3	15	D2
11	/RD	14	D3
12	GND	13	/WR

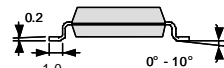
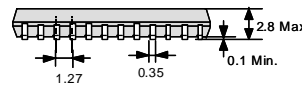

Metal may be exposed on the top or bottom of this product. This will not affect any quality, reliability or electrical spec.

Specifications (characteristics)

\*Refer to application manual for details.

Absolute Max. rating

Item	Symbol	Condition	Min.	Max.	Unit
Supply voltage	V <sub>DD</sub>	T <sub>a</sub> =+25 °C	-0.3	+7.0	V
Input voltage	V <sub>IO</sub>	T <sub>a</sub> =+25 °C	GND-0.3	V <sub>DD</sub> +0.3	V
Storage temperature *	T <sub>STG</sub>	RTC-62421	-55	+85	°C
		RTC-62423	-55	+125	

\*Stored as bare product after unpacking

Operating range

Item	Symbol	Condition	Min.	Max.	Unit
Power voltage	V <sub>DD</sub>	—	4.5	5.5	V
Clock voltage	V <sub>CLK</sub>	—	2.0	5.5	V
Operating temperature	T <sub>OPR</sub>	Stored as bare product after unpacking	-40	+85	°C

Frequency characteristics

Item	Symbol	Condition	Range	Unit
Frequency precision	Δf/f	T <sub>a</sub> =+25 °C V <sub>DD</sub> =5.0 V	62421A	±10
			62421B	±50
			62423A	±20
			62423	±50
Frequency temperature characteristics	T <sub>OP</sub>	-10 °C to +70 °C (+25 °C)	+10 / -120	
		-40 °C to +85 °C (+25 °C)	+10 / -220	
Frequency voltage characteristics	f/V	T <sub>a</sub> =+25 °C, V <sub>DD</sub> =4.5 V to 5.5 V	±5.0 Max.	×10 <sup>-6</sup> /V
Aging	fa	T <sub>a</sub> =+25 °C, V <sub>DD</sub> =5.0 V, First year	±5.0 Max.	×10 <sup>-6</sup> /year

DC characteristics

Item	Symbol	Condition	Min.	Typ.	Max.	Unit	Applicable terminal
Current consumption	I <sub>DD1</sub>	CS1=0 V V <sub>DD</sub> =5 V V <sub>DD</sub> =2 V	—	15	30	μA	—
	I <sub>DD2</sub>		—	1	1.8		
HIGH input voltage (1)	V <sub>IH1</sub>	—	2.2	—	—	V	All inputs other than CS1
LOW input voltage (1)	V <sub>IL1</sub>		—	—	0.8		
LOW output voltage (1)	V <sub>OL1</sub>	I <sub>OL</sub> =2.5 mA	—	—	0.4	V	D0 to D3
HIGH output voltage	V <sub>OH</sub>	I <sub>OH</sub> =-400 μA	2.4	—	—		
LOW output voltage (2)	V <sub>OL2</sub>	I <sub>OL</sub> =2.5 mA	—	—	0.4	V	STD.P
OFF leak current	I <sub>OFFLK</sub>	V <sub>I</sub> =V <sub>DD</sub> /0 V	—	—	10/-10		
Input capacity	C <sub>I</sub>	Input frequency 1 MHz	—	5	—	pF	Input Pins
HIGH input voltage (2)	V <sub>IH2</sub>	V <sub>DD</sub> =2.0 V to 5.5 V	4/5 V <sub>DD</sub>	—	—	V	CS1
LOW input voltage (2)	V <sub>IL2</sub>		—	—	1/5 V <sub>DD</sub>		
Input leak current (1)	I <sub>LK1</sub>	V <sub>I</sub> =V <sub>DD</sub> /0 V	—	—	1/-1	μA	Input other than D0 to D3
Input leak current (2)	I <sub>LK2</sub>		—	—	10/-10		

# “QMEMS” EPSON TOYOCOM

In order to meet customer needs in a rapidly advancing digital, broadband and ubiquitous society, we are committed to offering products that are one step ahead of the market and a rank above the rest in quality. To achieve our goals, we follow a “3D (three device) strategy” designed to drive both horizontal and vertical growth. We will to grow our three device categories of “Timing Devices”, “Sensing Devices” and “Optical Devices”, and expand vertical growth through a combination of products from these categories.

A Quartz MEMS is any high added value quartz device that exploits the characteristics of quartz crystal material but that is produced using MEMS (micro-electro-mechanical system) processing technology.

Market needs are advancing faster than previously imagined toward smaller, more stable crystal products, but we will stay ahead of the curve by rolling out products that exceed market speed and quality requirements. We want to further accelerate the 3D strategy by QMEMS.

Quartz devices have become crucial in the network environment where products are increasingly intended for broadband, ubiquitous applications and where various types of terminals can transfer information almost immediately via LAN and WAN on a global scale. Epson Toyocom Corporation addresses every single aspect within a network environment. The new corporation offers “Digital Convergence” solutions to problems arising with products for consumer use, such as, core network systems and automotive systems.



## PROMOTION OF ENVIRONMENTAL MANAGEMENT SYSTEM CONFORMING TO INTERNATIONAL STANDARDS

At Epson Toyocom, all environmental initiatives operate under the Plan-Do-Check-Action(PDCA) cycle designed to achieve continuous improvements. The environmental management system (EMS) operates under the ISO 14001 environmental management standard.

All of our major manufacturing and non-manufacturing sites, in Japan and overseas, completed the acquisition of ISO 14001 certification. In the future, new group companies will be expected to acquire the certification around the third year of operations.

ISO 14000 is an international standard for environmental management that was established by the International Standards Organization in 1996 against the background of growing concern regarding global warming, destruction of the ozone layer and global deforestation

## WORKING FOR HIGH QUALITY

In order to provide high quality and reliable products and services than meet customer needs, Epson Toyocom made early efforts towards obtaining ISO9000 series certification and has acquired ISO9001 for all business establishments in Japan and abroad. We have also acquired ISO/TS 16949 certification that is requested strongly by major automotive manufacturers as standard.

QS-9000 is an enhanced standard for quality assurance systems formulated by leading U.S. automobile manufacturers based on the international ISO 9000 series.

ISO/TS 16949 is a global standard based on QS-9000, a severe standard corresponding to the requirements from the automobile industry.

### ► Explanation of the mark that are using it for the catalog

	<ul style="list-style-type: none"> <li>► Pb free.</li> <li>► Complies with EU RoHS directive.</li> </ul>
	<ul style="list-style-type: none"> <li>► Pb free terminal designed. Contains Pb in products exempted by RoHS directive. (Contains Pb in sealing glass, high melting temperature type solder or other.)</li> <li>► Complies with EU RoHS directive.</li> </ul>
	<ul style="list-style-type: none"> <li>► The products have been designed for high reliability applications such as Automotive.</li> </ul>

## Notice

- This material is subject to change without notice.
- Any part of this material may not be reproduced or duplicated in any form or any means without the written permission of Epson Toyocom.
- The information, applied circuitry, programming, usage, etc., written in this material is intended for reference only. Epson Toyocom does not assume any liability for the occurrence of infringing on any patent or copyright of a third party. This material does not authorize the licensing for any patent or intellectual copyrights.
- Any product described in this material may contain technology or the subject relating to strategic products under the control of the Foreign Exchange and Foreign Trade Law of Japan and may require an export license from the Ministry of International Trade and Industry or other approval from another government agency.
- You are requested not to use the products (and any technical information furnished, if any) for the development and/or manufacture of weapon of mass destruction or for other military purposes. You are also requested that you would not make the products available to any third party who may use the products for such prohibited purposes.
- These products are intended for general use in electronic equipment. When using them in specific applications that require extremely high reliability, such as the applications stated below, you must obtain permission from Epson Toyocom in advance.
  - / Space equipment (artificial satellites, rockets, etc.) / Transportation vehicles and related (automobiles, aircraft, trains, vessels, etc.)
  - / Medical instruments to sustain life / Submarine transmitters / Power stations and related / Fire work equipment and security equipment
  - / traffic control equipment / and others requiring equivalent reliability.
- In this new crystal master for Epson Toyocom, product codes and markings will remain as previously identified prior to the merger. Due to the on-going strategy of gradual unification of part numbers, please review product codes and markings, as they will change during the course of the coming months.

We apologize for the inconvenience, but we will eventually have a unified part numbering system for Epson Toyocom that will be user friendly.