

阅读申明

- 1.本站收集的数据手册和产品资料都来自互联网，版权归原作者所有。如读者和版权方有任何异议请及时告之，我们将妥善解决。
- 2.本站提供的中文数据手册是英文数据手册的中文翻译，其目的是协助用户阅读，该译文无法自动跟随原稿更新，同时也可能存在翻译上的不当。建议读者以英文原稿为参考以便获得更精准的信息。
- 3.本站提供的产品资料，来自厂商的技术支持或者使用者的心得体会等，其内容可能存在描述上的差异，建议读者做出适当判断。
- 4.如需与我们联系，请发邮件到marketing@iczoom.com，主题请标有“数据手册”字样。

Read Statement

1. The datasheets and other product information on the site are all from network reference or other public materials, and the copyright belongs to the original author and original published source. If readers and copyright owners have any objections, please contact us and we will deal with it in a timely manner.
2. The Chinese datasheets provided on the website is a Chinese translation of the English datasheets. Its purpose is for reader's learning exchange only and do not involve commercial purposes. The translation cannot be automatically updated with the original manuscript, and there may also be improper translations. Readers are advised to use the English manuscript as a reference for more accurate information.
3. All product information provided on the website refer to solutions from manufacturers' technical support or users the contents may have differences in description, and readers are advised to take the original article as the standard.
4. If you have any questions, please contact us at marketing@iczoom.com and mark the subject with "Datasheets" .

LMV1012 Analog Series: Pre-Amplified IC's for High Gain 2-Wire Microphones

Check for Samples: [LMV1012](#)

FEATURES

- **Typical LMV1012-15, 2.2V Supply, $R_L = 2.2\text{ k}\Omega$, $C = 2.2\text{ }\mu\text{F}$, $V_{IN} = 18\text{ mV}_{PP}$, Unless Otherwise Specified**
- **Supply Voltage: 2V - 5V**
- **Supply Current: $<180\text{ }\mu\text{A}$**
- **Signal to Noise Ratio (A-Weighted): 60 dB**
- **Output Voltage Noise (A-Weighted): -89 dBV**
- **Total Harmonic Distortion: 0.09%**
- **Voltage Gain**
 - LMV1012-07: 7.8 dB
 - LMV1012-15: 15.6 dB
 - LMV1012-20: 20.9 dB
 - LMV1012-25: 23.8 dB
- **Temperature Range: -40°C to 85°C**
- **Offered in 4-Bump DSBGA Packages**

APPLICATIONS

- Cellular Phones
- Headsets
- Mobile Communications
- Automotive Accessories
- PDAs
- Accessory Microphone Products

Schematic Diagram

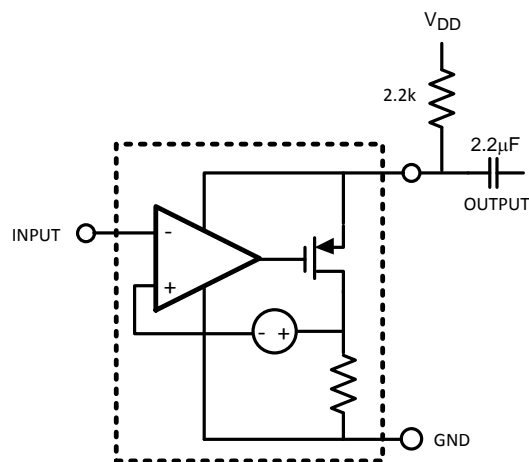

DESCRIPTION

The LMV1012 is an audio amplifier series for small form factor electret microphones. This 2-wire portfolio is designed to replace the JFET amplifier currently being used. The LMV1012 series is ideally suited for applications requiring high signal integrity in the presence of ambient or RF noise, such as in cellular communications. The LMV1012 audio amplifiers are specified to operate over a 2.2V to 5.0V supply voltage range with fixed gains of 7.8 dB, 15.6 dB, 20.9 dB, and 23.8 dB. The devices offer excellent THD, gain accuracy and temperature stability as compared to a JFET microphone.

The LMV1012 series enables a two-pin electret microphone solution, which provides direct pin-to-pin compatibility with the existing JFET market.

The devices are offered in extremely thin space saving 4-bump DSBGA packages. The LMV1012XP is designed for 1.0 mm canisters and thicker ECM canisters. These extremely miniature packages are designed for electret condenser microphones (ECM) form factor.

Built-In Gain Electret Microphone

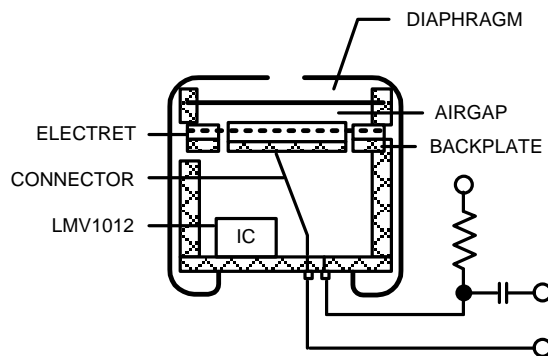

Please be aware that an important notice concerning availability, standard warranty, and use in critical applications of Texas Instruments semiconductor products and disclaimers thereto appears at the end of this data sheet.

All trademarks are the property of their respective owners.



This integrated circuit can be damaged by ESD. Texas Instruments recommends that all integrated circuits be handled with appropriate precautions. Failure to observe proper handling and installation procedures can cause damage.

ESD damage can range from subtle performance degradation to complete device failure. Precision integrated circuits may be more susceptible to damage because very small parametric changes could cause the device not to meet its published specifications.

Absolute Maximum Ratings⁽¹⁾⁽²⁾

ESD Tolerance ⁽³⁾	Human Body Model	2500V
	Machine Model	250V
Supply Voltage	V _{DD} - GND	5.5V
Storage Temperature Range		-65°C to 150°C
Junction Temperature ⁽⁴⁾		150°C max
Mounting Temperature	Infrared or Convection (20 sec.)	235°C

- (1) Absolute Maximum Ratings indicate limits beyond which damage to the device may occur. Operating Ratings indicate conditions for which the device is intended to be functional, but specific performance is not ensured. For ensured specifications and the test conditions, see the [5V Electrical Characteristics](#).
- (2) If Military/Aerospace specified devices are required, please contact the Texas Instruments Sales Office/ Distributors for availability and specifications.
- (3) Human Body Model (HBM) is 1.5 kΩ in series with 100 pF.
- (4) The maximum power dissipation is a function of T_{J(MAX)}, θ_{JA} and T_A. The maximum allowable power dissipation at any ambient temperature is P_D = (T_{J(MAX)} - T_A)/θ_{JA}. All numbers apply for packages soldered directly into a PC board.

Operating Ratings⁽¹⁾

Supply Voltage	2V to 5V
Temperature Range	-40°C to 85°C

- (1) Absolute Maximum Ratings indicate limits beyond which damage to the device may occur. Operating Ratings indicate conditions for which the device is intended to be functional, but specific performance is not ensured. For ensured specifications and the test conditions, see the [5V Electrical Characteristics](#).

2.2V Electrical Characteristics⁽¹⁾

Unless otherwise specified, all limits are specified for $T_J = 25^\circ\text{C}$, $V_{DD} = 2.2\text{V}$, $V_{IN} = 18\text{ mV}$, $R_L = 2.2\text{ k}\Omega$ and $C = 2.2\text{ }\mu\text{F}$.

Boldface limits apply at the temperature extremes.

Symbol	Parameter	Conditions	Min ⁽²⁾	Typ ⁽³⁾	Max ⁽²⁾	Units	
I_{DD}	Supply Current	$V_{IN} = \text{GND}$	LMV1012-07		139	250 300	μA
			LMV1012-15		180	300 325	
			LMV1012-20		160	250 300	
			LMV1012-25		141	250 300	
SNR	Signal to Noise Ratio	$f = 1\text{ kHz}$, $V_{IN} = 18\text{ mV}$, A-Weighted	LMV1012-07		59		dB
			LMV1012-15		60		
			LMV1012-20		61		
			LMV1012-25		61		
V_{IN}	Max Input Signal	$f = 1\text{ kHz}$ and THD+N < 1%	LMV1012-07		170		mV _{PP}
			LMV1012-15		100		
			LMV1012-20		50		
			LMV1012-25		28		
V_{OUT}	Output Voltage	$V_{IN} = \text{GND}$	LMV1012-07	1.65 1.54	1.90	2.03 2.09	V
			LMV1012-15	1.54 1.48	1.81	1.94 2.00	
			LMV1012-20	1.65 1.55	1.85	2.03 2.13	
			LMV1012-25	1.65 1.49	1.90	2.02 2.18	
f_{LOW}	Lower -3dB Roll Off Frequency	$R_{SOURCE} = 50\Omega$		65		Hz	
f_{HIGH}	Upper -3dB Roll Off Frequency	$R_{SOURCE} = 50\Omega$		95		kHz	
e_n	Output Noise	A-Weighted	LMV1012-07		-96		dBV
			LMV1012-15		-89		
			LMV1012-20		-84		
			LMV1012-25		-82		
THD	Total Harmonic Distortion	$f = 1\text{ kHz}$, $V_{IN} = 18\text{ mV}$	LMV1012-07		0.10		%
			LMV1012-15		0.09		
			LMV1012-20		0.12		
			LMV1012-25		0.15		
C_{IN}	Input Capacitance			2		pF	
Z_{IN}	Input Impedance			>1000		G Ω	
A_V	Gain	$f = 1\text{ kHz}$, $R_{SOURCE} = 50\Omega$	LMV1012-07	6.4 5.5	7.8	9.5 10.0	dB
			LMV1012-15	14.0 13.1	15.6	16.9 17.5	
			LMV1012-20	19.5 17.4	20.9	22.0 23.3	
			LMV1012-25	22.5 21.4	23.8	25.0 25.7	

(1) Electrical Table values apply only for factory testing conditions at the temperature indicated. Factory testing conditions result in very limited self-heating of the device such that $T_J = T_A$. No specification of parametric performance is indicated in the electrical tables under conditions of internal self-heating where $T_J > T_A$.

(2) All limits are specified by design or statistical analysis.

(3) Typical values represent the most likely parametric norm.

5V Electrical Characteristics⁽¹⁾

Unless otherwise specified, all limits are specified for $T_J = 25^\circ\text{C}$, $V_{DD} = 5\text{V}$, $V_{IN} = 18\text{mV}$, $R_L = 2.2\text{k}\Omega$ and $C = 2.2\text{ }\mu\text{F}$.

Boldface limits apply at the temperature extremes.

Symbol	Parameter	Conditions		Min ⁽²⁾	Typ ⁽³⁾	Max ⁽²⁾	Units
I_{DD}	Supply Current	$V_{IN} = \text{GND}$	LMV1012-07		158	250 300	μA
			LMV1012-15		200	300 325	
			LMV1012-20		188	260 310	
			LMV1012-25		160	250 300	
SNR	Signal to Noise Ratio	$f = 1\text{ kHz}$, $V_{IN} = 18\text{ mV}$, A-Weighted	LMV1012-07		59		dB
			LMV1012-15		60		
			LMV1012-20		61		
			LMV1012-25		61		
V_{IN}	Max Input Signal	$f = 1\text{ kHz}$ and THD+N < 1%	LMV1012-07		170		mV_{PP}
			LMV1012-15		100		
			LMV1012-20		55		
			LMV1012-25		28		
V_{OUT}	Output Voltage	$V_{IN} = \text{GND}$	LMV1012-07	4.45 4.38	4.65	4.80 4.85	V
			LMV1012-15	4.34 4.28	4.56	4.74 4.80	
			LMV1012-20	4.40 4.30	4.58	4.75 4.85	
			LMV1012-25	4.45 4.39	4.65	4.83 4.86	
f_{LOW}	Lower -3dB Roll Off Frequency	$R_{SOURCE} = 50\Omega$			67		Hz
f_{HIGH}	Upper -3dB Roll Off Frequency	$R_{SOURCE} = 50\Omega$			150		kHz
e_n	Output Noise	A-Weighted	LMV1012-07		-96		dBV
			LMV1012-15		-89		
			LMV1012-20		-84		
			LMV1012-25		-82		
THD	Total Harmonic Distortion	$f = 1\text{ kHz}$, $V_{IN} = 18\text{ mV}$	LMV1012-07		0.12		%
			LMV1012-15		0.13		
			LMV1012-20		0.18		
			LMV1012-25		0.21		
C_{IN}	Input Capacitance				2		pF
Z_{IN}	Input Impedance				>1000		G Ω
A_V	Gain	$f = 1\text{ kHz}$, $R_{SOURCE} = 50\Omega$	LMV1012-07	6.4 5.5	8.1	9.5 10.7	dB
			LMV1012-15	14.0 13.1	15.6	16.9 17.5	
			LMV1012-20	19.2 17.0	21.1	22.3 23.5	
			LMV1012-25	22.5 21.2	23.9	25.0 25.8	

(1) Electrical Table values apply only for factory testing conditions at the temperature indicated. Factory testing conditions result in very limited self-heating of the device such that $T_J = T_A$. No specification of parametric performance is indicated in the electrical tables under conditions of internal self-heating where $T_J > T_A$.

(2) All limits are specified by design or statistical analysis.

(3) Typical values represent the most likely parametric norm.

Connection Diagram

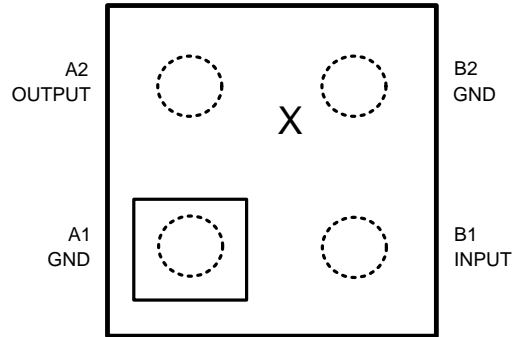

4-Bump DSBGA (Top View)

NOTE

Pin numbers are referenced to package marking text orientation.

The actual physical placement of the package marking will vary slightly from part to part. The package will designate the date code and will vary considerably. Package marking does not correlate to device type in any way.

Typical Performance Characteristics

Unless otherwise specified, $V_S = 2.2V$, $R_L = 2.2\text{ k}\Omega$, $C = 2.2\text{ }\mu\text{F}$, single supply, $T_A = 25^\circ\text{C}$

Supply Current vs. Supply Voltage (LMV1012-07)

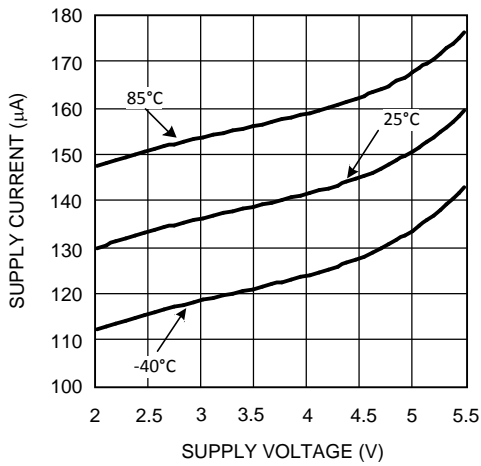

Figure 1.

Supply Current vs. Supply Voltage (LMV1012-15)

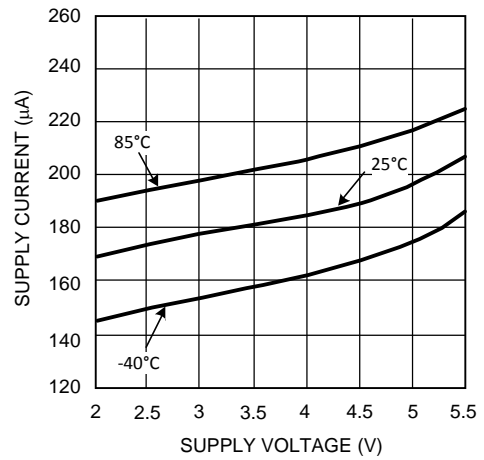

Figure 2.

Supply Current vs. Supply Voltage (LMV1012-20)

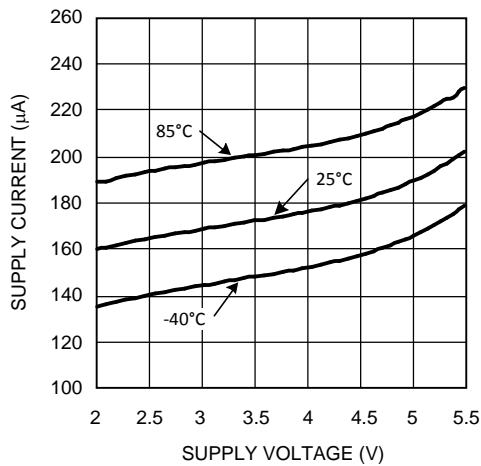

Figure 3.

Supply Current vs. Supply Voltage (LMV1012-25)

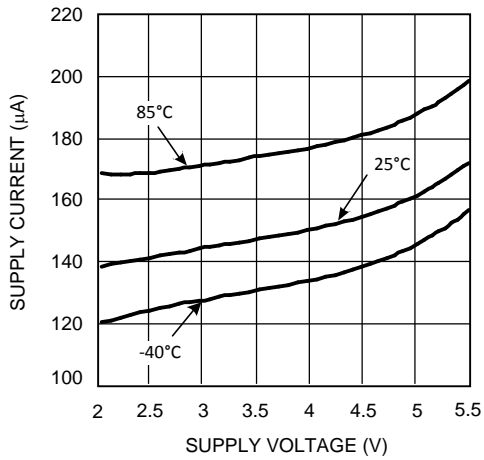

Figure 4.

Gain and Phase vs. Frequency (LMV1012-07)

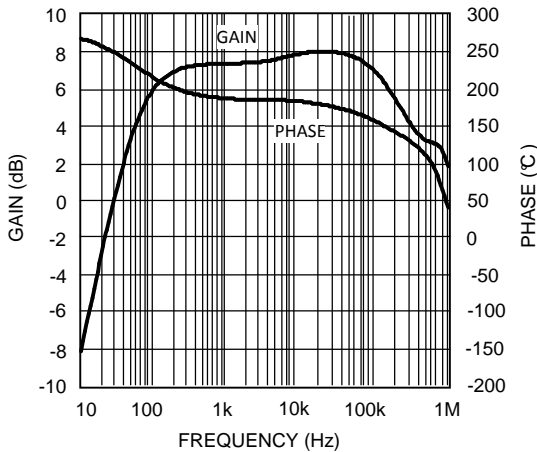

Figure 5.

Gain and Phase vs. Frequency (LMV1012-15)

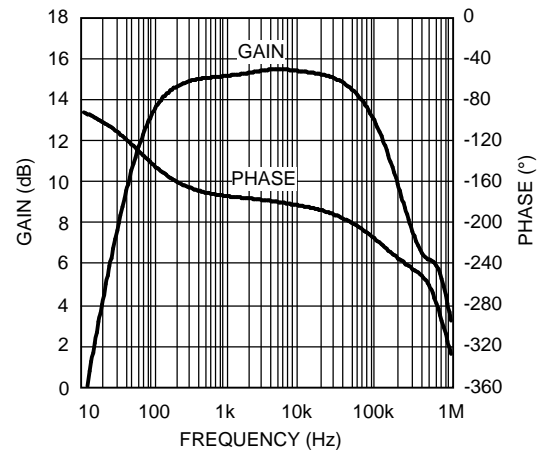

Figure 6.

Typical Performance Characteristics (continued)

Unless otherwise specified, $V_S = 2.2V$, $R_L = 2.2\text{ k}\Omega$, $C = 2.2\text{ }\mu\text{F}$, single supply, $T_A = 25^\circ\text{C}$

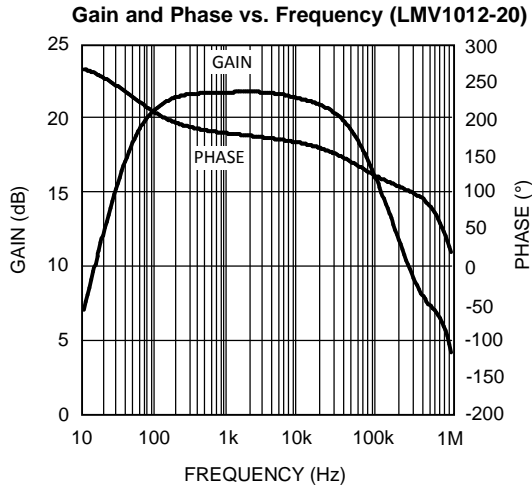

Figure 7.

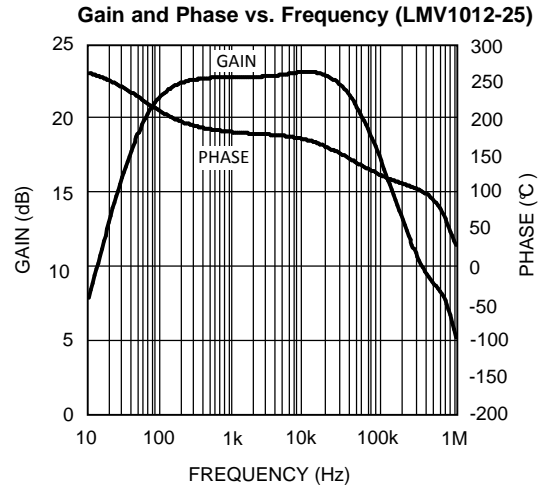

Figure 8.

Total Harmonic Distortion vs. Frequency (LMV1012-07)

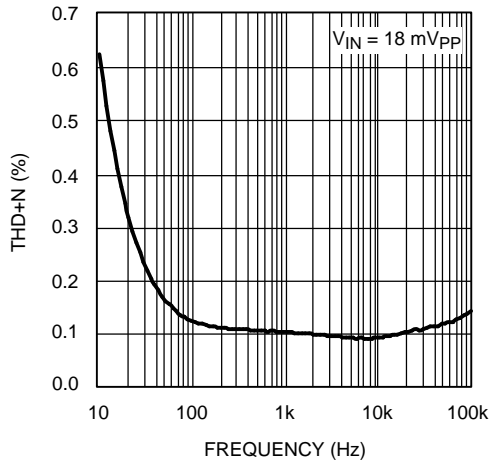

Figure 9.

Total Harmonic Distortion vs. Frequency (LMV1012-15)

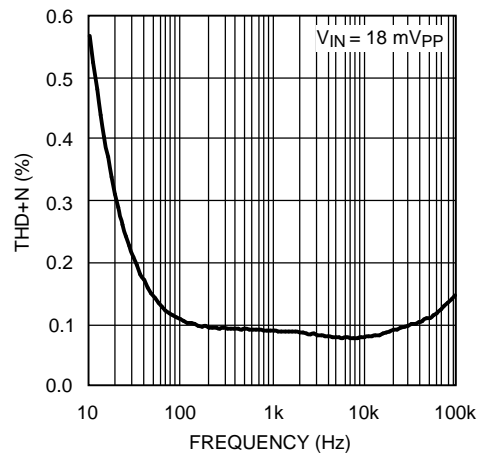

Figure 10.

Total Harmonic Distortion vs. Frequency (LMV1012-20)

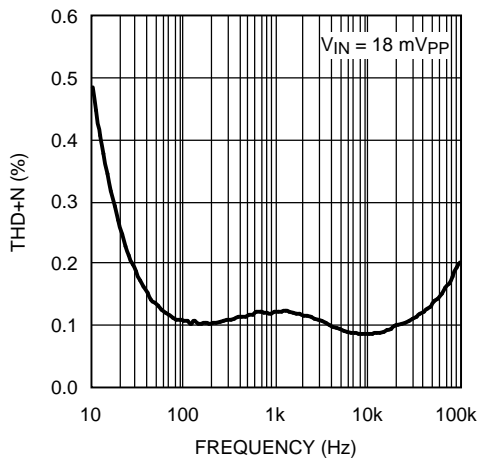

Figure 11.

Total Harmonic Distortion vs. Frequency (LMV1012-25)

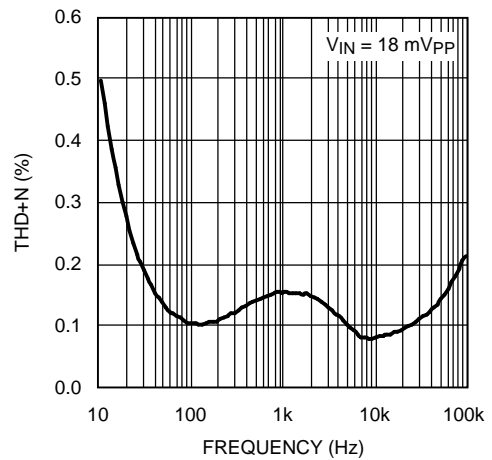

Figure 12.

Typical Performance Characteristics (continued)

Unless otherwise specified, $V_S = 2.2V$, $R_L = 2.2\text{ k}\Omega$, $C = 2.2\text{ }\mu\text{F}$, single supply, $T_A = 25^\circ\text{C}$

Total Harmonic Distortion vs. Input Voltage (LMV1012-07)

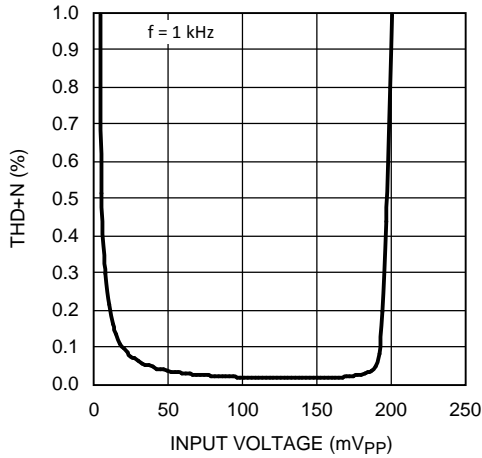

Figure 13.

Total Harmonic Distortion vs. Input Voltage (LMV1012-15)

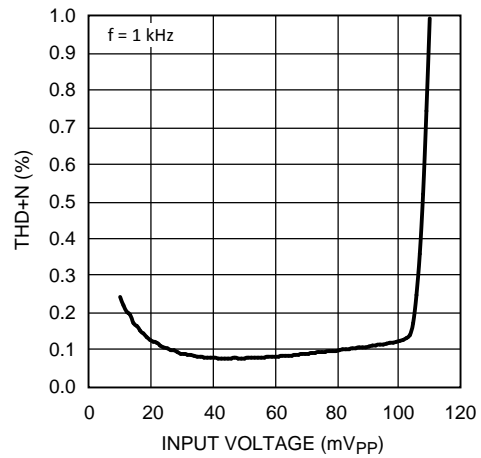

Figure 14.

Total Harmonic Distortion vs. Input Voltage (LMV1012-20)

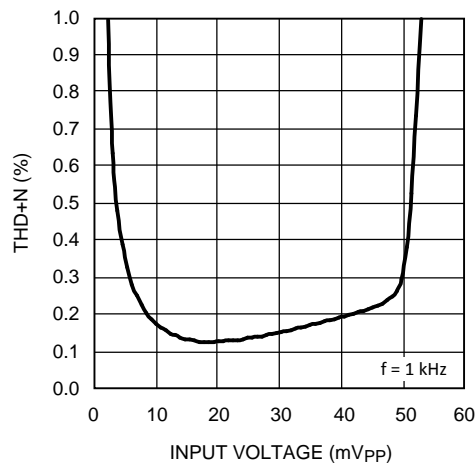

Figure 15.

Total Harmonic Distortion vs. Input Voltage (LMV1012-25)

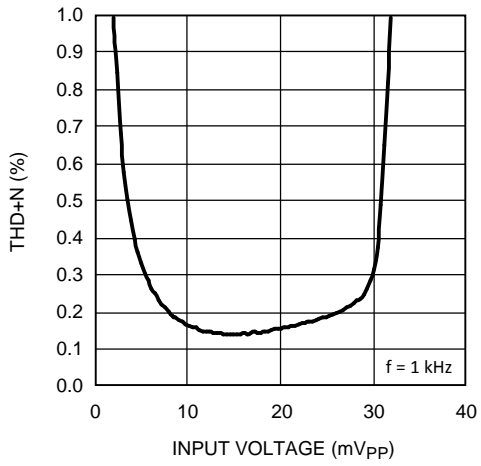

Figure 16.

Output Noise vs. Frequency (LMV1012-07)

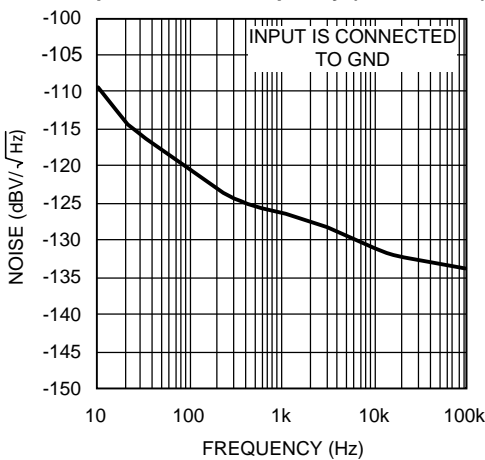

Figure 17.

Output Noise vs. Frequency (LMV1012-15)

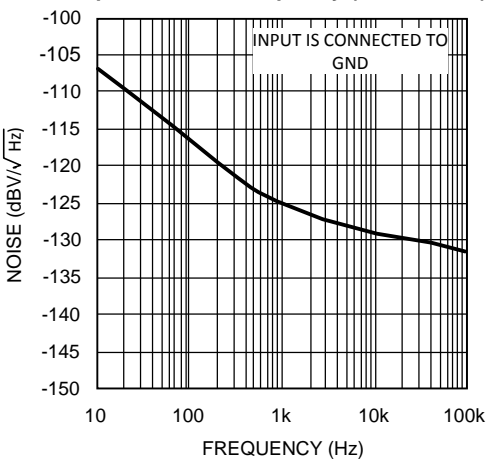

Figure 18.

Typical Performance Characteristics (continued)

Unless otherwise specified, $V_S = 2.2V$, $R_L = 2.2\text{ k}\Omega$, $C = 2.2\text{ }\mu\text{F}$, single supply, $T_A = 25^\circ\text{C}$

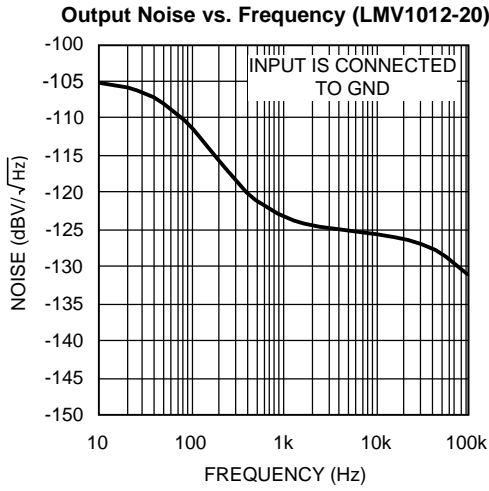

Figure 19.

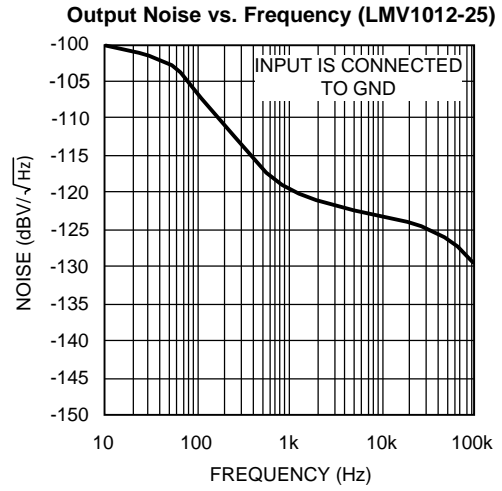

Figure 20.

APPLICATION SECTION

HIGH GAIN

The LMV1012 series provides outstanding gain versus the JFET and still maintains the same ease of implementation, with improved gain, linearity and temperature stability. A high gain eliminates the need for extra external components.

BUILT IN GAIN

The LMV1012 is offered in 0.3 mm height space saving small 4-pin DSBGA packages in order to fit inside the different size ECM canisters of a microphone. The LMV1012 is placed on the PCB inside the microphone.

The bottom side of the PCB usually shows a bull's eye pattern where the outer ring, which is shorted to the metal can, should be connected to the ground. The center dot on the PCB is connected to the V_{DD} through a resistor. This phantom biasing allows both supply voltage and output signal on one connection.

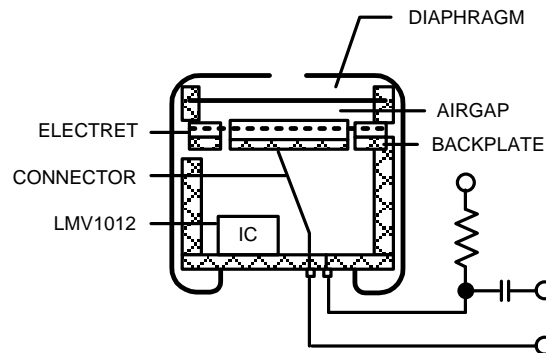

Figure 21. Built in Gain

A-WEIGHTED FILTER

The human ear has a frequency range from 20 Hz to about 20 kHz. Within this range the sensitivity of the human ear is not equal for each frequency. To approach the hearing response weighting filters are introduced. One of those filters is the A-weighted filter.

The A-weighted filter is usually used in signal to noise ratio measurements, where sound is compared to device noise. This filter improves the correlation of the measured data to the signal to noise ratio perceived by the human ear.

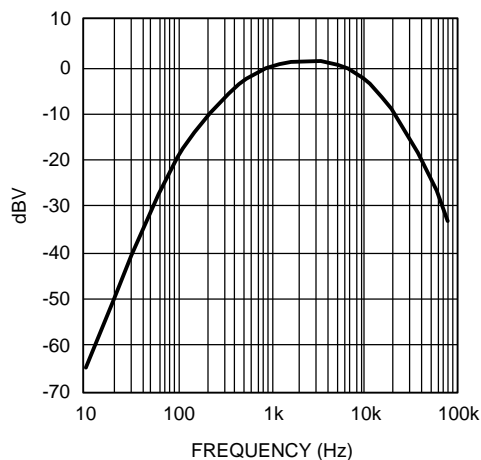

Figure 22. A-Weighted Filter

MEASURING NOISE AND SNR

The overall noise of the LMV1012 is measured within the frequency band from 10 Hz to 22 kHz using an A-weighted filter. The input of the LMV1012 is connected to ground with a 5 pF capacitor, as in Figure 23. Special precautions in the internal structure of the LMV1012 have been taken to reduce the noise on the output.

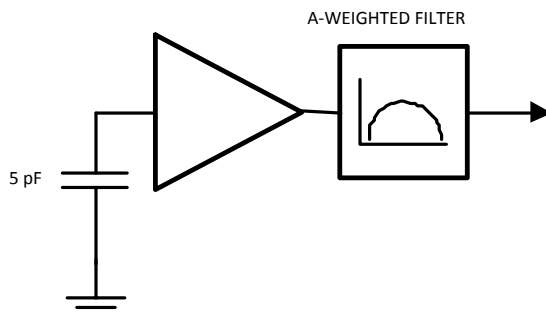

Figure 23. Noise Measurement Setup

The signal to noise ratio (SNR) is measured with a 1 kHz input signal of 18 mV_{pp} using an A-weighted filter. This represents a sound pressure level of 94 dB SPL. No input capacitor is connected for the measurement.

SOUND PRESSURE LEVEL

The volume of sound applied to a microphone is usually stated as a pressure level referred to the threshold of hearing of the human ear. The sound pressure level (SPL) in decibels is defined by:

$$\text{Sound pressure level (dB)} = 20 \log P_m/P_o$$

where

- P_m is the measured sound pressure
- P_o is the threshold of hearing (20 μ Pa).

In order to be able to calculate the resulting output voltage of the microphone for a given SPL, the sound pressure in dB SPL needs to be converted to the absolute sound pressure in dBPa. This is the sound pressure level in decibels referred to 1 Pascal (Pa).

The conversion is given by:

$$\text{dBPa} = \text{dB SPL} + 20 \cdot \log 20 \mu\text{Pa} \tag{2}$$

$$\text{dBPa} = \text{dB SPL} - 94 \text{ dB} \tag{3}$$

Translation from absolute sound pressure level to a voltage is specified by the sensitivity of the microphone. A conventional microphone has a sensitivity of -44 dBV/Pa.

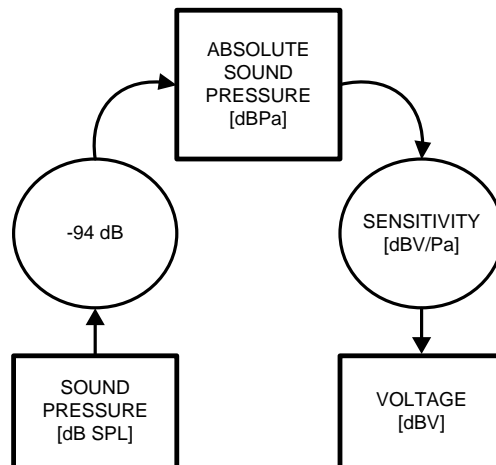

Figure 24. dB SPL to dBV Conversion

Example: Busy traffic is 70 dB SPL

$$V_{\text{OUT}} = 70 - 94 - 44 = -68 \text{ dBV} \quad (4)$$

This is equivalent to 1.13 mV_{PP}

Since the LMV1012-15 has a gain of 6 (15.6 dB) over the JFET, the output voltage of the microphone is 6.78 mV_{PP}. By implementing the LMV1012-15, the sensitivity of the microphone is -28.4 dBV/Pa (-44 + 15.6).

LOW FREQUENCY CUT OFF FILTER

To reduce noise on the output of the microphone a low frequency cut off filter has been implemented. This filter reduces the effect of wind and handling noise.

It's also helpful to reduce the proximity effect in directional microphones. This effect occurs when the sound source is very close to the microphone. The lower frequencies are amplified which gives a bass sound. This amplification can cause an overload, which results in a distortion of the signal.

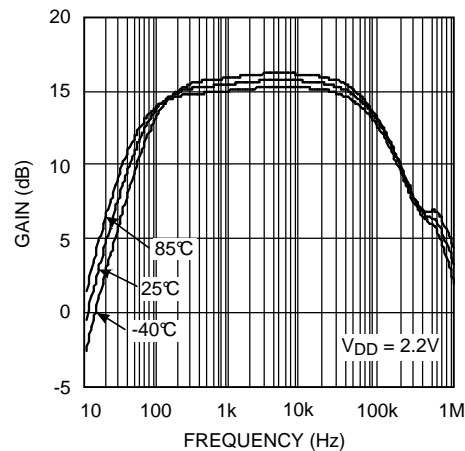

Figure 25. LMV1012-15 Gain vs. Frequency Over Temperature

The LMV1012 is optimized to be used in audio band applications. By using the LMV1012, the gain response is flat within the audio band and has linearity and temperature stability (see [Figure 25](#)).

NOISE

Noise pick-up by a microphone in cell phones is a well-known problem. A conventional JFET circuit is sensitive for noise pick-up because of its high output impedance, which is usually around 2.2 k Ω .

RF noise is amongst other caused by non-linear behavior. The non-linear behavior of the amplifier at high frequencies, well above the usable bandwidth of the device, causes AM-demodulation of high frequency signals. The AM modulation contained in such signals folds back into the audio band, thereby disturbing the intended microphone signal. The GSM signal of a cell phone is such an AM-modulated signal. The modulation frequency of 216 Hz and its harmonics can be observed in the audio band. This kind of noise is called bumblebee noise.

RF noise caused by a GSM signal can be reduced by connecting two external capacitors to ground, see [Figure 26](#). One capacitor reduces the noise caused by the 900 MHz carrier and the other reduces the noise caused by 1800/1900 MHz.

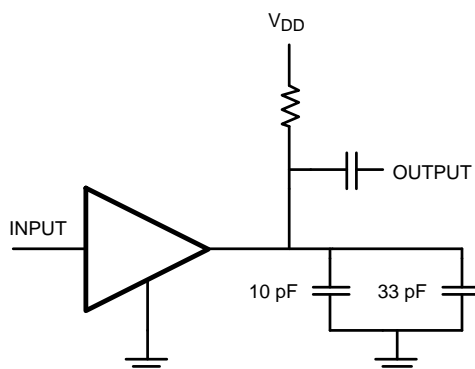

Figure 26. RF Noise Reduction

REVISION HISTORY

Changes from Revision G (May 2013) to Revision H	Page
• Changed layout of National Data Sheet to TI format	13

PACKAGING INFORMATION

Orderable Device	Status (1)	Package Type	Package Drawing	Pins	Package Qty	Eco Plan (2)	Lead/Ball Finish	MSL Peak Temp (3)	Op Temp (°C)	Top-Side Markings (4)	Samples
LMV1012TP-07/NOPB	ACTIVE	DSBGA	YPB	4	250	TBD	Call TI	Call TI			Samples
LMV1012TP-15/NOPB	ACTIVE	DSBGA	YPB	4	250	TBD	Call TI	Call TI			Samples
LMV1012TP-25/NOPB	ACTIVE	DSBGA	YPB	4	250	TBD	Call TI	Call TI			Samples
LMV1012TPX-15/NOPB	ACTIVE	DSBGA	YPB	4	3000	TBD	Call TI	Call TI	-40 to 85		Samples
LMV1012TPX-25/NOPB	ACTIVE	DSBGA	YPB	4	3000	TBD	Call TI	Call TI	-40 to 85		Samples
LMV1012UP-07/NOPB	ACTIVE	DSBGA	YPC	4	250	Green (RoHS & no Sb/Br)	SNAGCU	Level-1-260C-UNLIM			Samples
LMV1012UP-15/NOPB	ACTIVE	DSBGA	YPC	4	250	TBD	Call TI	Call TI			Samples
LMV1012UP-20/NOPB	ACTIVE	DSBGA	YPC	4	250	Green (RoHS & no Sb/Br)	SNAGCU	Level-1-260C-UNLIM			Samples
LMV1012UP-25/NOPB	ACTIVE	DSBGA	YPC	4	250	TBD	Call TI	Call TI			Samples
LMV1012UPX-07/NOPB	ACTIVE	DSBGA	YPC	4	3000	TBD	Call TI	Call TI	-40 to 85		Samples
LMV1012UPX-15/NOPB	ACTIVE	DSBGA	YPC	4	3000	TBD	Call TI	Call TI			Samples
LMV1012UPX-20/NOPB	ACTIVE	DSBGA	YPC	4	3000	Green (RoHS & no Sb/Br)	SNAGCU	Level-1-260C-UNLIM			Samples
LMV1012UPX-25/NOPB	ACTIVE	DSBGA	YPC	4	3000	TBD	Call TI	Call TI	-40 to 85		Samples
LMV1012XP-15/NOPB	ACTIVE	DSBGA	YPE	4	250	TBD	Call TI	Call TI			Samples
LMV1012XP-25/NOPB	ACTIVE	DSBGA	YPE	4	250	TBD	Call TI	Call TI			Samples
LMV1012XPX-15/NOPB	ACTIVE	DSBGA	YPE	4	3000	TBD	Call TI	Call TI	-40 to 85		Samples
LMV1012XPX-25/NOPB	ACTIVE	DSBGA	YPE	4	3000	TBD	Call TI	Call TI	-40 to 85		Samples

(1) The marketing status values are defined as follows:

ACTIVE: Product device recommended for new designs.

LIFEBUY: TI has announced that the device will be discontinued, and a lifetime-buy period is in effect.

NRND: Not recommended for new designs. Device is in production to support existing customers, but TI does not recommend using this part in a new design.

PREVIEW: Device has been announced but is not in production. Samples may or may not be available.

OBSOLETE: TI has discontinued the production of the device.

⁽²⁾ Eco Plan - The planned eco-friendly classification: Pb-Free (RoHS), Pb-Free (RoHS Exempt), or Green (RoHS & no Sb/Br) - please check <http://www.ti.com/productcontent> for the latest availability information and additional product content details.

TBD: The Pb-Free/Green conversion plan has not been defined.

Pb-Free (RoHS): TI's terms "Lead-Free" or "Pb-Free" mean semiconductor products that are compatible with the current RoHS requirements for all 6 substances, including the requirement that lead not exceed 0.1% by weight in homogeneous materials. Where designed to be soldered at high temperatures, TI Pb-Free products are suitable for use in specified lead-free processes.

Pb-Free (RoHS Exempt): This component has a RoHS exemption for either 1) lead-based flip-chip solder bumps used between the die and package, or 2) lead-based die adhesive used between the die and leadframe. The component is otherwise considered Pb-Free (RoHS compatible) as defined above.

Green (RoHS & no Sb/Br): TI defines "Green" to mean Pb-Free (RoHS compatible), and free of Bromine (Br) and Antimony (Sb) based flame retardants (Br or Sb do not exceed 0.1% by weight in homogeneous material)

⁽³⁾ MSL, Peak Temp. -- The Moisture Sensitivity Level rating according to the JEDEC industry standard classifications, and peak solder temperature.

⁽⁴⁾ Multiple Top-Side Markings will be inside parentheses. Only one Top-Side Marking contained in parentheses and separated by a "~" will appear on a device. If a line is indented then it is a continuation of the previous line and the two combined represent the entire Top-Side Marking for that device.

Important Information and Disclaimer: The information provided on this page represents TI's knowledge and belief as of the date that it is provided. TI bases its knowledge and belief on information provided by third parties, and makes no representation or warranty as to the accuracy of such information. Efforts are underway to better integrate information from third parties. TI has taken and continues to take reasonable steps to provide representative and accurate information but may not have conducted destructive testing or chemical analysis on incoming materials and chemicals. TI and TI suppliers consider certain information to be proprietary, and thus CAS numbers and other limited information may not be available for release.

In no event shall TI's liability arising out of such information exceed the total purchase price of the TI part(s) at issue in this document sold by TI to Customer on an annual basis.

YPB0004

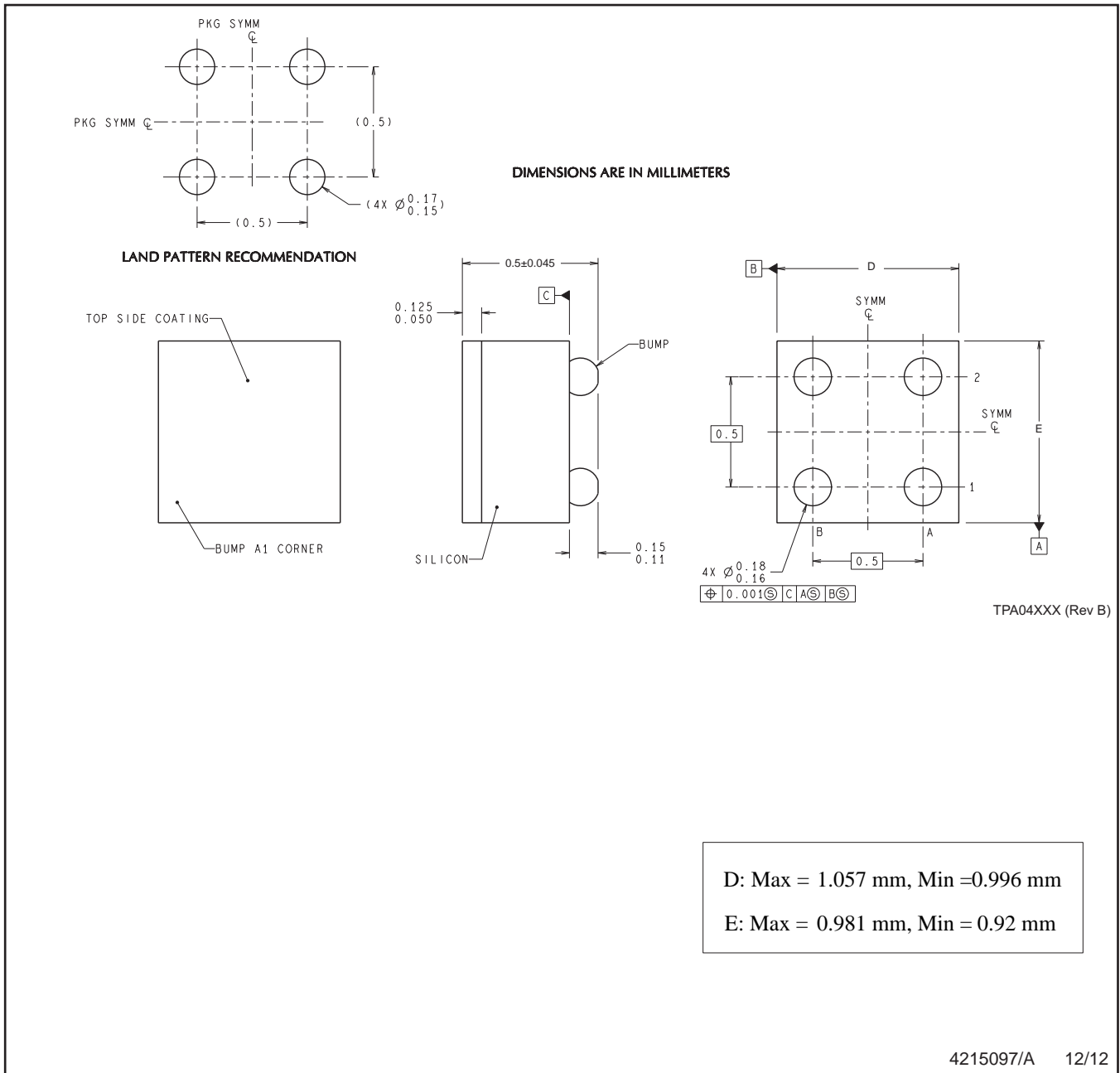

NOTES: A. All linear dimensions are in millimeters. Dimensioning and tolerancing per ASME Y14.5M-1994.
 B. This drawing is subject to change without notice.

YPC0004

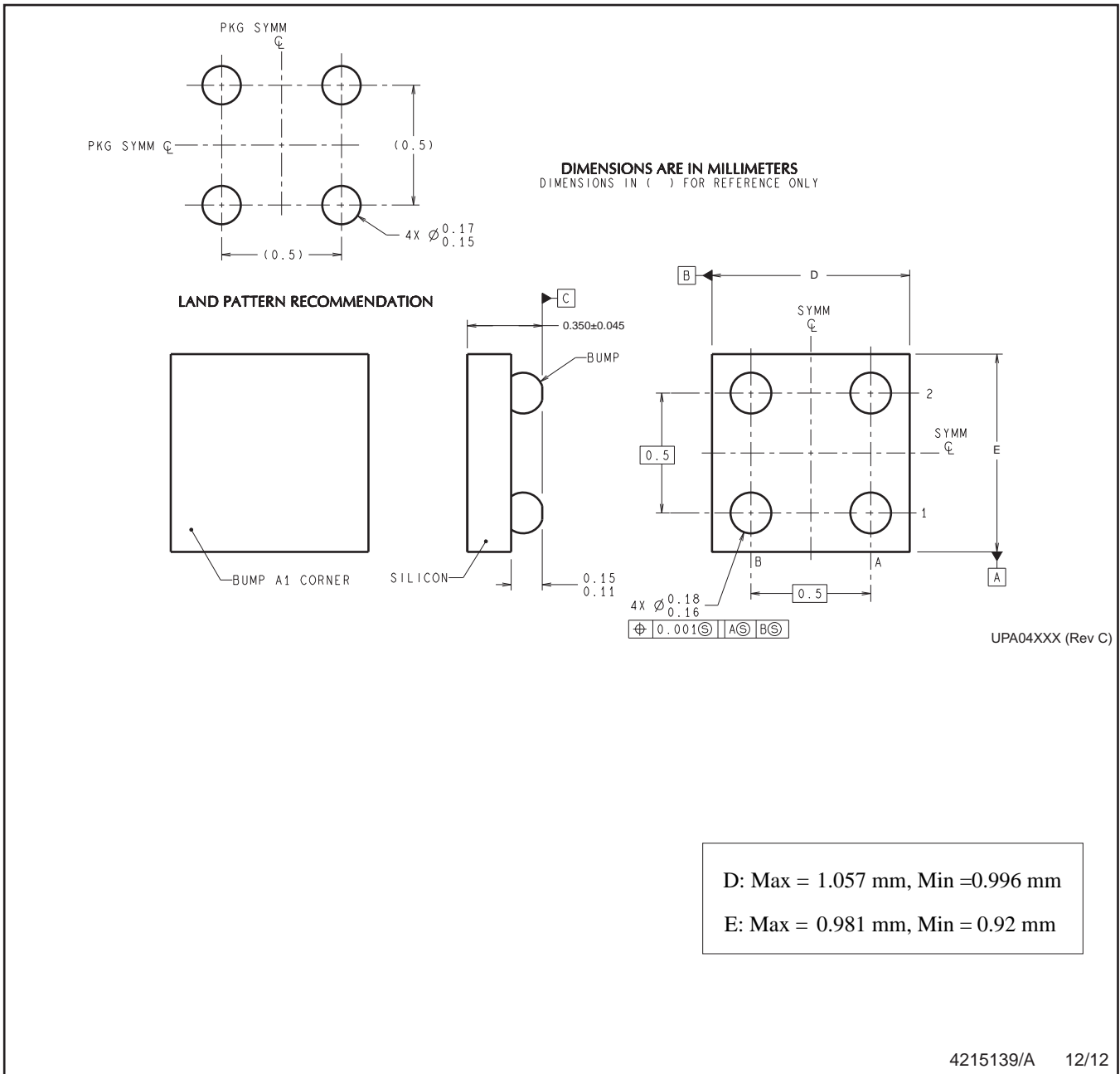

NOTES: A. All linear dimensions are in millimeters. Dimensioning and tolerancing per ASME Y14.5M-1994.
B. This drawing is subject to change without notice.

YPE0004

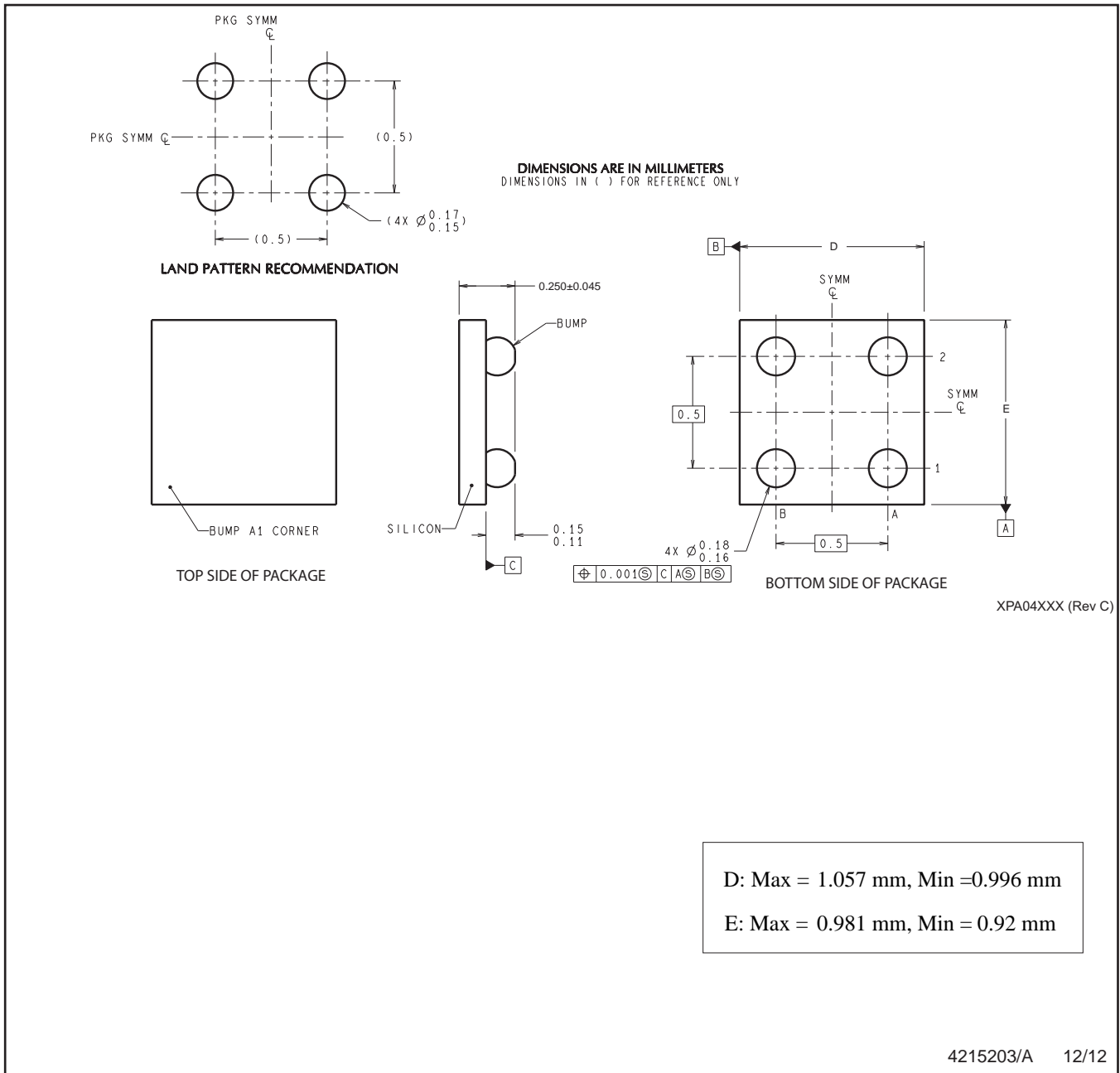

D: Max = 1.057 mm, Min = 0.996 mm
E: Max = 0.981 mm, Min = 0.92 mm

4215203/A 12/12

NOTES: A. All linear dimensions are in millimeters. Dimensioning and tolerancing per ASME Y14.5M-1994.
B. This drawing is subject to change without notice.

IMPORTANT NOTICE

Texas Instruments Incorporated and its subsidiaries (TI) reserve the right to make corrections, enhancements, improvements and other changes to its semiconductor products and services per JESD46, latest issue, and to discontinue any product or service per JESD48, latest issue. Buyers should obtain the latest relevant information before placing orders and should verify that such information is current and complete. All semiconductor products (also referred to herein as "components") are sold subject to TI's terms and conditions of sale supplied at the time of order acknowledgment.

TI warrants performance of its components to the specifications applicable at the time of sale, in accordance with the warranty in TI's terms and conditions of sale of semiconductor products. Testing and other quality control techniques are used to the extent TI deems necessary to support this warranty. Except where mandated by applicable law, testing of all parameters of each component is not necessarily performed.

TI assumes no liability for applications assistance or the design of Buyers' products. Buyers are responsible for their products and applications using TI components. To minimize the risks associated with Buyers' products and applications, Buyers should provide adequate design and operating safeguards.

TI does not warrant or represent that any license, either express or implied, is granted under any patent right, copyright, mask work right, or other intellectual property right relating to any combination, machine, or process in which TI components or services are used. Information published by TI regarding third-party products or services does not constitute a license to use such products or services or a warranty or endorsement thereof. Use of such information may require a license from a third party under the patents or other intellectual property of the third party, or a license from TI under the patents or other intellectual property of TI.

Reproduction of significant portions of TI information in TI data books or data sheets is permissible only if reproduction is without alteration and is accompanied by all associated warranties, conditions, limitations, and notices. TI is not responsible or liable for such altered documentation. Information of third parties may be subject to additional restrictions.

Resale of TI components or services with statements different from or beyond the parameters stated by TI for that component or service voids all express and any implied warranties for the associated TI component or service and is an unfair and deceptive business practice. TI is not responsible or liable for any such statements.

Buyer acknowledges and agrees that it is solely responsible for compliance with all legal, regulatory and safety-related requirements concerning its products, and any use of TI components in its applications, notwithstanding any applications-related information or support that may be provided by TI. Buyer represents and agrees that it has all the necessary expertise to create and implement safeguards which anticipate dangerous consequences of failures, monitor failures and their consequences, lessen the likelihood of failures that might cause harm and take appropriate remedial actions. Buyer will fully indemnify TI and its representatives against any damages arising out of the use of any TI components in safety-critical applications.

In some cases, TI components may be promoted specifically to facilitate safety-related applications. With such components, TI's goal is to help enable customers to design and create their own end-product solutions that meet applicable functional safety standards and requirements. Nonetheless, such components are subject to these terms.

No TI components are authorized for use in FDA Class III (or similar life-critical medical equipment) unless authorized officers of the parties have executed a special agreement specifically governing such use.

Only those TI components which TI has specifically designated as military grade or "enhanced plastic" are designed and intended for use in military/aerospace applications or environments. Buyer acknowledges and agrees that any military or aerospace use of TI components which have **not** been so designated is solely at the Buyer's risk, and that Buyer is solely responsible for compliance with all legal and regulatory requirements in connection with such use.

TI has specifically designated certain components as meeting ISO/TS16949 requirements, mainly for automotive use. In any case of use of non-designated products, TI will not be responsible for any failure to meet ISO/TS16949.

Products

Audio	www.ti.com/audio
Amplifiers	amplifier.ti.com
Data Converters	dataconverter.ti.com
DLP® Products	www.dlp.com
DSP	dsp.ti.com
Clocks and Timers	www.ti.com/clocks
Interface	interface.ti.com
Logic	logic.ti.com
Power Mgmt	power.ti.com
Microcontrollers	microcontroller.ti.com
RFID	www.ti-rfid.com
OMAP Applications Processors	www.ti.com/omap
Wireless Connectivity	www.ti.com/wirelessconnectivity

Applications

Automotive and Transportation	www.ti.com/automotive
Communications and Telecom	www.ti.com/communications
Computers and Peripherals	www.ti.com/computers
Consumer Electronics	www.ti.com/consumer-apps
Energy and Lighting	www.ti.com/energy
Industrial	www.ti.com/industrial
Medical	www.ti.com/medical
Security	www.ti.com/security
Space, Avionics and Defense	www.ti.com/space-avionics-defense
Video and Imaging	www.ti.com/video

TI E2E Community

e2e.ti.com