

阅读申明

- 1.本站收集的数据手册和产品资料都来自互联网，版权归原作者所有。如读者和版权方有任何异议请及时告之，我们将妥善解决。
- 2.本站提供的中文数据手册是英文数据手册的中文翻译，其目的是协助用户阅读，该译文无法自动跟随原稿更新，同时也可能存在翻译上的不当。建议读者以英文原稿为参考以便获得更精准的信息。
- 3.本站提供的产品资料，来自厂商的技术支持或者使用者的心得体会等，其内容可能存在描述上的差异，建议读者做出适当判断。
- 4.如需与我们联系，请发邮件到marketing@iczoom.com，主题请标有“数据手册”字样。

Read Statement

1. The datasheets and other product information on the site are all from network reference or other public materials, and the copyright belongs to the original author and original published source. If readers and copyright owners have any objections, please contact us and we will deal with it in a timely manner.
2. The Chinese datasheets provided on the website is a Chinese translation of the English datasheets. Its purpose is for reader's learning exchange only and do not involve commercial purposes. The translation cannot be automatically updated with the original manuscript, and there may also be improper translations. Readers are advised to use the English manuscript as a reference for more accurate information.
3. All product information provided on the website refer to solutions from manufacturers' technical support or users the contents may have differences in description, and readers are advised to take the original article as the standard.
4. If you have any questions, please contact us at marketing@iczoom.com and mark the subject with "Datasheets" .

AN7522

Dual 3-W BTL audio power amplifier

■ Overview

AN7522 is an audio power amplifier IC for the stereo system. In the BTL (balanced transformerless) method, fewer external parts and easier design for applications are required.

■ Features

- 3-W output (8 Ω) with supply voltage of 8 V
- On-chip standby function
- On-chip volume function

■ Applications

- Televisions, audio equipment, personal computers, and active speakers

■ Package

- HSIP012-P-0000E

■ Block Diagram

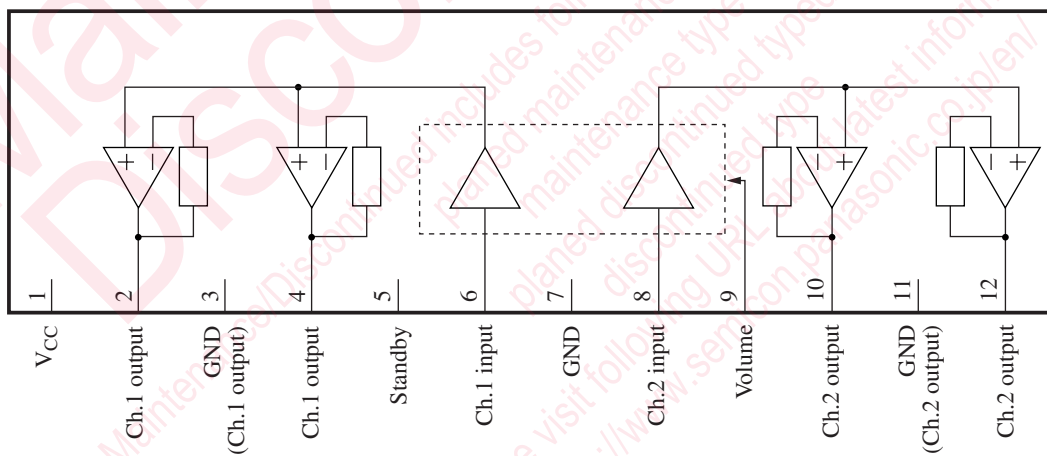

Pin Descriptions

Pin No.	Descriptions	Pin No.	Descriptions
1	Supply voltage	7	Ground (input)
2	Ch.1 + output	8	Ch.2 input
3	Ground (output ch.1)	9	Volume (max. volume if this pin is open.)
4	Ch.1 – output	10	Ch.2 – output
5	Standby (standby state if this pin is open.)	11	Ground (output ch.2)
6	Ch.1 input	12	Ch.2 + output

Absolute Maximum Ratings

Parameter	Symbol	Rating	Unit
Supply voltage *2	V_{CC}	14	V
Supply current	I_{CC}	2.0	A
Power dissipation *3	P_D	1.92	W
Operating ambient temperature *1	T_{opr}	-25 to +70	°C
Storage temperature *1	T_{stg}	-55 to +150	°C

Note) *1: Except for the operating ambient temperature and storage temperature, all ratings are for $T_a = 25^\circ\text{C}$.

*2: At no signal.

*3: The power dissipation shown is the value for $T_a = 70^\circ\text{C}$.

Recommended Operating Range

Parameter	Symbol	Range	Unit
Supply voltage	V_{CC}	3.5 to 13.5	V

Electrical Characteristics at $V_{CC} = 8.0\text{ V}$, $R_L = 8\ \Omega$, $f = 1\text{ kHz}$, $T_a = 25^\circ\text{C} \pm 2^\circ\text{C}$

Parameter	Symbol	Conditions	Min	Typ	Max	Unit
Quiescent circuit current	I_{CQ}	$V_{IN} = 0\text{ mV}$, Vol. = 0 V	—	45	100	mA
Standby current	I_{STB}	$V_{IN} = 0\text{ mV}$, Vol. = 0 V	—	1	10	μA
Output noise voltage *	V_{NO}	$R_g = 10\text{ k}\Omega$, Vol. = 0 V	—	0.10	0.4	mV[rms]
Voltage gain	G_V	$P_O = 0.5\text{ W}$, Vol. = 1.25 V	31	33	35	dB
Total harmonic distortion	THD	$P_O = 0.5\text{ W}$, Vol. = 1.25 V	—	0.10	0.5	%
Maximum output power	P_{O1}	THD = 10%, Vol. = 1.25 V	2.4	3.0	—	W
Ripple rejection ratio *	RR	$R_g = 10\text{ k}\Omega$, Vol. = 0 V, $V_R = 1\text{ V[rms]}$, $f_R = 120\text{ Hz}$	30	50	—	dB
Output offset voltage	V_{OFF}	$R_g = 10\text{ k}\Omega$, Vol. = 0 V	-250	0	250	mV
Volume attenuation rate *	Att	$P_O = 0.5\text{ W}$, Vol. = 0 V	70	85	—	dB
Channel balance 1	CB1	$P_O = 0.5\text{ W}$, Vol. = 1.25 V	-1	0	1	dB
Channel balance 2	CB2	$P_O = 0.5\text{ W}$, Vol. = 0.6 V	-3	0	3	dB
Intermediate voltage gain	G_{VM}	$P_O = 0.5\text{ W}$, Vol. = 0.6 V	20.5	23.5	26.5	dB
Channel crosstalk	CT	$P_O = 0.5\text{ W}$, Vol. = 1.25 V	40	55	—	dB

Note) *: In measuring, the filter for the range of 15 Hz to 30 kHz (12 dB/OCT) is used.

■ Terminal Equivalent Circuits at $V_{CC} = 8\text{ V}$

Pin No.	Pin name	Equivalent circuit	Voltage
1	V_{CC}	—	8 V
2	Ch.1 + output pin		3.6 V (at no signal)
3	GND		0 V
4	Ch.1 - output pin		3.6 V (at no signal)
5	Standby pin		0 V or 5 V (Standby off at supply 5 V. Standby at 0.4 V less or open.)

■ Terminal Equivalent Circuits at $V_{CC} = 8\text{ V}$ (continued)

Pin No.	Pin name	Equivalent circuit	Voltage
6	Ch.1 input pin		1.4 V (Input circuit bias voltage is output.)
7	GND		0 V
8	Ch.2 input pin		1.4 V (Input circuit bias voltage is output.)
9	Volume pin		Supply to 0 V to 1.25 V

■ Terminal Equivalent Circuits at $V_{CC} = 8\text{ V}$ (continued)

Pin No.	Pin name	Equivalent circuit	Voltage
10	Ch.2 – output pin		3.6 V (at no signal)
11	GND		0 V
12	Ch.2 + output pin		3.6 V (at no signal)

■ Usage Notes

- Please avoid the short-circuits to V_{CC} , ground, or load short-circuit.
- Please connect the cooling fin with the GND potential.
- The thermal shutdown circuit operates at about $T_j = 150^\circ\text{C}$. However, the thermal shutdown circuit is reset automatically if the temperature drops.
- Please carefully design the heat radiation especially when you take out high power at high V_{CC} .
- Please connect only the ground of signal with the signal GND of the amplifier in the previous stage.

■ Technical Data

- $P_D - T_a$ curves of HSIP012-P-0000A

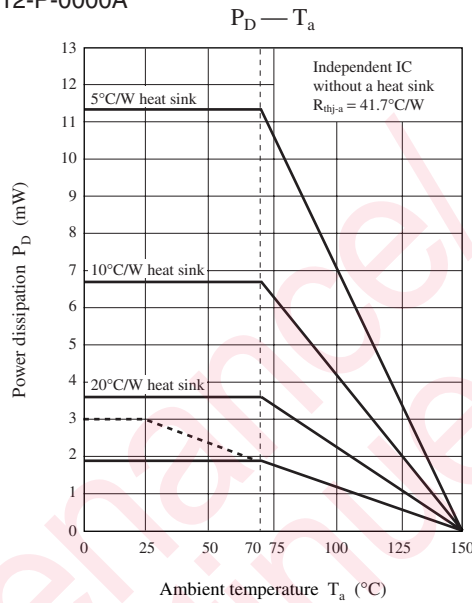

- Main characteristics

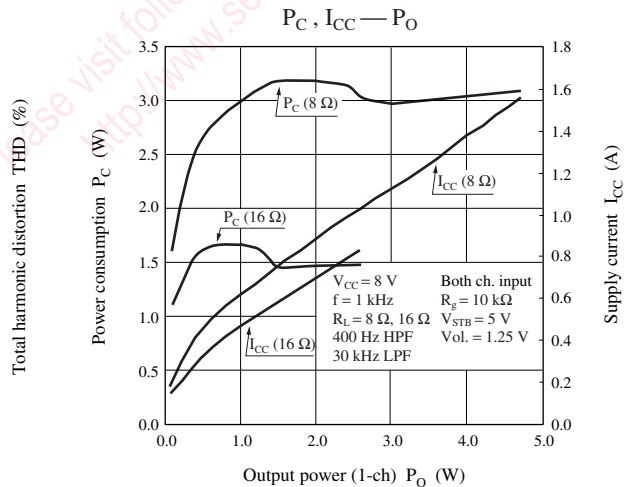
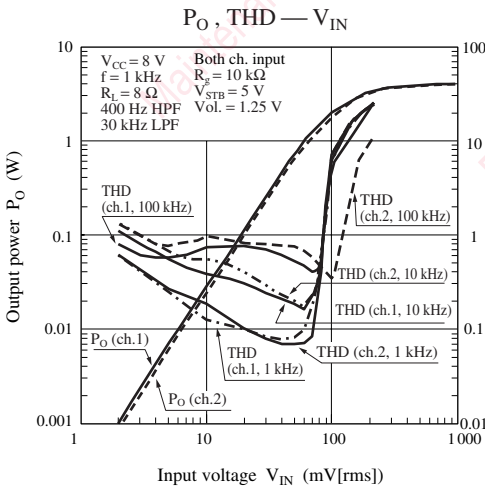
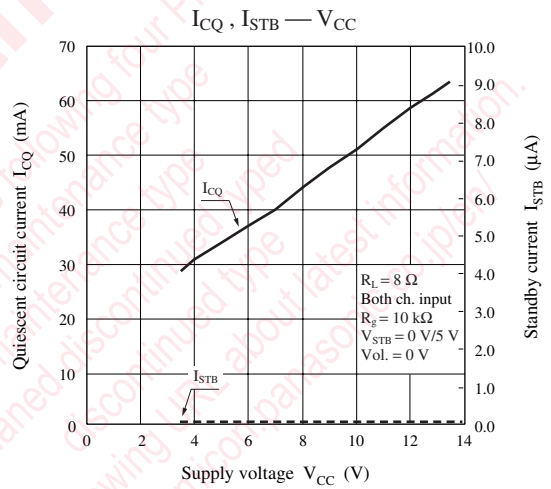
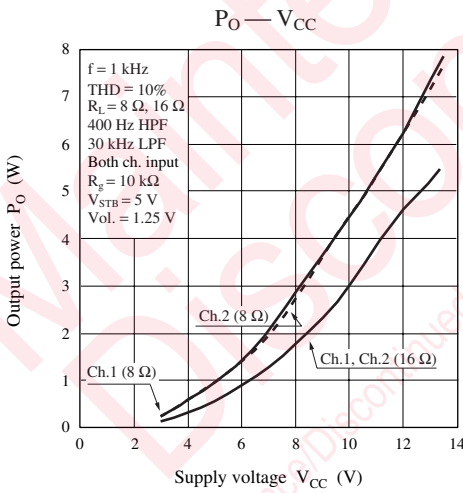

■ Technical Data (continued)
 • Main characteristics (continued)

$G_V, P_O - f$

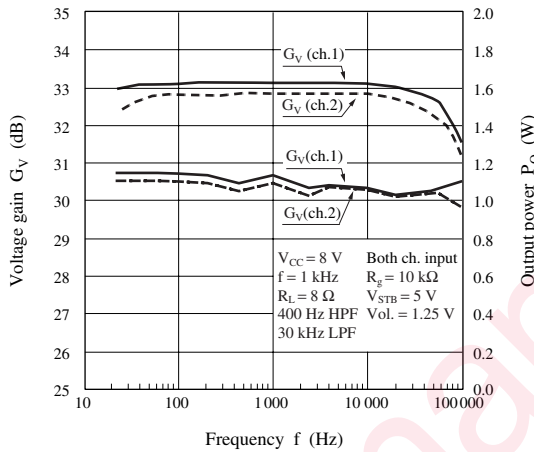

THD — f

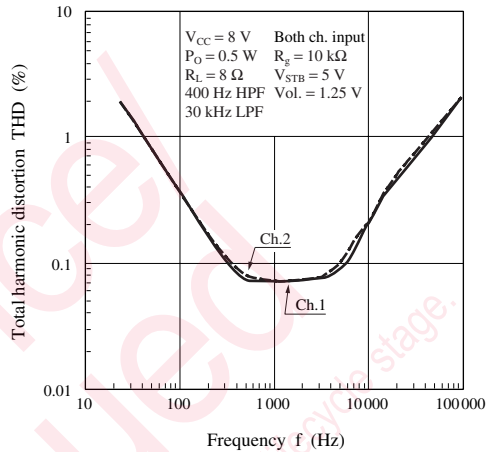

$G_V, \text{THD} - V_{CC}$

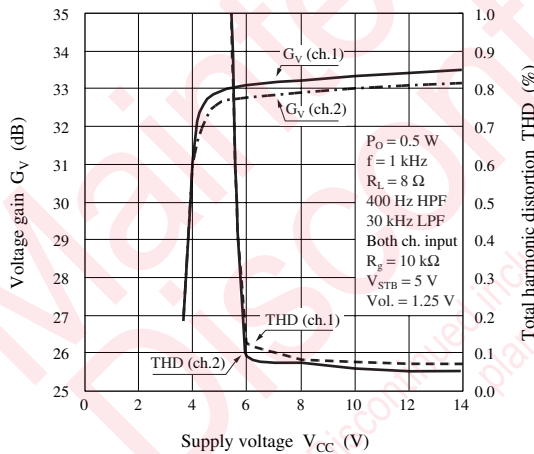

RR — V_{CC}

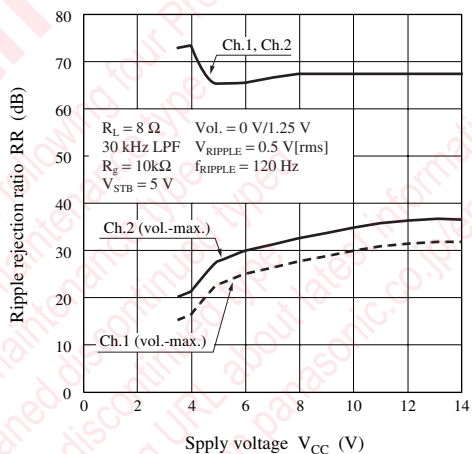

RR — V_{RIPPLE}

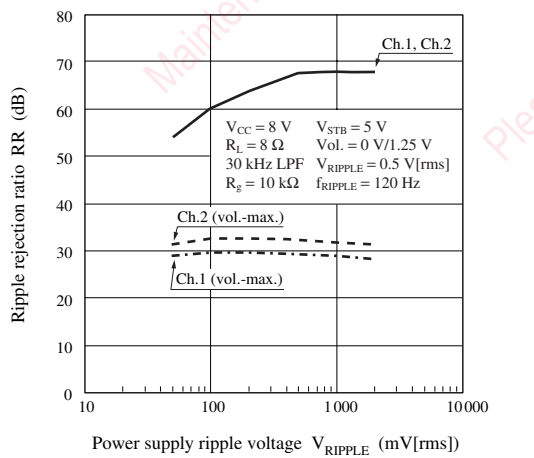

RR — f_{RIPPLE}

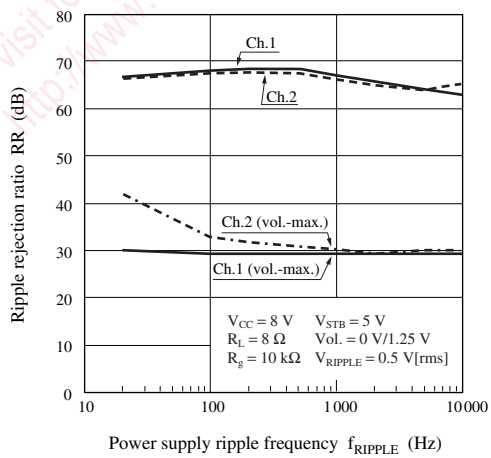

■ Technical Data (continued)

• Main characteristics (continued)

RR — Vol.

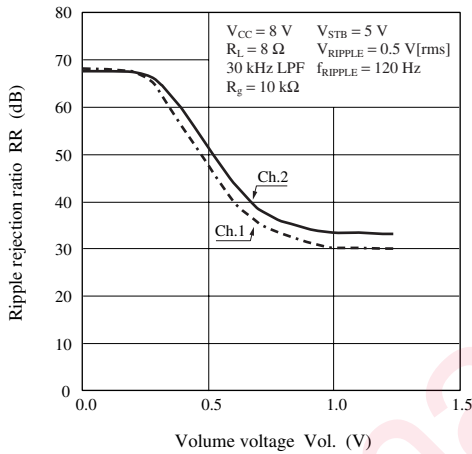

CT — V_{CC}

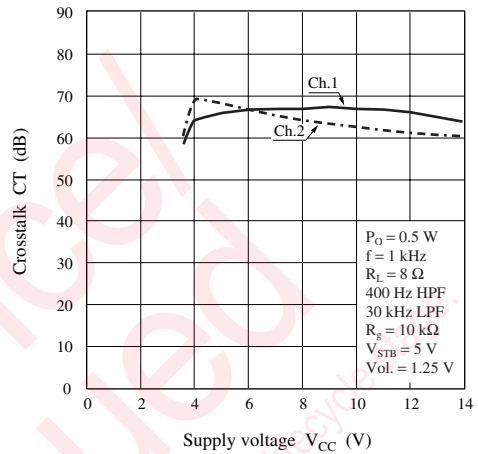

CT — V_{IN}

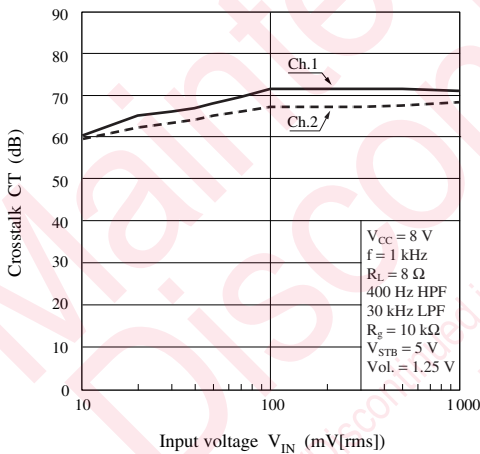

CT — f

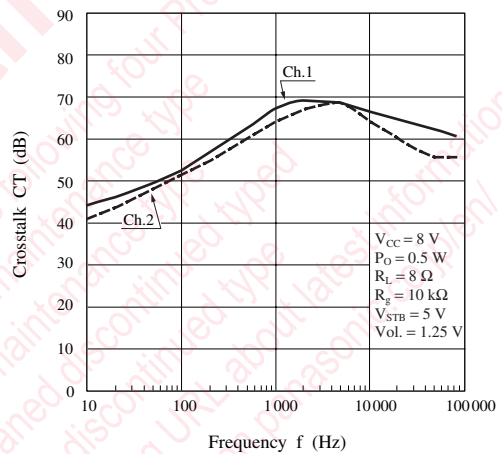

V_{NO} — V_{CC}

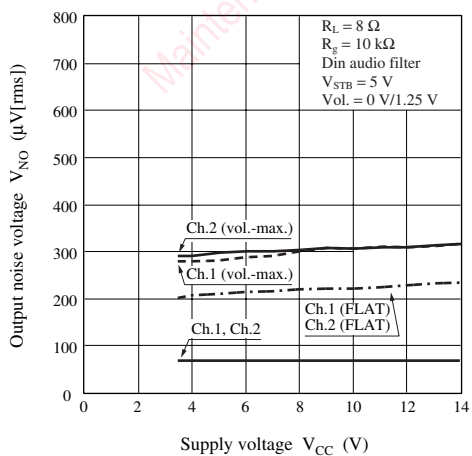

V_{NO} — R_g

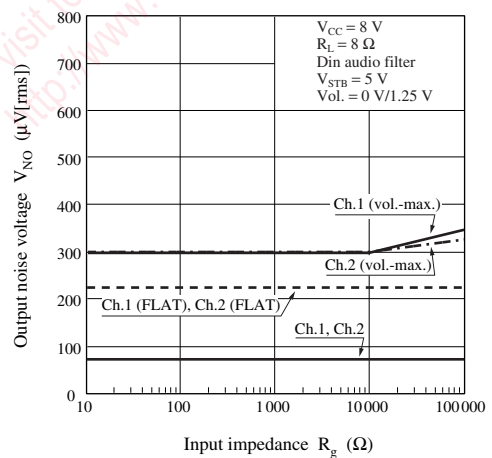

■ Technical Data (continued)

● Main characteristics (continued)

$V_{NO} - Vol.$

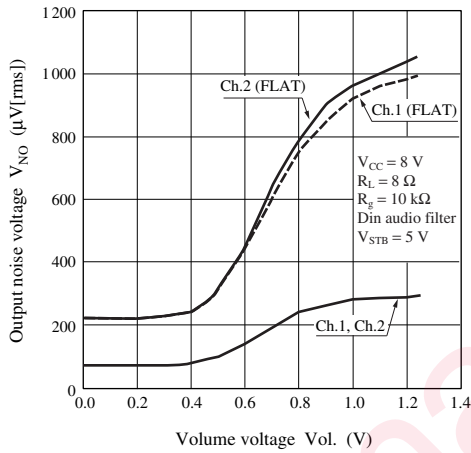

$I_{CQ} - V_{STB}$

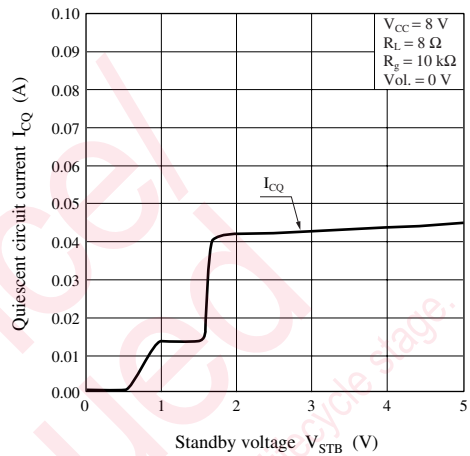

$Att - V_{CC}$

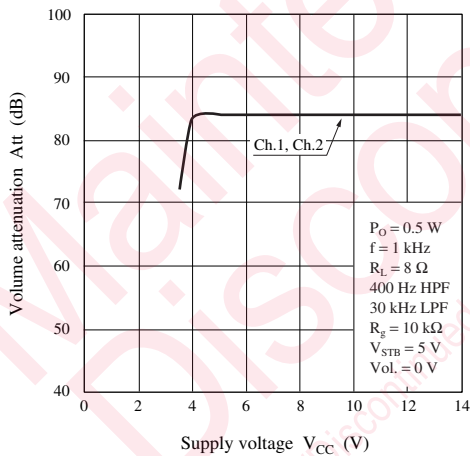

$Att - V_{IN}$

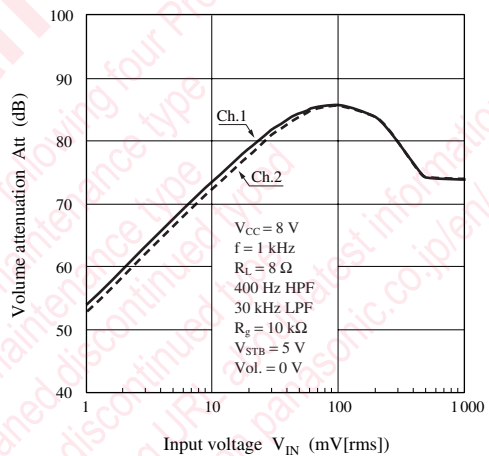

$Att - f$

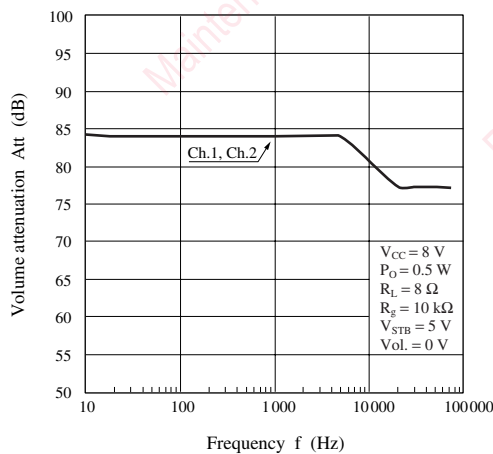

$Att - Vol.$

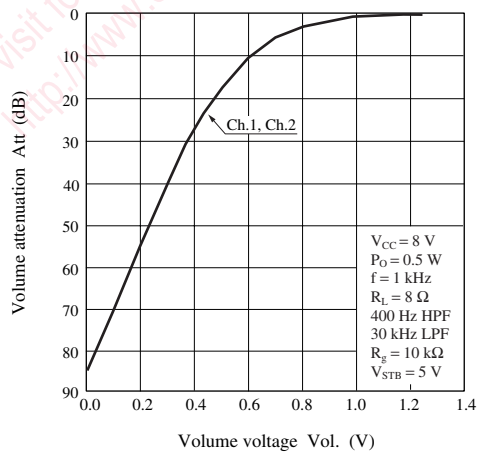

■ Technical Data (continued)

- Main characteristics (continued)

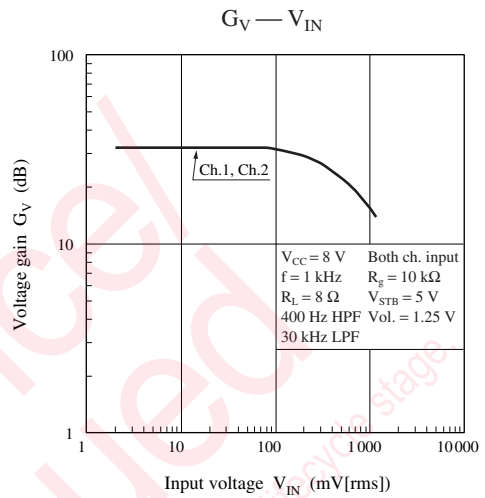
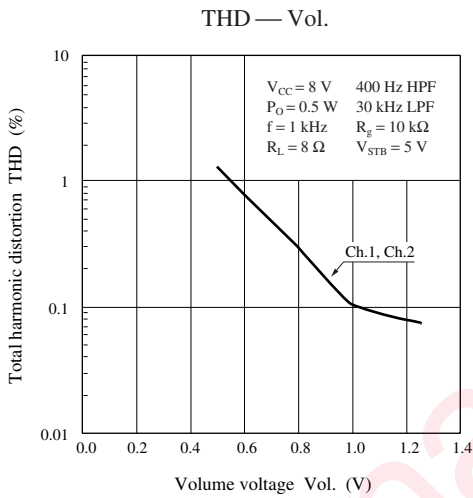

- Example of PCB pattern

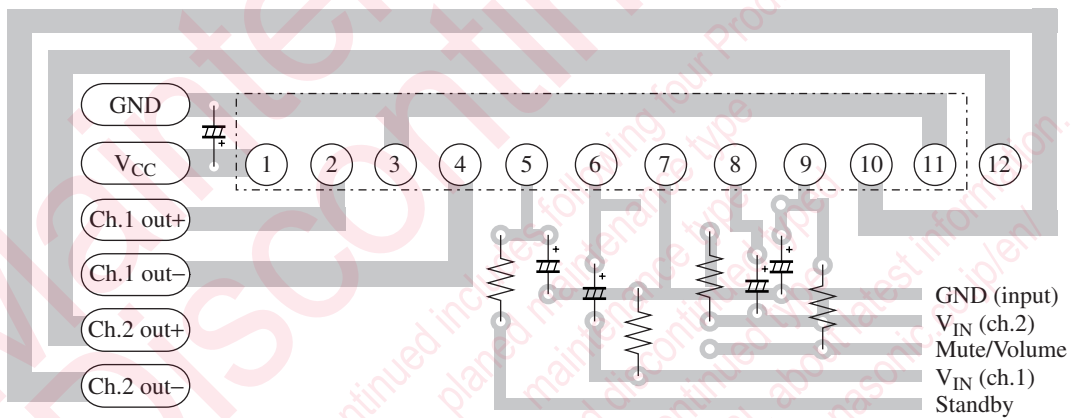

■ Application Circuit Example

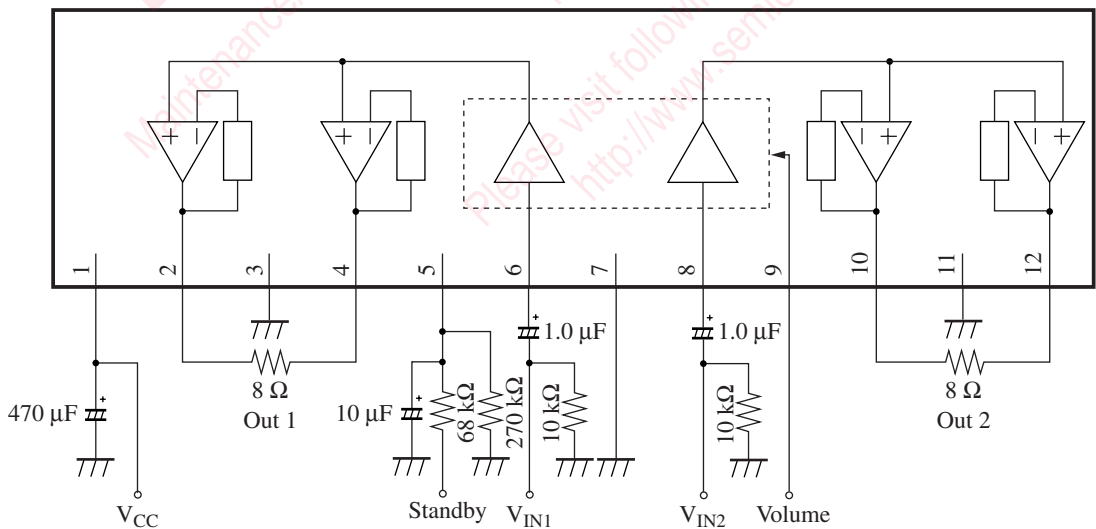

Request for your special attention and precautions in using the technical information and semiconductors described in this book

- (1) If any of the products or technical information described in this book is to be exported or provided to non-residents, the laws and regulations of the exporting country, especially, those with regard to security export control, must be observed.
- (2) The technical information described in this book is intended only to show the main characteristics and application circuit examples of the products, and no license is granted under any intellectual property right or other right owned by our company or any other company. Therefore, no responsibility is assumed by our company as to the infringement upon any such right owned by any other company which may arise as a result of the use of technical information described in this book.
- (3) The products described in this book are intended to be used for standard applications or general electronic equipment (such as office equipment, communications equipment, measuring instruments and household appliances).
Consult our sales staff in advance for information on the following applications:
 - Special applications (such as for airplanes, aerospace, automobiles, traffic control equipment, combustion equipment, life support systems and safety devices) in which exceptional quality and reliability are required, or if the failure or malfunction of the products may directly jeopardize life or harm the human body.
 - Any applications other than the standard applications intended.
- (4) The products and product specifications described in this book are subject to change without notice for modification and/or improvement. At the final stage of your design, purchasing, or use of the products, therefore, ask for the most up-to-date Product Standards in advance to make sure that the latest specifications satisfy your requirements.
- (5) When designing your equipment, comply with the range of absolute maximum rating and the guaranteed operating conditions (operating power supply voltage and operating environment etc.). Especially, please be careful not to exceed the range of absolute maximum rating on the transient state, such as power-on, power-off and mode-switching. Otherwise, we will not be liable for any defect which may arise later in your equipment.
 - Even when the products are used within the guaranteed values, take into the consideration of incidence of break down and failure mode, possible to occur to semiconductor products. Measures on the systems such as redundant design, arresting the spread of fire or preventing glitch are recommended in order to prevent physical injury, fire, social damages, for example, by using the products.
- (6) Comply with the instructions for use in order to prevent breakdown and characteristics change due to external factors (ESD, EOS, thermal stress and mechanical stress) at the time of handling, mounting or at customer's process. When using products for which damp-proof packing is required, satisfy the conditions, such as shelf life and the elapsed time since first opening the packages.
- (7) This book may be not reprinted or reproduced whether wholly or partially, without the prior written permission of Matsushita Electric Industrial Co., Ltd.