

阅读申明

- 1.本站收集的数据手册和产品资料都来自互联网，版权归原作者所有。如读者和版权方有任何异议请及时告之，我们将妥善解决。
- 2.本站提供的中文数据手册是英文数据手册的中文翻译，其目的是协助用户阅读，该译文无法自动跟随原稿更新，同时也可能存在翻译上的不当。建议读者以英文原稿为参考以便获得更精准的信息。
- 3.本站提供的产品资料，来自厂商的技术支持或者使用者的心得体会等，其内容可能存在描述上的差异，建议读者做出适当判断。
- 4.如需与我们联系，请发邮件到marketing@iczoom.com，主题请标有“数据手册”字样。

Read Statement

1. The datasheets and other product information on the site are all from network reference or other public materials, and the copyright belongs to the original author and original published source. If readers and copyright owners have any objections, please contact us and we will deal with it in a timely manner.
2. The Chinese datasheets provided on the website is a Chinese translation of the English datasheets. Its purpose is for reader's learning exchange only and do not involve commercial purposes. The translation cannot be automatically updated with the original manuscript, and there may also be improper translations. Readers are advised to use the English manuscript as a reference for more accurate information.
3. All product information provided on the website refer to solutions from manufacturers' technical support or users the contents may have differences in description, and readers are advised to take the original article as the standard.
4. If you have any questions, please contact us at marketing@iczoom.com and mark the subject with "Datasheets" .

LM4844 Boomer™ Audio Power Amplifier Series Stereo 1.2W Audio Sub-System with 3D Enhancement

Check for Samples: [LM4844](#)

FEATURES

- Stereo Speaker Amplifier
- Stereo OCL Headphone Amplifier
- Independent Left, Right, and Mono Volume Controls
- Texas Instruments 3D Enhancement
- I²C Compatible Interface
- Ultra Low Shutdown Current
- Click and Pop Suppression Circuit
- 10 Distinct Output Modes

APPLICATIONS

- Cell Phones
- PDAs
- Portable Gaming Devices
- Internet Appliances
- Portable DVD, CD, AAC, and MP3 Players

KEY SPECIFICATIONS

- P_{OUT}, Stereo BTL, 8Ω, 3.3V, 1% THD+N, 495mW (Typ)
- P_{OUT} HP, 32Ω, 3.3V, 1% THD+N, 33mW (Typ)
- Shutdown Current, 3.3V, 0.1μA (Typ)

DESCRIPTION

The LM4844 is an integrated audio sub-system designed for stereo cell phone applications. Operating on a 3.3V supply, it combines a stereo speaker amplifier delivering 495mW per channel into an 8Ω load and a stereo OCL headphone amplifier delivering 33mW per channel into a 32Ω load.

It integrates the audio amplifiers, volume control, mixer, power management control, and Texas Instruments 3D enhancement all into a single package. In addition, the LM4844 routes and mixes the stereo and mono inputs into 10 distinct output modes. The LM4844 is controlled through an I²C compatible interface.

Boomer audio power amplifiers are designed specifically to provide high quality output power with a minimal amount of external components.

The LM4844 is available in a very small 2.5mm x 2.9mm 30-bump DSBGA (YZR) package.



Please be aware that an important notice concerning availability, standard warranty, and use in critical applications of Texas Instruments semiconductor products and disclaimers thereto appears at the end of this data sheet.

Boomer is a trademark of Texas Instruments.

All other trademarks are the property of their respective owners.

Block Diagram

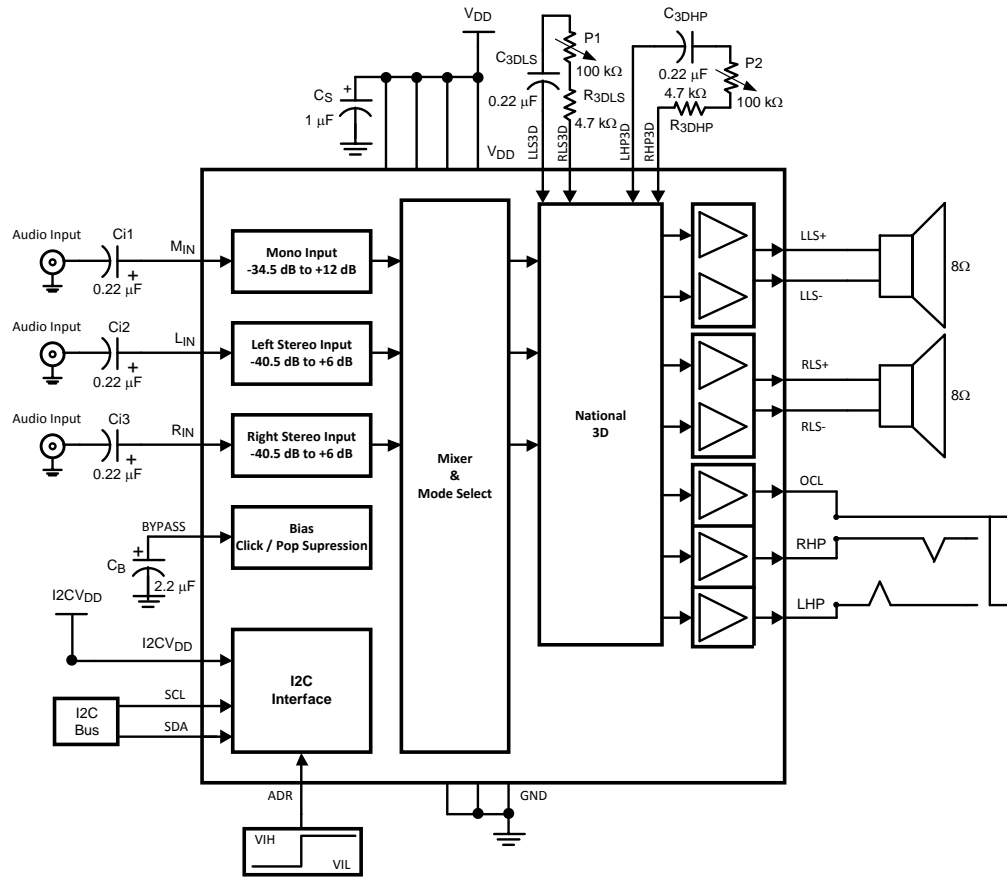

Figure 1. Audio Sub-System Block Diagram

Connection Diagram

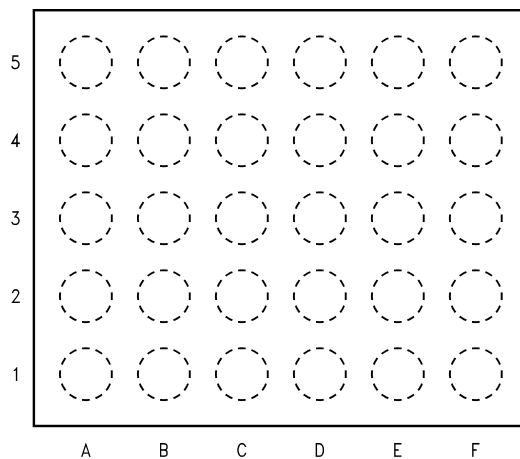

Figure 2. 30 Bump DSBGA (YZR) Package Top View
(Bump-side down)
See Package Number YZR0030

PIN CONNECTION (YZR)

Pin	Name	Pin Description
A1	RLS+	Right Loudspeaker Positive Output
A2	V _{DD}	Power Supply
A3	SDA	Data
A4	RHP3D	Right Headphone 3D
A5	RHP	Right Headphone Output
B1	GND	Ground
B2	I ² C V _{DD}	I ² C Interface Power Supply
B3	ADR	I ² C Address Select
B4	LHP3D	Left Headphone 3D
B5	V _{DD}	Power Supply
C1	RLS-	Right Loudspeaker Negative Output
C2	NC	No Connect
C3	SCL	Clock
C4	NC	No Connect
C5	GND	Ground
D1	LLS-	Left Loudspeaker Negative Output
D2	V _{DD}	Power Supply
D3	M _{IN}	Mono Input
D4	NC	No Connect
D5	OCL	V _{DD} /2 Supply for headphone jack's sleeve
E1	GND	Ground
E2	BYPASS	Half-supply bypass
E3	LLS3D	Left Loudspeaker 3D
E4	R _{IN}	Right Stereo Input
E5	NC	No Connect
F1	LLS+	Left Loudspeaker Positive Output
F2	V _{DD}	Power Supply
F3	RLS3D	Right Loudspeaker 3D
F4	L _{IN}	Left Stereo Input
F5	LHP	Left Headphone Output



These devices have limited built-in ESD protection. The leads should be shorted together or the device placed in conductive foam during storage or handling to prevent electrostatic damage to the MOS gates.

Absolute Maximum Ratings⁽¹⁾⁽²⁾⁽³⁾

Supply Voltage		6.0V
Storage Temperature		-65°C to +150°C
Input Voltage		-0.3V to V _{DD} + 0.3V
Power Dissipation ⁽⁴⁾		Internally Limited
ESD Susceptibility ⁽⁵⁾		2000V
ESD Susceptibility ⁽⁶⁾		200V
Junction Temperature (T _J)		150°C
Thermal Resistance	θ _{JA} (YZR0030)	62°C/W

- (1) All voltages are measured with respect to the GND pin unless otherwise specified.
- (2) Absolute Maximum Ratings indicate limits beyond which damage to the device may occur. Operating Ratings indicate conditions for which the device is functional but do not ensure specific performance limits. Electrical Characteristics state DC and AC electrical specifications under particular test conditions which ensure specific performance limits. This assumes that the device is within the Operating Ratings. Specifications are not ensured for parameters where no limit is given, however, the typical value is a good indication of device performance.
- (3) If Military/Aerospace specified devices are required, please contact the Texas Instruments Sales Office/Distributors for availability and specifications.
- (4) The maximum power dissipation must be derated at elevated temperatures and is dictated by T_{JMAX}, θ_{JA}, and the ambient temperature, T_A. The maximum allowable power dissipation is P_{DMAX} = (T_{JMAX} - T_A) / θ_{JA} or the number given in Absolute Maximum Ratings, whichever is lower. For the LM4844 typical application with V_{DD} = 3.3V and R_L = 8Ω stereo operation, the total power dissipation is TBDW. θ_{JA} = TBD°C/W.
- (5) Human body model, 100pF discharged through a 1.5kΩ resistor.
- (6) Machine Model, 220pF-240pF discharged through all pins.

Operating Ratings

Temperature Range	T _{MIN} ≤ T _A ≤ T _{MAX}	-40°C ≤ T _A ≤ +85°C
Supply Voltage (V _{DD})		2.7V ≤ V _{DD} ≤ 5.5V
Supply Voltage (I ² CV _{DD}) ⁽¹⁾		I ² CV _{DD} ≤ V _{DD}
		1.7V ≤ I ² CV _{DD} ≤ 5.5V

- (1) Refer to Control Interface Electrical Characteristics tables.

Audio Amplifier Electrical Characteristics $V_{DD} = 5.0V^{(1)(2)}$

 The following specifications apply for $V_{DD} = 5.0V$, unless otherwise specified. Limits apply for $T_A = 25^\circ C$.

Symbol	Parameter	Conditions	LM4844		Units (Limits)
			Typical ⁽³⁾	Limits ⁽⁴⁾⁽⁵⁾	
I_{DD}	Supply Current ⁽⁶⁾	$V_{IN} = 0V$, No load; $LD5 = RD5 = 0$			
		Mode 4, 9, 14	5	8	mA (max)
		Mode 2, 7, 12	12	18	mA (max)
		Mode 3, 8, 13	13	20	mA (max)
I_{SD}	Shutdown Current ⁽⁶⁾	Mode 0	0.2	2.5	μA (max)
P_O	Output Power	Speaker; THD+N = 1%; $f = 1kHz$; 8 Ω BTL	1.2	0.9	W (min)
		Headphone; THD+N = 1%; $f = 1kHz$; 32 Ω SE	80	60	mW (min)
THD+N	Total Harmonic Distortion Plus Noise	$LD5 = RD5 = 0$			
		Speaker; $P_O = 400mW$; $f = 1kHz$; 8 Ω BTL	0.05		%
		Headphone; $P_O = 15mW$; $f = 1kHz$; 32 Ω SE	0.06		%
V_{OS}	Offset Voltage	Speaker; $LD5 = RD5 = 0$	5	40	mV (max)
		Headphone; $LD5 = RD5 = 0$	2	30	mV (max)
N_{OUT}	Output Noise	A-weighted, 0dB gain; $LD5 = RD5 = 0$			
		Speaker; Mode 2, 3, 7, 8	31		μV
		Speaker; Mode 12, 13	35		μV
		Headphone; Mode 3, 4, 8, 9	12		μV
		Headphone; Mode 13, 14	14		μV
PSRR	Power Supply Rejection Ratio	$f = 217Hz$; $V_{rip} = 200mV_{pp}$; $C_B = 2.2\mu F$; 0dB Gain Setting; $LD5 = RD5 = 0$			
		Speaker; Mode 2, 3, 7, 8	71		dB
		Speaker; Mode 12, 13, Headphone; Mode 3, 4, 8, 9	65	55	dB (min)
		Headphone; Mode 13, 14	76	62	dB (min)
Xtalk	Crosstalk	$LD5 = RD5 = 0$			
		Loudspeaker; $P_O = 400mW$; $f = 1kHz$	84		dB
		Headphone; $P_O = 15mW$; $f = 1kHz$	60		dB
T_{WU}	Wake-up Time	$CD4 = 0$; $C_B = 2.2\mu F$	103		ms
		$CD4 = 1$; $C_B = 2.2\mu F$	42		ms

- (1) All voltages are measured with respect to the GND pin unless otherwise specified.
- (2) Absolute Maximum Ratings indicate limits beyond which damage to the device may occur. Operating Ratings indicate conditions for which the device is functional but do not ensure specific performance limits. Electrical Characteristics state DC and AC electrical specifications under particular test conditions which ensure specific performance limits. This assumes that the device is within the Operating Ratings. Specifications are not ensured for parameters where no limit is given, however, the typical value is a good indication of device performance.
- (3) Typicals are measured at $+25^\circ C$ and represent the parametric norm.
- (4) Limits are specified to Texas Instruments' AOQL (Average Outgoing Quality Level).
- (5) Datasheet min/max specification limits are specified by design, test, or statistical analysis.
- (6) Shutdown current and supply current are measured in a normal room environment.

Audio Amplifier Electrical Characteristics $V_{DD} = 3.0V^{(1)(2)}$

The following specifications apply for $V_{DD} = 3.0V$, unless otherwise specified. Limits apply for $T_A = 25^\circ C$.

Symbol	Parameter	Conditions	LM4844		Units (Limits)
			Typical ⁽³⁾	Limits ⁽⁴⁾⁽⁵⁾	
I_{DD}	Supply Current ⁽⁶⁾	$V_{IN} = 0V$, No load; $LD5 = RD5 = 0$			
		Mode 4, 9, 14	4.5	7.5	mA (max)
		Mode 2, 7, 12	10	16	mA (max)
		Mode 3, 8, 13	11	18	mA (max)
I_{SD}	Shutdown Current ⁽⁶⁾	Mode 0	0.1	2	μA (max)
P_O	Output Power	Speaker; THD+N = 1%; $f = 1kHz$; 4 Ω BTL	390	320	mW (min)
		Headphone; THD+N = 1%; $f = 1kHz$; 32 Ω SE	28	21	mW (min)
THD+N	Total Harmonic Distortion Plus Noise	$LD5 = RD5 = 0$			
		Speaker; $P_O = 200mW$; $f = 1kHz$; 8 Ω BTL	0.05		%
		Headphone; $P_O = 10mW$; $f = 1kHz$; 32 Ω SE	0.05		%
V_{OS}	Offset Voltage	Speaker; $LD5 = RD5 = 0$	5	40	mV (max)
		Headphone; $LD5 = RD5 = 0$	2	30	mV (max)
N_{OUT}	Output Noise	A-weighted; 0dB gain; $LD5 = RD5 = 0$			
		Speaker; Mode 2, 3, 7, 8	32		μV
		Speaker; Mode 12, 13	41		μV
		Headphone; Mode 3, 4, 8, 9	13		μV
		Headphone; Mode 13, 14	15		μV
PSRR	Power Supply Rejection Ratio	$f = 217Hz$, $V_{rip} = 200mV_{pp}$; $C_B = 2.2\mu F$; 0dB Gain Setting; $LD5 = RD5 = 0$			
		Speaker; Mode 2, 3, 7, 8	73		dB
		Speaker; Mode 12, 13,	66	55	dB (min)
		Headphone; Mode 3, 4, 8, 9	78		dB
		Headphone; Mode 13, 14	72	62	dB (min)
Xtalk	Crosstalk	$LD5 = RD5 = 0$			
		Loudspeaker; $P_O = 200mW$; $f = 1kHz$	85		dB
		Headphone; $P_O = 10mW$; $f = 1kHz$	60		dB
T_{WU}	Wake-up Time	$CD4 = 0$; $C_B = 2.2\mu F$	70		ms
		$CD4 = 1$; $C_B = 2.2\mu F$	30		ms

- (1) All voltages are measured with respect to the GND pin unless otherwise specified.
- (2) Absolute Maximum Ratings indicate limits beyond which damage to the device may occur. Operating Ratings indicate conditions for which the device is functional but do not ensure specific performance limits. Electrical Characteristics state DC and AC electrical specifications under particular test conditions which ensure specific performance limits. This assumes that the device is within the Operating Ratings. Specifications are not ensured for parameters where no limit is given, however, the typical value is a good indication of device performance.
- (3) Typicals are measured at $+25^\circ C$ and represent the parametric norm.
- (4) Limits are specified to Texas Instruments' AOQL (Average Outgoing Quality Level).
- (5) Datasheet min/max specification limits are specified by design, test, or statistical analysis.
- (6) Shutdown current and supply current are measured in a normal room environment.

Volume Control Electrical Characteristics⁽¹⁾⁽²⁾

The following specifications apply for $3V \leq V_{DD} \leq 5V$ and $3V \leq I^2CV_{DD} \leq 5V$, unless otherwise specified. Limits apply for $T_A = 25^\circ\text{C}$.

Symbol	Parameter	Conditions	LM4844		Units (Limits)
			Typical ⁽³⁾	Limits ⁽⁴⁾⁽⁵⁾	
	Stereo Volume Control Range	maximum gain setting	6	5.5 6.5	dB (min) dB (max)
		minimum gain setting	-40.5	-41 -40	dB (min) dB (max)
	Mono Volume Control Range	maximum gain setting	12	11.5 12.5	dB (min) dB (max)
		minimum gain setting	-34.5	-35 -34	dB (min) dB (max)
	Volume Control Step Size		1.5		dB
	Volume Control Step Size Error		+/-0.2	+/-0.5	dB (max)
	Stereo Channel to Channel Gain Mismatch		0.3		dB
	Mute Attenuation	Mode 12, $V_{in} = 1V_{RMS}$			
		Headphone	100		dB
	L_{IN} and R_{IN} Input Impedance	maximum gain setting	33	25 42	k Ω (min) k Ω (max)
		minimum gain setting	100	75 125	k Ω (min) k Ω (max)
	M_{IN} Input Impedance	maximum gain setting	20	15 25	k Ω (min) k Ω (max)
		minimum gain setting	96	73 123	k Ω (min) k Ω (max)

- (1) All voltages are measured with respect to the GND pin unless otherwise specified.
- (2) Absolute Maximum Ratings indicate limits beyond which damage to the device may occur. Operating Ratings indicate conditions for which the device is functional but do not ensure specific performance limits. Electrical Characteristics state DC and AC electrical specifications under particular test conditions which ensure specific performance limits. This assumes that the device is within the Operating Ratings. Specifications are not ensured for parameters where no limit is given, however, the typical value is a good indication of device performance.
- (3) Typical values are measured at $+25^\circ\text{C}$ and represent the parametric norm.
- (4) Limits are specified to Texas Instruments' AOQL (Average Outgoing Quality Level).
- (5) Datasheet min/max specification limits are specified by design, test, or statistical analysis.

Control Interface Electrical Characteristics⁽¹⁾⁽²⁾

The following specifications apply for $V_{DD} = 5.0V$ and $3.0V$, $T_A = 25^\circ C$, $2.2V \leq I^2CV_{DD} \leq 5.5V$, unless otherwise specified.

Symbol	Parameter	Conditions	LM4844		Units (Limits)
			Typical ⁽³⁾	Limits ⁽¹⁾⁽⁴⁾⁽⁵⁾	
t_1	I ² C Clock Period			2.5	μs (min)
t_2	I ² C Data Setup Time			100	ns (min)
t_3	I ² C Data Stable Time			0	ns (min)
t_4	Start Condition Time			100	ns (min)
t_5	Stop Condition time			100	ns (min)
t_6	I ² C Data Hold Time			100	ns (min)
V_{IH}	I ² C Input Voltage High			$0.7 \times I^2CV_{DD}$	V (min)
V_{IL}	I ² C Input Voltage Low			$0.3 \times I^2CV_{DD}$	V (max)

- (1) All voltages are measured with respect to the GND pin unless otherwise specified.
- (2) Absolute Maximum Ratings indicate limits beyond which damage to the device may occur. Operating Ratings indicate conditions for which the device is functional but do not ensure specific performance limits. Electrical Characteristics state DC and AC electrical specifications under particular test conditions which ensure specific performance limits. This assumes that the device is within the Operating Ratings. Specifications are not ensured for parameters where no limit is given, however, the typical value is a good indication of device performance.
- (3) Typicals are measured at $+25^\circ C$ and represent the parametric norm.
- (4) Limits are specified to Texas Instruments' AOQL (Average Outgoing Quality Level).
- (5) Datasheet min/max specification limits are specified by design, test, or statistical analysis.

Control Interface Electrical Characteristics⁽¹⁾⁽²⁾

The following specifications apply for $V_{DD} = 5.0V$ and $3.0V$, $T_A = 25^\circ C$, $1.7V \leq I^2CV_{DD} \leq 2.2V$, unless otherwise specified.

Symbol	Parameter	Conditions	LM4844		Units (Limits)
			Typical ⁽³⁾	Limits ⁽¹⁾⁽⁴⁾⁽⁵⁾	
t_1	I ² C Clock Period			2.5	μs (min)
t_2	I ² C Data Setup Time			250	ns (min)
t_3	I ² C Data Stable Time			0	ns (min)
t_4	Start Condition Time			250	ns (min)
t_5	Stop Condition time			250	ns (min)
t_6	I ² C Data Hold Time			250	ns (min)
V_{IH}	I ² C Input Voltage High			$0.7 \times I^2CV_{DD}$	V (min)
V_{IL}	I ² C Input Voltage Low			$0.25 \times I^2CV_{DD}$	V (max)

- (1) All voltages are measured with respect to the GND pin unless otherwise specified.
- (2) Absolute Maximum Ratings indicate limits beyond which damage to the device may occur. Operating Ratings indicate conditions for which the device is functional but do not ensure specific performance limits. Electrical Characteristics state DC and AC electrical specifications under particular test conditions which ensure specific performance limits. This assumes that the device is within the Operating Ratings. Specifications are not ensured for parameters where no limit is given, however, the typical value is a good indication of device performance.
- (3) Typicals are measured at $+25^\circ C$ and represent the parametric norm.
- (4) Limits are specified to Texas Instruments' AOQL (Average Outgoing Quality Level).
- (5) Datasheet min/max specification limits are specified by design, test, or statistical analysis.

Typical Performance Characteristics

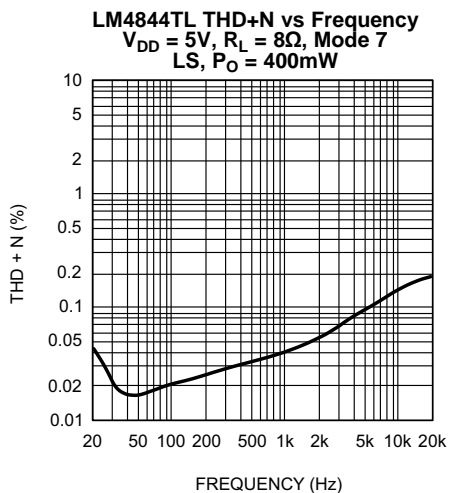

Figure 3.

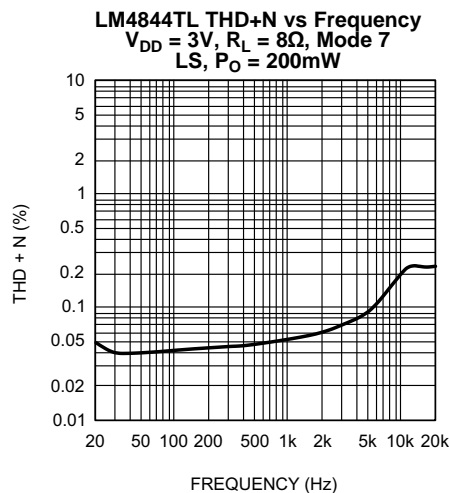

Figure 4.

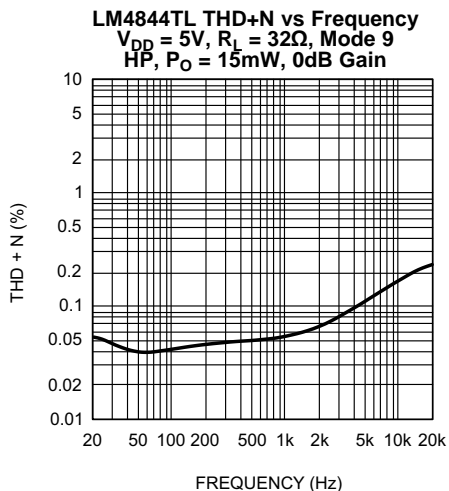

Figure 5.

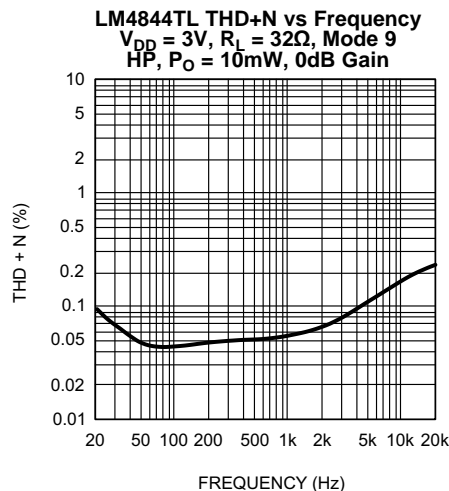

Figure 6.

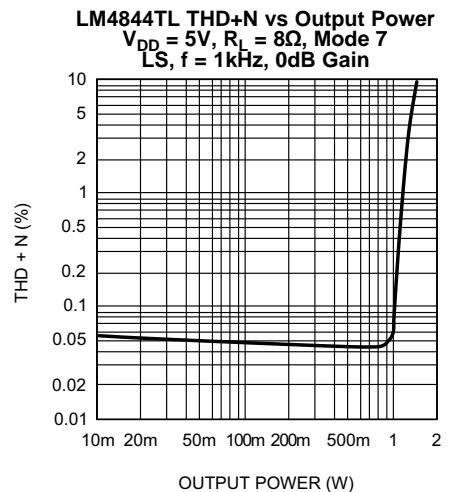

Figure 7.

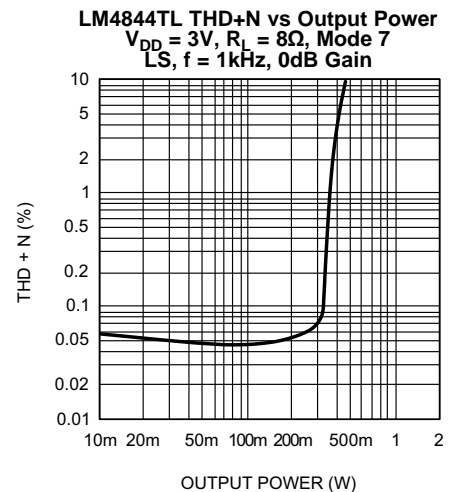

Figure 8.

Typical Performance Characteristics (continued)

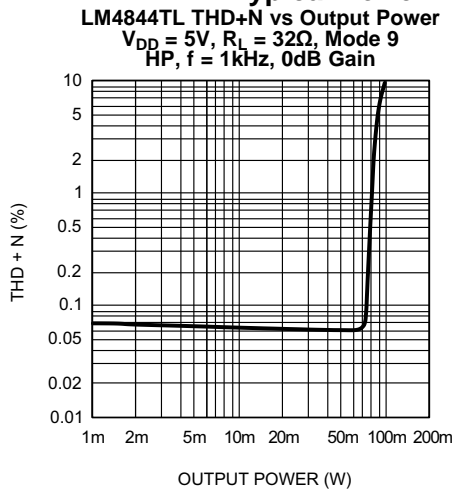

Figure 9.

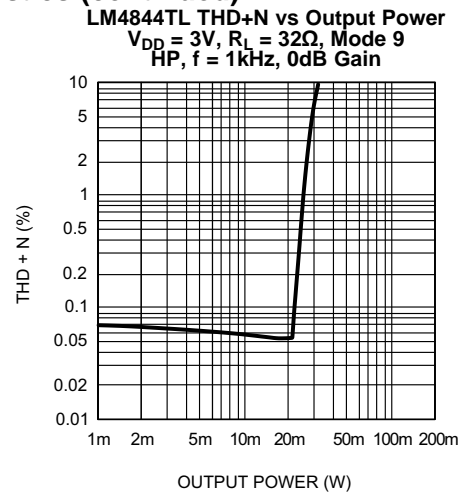

Figure 10.

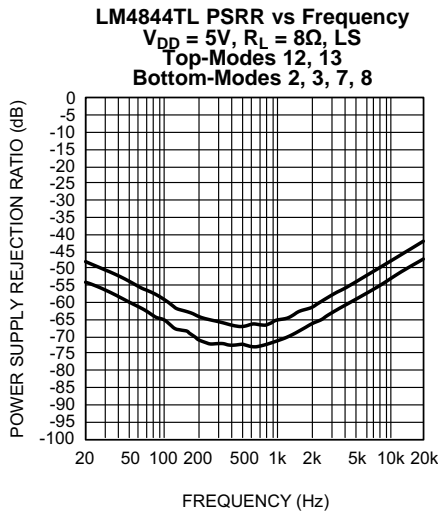

Figure 11.

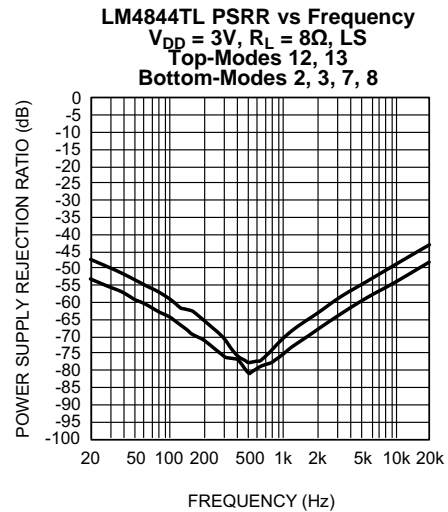

Figure 12.

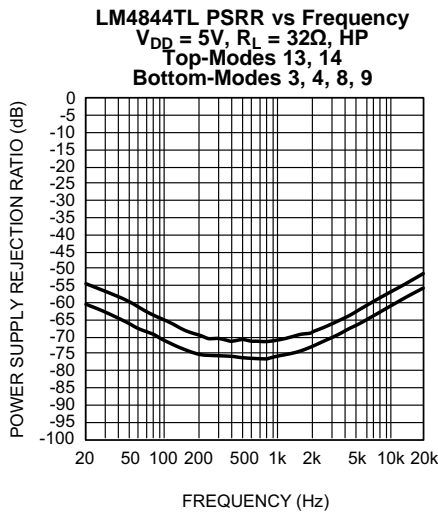

Figure 13.

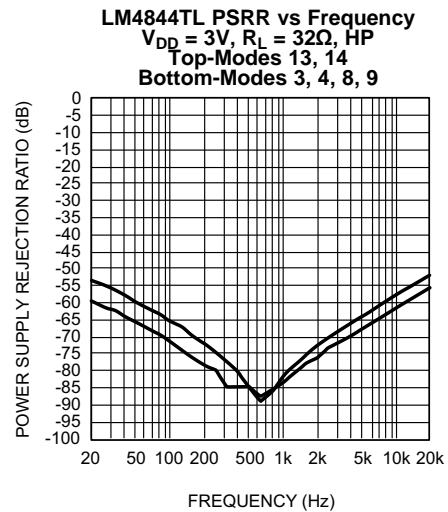

Figure 14.

Typical Performance Characteristics (continued)

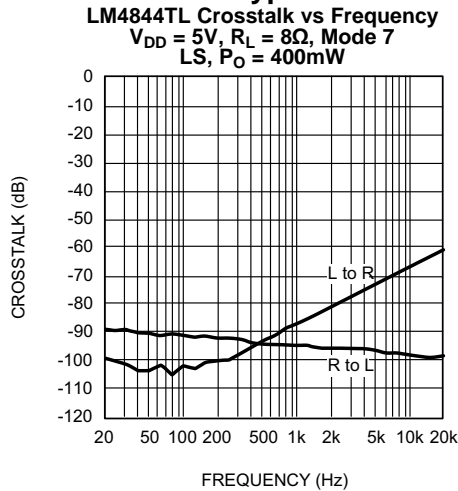

Figure 15.

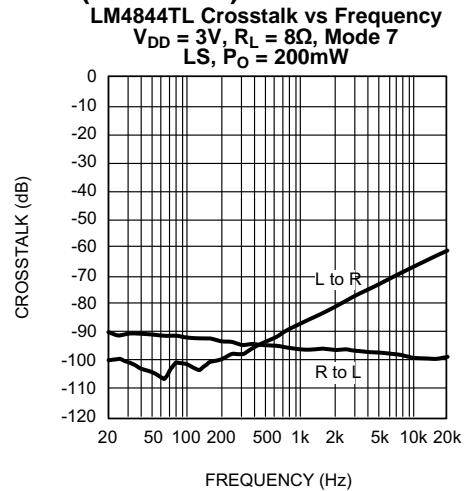

Figure 16.

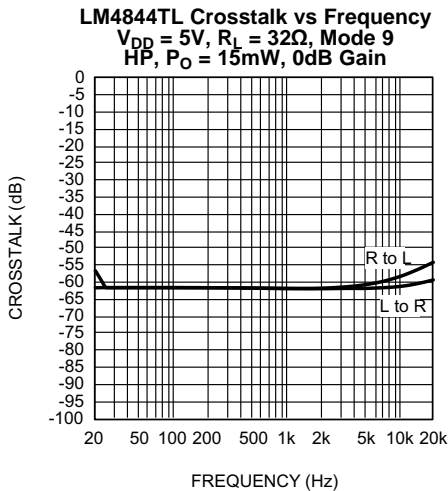

Figure 17.

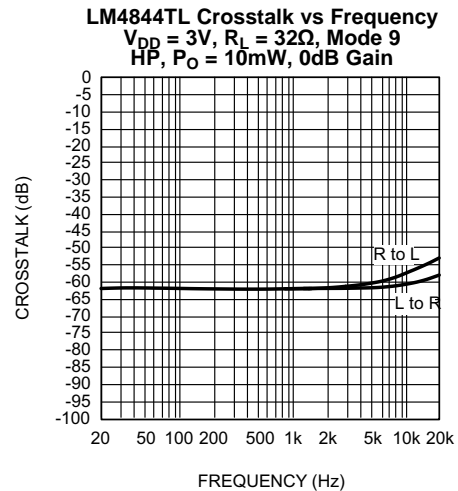

Figure 18.

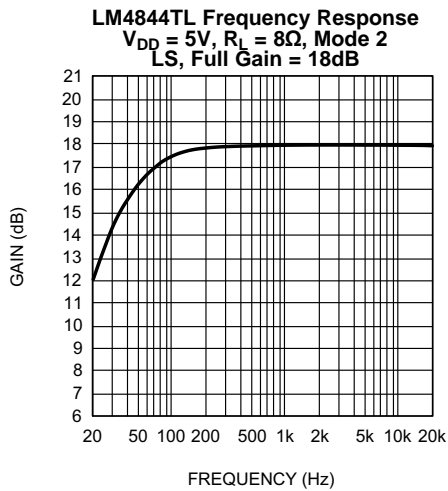

Figure 19.

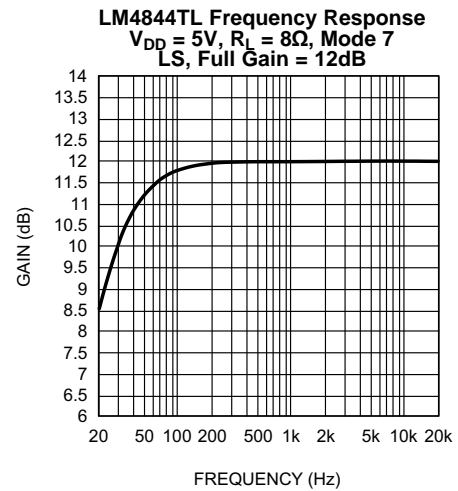

Figure 20.

Typical Performance Characteristics (continued)

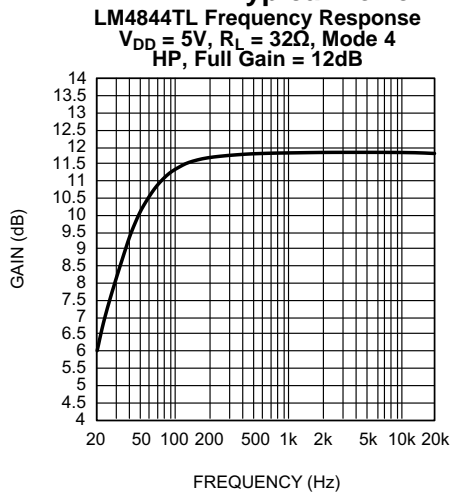

Figure 21.

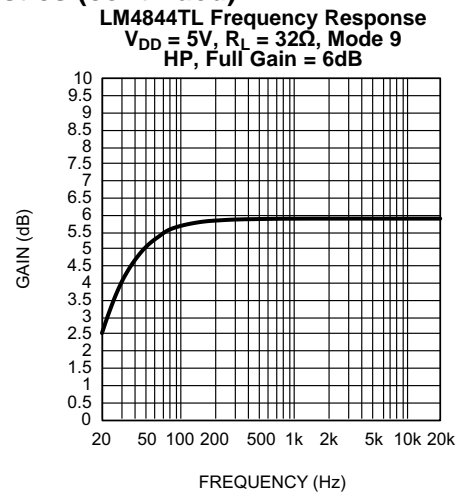

Figure 22.

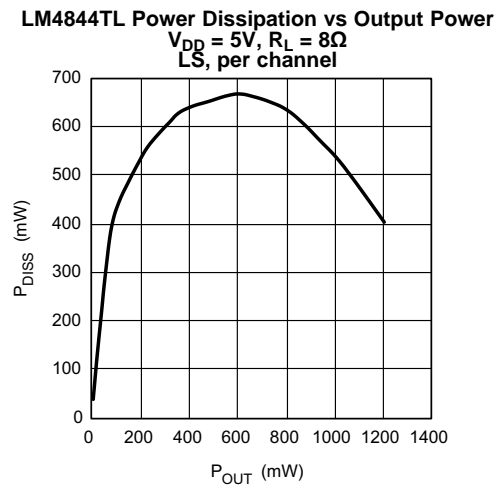

Figure 23.

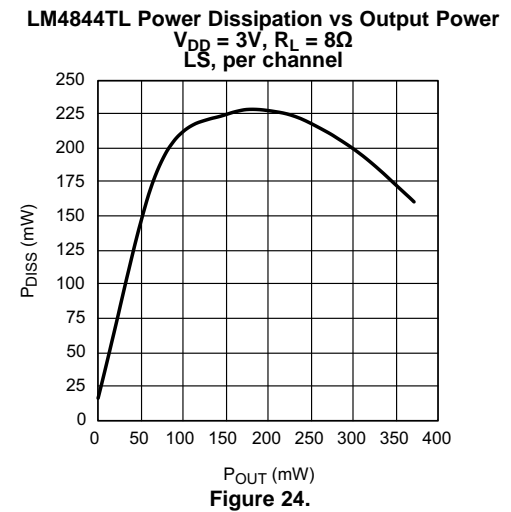

Figure 24.

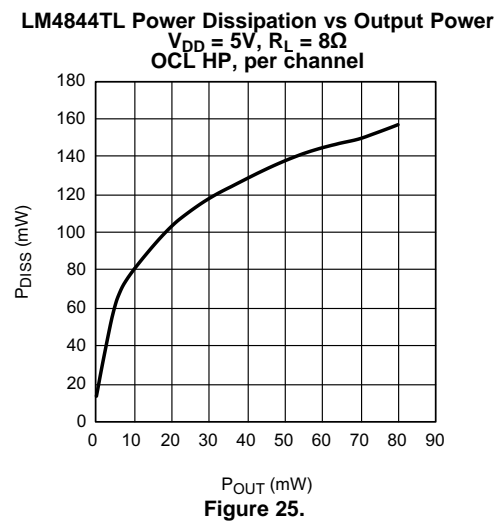

Figure 25.

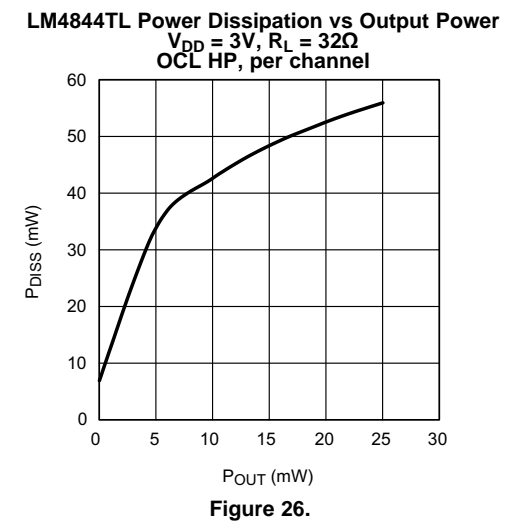

Figure 26.

Typical Performance Characteristics (continued)

LM4844TL Output Power vs Load Resistance, LS
 Top- $V_{DD} = 5V, 10\% THD+N$; Topmid- $V_{DD} = 5V, 1\% THD+N$
 Botmid- $V_{DD} = 3V, 10\% THD+N$;
 Bot- $V_{DD} = 3V, 1\% THD+N$

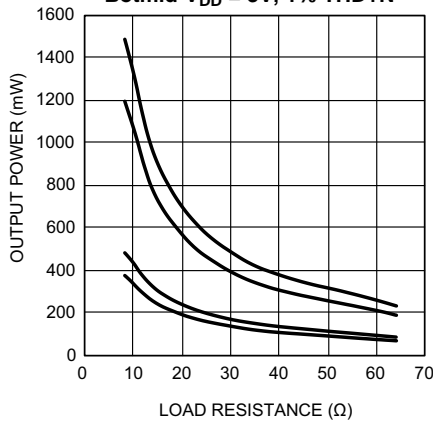

Figure 27.

LM4844TL Output Power vs Load Resistance, HP
 Top- $V_{DD} = 5V, 10\% THD+N$; Topmid- $V_{DD} = 5V, 1\% THD+N$
 Botmid- $V_{DD} = 3V, 10\% THD+N$;
 Bot- $V_{DD} = 3V, 1\% THD+N$

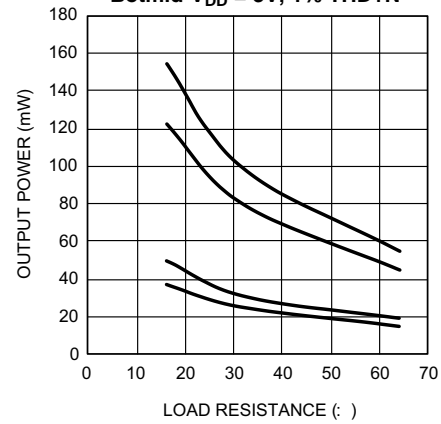

Figure 28.

LM4844TL Output Power vs Supply Voltage, LS
 $R_L = 8\Omega$; Top- $10\% THD+N$, Bot- $1\% THD+N$

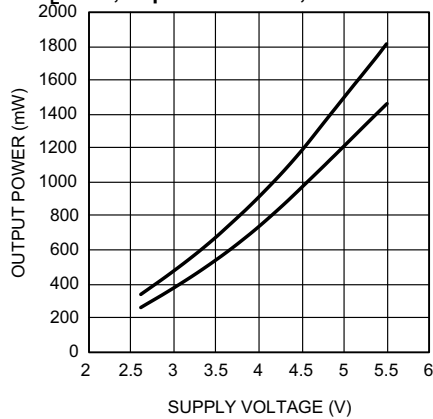

Figure 29.

LM4844TL Output Power vs Supply Voltage, HP
 $R_L = 32\Omega$; Top- $10\% THD+N$, Bot- $1\% THD+N$

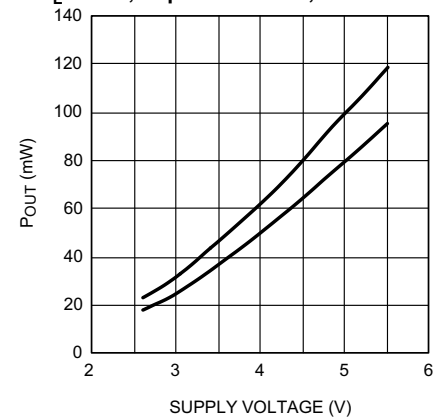

Figure 30.

APPLICATION INFORMATION

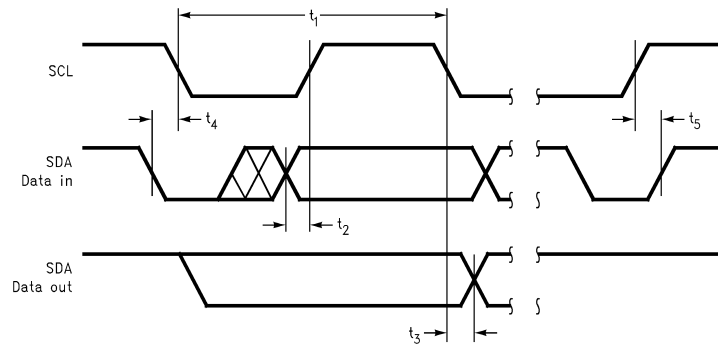

Figure 31. I²C Timing Diagram

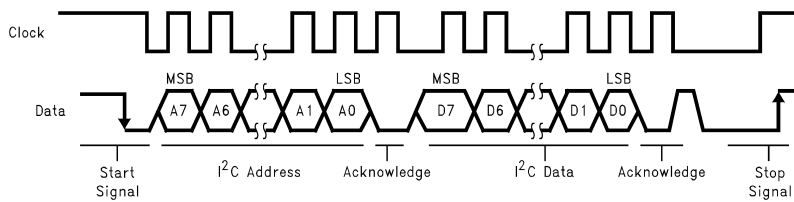

Figure 32. I²C Bus Format

Table 1. Chip Address

	A7	A6	A5	A4	A3	A2	A1	A0
Chip Address	1	1	1	1	1	0	EC	0
ADR = 0	1	1	1	1	1	0	0	0
ADR = 1	1	1	1	1	1	0	1	0

Table 2. Control Registers

	D7	D6	D5	D4	D3	D2	D1	D0
Mono Volume control	0	0	0	MD4	MD3	MD2	MD1	MD0
Left Volume control	0	1	LD5	LD4	LD3	LD2	LD1	LD0
Right Volume control	1	0	RD5	RD4	RD3	RD2	RD1	RD0
Mode control	1	1	CD5	0	CD3	CD2	CD1	CD0

Table 3. Mono Volume Control

MD4	MD3	MD2	MD1	MD0	Gain (dB)
0	0	0	0	0	-34.5
0	0	0	0	1	-33.0
0	0	0	1	0	-31.5
0	0	0	1	1	-30.0
0	0	1	0	0	-28.5
0	0	1	0	1	-27.0
0	0	1	1	0	-25.5
0	0	1	1	1	-24.0
0	1	0	0	0	-22.5
0	1	0	0	1	-21.0
0	1	0	1	0	-19.5
0	1	0	1	1	-18.0

Table 3. Mono Volume Control (continued)

MD4	MD3	MD2	MD1	MD0	Gain (dB)
0	1	1	0	0	-16.5
0	1	1	0	1	-15.0
0	1	1	1	0	-13.5
0	1	1	1	1	-12.0
1	0	0	0	0	-10.5
1	0	0	0	1	-9.0
1	0	0	1	0	-7.5
1	0	0	1	1	-6.0
1	0	1	0	0	-4.5
1	0	1	0	1	-3.0
1	0	1	1	0	-1.5
1	0	1	1	1	0.0
1	1	0	0	0	1.5
1	1	0	0	1	3.0
1	1	0	1	0	4.5
1	1	0	1	1	6.0
1	1	1	0	0	7.5
1	1	1	0	1	9.0
1	1	1	1	0	10.5
1	1	1	1	1	12.0

Table 4. Stereo Volume Control

LD4//RD4	LD3//RD3	LD2//RD2	LD1//RD1	LD0//RD0	Gain (dB)
0	0	0	0	0	-40.5
0	0	0	0	1	-39.0
0	0	0	1	0	-37.5
0	0	0	1	1	-36.0
0	0	1	0	0	-34.5
0	0	1	0	1	-33.0
0	0	1	1	0	-31.5
0	0	1	1	1	-30.0
0	1	0	0	0	-28.5
0	1	0	0	1	-27.0
0	1	0	1	0	-25.5
0	1	0	1	1	-24.0
0	1	1	0	0	-22.5
0	1	1	0	1	-21.0
0	1	1	1	0	-19.5
0	1	1	1	1	-18.0
1	0	0	0	0	-16.5
1	0	0	0	1	-15.0
1	0	0	1	0	-13.5
1	0	0	1	1	-12.0
1	0	1	0	0	-10.5
1	0	1	0	1	-9.0
1	0	1	1	0	-7.5
1	0	1	1	1	-6.0

Table 4. Stereo Volume Control (continued)

LD4//RD4	LD3//RD3	LD2//RD2	LD1//RD1	LD0//RD0	Gain (dB)
1	1	0	0	0	-4.5
1	1	0	0	1	-3.0
1	1	0	1	0	-1.5
1	1	0	1	1	0.0
1	1	1	0	0	1.5
1	1	1	0	1	3.0
1	1	1	1	0	4.5
1	1	1	1	1	6.0

Table 5. Mixer and Output Mode

Mode	CD3	CD2	CD1	CD0	Loudspeaker L	Loudspeaker R	Headphone L	Headphone R
0	0	0	0	0	SD	SD	SD	SD
1	0	0	0	1	RESERVED			
2	0	0	1	0	$2(G_M \times M)$	$2(G_M \times M)$	MUTE	MUTE
3	0	0	1	1	$2(G_M \times M)$	$2(G_M \times M)$	$(G_M \times M)$	$(G_M \times M)$
4	0	1	0	0	SD	SD	$(G_M \times M)$	$(G_M \times M)$
5	0	1	0	1	RESERVED			
6	0	1	1	0	RESERVED			
7	0	1	1	1	$2(G_L \times L)$	$2(G_R \times R)$	MUTE	MUTE
8	1	0	0	0	$2(G_L \times L)$	$2(G_R \times R)$	$(G_L \times L)$	$(G_R \times R)$
9	1	0	0	1	SD	SD	$(G_L \times L)$	$(G_R \times R)$
10	1	0	1	0	RESERVED			
11	1	0	1	1	RESERVED			
12	1	1	0	0	$2(G_L \times L) + 2(G_M \times M)$	$2(G_R \times R) + 2(G_M \times M)$	MUTE	MUTE
13	1	1	0	1	$2(G_L \times L) + 2(G_M \times M)$	$2(G_R \times R) + 2(G_M \times M)$	$(G_L \times L) + (G_M \times M)$	$(G_R \times R) + (G_M \times M)$
14	1	1	1	0	SD	SD	$(G_L \times L) + (G_M \times M)$	$(G_R \times R) + (G_M \times M)$
15	1	1	1	1	RESERVED			

M - M_{IN} Input LevelL - L_{IN} Input LevelR - R_{IN} Input Level G_M - Mono Volume Control Gain G_L - Left Stereo Volume Control Gain G_R - Right Stereo Volume Control Gain

SD - Shutdown

MUTE - Mute

Table 6. Texas Instruments 3D Enhancement

LD5	0	Loudspeaker Texas Instruments 3D Off
	1	Loudspeaker Texas Instruments 3D On
RD5	0	Headphone Texas Instruments 3D Off
	1	Headphone Texas Instruments 3D On

Table 7. Wake-up Time Select

CD5	0	Fast Wake-up Setting
	1	Slow Wake-up Setting

I²C COMPATIBLE INTERFACE

The LM4844 uses a serial bus, which conforms to the I²C protocol, to control the chip's functions with two wires: clock (SCL) and data (SDA). The clock line is uni-directional. The data line is bi-directional (open-collector). The maximum clock frequency specified by the I²C standard is 400kHz. In this discussion, the master is the controlling microcontroller and the slave is the LM4844.

The I²C address for the LM4844 is determined using the ADR pin. The LM4844's two possible I²C chip addresses are of the form 111110X₁0 (binary), where X₁ = 0, if ADR is logic low; and X₁ = 1, if ADR is logic high. If the I²C interface is used to address a number of chips in a system, the LM4844's chip address can be changed to avoid any possible address conflicts.

The bus format for the I²C interface is shown in [Figure 31](#). The bus format diagram is broken up into six major sections:

The "start" signal is generated by lowering the data signal while the clock signal is high. The start signal will alert all devices attached to the I²C bus to check the incoming address against their own address.

The 8-bit chip address is sent next, most significant bit first. The data is latched in on the rising edge of the clock. Each address bit must be stable while the clock level is high.

After the last bit of the address bit is sent, the master releases the data line high (through a pull-up resistor). Then the master sends an acknowledge clock pulse. If the LM4844 has received the address correctly, then it holds the data line low during the clock pulse. If the data line is not held low during the acknowledge clock pulse, then the master should abort the rest of the data transfer to the LM4844.

The 8 bits of data are sent next, most significant bit first. Each data bit should be valid while the clock level is stable high.

After the data byte is sent, the master must check for another acknowledge to see if the LM4844 received the data.

If the master has more data bytes to send to the LM4844, then the master can repeat the previous two steps until all data bytes have been sent.

The "stop" signal ends the transfer. To signal "stop", the data signal goes high while the clock signal is high. The data line should be held high when not in use.

I²C INTERFACE POWER SUPPLY PIN (I²CV_{DD})

The LM4844's I²C interface is powered up through the I²CV_{DD} pin. The LM4844's I²C interface operates at a voltage level set by the I²CV_{DD} pin which can be set independent to that of the main power supply pin V_{DD}. This is ideal whenever logic levels for the I²C interface are dictated by a microcontroller or microprocessor that is operating at a lower supply voltage than the main battery of a portable system.

TEXAS INSTRUMENTS 3D ENHANCEMENT

The LM4844 features a 3D audio enhancement effect that widens the perceived soundstage from a stereo audio signal. The 3D audio enhancement improves the apparent stereo channel separation whenever the left and right speakers are too close to one another, due to system size constraints or equipment limitations.

An external RC network, shown in [Figure 1](#), is required to enable the 3D effect. There are separate RC networks for both the stereo loudspeaker outputs as well as the stereo headphone outputs, so the 3D effect can be set independently for each set of stereo outputs.

The amount of the 3D effect is set by the R_{3D} resistor. Decreasing the value of R_{3D} will increase the 3D effect. The C_{3D} capacitor sets the low cutoff frequency of the 3D effect. Increasing the value of C_{3D} will decrease the low cutoff frequency at which the 3D effect starts to occur, as shown by [Equation 1](#).

$$f_{3D(-3dB)} = 1 / 2\pi(R_{3D})(C_{3D}) \quad (1)$$

Activating the 3D effect will cause an increase in gain by a multiplication factor of $(1 + 20\text{k}\Omega/R_{3D})$. Setting R_{3D} to $20\text{k}\Omega$ will result in a gain increase by a multiplication factor of $(1+20\text{k}\Omega/20\text{k}\Omega) = 2$ or 6dB whenever the 3D effect is activated. The volume control can be programmed through the I²C compatible interface to compensate for the extra 6dB increase in gain. For example, if the stereo volume control is set at 0dB (11011 from Table 4) before the 3D effect is activated, the volume control should be programmed to –6dB (10111 from Table 4) immediately after the 3D effect has been activated. Setting $R_{3D} = 20\text{k}\Omega$ and $C_{3D} = 0.22\mu\text{F}$ allows the LM4844 to produce a pronounced 3D effect with a minimal increase in output noise.

OUTPUT CAPACITOR-LESS (OCL) OPERATION AND LAYOUT TECHNIQUES FOR OPTIMUM CROSSTALK

The LM4844's OCL headphone architecture eliminates output coupling capacitors. Unless the headphone is in shutdown, the OCL output will be at a bias voltage of $\frac{1}{2}V_{DD}$, which is applied to the stereo headphone jack's sleeve. This voltage matches the bias voltage present on LHP and RHP outputs that drive the headphones. The headphones operate in a manner similar to a bridge-tied load (BTL). Because the same DC voltage is applied to both headphone speaker terminals there is no net DC current flow through the speaker. AC current flows through a headphone speaker as an audio signal's output amplitude increases on the speaker's terminal.

The headphone jack's sleeve is not connected to circuit ground when used in OCL mode. Using the headphone output jack as a line-level output will place the LM4844's $\frac{1}{2}V_{DD}$ bias voltage on a plug's sleeve connection.

Since the LHP and RHP outputs of the LM4844 share the OCL output as a reference, certain layout techniques should be used in order to achieve optimum crosstalk performance. The crosstalk will depend on the parasitic resistance of the trace connecting the LM4844 OCL output to the headphone jack sleeve and on the load resistance value. Since the load resistance is often predetermined, it is advisable to use a trace that is as short and as wide as possible. Reasonable application of this layout technique will result in crosstalk values of 60dB, as specified in the electrical characteristics table.

BRIDGE CONFIGURATION EXPLANATION

The LM4844 consists of two sets of bridged-tied amplifier pairs that drive the left loudspeaker (LLS) and the right loudspeaker (RLS). For this discussion, only the LLS bridge-tied amplifier pair will be referred to. The LM4844 drives a load, such as a speaker, connected between outputs, LLS+ and LLS-. In the LLS amplifier block, the output of the amplifier that drives LLS- serves as the input to the unity gain inverting amplifier that drives LLS+.

This results in both amplifiers producing signals identical in magnitude, but 180° out of phase. Taking advantage of this phase difference, a load is placed between LLS- and LLS+ and driven differentially (commonly referred to as 'bridge mode'). This results in a differential or BTL gain of:

$$A_{VD} = 2(R_f / R_i) = 2 \quad (2)$$

Both the feedback resistor, R_f , and the input resistor, R_i , are internally set.

Bridge mode amplifiers are different from single-ended amplifiers that drive loads connected between a single amplifier's output and ground. For a given supply voltage, bridge mode has a distinct advantage over the single-ended configuration: its differential output doubles the voltage swing across the load. Theoretically, this produces four times the output power when compared to a single-ended amplifier under the same conditions. This increase in attainable output power assumes that the amplifier is not current limited and that the output signal is not clipped.

Another advantage of the differential bridge output is no net DC voltage across the load. This is accomplished by biasing LLS- and LLS+ outputs at half-supply. This eliminates the coupling capacitor that single supply, single-ended amplifiers require. Eliminating an output coupling capacitor in a typical single-ended configuration forces a single-supply amplifier's half-supply bias voltage across the load. This increases internal IC power dissipation and may permanently damage loads such as speakers.

POWER DISSIPATION

Power dissipation is a major concern when designing a successful single-ended or bridged amplifier.

A direct consequence of the increased power delivered to the load by a bridge amplifier is higher internal power dissipation. The LM4844 has 2 sets of bridged-tied amplifier pairs driving LLS and RLS. The maximum internal power dissipation operating in the bridge mode is twice that of a single-ended amplifier. From [Equation 3](#) and [Equation 4](#), assuming a 5V power supply and an 8Ω load, the maximum power dissipation for LLS and RLS is 634mW per channel.

$$P_{D\text{MAX-LLS}} = 4(V_{DD})^2 / (2\pi^2 R_L): \text{ Bridged} \quad (3)$$

$$P_{\text{DMAX-RLS}} = 4(V_{\text{DD}})^2 / (2\pi^2 R_L): \text{ Bridged} \quad (4)$$

The LM4844 also has a pair of single-ended amplifiers driving LHP and RHP. The maximum internal power dissipation for ROUT and LOUT is given by [Equation 5](#) and [Equation 6](#). From [Equation 5](#) and [Equation 6](#), assuming a 5V power supply and a 32Ω load, the maximum power dissipation for LOUT and ROUT is 40mW per channel.

$$P_{\text{DMAX-LHP}} = (V_{\text{DD}})^2 / (2\pi^2 R_L): \text{ Single-ended} \quad (5)$$

$$P_{\text{DMAX-RHP}} = (V_{\text{DD}})^2 / (2\pi^2 R_L): \text{ Single-ended} \quad (6)$$

The maximum internal power dissipation of the LM4844 occurs during output modes 3, 8, and 13 when both loudspeaker and headphone amplifiers are simultaneously on; and is given by [Equation 7](#).

$$P_{\text{DMAX-TOTAL}} = P_{\text{DMAX-LLS}} + P_{\text{DMAX-RLS}} + P_{\text{DMAX-LHP}} + P_{\text{DMAX-RHP}} \quad (7)$$

The maximum power dissipation point given by [Equation 7](#) must not exceed the power dissipation given by [Equation 8](#):

$$P_{\text{DMAX}'} = (T_{\text{JMAX}} - T_A) / \theta_{\text{JA}} \quad (8)$$

The LM4844's $T_{\text{JMAX}} = 150^\circ\text{C}$. In the TL package, the LM4844's θ_{JA} is 62°C/W . At any given ambient temperature T_A , use [Equation 8](#) to find the maximum internal power dissipation supported by the IC packaging. Rearranging [Equation 8](#) and substituting $P_{\text{DMAX-TOTAL}}$ for $P_{\text{DMAX}'}$ results in [Equation 9](#). This equation gives the maximum ambient temperature that still allows maximum stereo power dissipation without violating the LM4844's maximum junction temperature.

$$T_A = T_{\text{JMAX}} - P_{\text{DMAX-TOTAL}} \theta_{\text{JA}} \quad (9)$$

For a typical application with a 5V power supply, stereo 8Ω loudspeaker load, and the stereo 32Ω headphone load, the maximum ambient temperature that allows maximum stereo power dissipation without exceeding the maximum junction temperature is approximately 100°C for the TL package.

$$T_{\text{JMAX}} = P_{\text{DMAX-TOTAL}} \theta_{\text{JA}} + T_A \quad (10)$$

[Equation 10](#) gives the maximum junction temperature T_{JMAX} . If the result violates the LM4844's 150°C , reduce the maximum junction temperature by reducing the power supply voltage or increasing the load resistance. Further allowance should be made for increased ambient temperatures.

The above examples assume that a device is a surface mount part operating around the maximum power dissipation point. Since internal power dissipation is a function of output power, higher ambient temperatures are allowed as output power or duty cycle decreases. If the result of [Equation 7](#) is greater than that of [Equation 8](#), then decrease the supply voltage, increase the load impedance, or reduce the ambient temperature. If these measures are insufficient, a heat sink can be added to reduce θ_{JA} . The heat sink can be created using additional copper area around the package, with connections to the ground pin(s), supply pin and amplifier output pins. External, solder attached SMT heatsinks such as the Thermalloy 7106D can also improve power dissipation. When adding a heat sink, the θ_{JA} is the sum of θ_{JC} , θ_{CS} , and θ_{SA} . (θ_{JC} is the junction-to-case thermal impedance, θ_{CS} is the case-to-sink thermal impedance, and θ_{SA} is the sink-to-ambient thermal impedance.) Refer to the [Typical Performance Characteristics](#) curves for power dissipation information at lower output power levels.

POWER SUPPLY BYPASSING

As with any power amplifier, proper supply bypassing is critical for low noise performance and high power supply rejection. Applications that employ a 5V regulator typically use a 10μF in parallel with a 0.1μF filter capacitors to stabilize the regulator's output, reduce noise on the supply line, and improve the supply's transient response. However, their presence does not eliminate the need for a local 1.0μF tantalum bypass capacitance connected between the LM4844's supply pins and ground. Keep the length of leads and traces that connect capacitors between the LM4844's power supply pin and ground as short as possible.

SELECTING EXTERNAL COMPONENTS

Input Capacitor Value Selection

Amplifying the lowest audio frequencies requires a high value input coupling capacitor (C_i in [Figure 1](#)). In many cases, however, the speakers used in portable systems, whether internal or external, have little ability to reproduce signals below 50Hz. Applications using speakers with this limited frequency response reap little improvement; by using a large input capacitor.

The internal input resistor (R_i) and the input capacitor (C_i) produce a high pass filter cutoff frequency that is found using Equation 11.

$$f_c = 1 / (2\pi R_i C_i) \tag{11}$$

As an example when using a speaker with a low frequency limit of 50Hz and $R_i = 20k\Omega$, C_i , using Equation 11 is $0.19\mu F$. The $0.22\mu F$ C_i shown in Figure 33 allows the LM4844 to drive high efficiency, full range speaker whose response extends below 40Hz.

Bypass Capacitor Value Selection

Besides minimizing the input capacitor size, careful consideration should be paid to value of C_B , the capacitor connected to the BYPASS pin. Since C_B determines how fast the LM4844 settles to quiescent operation, its value is critical when minimizing turn-on pops. The slower the LM4844's outputs ramp to their quiescent DC voltage (nominally $V_{DD}/2$), the smaller the turn-on pop. Choosing C_B equal to $2.2\mu F$ along with a small value of C_i (in the range of $0.1\mu F$ to $0.39\mu F$), produces a click-less and pop-less shutdown function. As discussed above, choosing C_i no larger than necessary for the desired bandwidth helps minimize clicks and pops. C_B 's value should be in the range of 5 times to 10 times the value of C_i . This ensures that output transients are eliminated when the LM4844 transitions in and out of shutdown mode. Connecting a $2.2\mu F$ capacitor, C_B , between the BYPASS pin and ground improves the internal bias voltage's stability and improves the amplifier's PSRR. The PSRR improvements increase as the bypass pin capacitor value increases. However, increasing the value of C_B will increase wake-up time. The selection of bypass capacitor value, C_B , depends on desired PSRR requirements, click and pop performance, wake-up time, system cost, and size constraints.

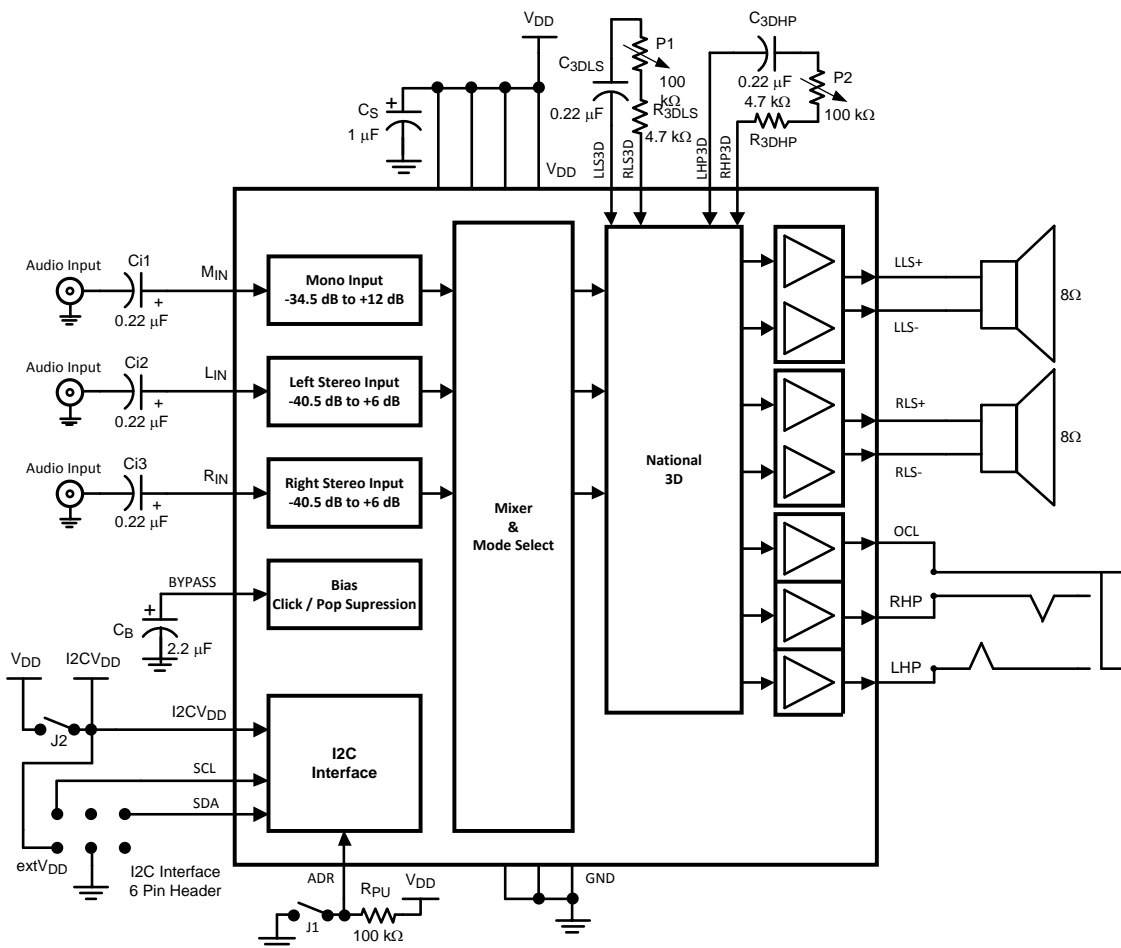

Figure 33. Reference Design Board Schematic

Demonstration Board Layout

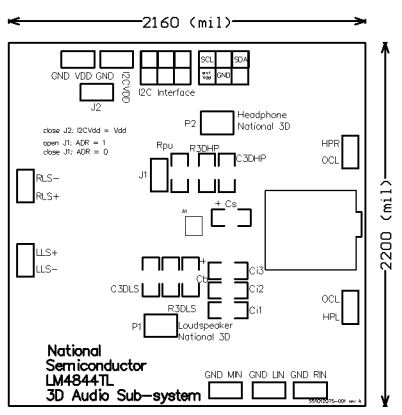

Figure 34. Recommended YZR PCB Layout: Silkscreen Layer

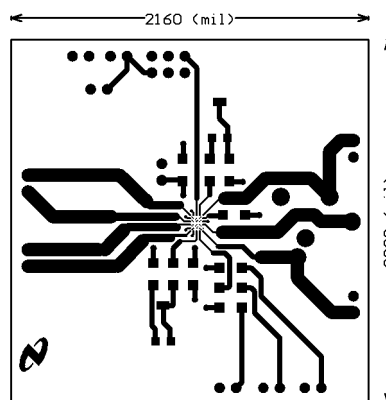

Figure 35. Recommended YZR PCB Layout: Top Layer

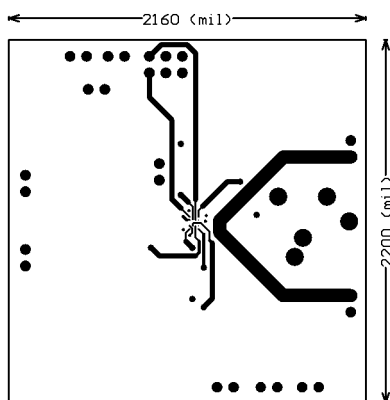

Figure 36. Recommended YZR PCB Layout: Mid Layer 1

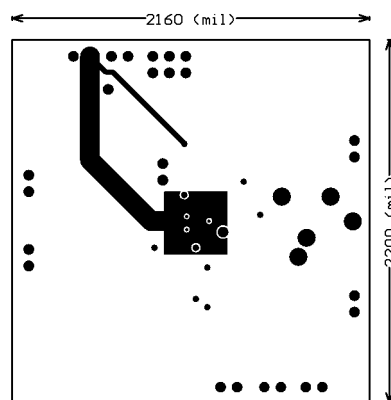

Figure 37. Recommended YZR PCB Layout: Mid Layer 2

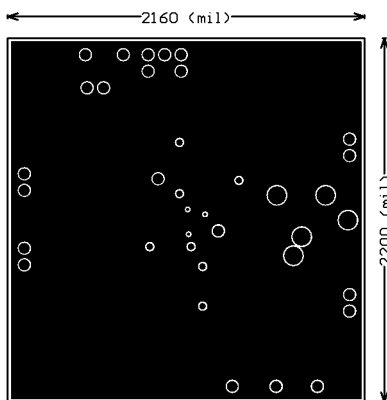

Figure 38. Recommended YZR PCB Layout: Bottom Layer

Revision History

Rev	Date	Description
1.1	06/01/06	Initial WEB.
1.2	07/20/07	Edited the Control Interface Electrical Characteristics tables.
1.3	08/07/07	Changed the I^2C Vdd from 1.8V into 1.7V (under the Operating Ratings).
1.4	08/23/07	Fixed one place of typo.
D	04/05/13	Changed layout of National Data Sheet to TI format

PACKAGING INFORMATION

Orderable Device	Status (1)	Package Type	Package Drawing	Pins	Package Qty	Eco Plan (2)	Lead/Ball Finish	MSL Peak Temp (3)	Op Temp (°C)	Top-Side Markings (4)	Samples
LM4844TL/NOPB	ACTIVE	DSBGA	YZR	30	250	Green (RoHS & no Sb/Br)	SNAGCU	Level-1-260C-UNLIM	-40 to 85	GF3	Samples
LM4844TLX/NOPB	ACTIVE	DSBGA	YZR	30	3000	Green (RoHS & no Sb/Br)	SNAGCU	Level-1-260C-UNLIM	-40 to 85	GF3	Samples

(1) The marketing status values are defined as follows:

ACTIVE: Product device recommended for new designs.

LIFEBUY: TI has announced that the device will be discontinued, and a lifetime-buy period is in effect.

NRND: Not recommended for new designs. Device is in production to support existing customers, but TI does not recommend using this part in a new design.

PREVIEW: Device has been announced but is not in production. Samples may or may not be available.

OBSOLETE: TI has discontinued the production of the device.

(2) Eco Plan - The planned eco-friendly classification: Pb-Free (RoHS), Pb-Free (RoHS Exempt), or Green (RoHS & no Sb/Br) - please check <http://www.ti.com/productcontent> for the latest availability information and additional product content details.

TBD: The Pb-Free/Green conversion plan has not been defined.

Pb-Free (RoHS): TI's terms "Lead-Free" or "Pb-Free" mean semiconductor products that are compatible with the current RoHS requirements for all 6 substances, including the requirement that lead not exceed 0.1% by weight in homogeneous materials. Where designed to be soldered at high temperatures, TI Pb-Free products are suitable for use in specified lead-free processes.

Pb-Free (RoHS Exempt): This component has a RoHS exemption for either 1) lead-based flip-chip solder bumps used between the die and package, or 2) lead-based die adhesive used between the die and leadframe. The component is otherwise considered Pb-Free (RoHS compatible) as defined above.

Green (RoHS & no Sb/Br): TI defines "Green" to mean Pb-Free (RoHS compatible), and free of Bromine (Br) and Antimony (Sb) based flame retardants (Br or Sb do not exceed 0.1% by weight in homogeneous material)

(3) MSL, Peak Temp. -- The Moisture Sensitivity Level rating according to the JEDEC industry standard classifications, and peak solder temperature.

(4) Multiple Top-Side Markings will be inside parentheses. Only one Top-Side Marking contained in parentheses and separated by a "~" will appear on a device. If a line is indented then it is a continuation of the previous line and the two combined represent the entire Top-Side Marking for that device.

Important Information and Disclaimer: The information provided on this page represents TI's knowledge and belief as of the date that it is provided. TI bases its knowledge and belief on information provided by third parties, and makes no representation or warranty as to the accuracy of such information. Efforts are underway to better integrate information from third parties. TI has taken and continues to take reasonable steps to provide representative and accurate information but may not have conducted destructive testing or chemical analysis on incoming materials and chemicals. TI and TI suppliers consider certain information to be proprietary, and thus CAS numbers and other limited information may not be available for release.

In no event shall TI's liability arising out of such information exceed the total purchase price of the TI part(s) at issue in this document sold by TI to Customer on an annual basis.

TAPE AND REEL INFORMATION



QUADRANT ASSIGNMENTS FOR PIN 1 ORIENTATION IN TAPE



*All dimensions are nominal

Device	Package Type	Package Drawing	Pins	SPQ	Reel Diameter (mm)	Reel Width W1 (mm)	A0 (mm)	B0 (mm)	K0 (mm)	P1 (mm)	W (mm)	Pin1 Quadrant
LM4844TL/NOPB	DSBGA	YZR	30	250	178.0	8.4	2.74	3.15	0.76	4.0	8.0	Q1
LM4844TLX/NOPB	DSBGA	YZR	30	3000	178.0	8.4	2.74	3.15	0.76	4.0	8.0	Q1

TAPE AND REEL BOX DIMENSIONS

*All dimensions are nominal

Device	Package Type	Package Drawing	Pins	SPQ	Length (mm)	Width (mm)	Height (mm)
LM4844TL/NOPB	DSBGA	YZR	30	250	210.0	185.0	35.0
LM4844TLX/NOPB	DSBGA	YZR	30	3000	210.0	185.0	35.0

YZR0030

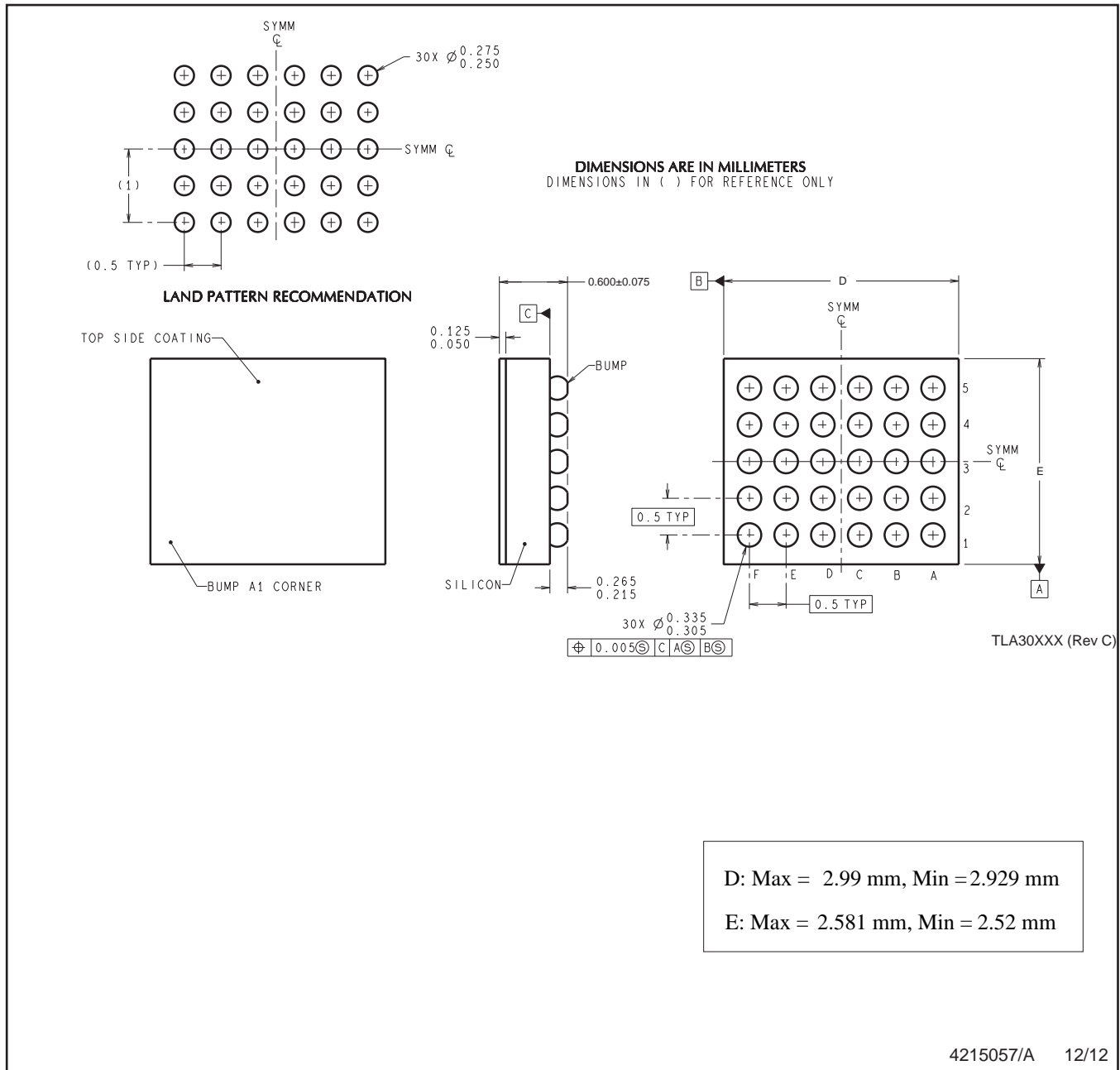

NOTES: A. All linear dimensions are in millimeters. Dimensioning and tolerancing per ASME Y14.5M-1994.
B. This drawing is subject to change without notice.

4215057/A 12/12

IMPORTANT NOTICE

Texas Instruments Incorporated and its subsidiaries (TI) reserve the right to make corrections, enhancements, improvements and other changes to its semiconductor products and services per JESD46, latest issue, and to discontinue any product or service per JESD48, latest issue. Buyers should obtain the latest relevant information before placing orders and should verify that such information is current and complete. All semiconductor products (also referred to herein as "components") are sold subject to TI's terms and conditions of sale supplied at the time of order acknowledgment.

TI warrants performance of its components to the specifications applicable at the time of sale, in accordance with the warranty in TI's terms and conditions of sale of semiconductor products. Testing and other quality control techniques are used to the extent TI deems necessary to support this warranty. Except where mandated by applicable law, testing of all parameters of each component is not necessarily performed.

TI assumes no liability for applications assistance or the design of Buyers' products. Buyers are responsible for their products and applications using TI components. To minimize the risks associated with Buyers' products and applications, Buyers should provide adequate design and operating safeguards.

TI does not warrant or represent that any license, either express or implied, is granted under any patent right, copyright, mask work right, or other intellectual property right relating to any combination, machine, or process in which TI components or services are used. Information published by TI regarding third-party products or services does not constitute a license to use such products or services or a warranty or endorsement thereof. Use of such information may require a license from a third party under the patents or other intellectual property of the third party, or a license from TI under the patents or other intellectual property of TI.

Reproduction of significant portions of TI information in TI data books or data sheets is permissible only if reproduction is without alteration and is accompanied by all associated warranties, conditions, limitations, and notices. TI is not responsible or liable for such altered documentation. Information of third parties may be subject to additional restrictions.

Resale of TI components or services with statements different from or beyond the parameters stated by TI for that component or service voids all express and any implied warranties for the associated TI component or service and is an unfair and deceptive business practice. TI is not responsible or liable for any such statements.

Buyer acknowledges and agrees that it is solely responsible for compliance with all legal, regulatory and safety-related requirements concerning its products, and any use of TI components in its applications, notwithstanding any applications-related information or support that may be provided by TI. Buyer represents and agrees that it has all the necessary expertise to create and implement safeguards which anticipate dangerous consequences of failures, monitor failures and their consequences, lessen the likelihood of failures that might cause harm and take appropriate remedial actions. Buyer will fully indemnify TI and its representatives against any damages arising out of the use of any TI components in safety-critical applications.

In some cases, TI components may be promoted specifically to facilitate safety-related applications. With such components, TI's goal is to help enable customers to design and create their own end-product solutions that meet applicable functional safety standards and requirements. Nonetheless, such components are subject to these terms.

No TI components are authorized for use in FDA Class III (or similar life-critical medical equipment) unless authorized officers of the parties have executed a special agreement specifically governing such use.

Only those TI components which TI has specifically designated as military grade or "enhanced plastic" are designed and intended for use in military/aerospace applications or environments. Buyer acknowledges and agrees that any military or aerospace use of TI components which have **not** been so designated is solely at the Buyer's risk, and that Buyer is solely responsible for compliance with all legal and regulatory requirements in connection with such use.

TI has specifically designated certain components as meeting ISO/TS16949 requirements, mainly for automotive use. In any case of use of non-designated products, TI will not be responsible for any failure to meet ISO/TS16949.

Products

Audio	www.ti.com/audio
Amplifiers	amplifier.ti.com
Data Converters	dataconverter.ti.com
DLP® Products	www.dlp.com
DSP	dsp.ti.com
Clocks and Timers	www.ti.com/clocks
Interface	interface.ti.com
Logic	logic.ti.com
Power Mgmt	power.ti.com
Microcontrollers	microcontroller.ti.com
RFID	www.ti-rfid.com
OMAP Applications Processors	www.ti.com/omap
Wireless Connectivity	www.ti.com/wirelessconnectivity

Applications

Automotive and Transportation	www.ti.com/automotive
Communications and Telecom	www.ti.com/communications
Computers and Peripherals	www.ti.com/computers
Consumer Electronics	www.ti.com/consumer-apps
Energy and Lighting	www.ti.com/energy
Industrial	www.ti.com/industrial
Medical	www.ti.com/medical
Security	www.ti.com/security
Space, Avionics and Defense	www.ti.com/space-avionics-defense
Video and Imaging	www.ti.com/video

TI E2E Community

e2e.ti.com