

## 阅读申明

- 1.本站收集的数据手册和产品资料都来自互联网，版权归原作者所有。如读者和版权方有任何异议请及时告之，我们将妥善解决。
- 2.本站提供的中文数据手册是英文数据手册的中文翻译，其目的是协助用户阅读，该译文无法自动跟随原稿更新，同时也可能存在翻译上的不当。建议读者以英文原稿为参考以便获得更精准的信息。
- 3.本站提供的产品资料，来自厂商的技术支持或者使用者的心得体会等，其内容可能存在描述上的差异，建议读者做出适当判断。
- 4.如需与我们联系，请发邮件到marketing@iczoom.com，主题请标有“数据手册”字样。

## Read Statement

1. The datasheets and other product information on the site are all from network reference or other public materials, and the copyright belongs to the original author and original published source. If readers and copyright owners have any objections, please contact us and we will deal with it in a timely manner.
2. The Chinese datasheets provided on the website is a Chinese translation of the English datasheets. Its purpose is for reader's learning exchange only and do not involve commercial purposes. The translation cannot be automatically updated with the original manuscript, and there may also be improper translations. Readers are advised to use the English manuscript as a reference for more accurate information.
3. All product information provided on the website refer to solutions from manufacturers' technical support or users the contents may have differences in description, and readers are advised to take the original article as the standard.
4. If you have any questions, please contact us at marketing@iczoom.com and mark the subject with "Datasheets" .

## 28 Gbps, AND / NAND / OR / NOR GATE WITH PROGRAMMABLE OUTPUT VOLTAGE

### Typical Applications

The HMC852LC3C is ideal for:

- Serial Data Transmission up to 28 Gbps
- Digital Logic Systems up to 28 Gbps
- NRZ-to-RZ/RH Conversion
- Differential Encoding
- DPSK & Duobinary Transmitter Modules
- Broadband Test & Measurement

### Features

- Inputs Terminated Internally in 50 Ohms
- Differential or Single-Ended Operation
- Fast Rise and Fall Times: 15 / 14 ps
- Low Power Consumption: 241 mW typ.
- Programmable Differential Output Voltage Swing: 600 - 1450 mVp-p
- Propagation Delay: 98 ps
- Single Supply: -3.3 V
- 16 Lead Ceramic 3x3 mm SMT Package: 9 mm<sup>2</sup>

### Functional Diagram

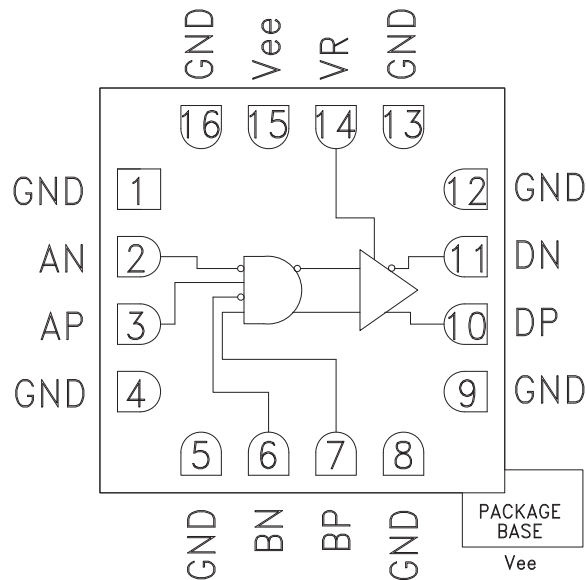

### General Description

The HMC852LC3C is an AND/NAND/OR/NOR gate function that is designed to support data transmission rates of up to 28 Gbps, and clock frequencies as high as 28 GHz.

All differential inputs to the HMC852LC3C are CML and terminated on-chip with 50 Ohms to the positive supply, GND, and may be DC or AC coupled. Outputs can be connected directly to a 50 Ohm ground-terminated system or drive devices with CML logic input. The HMC852LC3C also features an output level control pin, VR, which allows for loss compensation or signal level optimization. The HMC852LC3C operates from a single -3.3 V supply and is available in ROHS-compliant 3x3 mm SMT package.

### Electrical Specifications, $T_A = +25^\circ\text{C}$ , $V_{ee} = -3.3\text{ V}$ , $V_R = 0\text{ V}$

Parameter	Conditions	Min.	Typ.	Max	Units
Power Supply Voltage		-3.6	-3.3	-3.0	V
Power Supply Current			73		mA
Maximum Data Rate			28		Gbps
Maximum Clock Rate			28		GHz
Input Voltage Range		-1.5		0.5	V
Input Differential Voltage		0.1		2.0	Vp-p
Input Return Loss	Frequency <18 GHz		10		dB
Output Amplitude	Single-Ended, peak-to-peak		600		mVp-p
	Differential, peak-to-peak		1200		mVp-p
Output High Voltage			-25		mV

## 28 Gbps, AND / NAND / OR / NOR GATE WITH PROGRAMMABLE OUTPUT VOLTAGE

### Electrical Specifications (continued)

Parameter	Conditions	Min.	Typ.	Max	Units
Output Low Voltage			-625		mV
Output Rise / Fall Time	Differential, 20% - 80%		15 / 14		ps
Output Return Loss	Frequency <22 GHz		10		dB
Small Signal Gain			50		dB
Random Jitter Jr	rms		0.09	0.13	ps rms
Deterministic Jitter, Jd	peak-to-peak, 2 <sup>15</sup> -1 PRBS input [1]		2		ps, p-p
Propagation Delay, A to D, TpdA			98		ps
Propagation Delay, B to D, TpdB			98		ps
VR Pin Current	VR = 0.0 V		3		mA
VR Pin Current	VR = 0.4 V			4.25	mA

[1] Added jitter calculated by de-embedding the source's jitter at 13 Gbps, 2<sup>15</sup>-1 PRBS input.

**DC Current vs. Supply Voltage [1][2]**

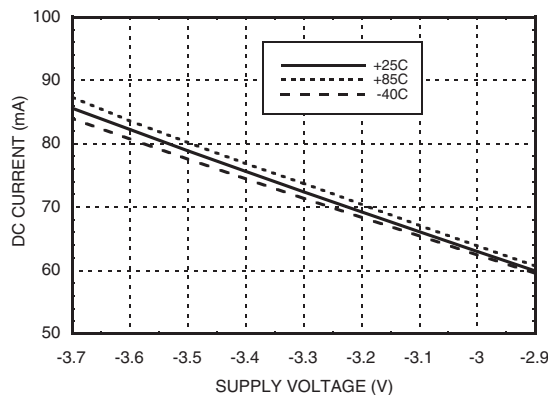

**DC Current vs. VR [2][3]**

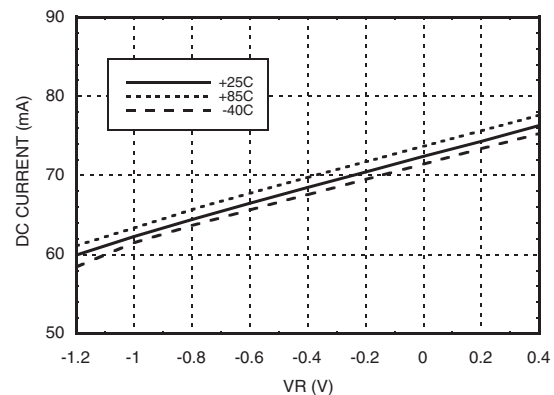

**Output Differential Voltage vs. Supply Voltage [1][2]**

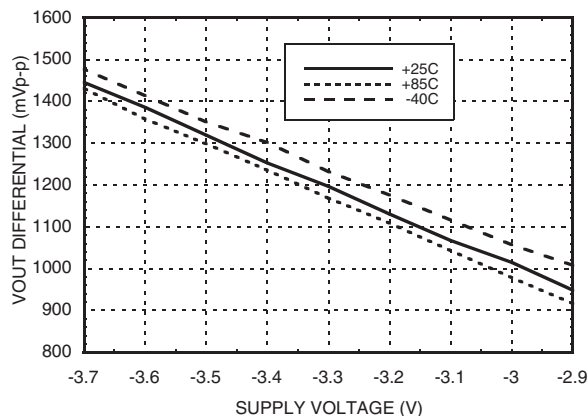

**Output Differential Voltage vs. VR [2][3]**

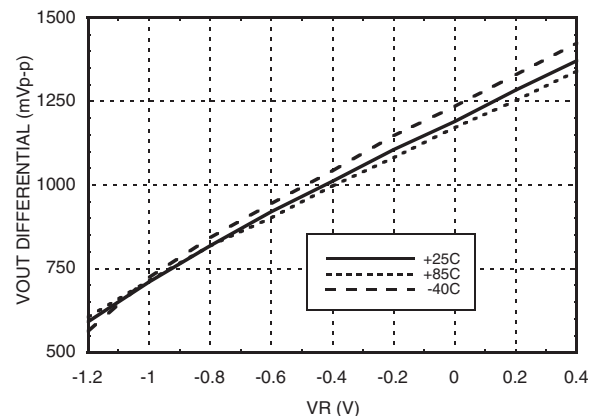

[1] VR = 0.0 V

[2] Frequency = 28 GHz

[3] Vee = -3.3 V

## 28 Gbps, AND / NAND / OR / NOR GATE WITH PROGRAMMABLE OUTPUT VOLTAGE

3

HIGH SPEED LOGIC - SMT

**Rise / Fall Time vs. Supply Voltage [1][2]**

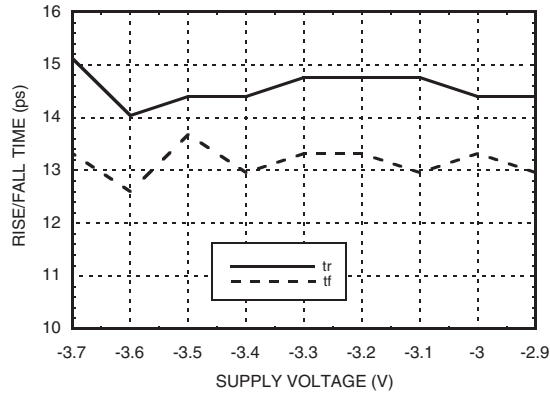

**Rise / Fall Time vs. VR [2][3]**

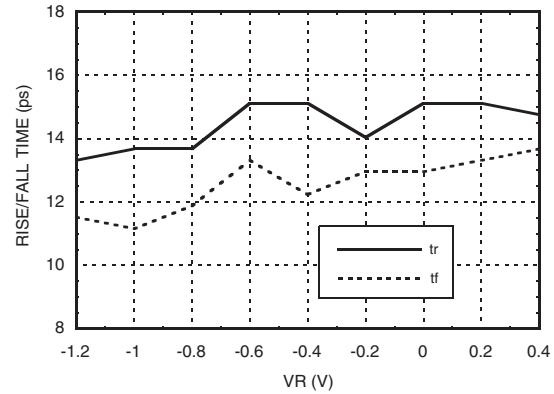

**Input Return Loss Port A [1][3][5]**

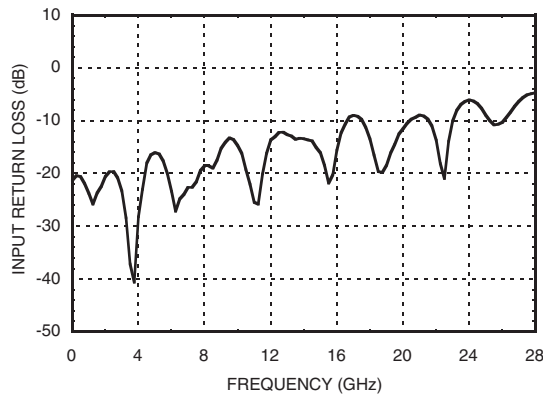

**Input Return Loss Port B [1][3][5]**

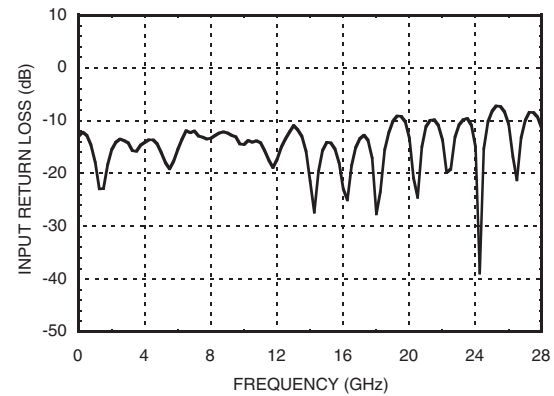

**Output Return Loss [1][3][5]**

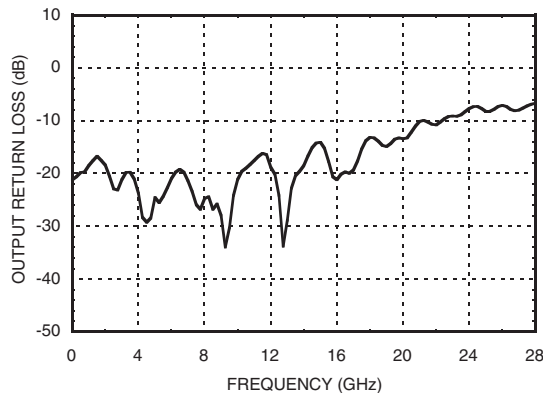

**Response vs. Input Power [1][4][5]**

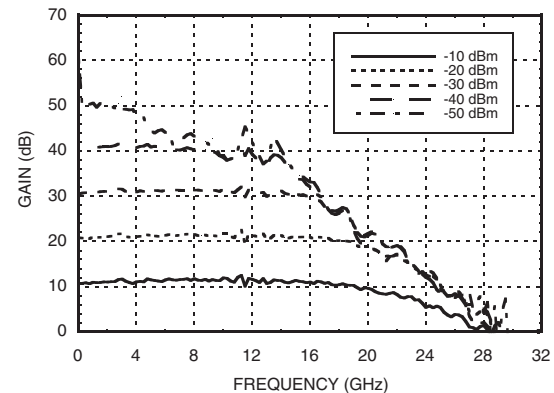

[1] VR = 0.0 V    [2] Frequency = 28 GHz    [3] Device measured on evaluation board with single-ended time domain gating.  
[4] Device measured on evaluation board with single ended time domain port extensions    [5] Vee = -3.3 V



## 28 Gbps, AND / NAND / OR / NOR GATE WITH PROGRAMMABLE OUTPUT VOLTAGE

### Eye Diagram

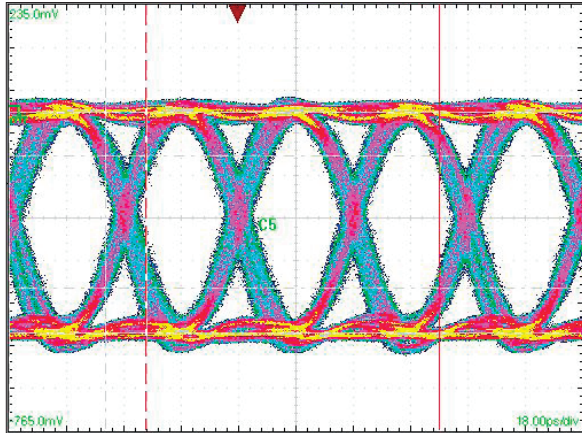

[1] Test Conditions:  
 Single ended 400 mV data input. Pattern generated with  $2^{15} - 1$  PN patterns applied to the inputs resulting in a Quasi-Periodic PRBS pattern at 28 Gbps. Measured using Tektronix CSA 8000.

### Timing Diagram

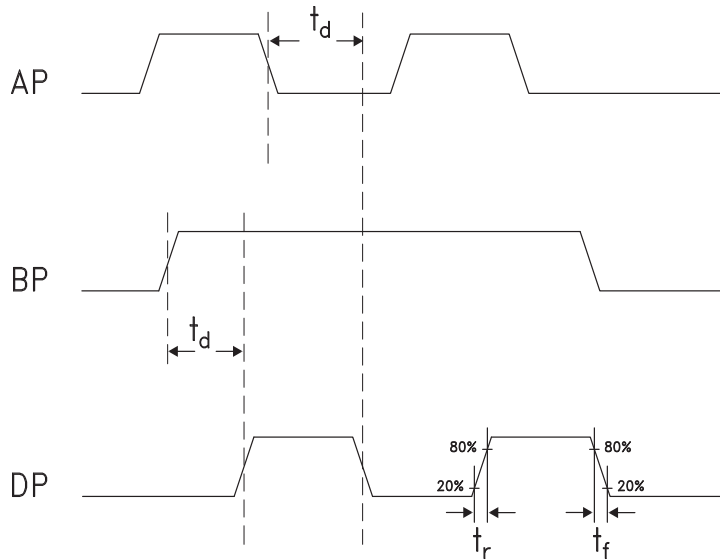

### Truth Table

Input		Outputs
A	B	D
L	L	L
L	H	L
H	L	L
H	H	H

Notes:  
 A = AP - AN  
 B = BP - BN  
 D = DP - DN

H - Positive voltage level  
 L - Negative voltage level



## 28 Gbps, AND / NAND / OR / NOR GATE WITH PROGRAMMABLE OUTPUT VOLTAGE

### Absolute Maximum Ratings

Power Supply Voltage (Vee)	-3.75 V to +0.5 V
Input Signals	-2 V to +0.5 V
Output Signals	-1.5 V to +1 V
Continuous P <sub>diss</sub> (T = 85 °C) (derate 17 mW/°C above 85 °C)	0.68 W
Thermal Resistance (R <sub>th j-p</sub> ) Worst case junction to package paddle	59 °C/W
Maximum Junction Temperature	125 °C
Storage Temperature	-65 °C to +150 °C
Operating Temperature	-40 °C to +85 °C
ESD Sensitivity (HBM)	Class 1C



ELECTROSTATIC SENSITIVE DEVICE  
OBSERVE HANDLING PRECAUTIONS

### Outline Drawing

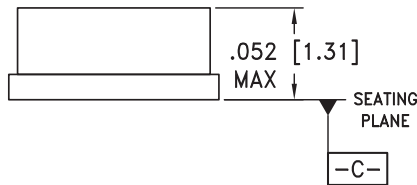
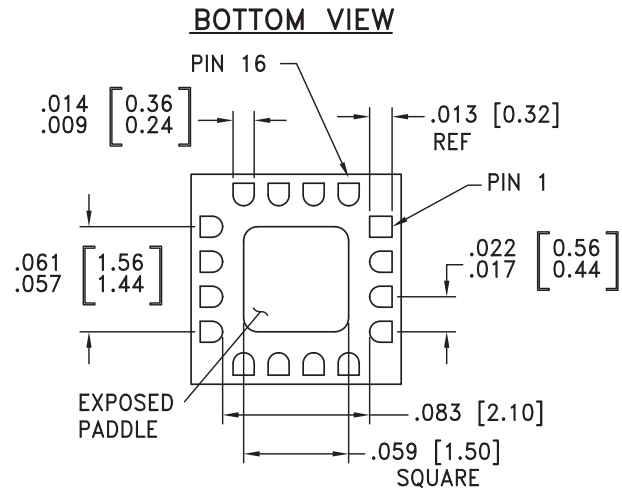
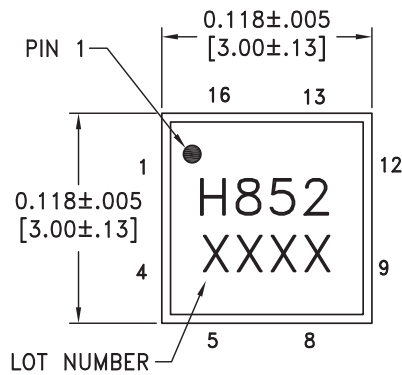



#### NOTES:

1. PACKAGE BODY MATERIAL: ALUMINA
2. LEAD AND GROUND PADDLE PLATING:  
30-80 MICROINCHES GOLD OVER 50 MICROINCHES MINIMUM NICKEL.
3. DIMENSIONS ARE IN INCHES [MILLIMETERS].
4. LEAD SPACING TOLERANCE IS NON-CUMULATIVE.
5. PACKAGE WARP SHALL NOT EXCEED 0.05mm DATUM -C-
6. ALL GROUND LEADS MUST BE SOLDERED TO PCB RF GROUND.
7. PADDLE MUST BE SOLDERED TO V<sub>ee</sub>.

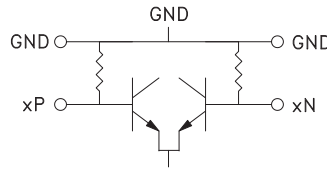
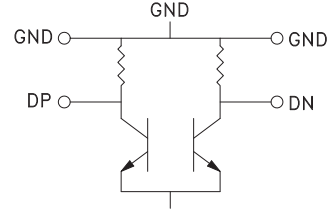

## 28 Gbps, AND / NAND / OR / NOR GATE WITH PROGRAMMABLE OUTPUT VOLTAGE

### Pin Descriptions

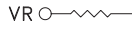
Pin Number	Function	Description	Interface Schematic
1, 4, 5, 8, 9, 12	GND	Signal Grounds	
2, 3 6, 7	AN, AP BN, BP	Differential Data Inputs: Current Mode Logic (CML) referenced to positive supply.	
10, 11	DP, DN	Differential Data Outputs: Current Mode Logic (CML) referenced to positive supply.	
13, 16	GND	Supply Ground	
14	VR	Output level control. Output level may be increased or decreased by applying a voltage to VR per "Output Differential vs. VR" plot.	
15, Package Base	Vee	This pin and the exposed paddle must be connected to the negative voltage supply.	

## 28 Gbps, AND / NAND / OR / NOR GATE WITH PROGRAMMABLE OUTPUT VOLTAGE

### Evaluation PCB

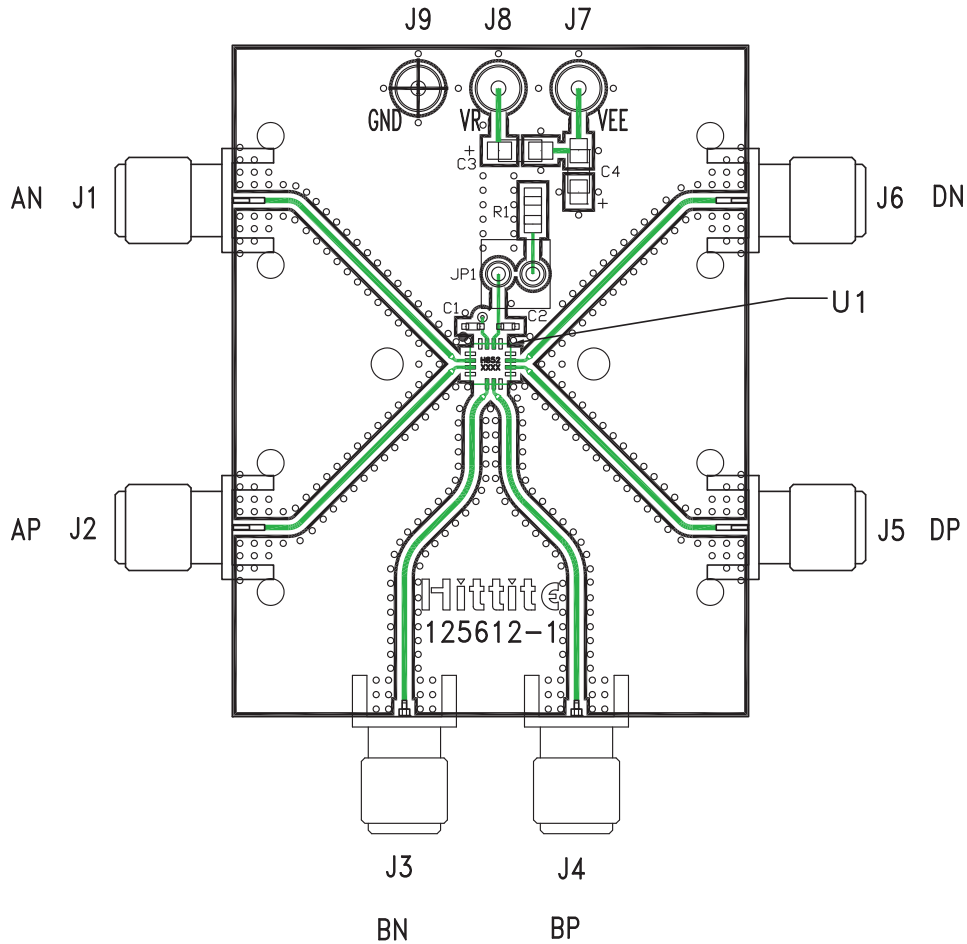

### List of Materials for Evaluation PCB 125614 [1]

Item	Description
J1 - J6	PCB Mount K RF Connectors
J7 - J9	DC Pin
JP1	0.1" Header with Shorting Jumper
C1, C2	100 pF Capacitor, 0402 Pkg.
C3, C4	4.7 μF Capacitor, Tantalum
R1	10 Ohm Resistor, 0603 Pkg.
U1	HMC852LC3C High Speed Logic, AND / NAND / OR / NOR Gate
PCB [2]	125612 Evaluation Board

[1] Reference this number when ordering complete evaluation PCB

[2] Circuit Board Material: Arlon 25FR or Rogers 4350

The circuit board used in the application should use RF circuit design techniques. Signal lines should have 50 Ohm impedance while the package ground leads should be connected directly to the ground plane similar to that shown. The exposed metal package base must be connected to Vee. A sufficient number of via holes should be used to connect the top and bottom ground planes. The evaluation circuit board shown is available from Hittite upon request. Install jumper on JP1 to short VR to GND for normal operation.



**28 Gbps, AND / NAND / OR / NOR GATE  
WITH PROGRAMMABLE OUTPUT VOLTAGE**
**Application Circuit**
