

阅读申明

- 1.本站收集的数据手册和产品资料都来自互联网，版权归原作者所有。如读者和版权方有任何异议请及时告之，我们将妥善解决。
- 2.本站提供的中文数据手册是英文数据手册的中文翻译，其目的是协助用户阅读，该译文无法自动跟随原稿更新，同时也可能存在翻译上的不当。建议读者以英文原稿为参考以便获得更精准的信息。
- 3.本站提供的产品资料，来自厂商的技术支持或者使用者的心得体会等，其内容可能存在描述上的差异，建议读者做出适当判断。
- 4.如需与我们联系，请发邮件到marketing@iczoom.com，主题请标有“数据手册”字样。

Read Statement

1. The datasheets and other product information on the site are all from network reference or other public materials, and the copyright belongs to the original author and original published source. If readers and copyright owners have any objections, please contact us and we will deal with it in a timely manner.
2. The Chinese datasheets provided on the website is a Chinese translation of the English datasheets. Its purpose is for reader's learning exchange only and do not involve commercial purposes. The translation cannot be automatically updated with the original manuscript, and there may also be improper translations. Readers are advised to use the English manuscript as a reference for more accurate information.
3. All product information provided on the website refer to solutions from manufacturers' technical support or users the contents may have differences in description, and readers are advised to take the original article as the standard.
4. If you have any questions, please contact us at marketing@iczoom.com and mark the subject with "Datasheets" .



VN5770AK-E

Quad smart power solid state relay for complete H-bridge configurations

Features

Type	$R_{DS(on)}$	I_{OUT}	V_{CC}
VN5770AK-E	280m Ω ⁽¹⁾	8.5A ⁽²⁾	36V

1. Total resistance of one side in bridge configuration
2. Typical current limitation value

■ General features

- Inrush current management by active power limitation on the high-side switches
- Very low standby current
- Very low electromagnetic susceptibility
- In compliance with the 2002/95/EC European directive

■ Protection

- High-side drivers undervoltage shutdown
- Overvoltage clamp
- Output current limitation
- High and low-side overtemperature shutdown
- Short circuit protection
- ESD protection

■ Diagnostic functions

- Proportional load current sense
- Thermal shutdown indication on both the high and low-side switches

Applications

- DC motor driving in full or half bridge configuration
- All types of resistive, inductive and capacitive loads

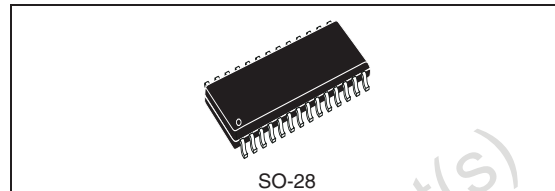

Description

The VN5770AK-E is a device formed by three monolithic chips housed in a standard SO-28 package: a double high-side and two low-side switches. The double high-side is made using STMicroelectronics® VIPower® M0-5 Technology, while the low-side switches are fully protected VIPower M0-3 OMNIFET II. This device is suitable to drive a DC motor in a bridge configuration as well as to be used as a quad switch for any low voltage application.

The dual high-side switches integrate built-in non-latching thermal shutdown with thermal hysteresis. An output current limiter protects the device in overload condition. In case of long overload duration, the device limits the dissipated power to a safe level up to thermal shut-down intervention. An analog current sense pin delivers a current proportional to the load current (according to a known ratio) and indicates overtemperature shutdown of the relevant high-side switch through a voltage flag.

The low-side switches have built-in non-latching thermal shutdown with thermal hysteresis, linear current limitation and overvoltage clamping.

Fault feedback for overtemperature shutdown of the low-side switch is indicated by the relevant input pin current consumption going up to the fault sink current flag.

Contents

1	Block diagram and pin descriptions	5
2	Absolute maximum ratings	7
2.1	Absolute maximum ratings	7
3	Electrical characteristics	9
3.1	Electrical characteristics for dual high-side switch	9
3.2	Electrical characteristics curves for dual high-side switch	13
3.3	Electrical characteristics for low-side switches	15
3.4	Electrical characteristics for low-side switches	17
4	Application information	20
4.1	Maximum demagnetization energy ($V_{CC} = 13.5V$)	23
5	Package and thermal data	24
5.1	SO-28 thermal data	24
6	Package and packing information	29
6.1	ECOPACK®	29
6.2	SO-28 package information	29
6.3	SO-28 packing information	31
7	Order codes	32
8	Revision history	33

List of tables

Table 1.	Pin descriptions	5
Table 2.	Thermal data	6
Table 3.	Dual high-side switch	7
Table 4.	Low-side switch	8
Table 5.	Power section	9
Table 6.	Switching ($V_{CC} = 13V$)	9
Table 7.	Logic input	10
Table 8.	Protection and diagnostics	10
Table 9.	Current sense ($8V < V_{CC} < 16V$)	11
Table 10.	Truth table	12
Table 11.	Off	15
Table 12.	On	15
Table 13.	Dynamic ($T_j = 25^\circ C$, unless otherwise specified)	15
Table 14.	Switching ($T_j = 25^\circ C$, unless otherwise specified)	15
Table 15.	Source drain diode	16
Table 16.	Protection and diagnostics ($-40^\circ C < T_j < 150^\circ C$, unless otherwise specified)	16
Table 17.	Thermal calculations in clockwise and anti-clockwise operation in steady-state mode	25
Table 18.	Thermal resistances definitions	25
Table 19.	Single pulse thermal impedance definitions	25
Table 20.	Thermal calculations in transient mode	25
Table 21.	Thermal parameters	27
Table 22.	SO-28 mechanical data	29
Table 23.	Device summary	32
Table 24.	Document revision history	33

List of figures

Figure 1.	Block diagram	5
Figure 2.	Configuration diagram (top view)	6
Figure 3.	Switching time waveforms	11
Figure 4.	Output voltage drop limitation	12
Figure 5.	Current sense delay characteristics	12
Figure 6.	Off-state output current	13
Figure 7.	High level input current	13
Figure 8.	Input clamp voltage	13
Figure 9.	Input low level	13
Figure 10.	Input high level	13
Figure 11.	Input hysteresis voltage	13
Figure 12.	On-state resistance vs T_{case}	14
Figure 13.	On-state resistance vs V_{CC}	14
Figure 14.	Undervoltage shutdown	14
Figure 15.	Turn-on voltage slope	14
Figure 16.	I_{LIMH} vs T_{case}	14
Figure 17.	Turn-off voltage slope	14
Figure 18.	Static drain source on resistance	17
Figure 19.	Derating curve	17
Figure 20.	Transconductance	17
Figure 21.	Transfer characteristics	17
Figure 22.	Input voltage vs input charge	17
Figure 23.	Capacitance variations	17
Figure 24.	Output characteristics	18
Figure 25.	Step response current limit	18
Figure 26.	Source-drain diode forward characteristics	18
Figure 27.	Static drain-source on resistance vs I_D	18
Figure 28.	Static drain-source on resistance vs input voltage (part 1)	18
Figure 29.	Static drain-source on resistance vs input voltage (part 2)	18
Figure 30.	Normalized input threshold voltage vs temperature	19
Figure 31.	Normalized on resistance vs temperature	19
Figure 32.	Current limit vs junction temperature	19
Figure 33.	Typical application schematic	20
Figure 34.	Recommended motor operation	21
Figure 35.	Waveforms	22
Figure 36.	Maximum turn off current versus load inductance	23
Figure 37.	SO-28 PC board	24
Figure 38.	Chipset configuration	24
Figure 39.	Auto and mutual $R_{thj-amb}$ vs PCB copper area in open box free air condition	24
Figure 40.	SO-28 HSD thermal impedance junction ambient single pulse	26
Figure 41.	SO-28 LSD thermal impedance junction ambient single pulse	26
Figure 42.	Thermal fitting model of an H-Bridge in SO-28	27
Figure 43.	SO-28 package dimensions	30
Figure 44.	SO-28 tube shipment (no suffix)	31
Figure 45.	Tape and reel shipment (suffix "TR")	31

1 Block diagram and pin descriptions

Figure 1. Block diagram

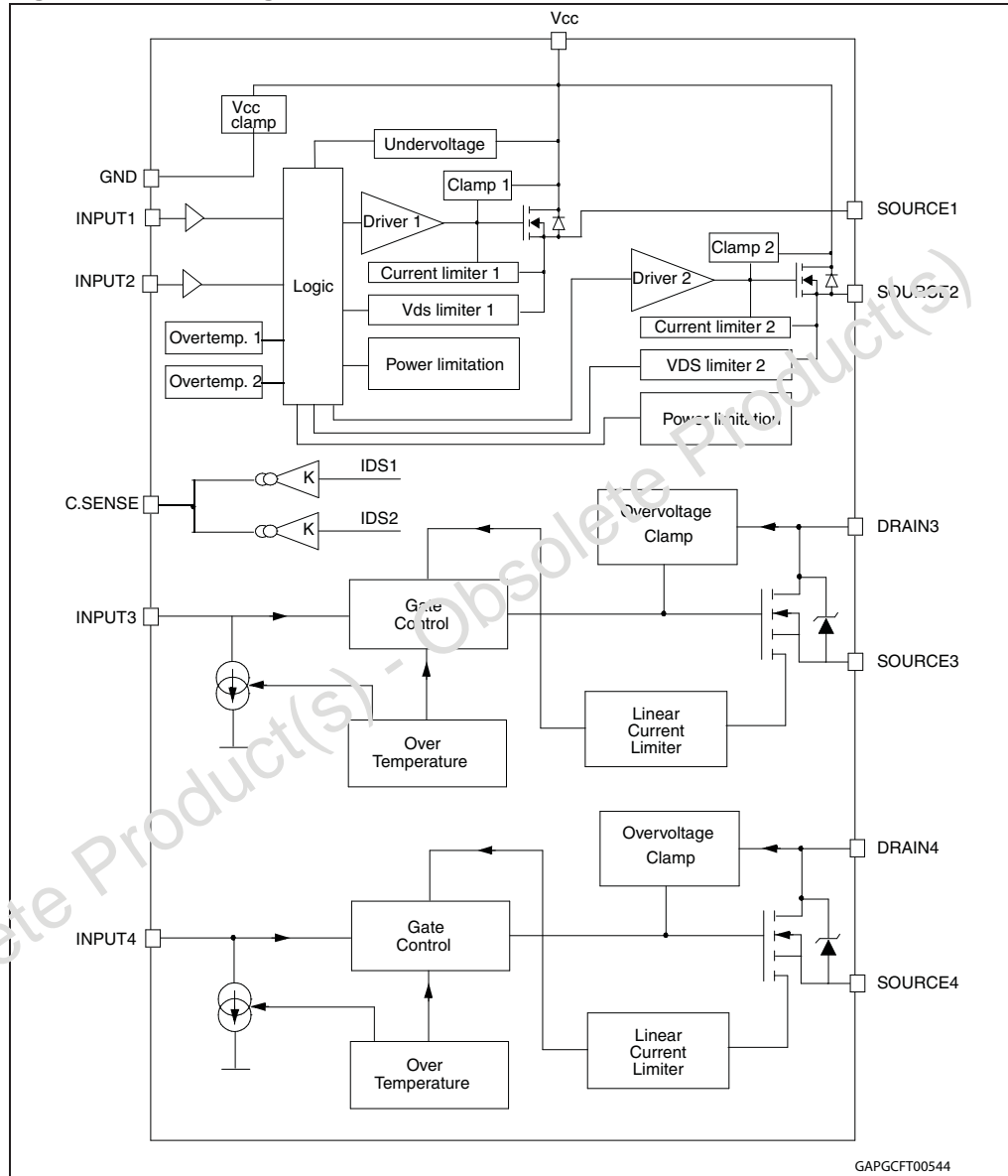
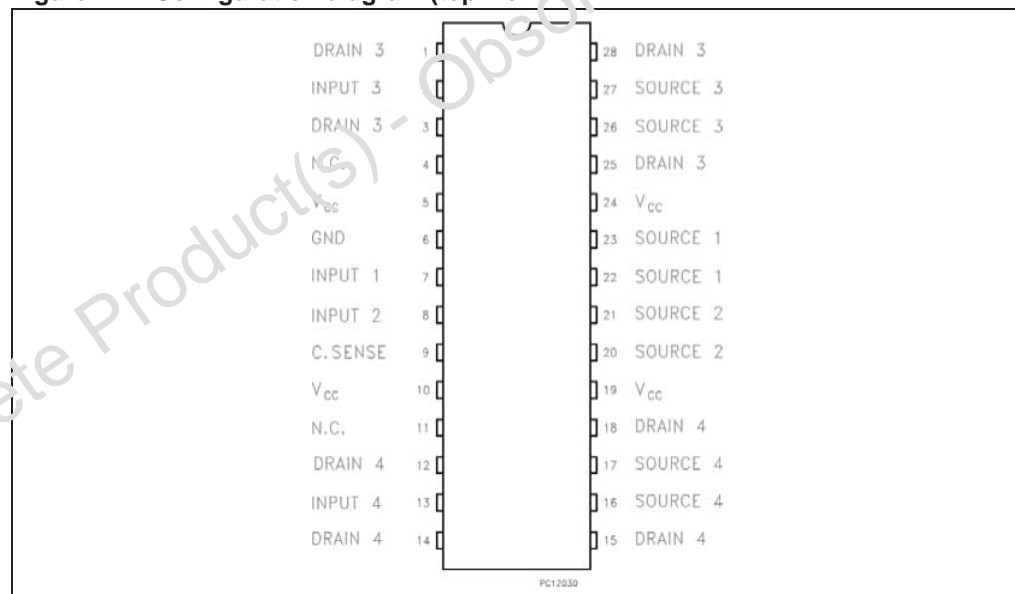

Table 1. Pin descriptions

No	Name	Function
1, 3, 25, 28	DRAIN 3	Drain of Switch 3 (low-side switch)
2	INPUT 3	Input of Switch 3 (low-side switch)
4, 11	N.C.	Not Connected

Table 1. Pin descriptions (continued)

No	Name	Function
5, 10, 19, 24	V _{CC}	Drain of Switches 1 and 2 (high-side switches) and Power Supply Voltage
6	GND	Ground of Switches 1 and 2 (high-side switches)
7	INPUT 1	Input of Switch 1 (high-side switches)
8	INPUT 2	Input of Switch 2 (high-side switch)
9	CURRENT SENSE	Analog current sense pin, it delivers a current proportional to the load current
12, 14, 15, 18	DRAIN 4	Drain of switch 4 (low-side switch)
13	INPUT 4	Input of Switch 4 (low-side switch)
16, 17	SOURCE 4	Source of Switch 4 (low-side switch)
20, 21	SOURCE 2	Source of Switch 2 (high-side switch)
22, 23	SOURCE 1	Source of Switch 1 (high-side switch)
26, 27	SOURCE 3	Source of Switch 3 (low-side switch)

Figure 2. Configuration diagram (top view)**Table 2. Thermal data**

Symbol	Parameter	Max value	Unit
R _{thj-case}	Thermal resistance junction-lead (high-side switch)	10	°C/W
R _{thj-case}	Thermal resistance junction-lead (low-side switch)	7	°C/W
R _{thj-amb}	Thermal resistance junction-ambient	See Figure 39	°C/W

2 Absolute maximum ratings

Stressing the device above the rating listed in [Table 3](#) and [Table 4](#) may cause permanent damage to the device. These are stress ratings only and operation of the device at these or any other conditions above those indicated in the Operating sections of this specification is not implied. Exposure to the conditions in [Section 2.1: Absolute maximum ratings](#) for extended periods may affect device reliability.

2.1 Absolute maximum ratings

Table 3. Dual high-side switch

Symbol	Parameter	Value	Unit
V_{CC}	DC supply voltage	41	V
$-V_{CC}$	Reverse DC supply voltage	0.3	V
$-I_{GND}$	DC reverse ground pin current	200	mA
I_{OUT}	DC output current	Internally limited	A
$-I_{OUT}$	Reverse DC output current	-12	A
I_{IN}	DC input current	-1 to 10	mA
I_{CSD}	DC current sense disable input current	-1 to 10	mA
V_{CSENSE}	Current sense maximum voltage	$V_{CC}-41$ $+V_{CC}$	V V
E_{MAX}	Maximum switching energy (single pulse) ($L = 3.7\text{mH}$; $R_L = 0\Omega$; $V_{bat} = 13.5\text{V}$; $T_{jstart} = 150^\circ\text{C}$; $I_{OUT} = I_{lim}(\text{typ.})$)	32	mJ
V_{ESD}	Electrostatic Discharge (Human Body Model: $R = 1.5\text{K}\Omega$; $C = 100\text{pF}$) - INPUT - CURRENT SENSE - OUTPUT - V_{CC}	4000 2000 5000 5000	V V V V
V_{ESD}	Charge device model (CDM-AEC-Q100-011)	750	V
T_j	Junction operating temperature	-40 to 150	$^\circ\text{C}$
T_{stg}	Storage temperature	-55 to 150	$^\circ\text{C}$

Table 4. Low-side switch

Symbol	Parameter	Value	Unit
V_{DSn}	Drain-source voltage ($V_{INn} = 0V$)	Internally clamped	V
V_{INn}	Input voltage	Internally clamped	V
I_{INn}	Input current	+/-20	mA
$R_{IN MINn}$	Minimum input series impedance	220	Ω
I_{Dn}	Drain current	Internally limited	A
I_{Rn}	Reverse DC output current	-12	A
V_{ESD1}	Electrostatic discharge ($R = 1.5K\Omega$, $C = 100pF$)	4000	V
V_{ESD2}	Electrostatic discharge on output pins only ($R = 330\Omega$, $C = 150pF$)	16500	V
P_{tot}	Total dissipation at $T_c = 25^\circ C$	4	W
T_j	Operating junction temperature	Internally limited	$^\circ C$
T_c	Case operating temperature	Internally limited	$^\circ C$
T_{stg}	Storage temperature	-55 to 150	$^\circ C$

3 Electrical characteristics

3.1 Electrical characteristics for dual high-side switch

Values specified in this section are for $8V < V_{CC} < 36V$; $-40^{\circ}C < T_j < 150^{\circ}C$, unless otherwise specified (for each channel).

Table 5. Power section

Symbol	Parameter	Test conditions	Min.	Typ.	Max.	Unit
V_{CC}	Operating supply voltage		4.5	13	36	V
V_{USD}	Undervoltage shutdown			3.5	4.5	V
$V_{USDhyst}$	Undervoltage shutdown hysteresis			0.5		V
R_{ON}	On state resistance	$I_{OUT} = 3A$; $T_j = 25^{\circ}C$			160	m Ω
		$I_{OUT} = 3A$; $T_j = 150^{\circ}C$			320	m Ω
		$I_{OUT} = 3A$; $V_{CC} = 5V$; $T_j = 25^{\circ}C$			210	m Ω
V_{clamp}	Clamp voltage	$I_S = 20\text{ mA}$	41	46	52	V
I_S	Supply current	Off State; $V_{CC} = 13V$; $T_j = 25^{\circ}C$; $V_{IN} = V_{OUT} = V_{SENSE} = 0V$		2 ⁽¹⁾	5 ⁽¹⁾	μA
		On State; $V_{CC} = 13V$; $V_{IN} = 5V$; $I_{OUT} = 0A$		3	6	mA
$I_{L(off)}$	Off state output current ⁽²⁾	$V_{IN} = V_{OUT} = 0V$; $V_{CC} = 13V$; $T_j = 25^{\circ}C$	0		3	μA
		$V_{IN} = V_{OUT} = 0V$; $V_{CC} = 13V$; $T_j = 125^{\circ}C$	0		5	μA
V_F	Output - V_{CC} diode voltage ⁽²⁾	$-I_{OUT} = 3A$; $T_j = 150^{\circ}C$			0.7	V

1. PowerMOS leakage included

2. For each channel

Table 6. Switching ($V_{CC} = 13V$)

Symbol	Parameter	Test conditions	Min.	Typ.	Max.	Unit
$t_{d(on)}$	Turn-on delay time	$R_L = 4.3\Omega$ (see Figure 3)	—	15	—	μs
$t_{d(off)}$	Turn-off delay time	$R_L = 4.3\Omega$ (see Figure 3)	—	10	—	μs
$(dV_{OUT}/dt)_{on}$	Turn-on voltage slope	$R_L = 4.3\Omega$	—	See Figure 15	—	V/ μs
$(dV_{OUT}/dt)_{off}$	Turn-off voltage slope	$R_L = 4.3\Omega$	—	See Figure 17	—	V/ μs
W_{ON}	Switching energy losses during t_{won}	$R_L = 4.3\Omega$ (see Figure 3)	—	0.16	—	mJ
W_{OFF}	Switching energy losses during t_{woff}	$R_L = 4.3\Omega$ (see Figure 3)	—	0.08	—	mJ

Table 7. Logic input

Symbol	Parameter	Test conditions	Min.	Typ.	Max.	Unit
V_{IL}	Input low level voltage				0.9	V
I_{IL}	Low level input current	$V_{IN} = 0.9V$	1			μA
V_{IH}	Input high level voltage		2.1			V
I_{IH}	High level input current	$V_{IN} = 2.1V$			10	μA
$V_{I(hyst)}$	Input hysteresis voltage		0.25			V
V_{ICL}	Input clamp voltage	$I_{IN} = 1mA$	5.5		7	V
		$I_{IN} = -1mA$		-0.7		V

Table 8. Protection and diagnostics⁽¹⁾

Symbol	Parameter	Test conditions	Min.	Typ.	Max.	Unit
I_{limH}	DC Short circuit current	$V_{CC} = 13V$	6	8.5	12	A
		$5V < V_{CC} < 36V$			12	A
I_{limL}	Short circuit current during thermal cycling	$V_{CC} = 13V; T_R < T_j < T_{TSD}$		3.5		A
T_{TSD}	Shutdown temperature		150	175	200	$^{\circ}C$
T_R	Reset temperature		$T_{RS} + 1$	$T_{RS} + 5$		$^{\circ}C$
T_{RS}	Thermal reset of STATUS		135			$^{\circ}C$
T_{HYST}	Thermal hysteresis ($T_{TSD} - T_R$)			7		$^{\circ}C$
V_{DEMAG}	Turn-off output voltage clamp	$I_{OUT} = 1A; V_{IN} = 0; L = 20mH$	$V_{CC} - 41$	$V_{CC} - 46$	$V_{CC} - 52$	V
V_{ON}	Output voltage drop limitation	$I_{OUT} = 0.03A;$ $T_j = -40^{\circ}C$ to $150^{\circ}C$ (see Figure 4)		25		mV

1. To ensure long term reliability under heavy overload or short circuit conditions, protection and related diagnostic signals must be used together with a proper software strategy. If the device is subjected to abnormal conditions, this software must limit the duration and number of activation cycles

Table 9. Current sense (8V<V_{CC}<16V)

Symbol	Parameter	Test conditions	Min.	Typ.	Max.	Unit
K ₀	I _{OUT} /I _{SENSE}	I _{OUT} = 0.08 A; V _{SENSE} = 0.5 V; T _j = -40°C to 150°C	1266	1900	3100	
K ₁	I _{OUT} /I _{SENSE}	I _{OUT} = 0.35 A; V _{SENSE} = 0.5V; T _j = -40°C to 150°C T _j = 25°C to 150°C	840 980	1360 1360	2000 1740	
K ₂	I _{OUT} /I _{SENSE}	I _{OUT} = 3A; V _{SENSE} = 4V; T _j = -40°C to 150°C	1200	1270	1350	
K ₃	I _{OUT} /I _{SENSE}	I _{OUT} = 4A; V _{SENSE} = 4V; T _j = -40°C to 150°C	1200	1270	1350	
I _{SENSE0}	Analog sense current	I _{OUT} = 0A; V _{SENSE} = 0V; V _{IN} = 0V; T _j = -40°C to 150°C	0	1		μA
		I _{OUT} = 0A; V _{SENSE} = 0V; V _{IN} = 5V; T _j = -40°C to 150°C	0		2	μA
V _{SENSE}	Max analog sense output voltage	I _{OUT} = 5A; R _{SENSE} = 3.9KΩ	5			V
V _{SENSEH}	Analog sense output voltage in overtemperature condition	V _{CC} = 13V; R _{SENSE} = 3.9KΩ		9		V
I _{SENSEH}	Analog sense output current in overtemperature condition	V _{CC} = 13V		8		mA
t _{DSENSE2H}	Delay response time from rising edge of INPUT pin	V _{SENSE} < 4V; 0.35A < I _{out} < 5A; I _{SENSE} = 90% of I _{SENSE} max (see Figure 5)		70	300	μs
t _{DSENSE2L}	Delay response time from falling edge of INPUT pin	V _{SENSE} < 4V; 0.35A < I _{out} < 5A; I _{SENSE} = 10% of I _{SENSE} max (see Figure 5)		100	250	μs

Figure 3. Switching time waveforms

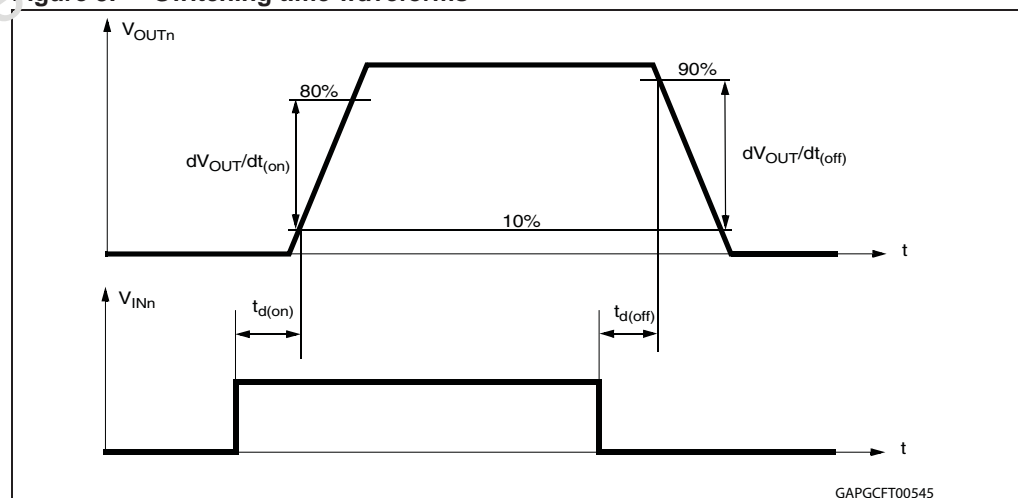

Figure 4. Output voltage drop limitation

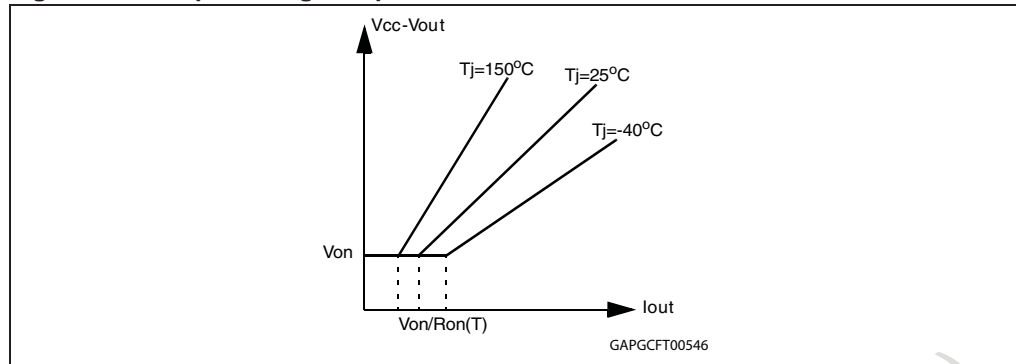
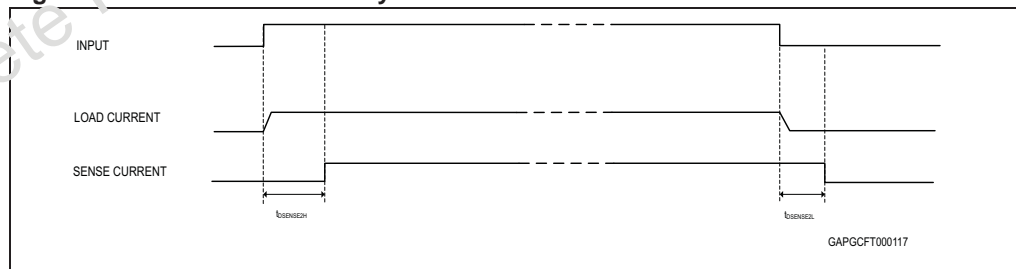

Table 10. Truth table

Conditions	Input	Output	Sense
Normal operation	L	L	0
	H	H	Nominal
Overtemperature	L	L	0
	H	L	V_{SENSEH}
Undervoltage	L	L	0
	H	L	0
Short circuit to GND	L	L	0
	H	L	0
Short circuit to V_{CC}	L	H	0
	H	H	< Nominal
Negative output voltage clamp	L	L	0

Figure 5. Current sense delay characteristics



3.2 Electrical characteristics curves for dual high-side switch

Figure 6. Off-state output current

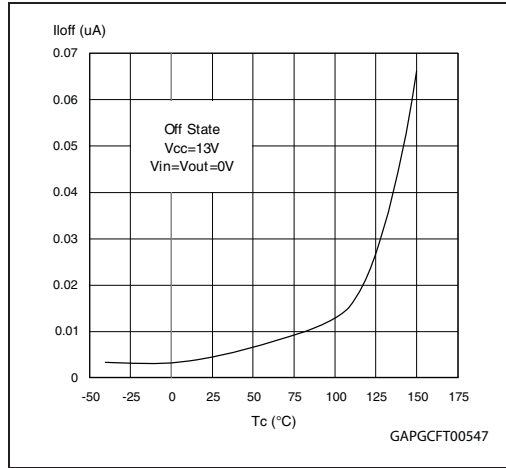

Figure 7. High level input current

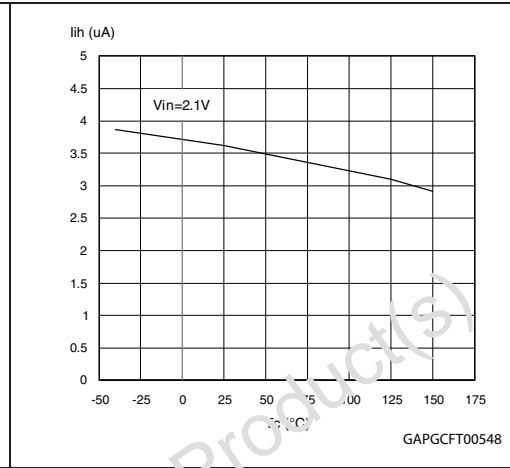

Figure 8. Input clamp voltage

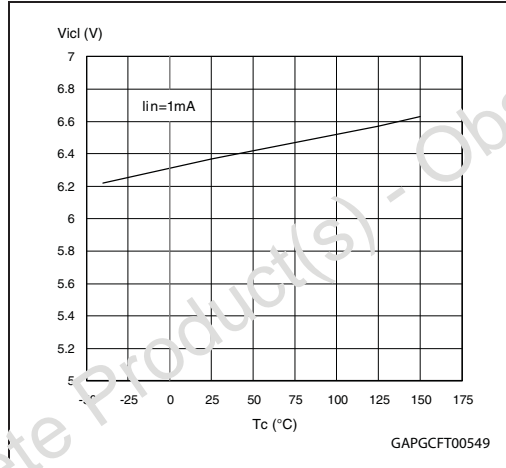

Figure 9. Input low level

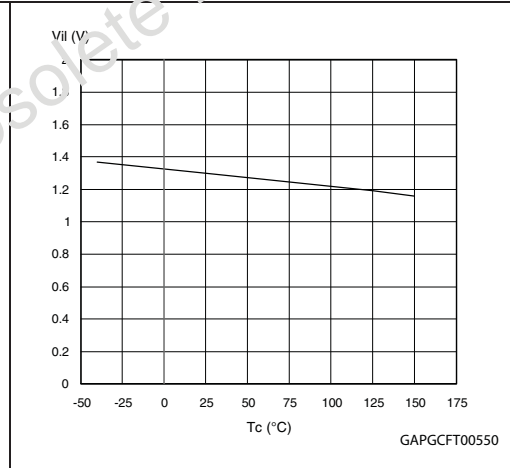

Figure 10. Input high level

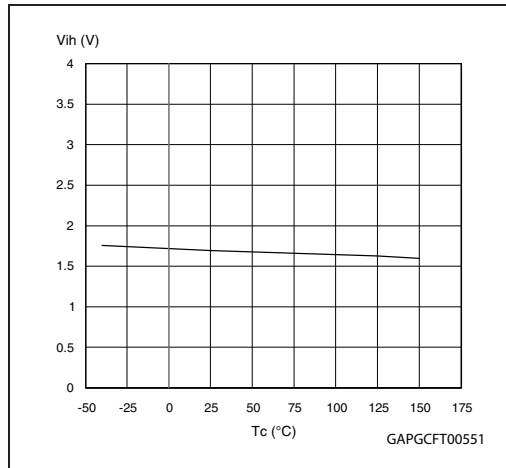

Figure 11. Input hysteresis voltage

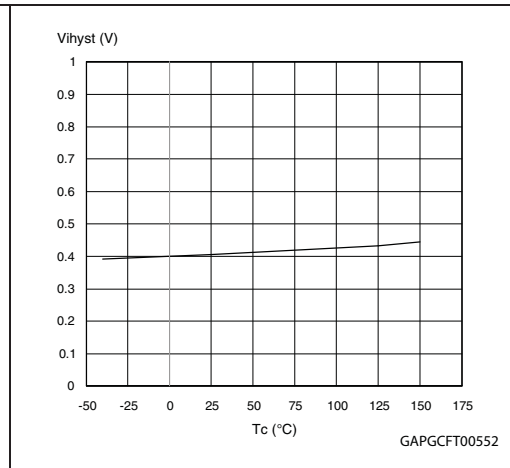

Figure 12. On-state resistance vs T_{case}

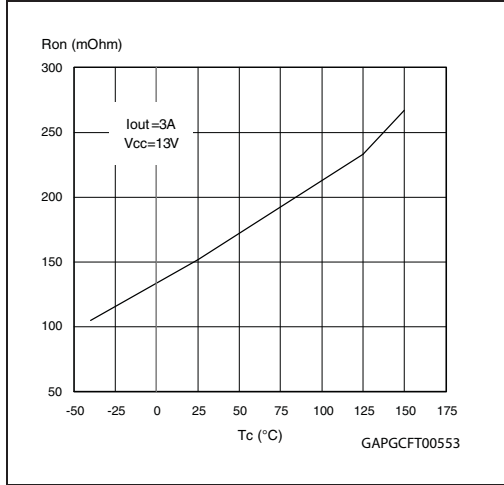

Figure 13. On-state resistance vs V_{CC}

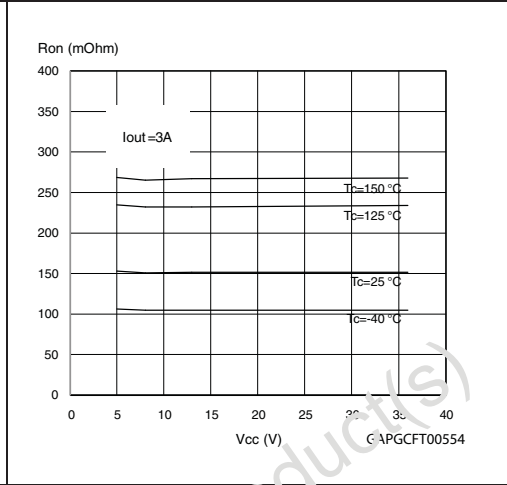

Figure 14. Undervoltage shutdown

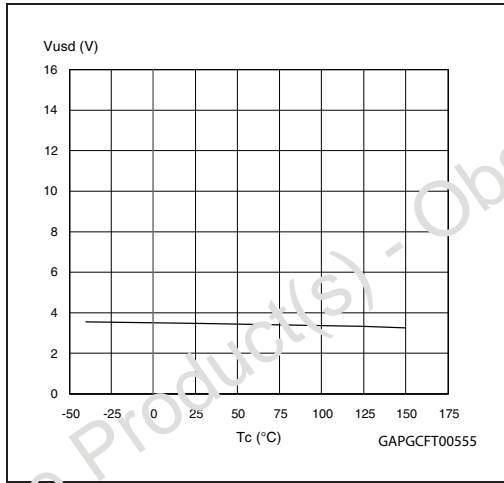

Figure 15. Turn-on voltage slope

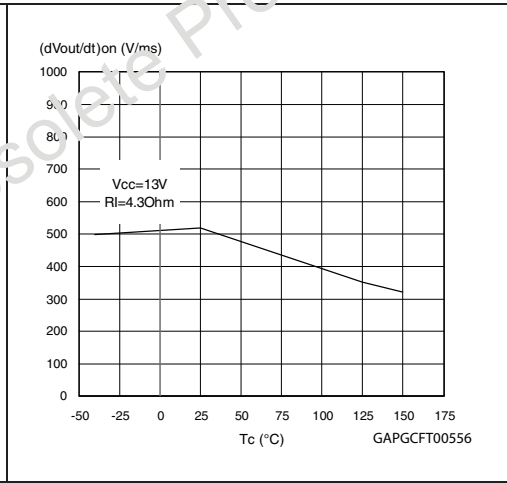

Figure 16. I_{LIMH} vs T_{case}

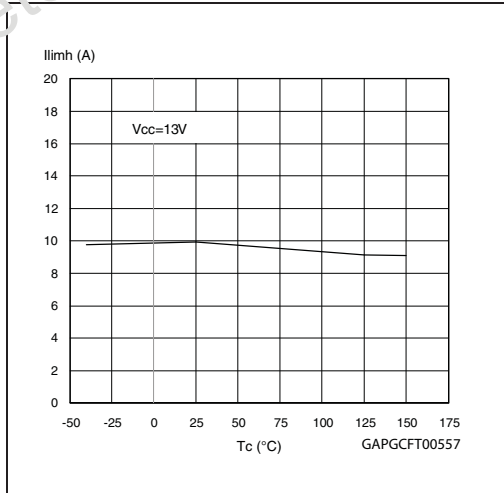
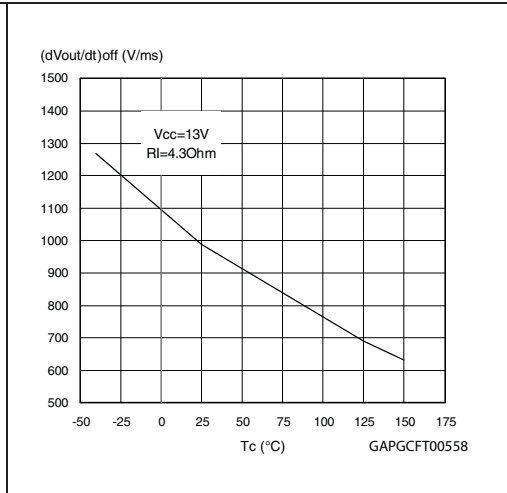

Figure 17. Turn-off voltage slope



3.3 Electrical characteristics for low-side switches

Values specified in this section are for $-40^{\circ}\text{C} < T_j < 150^{\circ}\text{C}$, unless otherwise specified

Table 11. Off

Symbol	Parameter	Test conditions	Min	Typ	Max	Unit
V_{CLAMP}	Drain-source clamp voltage	$V_{\text{IN}}=0\text{V}; I_{\text{D}} = 1.5\text{A}$	40	45	55	V
V_{CLTH}	Drain-source clamp threshold voltage	$V_{\text{IN}} = 0\text{V}; I_{\text{D}} = 2\text{mA}$	36			V
V_{INTH}	Input threshold voltage	$V_{\text{DS}} = V_{\text{IN}}; I_{\text{D}} = 1\text{mA}$	0.5		2.5	V
I_{ISS}	Supply current from input pin	$V_{\text{DS}}=0\text{V}; V_{\text{IN}} = 5\text{V}$		100	150	μA
V_{INCL}	Input-source clamp voltage	$I_{\text{IN}} = 1\text{mA}$	6	6.8	3	V
		$I_{\text{IN}} = -1\text{mA}$	-1.0		-0.3	V
I_{DSS}	Zero input voltage drain current ($V_{\text{IN}} = 0\text{V}$)	$V_{\text{DS}} = 13\text{V}; V_{\text{IN}} = 0\text{V}; T_j = 25^{\circ}\text{C}$			30	μA
		$V_{\text{DS}} = 25\text{V}; V_{\text{IN}} = 0\text{V}$			75	μA

Table 12. On

Symbol	Parameter	Test conditions	Min	Typ	Max	Unit
$R_{\text{DS(on)}}$	Static drain-source on resistance	$V_{\text{IN}} = 0\text{V}; I_{\text{D}} = 3\text{A}; T_j = 25^{\circ}\text{C}$	—	—	120	$\text{m}\Omega$
		$V_{\text{IN}} = 5\text{V}; I_{\text{D}} = 3\text{A}$	—	—	240	$\text{m}\Omega$

Table 13. Dynamic ($T_j = 25^{\circ}\text{C}$, unless otherwise specified)

Symbol	Parameter	Test conditions	Min	Typ	Max	Unit
g_{fe}	Forward transconductance	$V_{\text{DD}} = 13\text{V}; I_{\text{D}} = 1.5\text{A}$	—	2.5	—	S
C_{OSS}	Output capacitance	$V_{\text{DS}} = 13\text{V}; f = 1\text{MHz}; V_{\text{IN}} = 0\text{V}$	—	150	—	pF

Table 14. Switching ($T_j = 25^{\circ}\text{C}$, unless otherwise specified)

Symbol	Parameter	Test conditions	Min	Typ	Max	Unit
$t_{\text{d(on)}}$	Turn-on delay time	$V_{\text{DD}} = 15\text{V}; I_{\text{D}} = 3\text{A}; V_{\text{gen}} = 5\text{V}; R_{\text{gen}} = R_{\text{IN MIN}} = 220\Omega$	—	200	400	ns
t_{r}	Rise time		—	1.2	2.5	μs
$t_{\text{d(off)}}$	Turn-off delay time		—	600	1350	ns
t_{f}	Fall time		—	400	1000	ns
$t_{\text{d(on)}}$	Turn-on delay time	$V_{\text{DD}} = 15\text{V}; I_{\text{D}} = 3\text{A}; V_{\text{gen}} = 5\text{V}; R_{\text{gen}} = 2.2\text{K}\Omega$	—	0.80	2.5	μs
t_{r}	Rise time		—	3.7	7.5	μs
$t_{\text{d(off)}}$	Turn-off delay time		—	2.6	7.5	μs
t_{f}	Fall time		—	2.3	7.0	μs

Table 14. Switching ($T_j = 25^\circ\text{C}$, unless otherwise specified) (continued)

Symbol	Parameter	Test conditions	Min	Typ	Max	Unit
$(di/dt)_{on}$	Turn-on current slope	$V_{DD} = 15\text{V}; I_D = 3\text{A}; V_{gen} = 5\text{V}; R_{gen} = R_{IN\ MINn} = 220\Omega$	—	3.0		$\text{A}/\mu\text{s}$
Q_i	Total input charge	$V_{DD} = 12\text{V}; I_D = 3\text{A}; V_{IN} = 5\text{V}; I_{gen} = 2.13\text{mA}$	—	9.0		nC

Table 15. Source drain diode

Symbol	Parameter	Test conditions	Min	Typ	Max	Unit
$V_{SD}^{(1)}$	Forward on voltage	$I_{SD}=1.5\text{A}; V_{IN}=0\text{V}$	—	0.8	—	V
t_{rr}	Reverse recovery time	$I_{SD}=1.5\text{A}; di/dt=12\text{A/ms}; V_{DD}=30\text{V}; L=200\mu\text{H}$	—	400	—	ns
Q_{rr}	Reverse recovery charge		—	200	—	nC
I_{RRM}	Reverse recovery current		—	1.0	—	A

1. Pulsed: pulse duration = 300 μs , duty cycle 1.5%

Table 16. Protection and diagnostics ($-40^\circ\text{C} < T_j < 150^\circ\text{C}$, unless otherwise specified)

Symbol	Parameter	Test conditions	Min	Typ	Max	Unit
I_{lim}	Drain current limit	$V_{IN}=5\text{V}; V_{DS}=13\text{V}$	6	8.5	12	A
t_{dlim}	Step response current limit	$V_{IN} = 5\text{V}; V_{DS}=13\text{V}$		10		μs
T_{jsh}	Overtemperature shutdown		150	175	200	$^\circ\text{C}$
T_{jrs}	Overtemperature reset		135			$^\circ\text{C}$
I_{gf}	Fault sink current	$V_{IN} = 5\text{V}; V_{DS} = 13\text{V}; T_j = T_{jsh}$	10	15	20	mA
E_{as}	Single pulse avalanche energy	Starting $T_j = 25^\circ\text{C}; V_{DD} = 24\text{V}; V_{IN} = 5\text{V}; R_{gen} = R_{IN\ MINn} = 220\Omega; L = 24\text{mH}$	100			mJ

3.4 Electrical characteristics for low-side switches

Figure 18. Static drain source on resistance

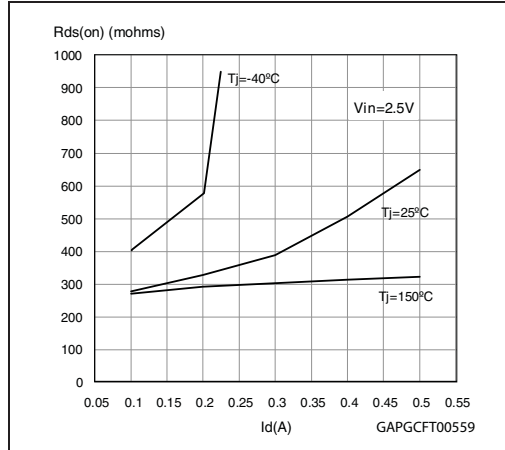

Figure 19. Derating curve

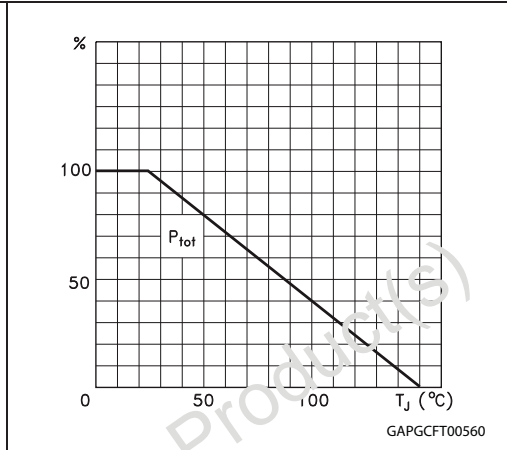

Figure 20. Transconductance

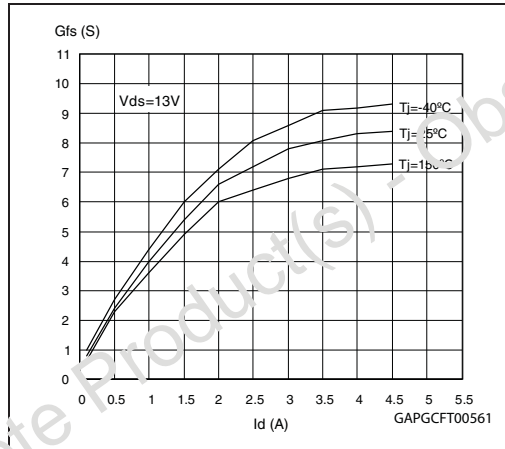

Figure 21. Transfer characteristics

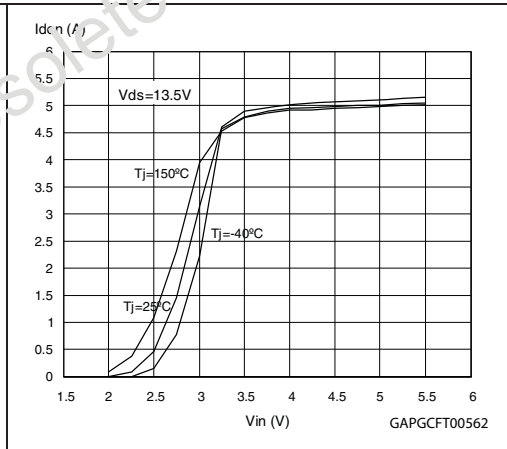

Figure 22. Input voltage vs input charge

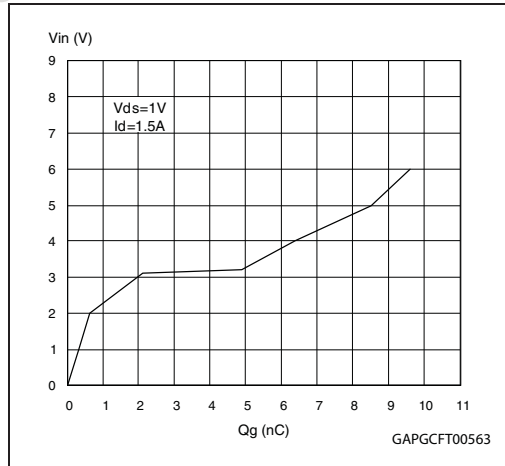

Figure 23. Capacitance variations

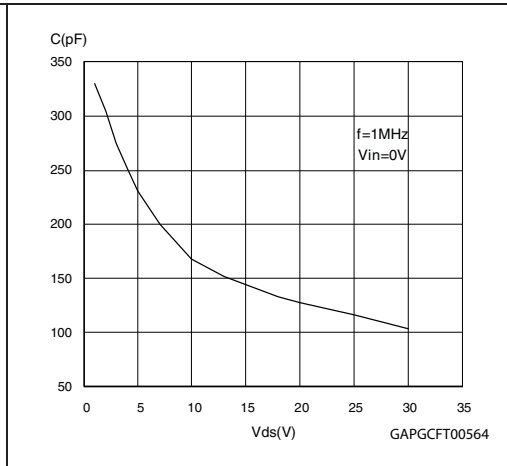

Figure 24. Output characteristics

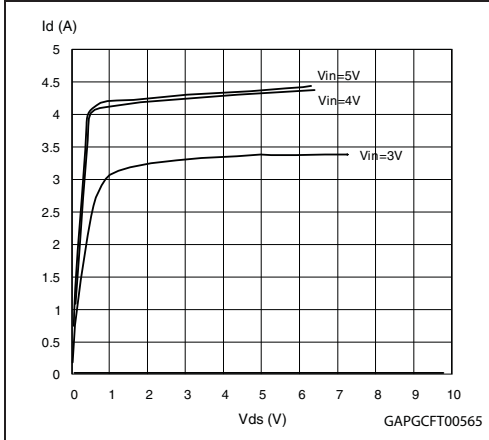

Figure 25. Step response current limit

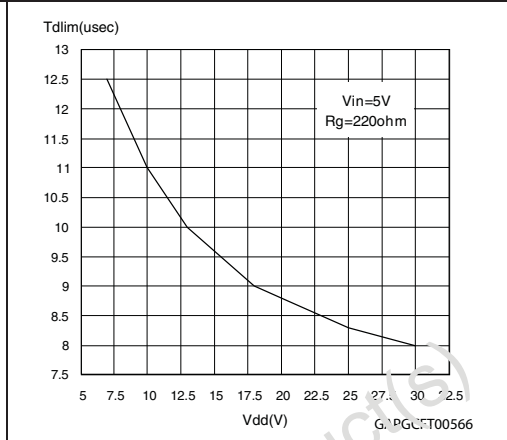

Figure 26. Source-drain diode forward characteristics

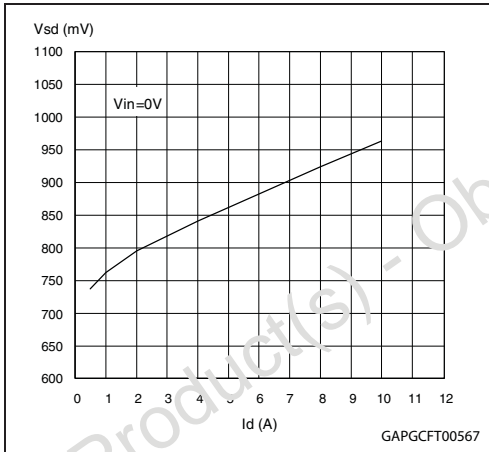

Figure 27. Static drain-source on resistance vs Id

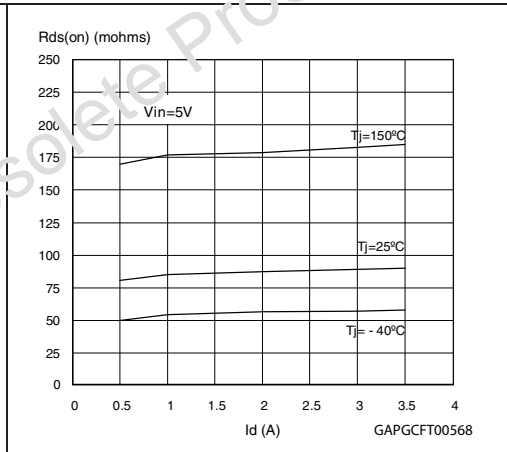

Figure 28. Static drain-source on resistance vs input voltage (part 1)

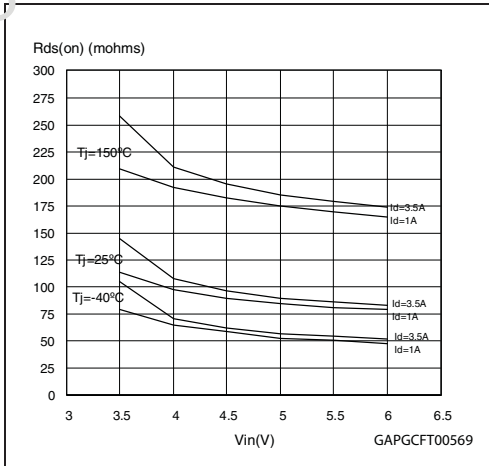

Figure 29. Static drain-source on resistance vs input voltage (part 2)

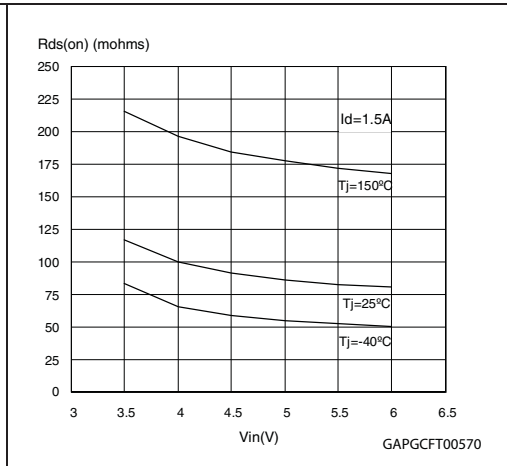

Figure 30. Normalized input threshold voltage vs temperature

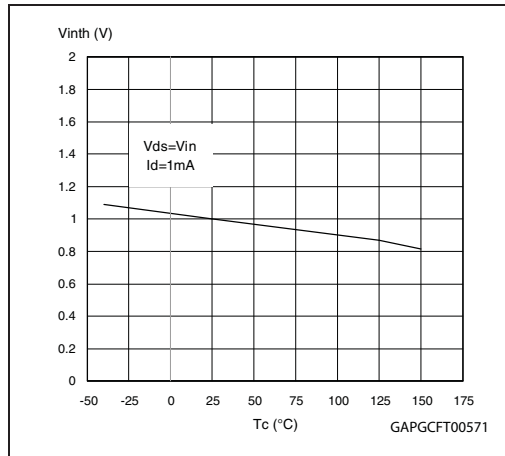

Figure 31. Normalized on resistance vs temperature

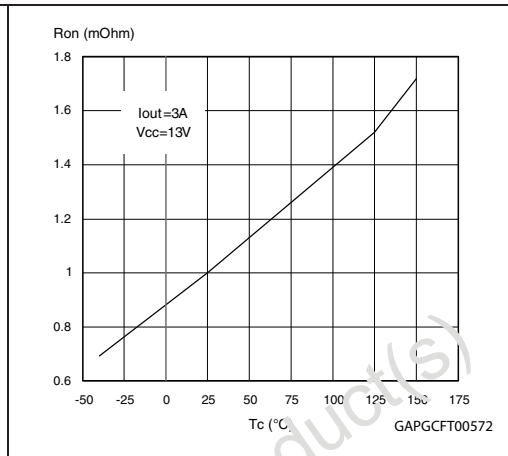
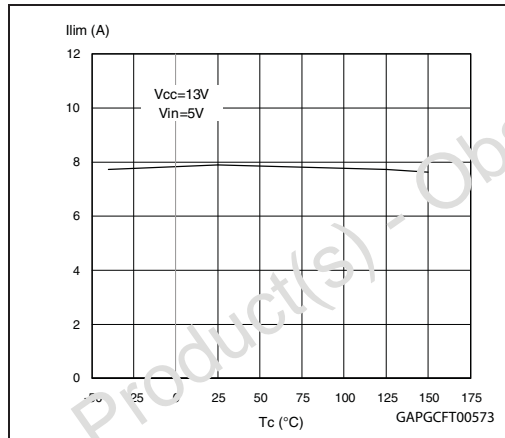

Figure 32. Current limit vs junction temperature



Obsolete Product(s) - Obsolete Product(s)

4 Application information

Figure 33. Typical application schematic

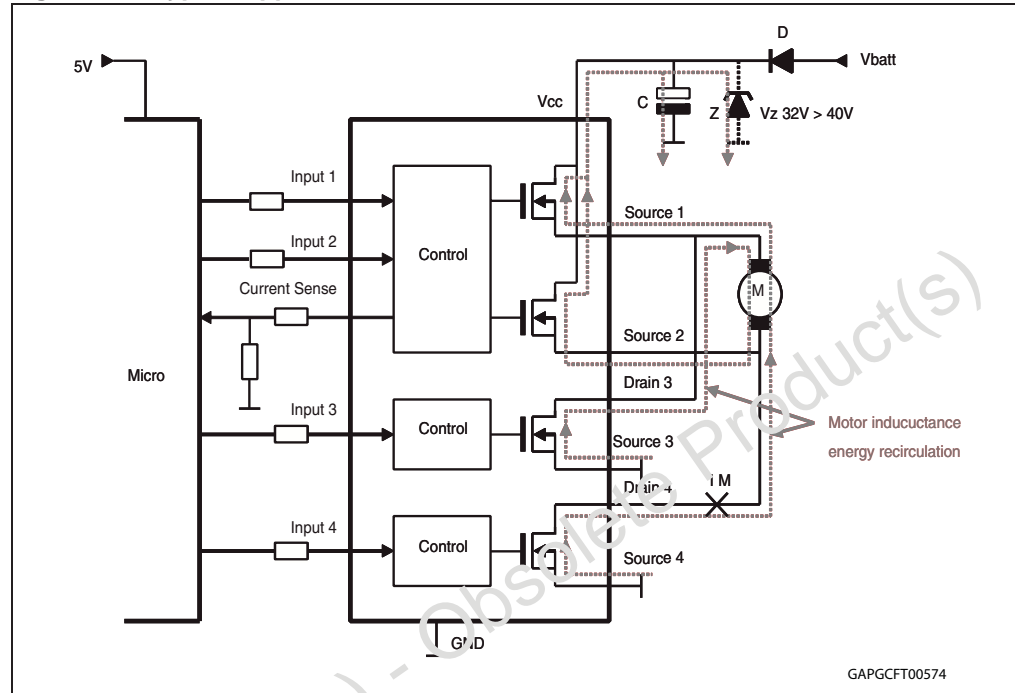

Note: Mostly motor bridge drivers use a reverse battery protection diode (D) inside supply rail. This diode prevents a reverse current flow back to Vbatt in case the bridge gets disabled via the logic inputs while motor inductance still carries energy. In order to prevent a hazardous overvoltage at circuit supply terminal (Vcc), a blocking capacitor (C) is needed to limit the voltage overshoot. As basic orientation, 50µF per 1A load current is recommended. In alternative, also a Zener protection (Z) is suitable. Even if a reverse polarity diode is not present, it is recommended to use a capacitor or zener at Vcc because a similar problem appears in case supply terminal of the module has intermittent electrical contact to the battery or gets disconnected while motor is operating.

Figure 34. Recommended motor operation

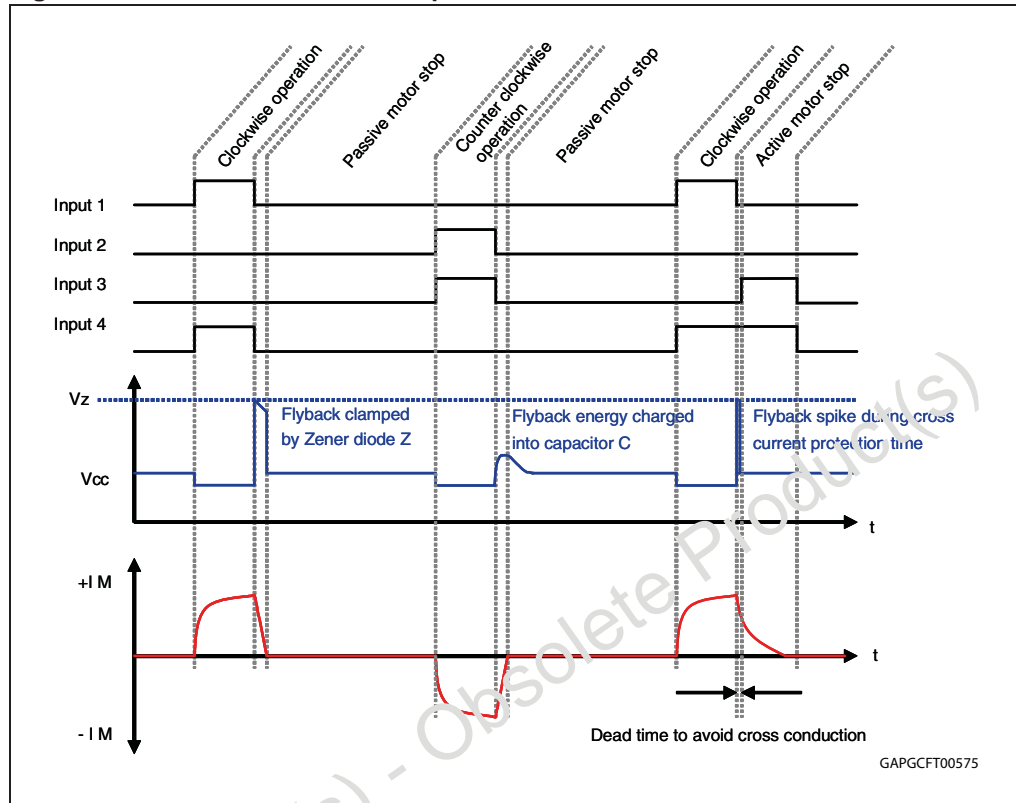
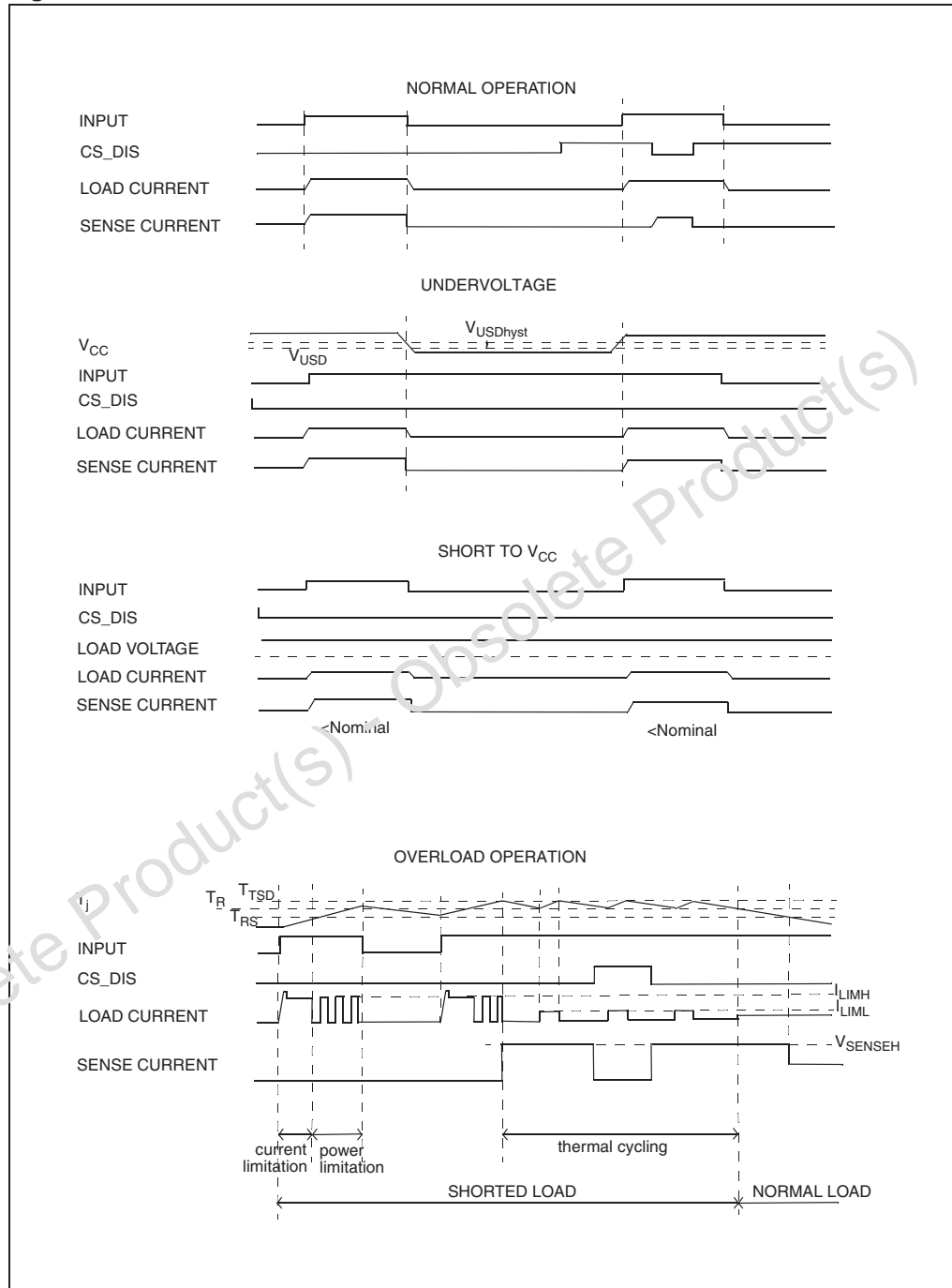
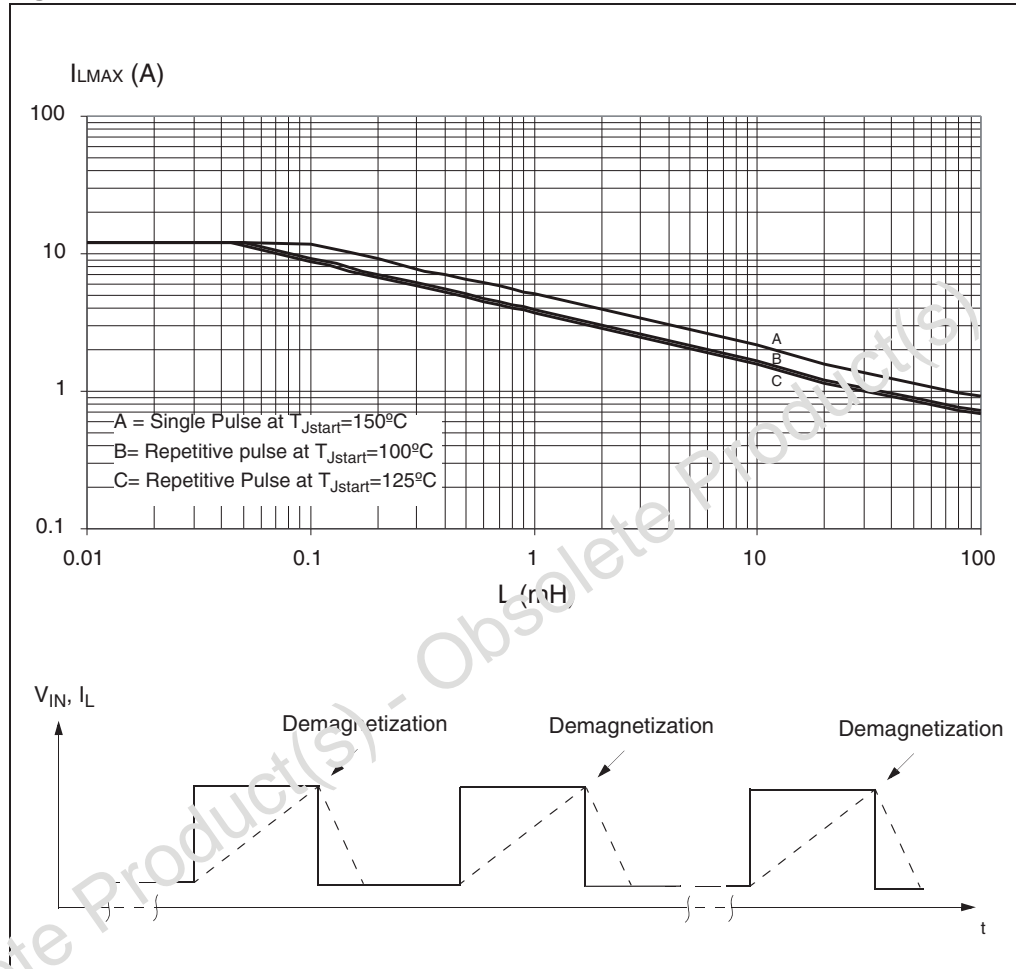

Figure 35. Waveforms



4.1 Maximum demagnetization energy ($V_{CC} = 13.5V$)

Figure 36. Maximum turn off current versus load inductance



Note: Values are generated with $R_L=0\Omega$

In case of repetitive pulses, T_{Jstart} (at the beginning of each demagnetization) of every pulse must not exceed the temperature specified above for curves B and C.

5 Package and thermal data

5.1 SO-28 thermal data

Figure 37. SO-28 PC board

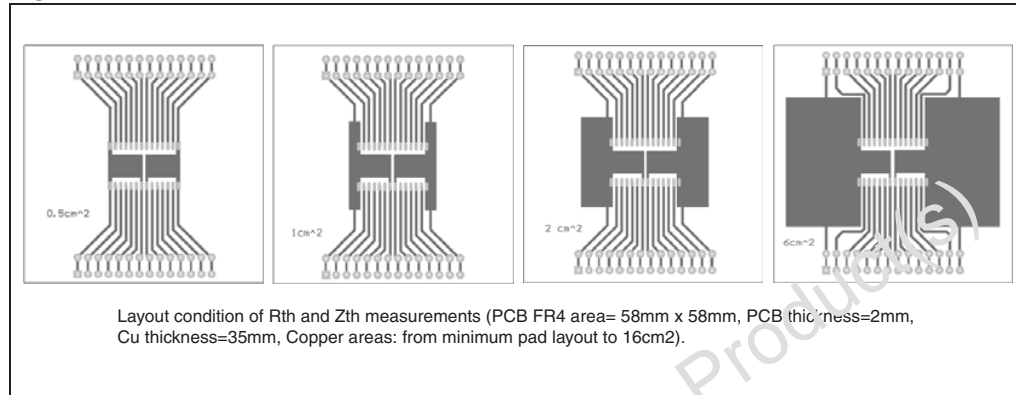

Figure 38. Chipset configuration

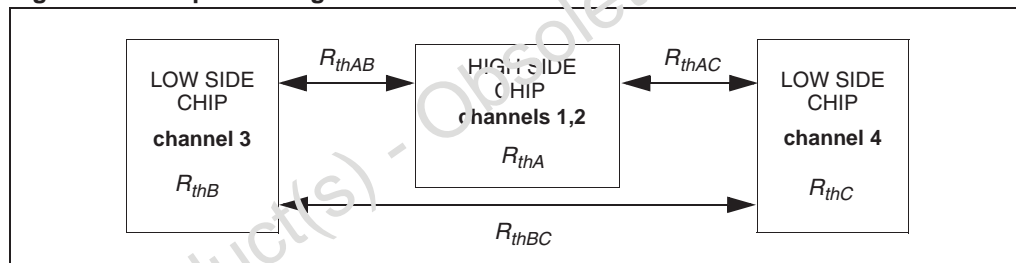

Figure 39. Auto and mutual $R_{thj-amb}$ vs PCB copper area in open box free air condition^(a)

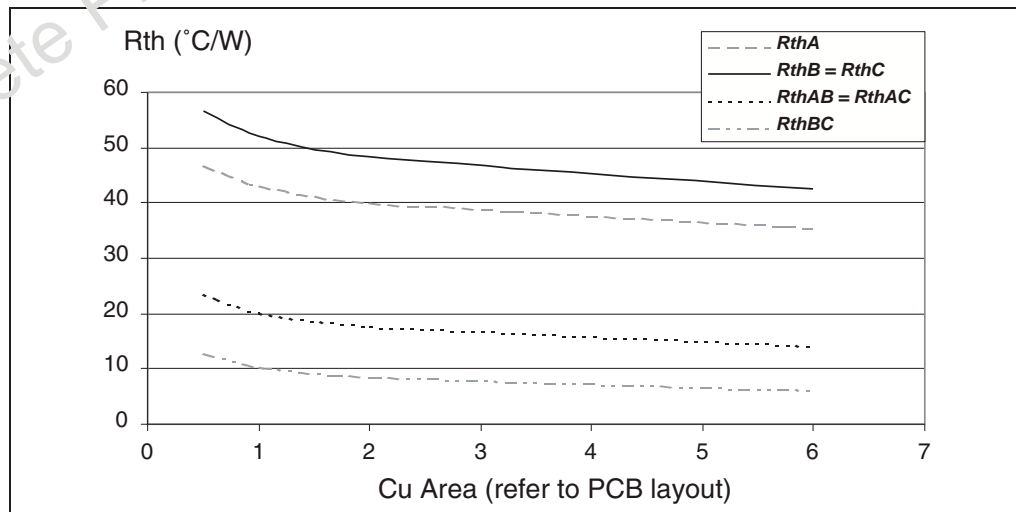

Table 17. Thermal calculations in clockwise and anti-clockwise operation in steady-state mode

HS ₁	HS ₂	LS ₃	LS ₄	T _{jHS12}	T _{jLS3}	T _{jLS4}
ON	OFF	OFF	ON	$P_{dHS1} \times R_{thHS} + P_{dLS4} \times R_{thHLSLS} + T_{amb}$	$P_{dHS1} \times R_{thHLSLS} + P_{dLS4} \times R_{thLSLS} + T_{amb}$	$P_{dHS1} \times R_{thHLSLS} + P_{dLS4} \times R_{thLS} + T_{amb}$
OFF	ON	ON	OFF	$P_{dHS2} \times R_{thHS} + P_{dLS3} \times R_{thHLSLS} + T_{amb}$	$P_{dHS2} \times R_{thHLSLS} + P_{dLS3} \times R_{thLS} + T_{amb}$	$P_{dHS2} \times R_{thHLSLS} + P_{dLS3} \times R_{thLSLS} + T_{amb}$

Table 18. Thermal resistances definitions⁽¹⁾

$R_{thHS} = R_{thHS1} = R_{thHS2}$	High-side chip thermal resistance junction to ambient (HS ₁ or HS ₂ in ON state)
$R_{thLS} = R_{thLS3} = R_{thLS4}$	Low-side chip thermal resistance junction to ambient
$R_{thHLSLS} = R_{thHS1LS4} = R_{thHS2LS3}$	Mutual thermal resistance junction to ambient between high-side and low-side chips
$R_{thLSLS} = R_{thLS3LS4}$	Mutual thermal resistance junction to ambient between low-side chips

1. values dependent on PCB heatsink area

Table 19. Single pulse thermal impedance definitions⁽¹⁾

Z _{thHS}	High-side chip thermal impedance junction to ambient
Z _{thLS} = Z_{thLS3} = Z_{thLS4}}	Low-side chip thermal impedance junction to ambient
Z _{thHLSLS} = Z_{thHS12LS3} = Z_{thHS12LS4}}	Mutual thermal impedance junction to ambient between high-side and low-side chips
Z _{thLSLS} = Z_{thLS3LS4}}	Mutual thermal impedance junction to ambient between low-side chips

1. values dependent on PCB heatsink area

Table 20. Thermal calculations in transient mode⁽¹⁾

T _{jHS12}	$Z_{thHS} \times P_{dHS12} + Z_{thHLSLS} \times (P_{dLS3} + P_{dLS4}) + T_{amb}$
T _{jLS3}	$Z_{thHLSLS} \times P_{dHS12} + Z_{thLS} \times P_{dLS3} + Z_{thLSLS} \times P_{dLS4} + T_{amb}$
T _{jLS4}	$Z_{thHLSLS} \times P_{dHS12} + Z_{thLSLS} \times P_{dLS3} + Z_{thLS} \times P_{dLS4} + T_{amb}$

1. Calculation is valid in any dynamic operating condition. Pd values set by user.

a. See [Figure 38](#). For more detailed information see [Table 17](#) and [Table 18](#).

Figure 40. SO-28 HSD thermal impedance junction ambient single pulse

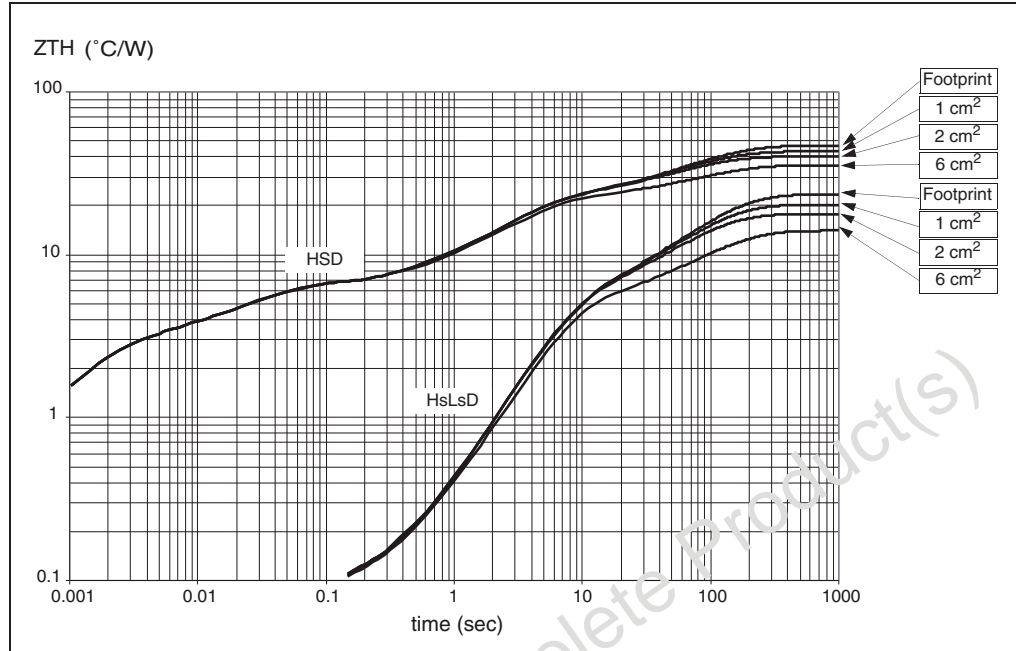

Figure 41. SO-28 LSD thermal impedance junction ambient single pulse

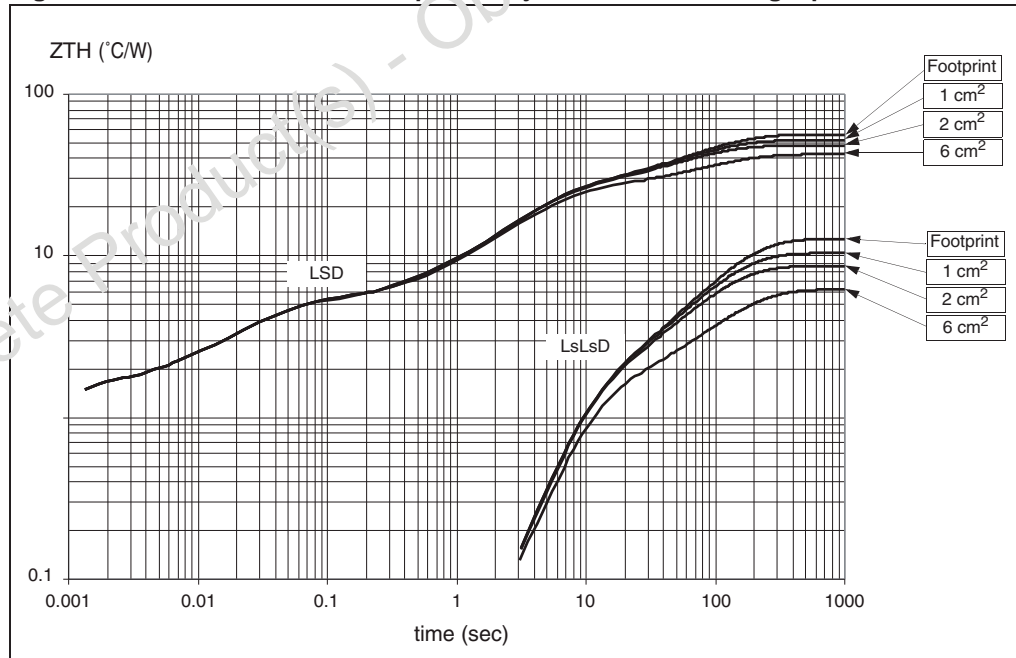

Table 21. Thermal parameters⁽¹⁾ (continued)

Area/island (cm ²)	Footprint	1	2	6
R15 (°C/W)	0.24			
R16 (°C/W)	1.2			
R17 (°C/W)	3.5			
R18 (°C/W)	15.5			
R19 (°C/W)	10.5			
R20 (°C/W)	62.28	52.28	44.28	32.28
R21 (°C/W)	150			
R22 (°C/W)	150			
R23 (°C/W)	150			
R24 (°C/W)	150	52.28	44.28	32.28
C1 (W·s/°C)	0.0008			
C2 (W·s/°C)	0.001			
C3 (W·s/°C)	0.008			
C5 (W·s/°C)	0.2			
C6 (W·s/°C)	1.6	1.61	1.7	3.25
C7 (W·s/°C)	0.0008			
C8 (W·s/°C)	0.001			
C9 (W·s/°C)	0.00015			
C10 (W·s/°C)	0.0005			
C11 (W·s/°C)	0.008			
C13 (W·s/°C)	0.2			
C14 (W·s/°C)	1.6	1.61	1.7	3.25
C15 (W·s/°C)	0.00015			
C16 (W·s/°C)	0.0005			
C17 (W·s/°C)	0.008			
C19 (W·s/°C)	0.2			
C20 (W·s/°C)	1.6	1.61	1.7	3.25

1. A blank space means that the value is the same as the previous one

6 Package and packing information

6.1 ECOPACK®

In order to meet environmental requirements, ST offers these devices in different grades of ECOPACK® packages, depending on their level of environmental compliance. ECOPACK® specifications, grade definitions and product status are available at: www.st.com. ECOPACK® is an ST trademark.

6.2 SO-28 package information

Table 22. SO-28 mechanical data

Symbol	millimeters		
	Min	Typ	Max
A			2.65
a1	0.10		0.30
b	0.35		0.49
b1	0.23		0.32
C		0.50	
c1	45° (typ.)		
D	17.7		18.1
E	10.00		10.65
e		1.27	
e3		16.51	
F	7.40		7.60
L	0.40		1.27
S	8° (max.)		

Figure 43. SO-28 package dimensions

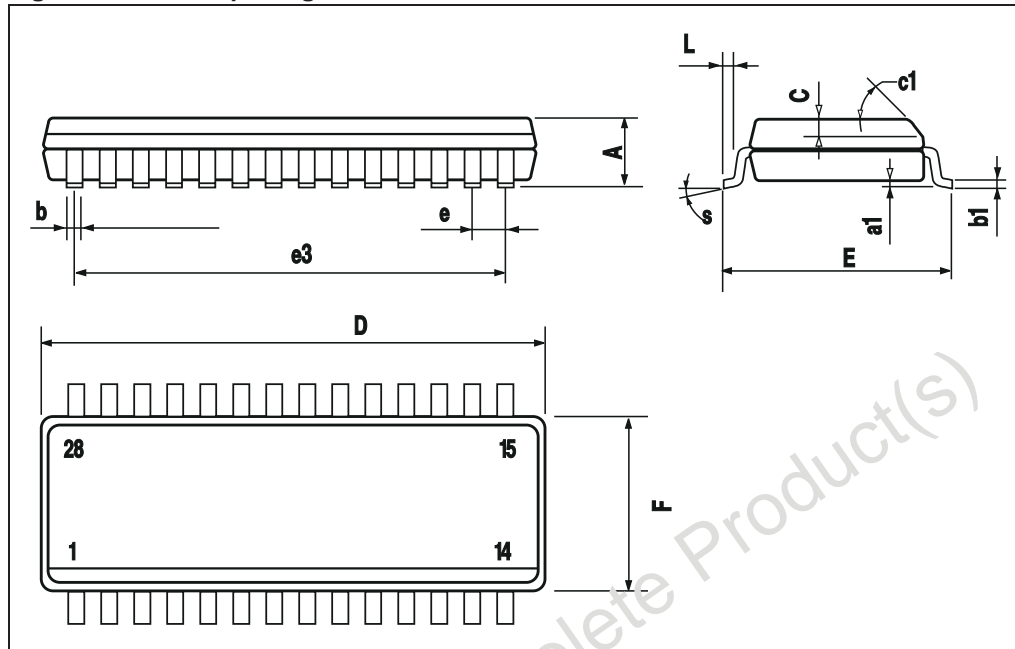

Obsolete Product(s) - Obsolete Product(s)

6.3 SO-28 packing information

Figure 44. SO-28 tube shipment (no suffix)

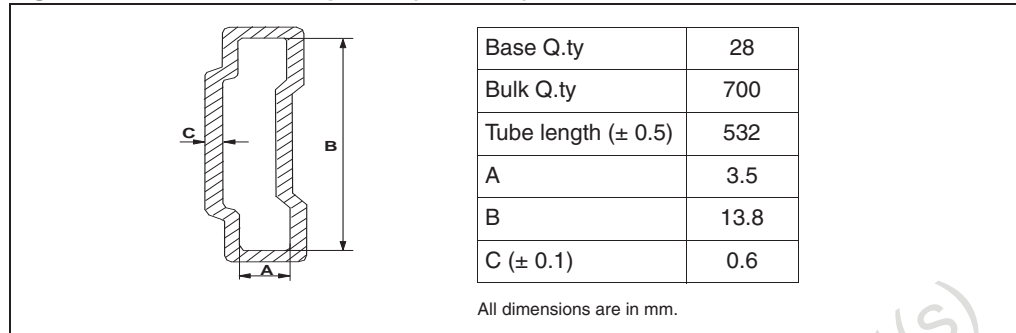
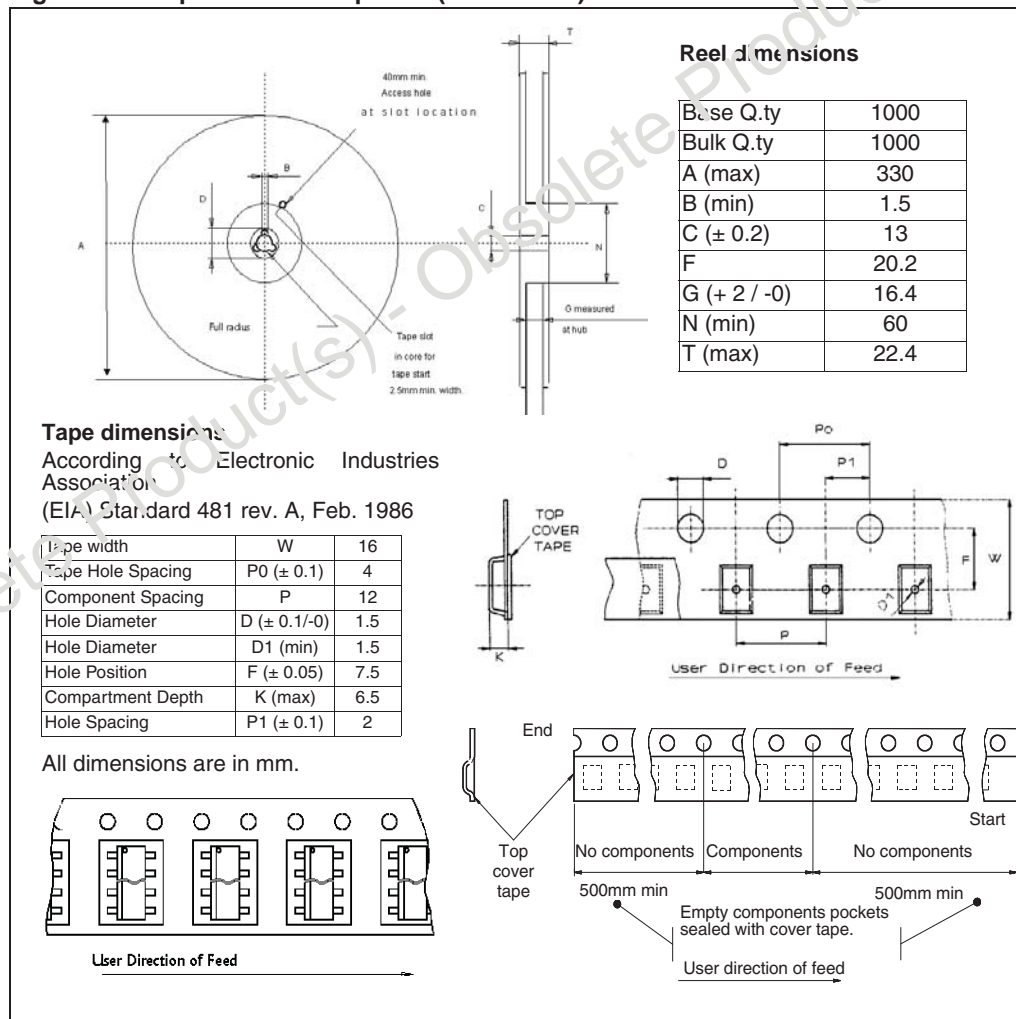

Figure 45. Tape and reel shipment (suffix "TR")



7 Order codes

Table 23. Device summary

Package	Order codes	
	Tube	Tape and reel
SO-28	VN5770AK-E	VN5770AKTR-E

Obsolete Product(s) - Obsolete Product(s)

8 Revision history

Table 24. Document revision history

Date	Revision	Changes
June-2006	1	Initial release.
15-Feb-2007	2	<p>Reformatted.</p> <p><i>Table 5: Power section</i> updated.</p> <p><i>Table 6: Switching (VCC = 13V)</i> updated.</p> <p><i>Table 9: Current sense (8V<VCC<16V)</i> updated.</p> <p><i>Table 12: On</i> updated.</p> <p><i>Table 14: Switching (T_j = 25°C, unless otherwise specified)</i> updated.</p> <p>Characteristic curves for high-side and low-side switches added.</p> <p><i>Figure 38: Chipset configuration</i> updated.</p> <p><i>Figure 39: Auto and mutual R_{thj-amb} vs PCB copper area in open box free air condition</i> added.</p> <p><i>Figure 40: SO-28 HSD thermal impedance junction ambient single pulse, Figure 41: SO-28 LSD thermal impedance junction ambient single pulse and Figure 42: Thermal fitting model of an H-Bridge in SO-28</i> added.</p> <p><i>Figure 21: Thermal parameters</i> added.</p> <p>High-side and low-side characteristic curves added.</p> <p><i>Figure 35: Waveforms</i> added.</p> <p><i>Section 4.1: Maximum demagnetization energy (V_{CC} = 13.5V)</i> added.</p> <p><i>Figure 33: Typical application schematic</i> added.</p>
02-Jul-2007	3	<i>Table 9: Current sense (8V<VCC<16V)</i> updated
24-Jul-2007	4	<i>Table 9: Current sense (8V<VCC<16V)</i> - K ₀ , K ₁ and K ₃ values modified
04-Jan-2012	5	<i>Table 9: Current sense (8V<VCC<16V)</i> - K ₀ values modified
12-Feb-2012	6	Update <i>Figure 2: Configuration diagram (top view)</i> and <i>Figure 33: Typical application schematic</i>

Please Read Carefully:

Information in this document is provided solely in connection with ST products. STMicroelectronics NV and its subsidiaries ("ST") reserve the right to make changes, corrections, modifications or improvements, to this document, and the products and services described herein at any time, without notice.

All ST products are sold pursuant to ST's terms and conditions of sale.

Purchasers are solely responsible for the choice, selection and use of the ST products and services described herein, and ST assumes no liability whatsoever relating to the choice, selection or use of the ST products and services described herein.

No license, express or implied, by estoppel or otherwise, to any intellectual property rights is granted under this document. If any part of this document refers to any third party products or services it shall not be deemed a license grant by ST for the use of such third party products or services, or any intellectual property contained therein or considered as a warranty covering the use in any manner whatsoever of such third party products or services or any intellectual property contained therein.

UNLESS OTHERWISE SET FORTH IN ST'S TERMS AND CONDITIONS OF SALE ST DISCLAIMS ANY EXPRESS OR IMPLIED WARRANTY WITH RESPECT TO THE USE AND/OR SALE OF ST PRODUCTS INCLUDING WITHOUT LIMITATION IMPLIED WARRANTIES OF MERCHANTABILITY, FITNESS FOR A PARTICULAR PURPOSE (AND THEIR EQUIVALENTS UNDER THE LAWS OF ANY JURISDICTION), OR INFRINGEMENT OF ANY PATENT, COPYRIGHT OR OTHER INTELLECTUAL PROPERTY RIGHT.

UNLESS EXPRESSLY APPROVED IN WRITING BY TWO AUTHORIZED ST REPRESENTATIVES, ST PRODUCTS ARE NOT RECOMMENDED, AUTHORIZED OR WARRANTED FOR USE IN MILITARY, AIR CRAFT, SPACE, LIFE SAVING, OR LIFE SUSTAINING APPLICATIONS, NOR IN PRODUCTS OR SYSTEMS WHERE FAILURE OR MALFUNCTION MAY RESULT IN PERSONAL INJURY, DEATH, OR SEVERE PROPERTY OR ENVIRONMENTAL DAMAGE. ST PRODUCTS WHICH ARE NOT SPECIFIED AS "AUTOMOTIVE GRADE" MAY ONLY BE USED IN AUTOMOTIVE APPLICATIONS AT USER'S OWN RISK.

Resale of ST products with provisions different from the statements and/or technical features set forth in this document shall immediately void any warranty granted by ST for the ST product or service described herein and shall not create or extend in any manner whatsoever, any liability of ST.

ST and the ST logo are trademarks or registered trademarks of ST in various countries.

Information in this document supersedes and replaces all information previously supplied.

The ST logo is a registered trademark of STMicroelectronics. All other names are the property of their respective owners.

© 2012 STMicroelectronics - All rights reserved

STMicroelectronics group of companies

Australia - Belgium - Brazil - Canada - China - Czech Republic - Finland - France - Germany - Hong Kong - India - Israel - Italy - Japan - Malaysia - Malta - Morocco - Philippines - Singapore - Spain - Sweden - Switzerland - United Kingdom - United States of America

www.st.com