

阅读申明

- 1.本站收集的数据手册和产品资料都来自互联网，版权归原作者所有。如读者和版权方有任何异议请及时告之，我们将妥善解决。
- 2.本站提供的中文数据手册是英文数据手册的中文翻译，其目的是协助用户阅读，该译文无法自动跟随原稿更新，同时也可能存在翻译上的不当。建议读者以英文原稿为参考以便获得更精准的信息。
- 3.本站提供的产品资料，来自厂商的技术支持或者使用者的心得体会等，其内容可能存在描述上的差异，建议读者做出适当判断。
- 4.如需与我们联系，请发邮件到marketing@iczoom.com，主题请标有“数据手册”字样。

Read Statement

1. The datasheets and other product information on the site are all from network reference or other public materials, and the copyright belongs to the original author and original published source. If readers and copyright owners have any objections, please contact us and we will deal with it in a timely manner.
2. The Chinese datasheets provided on the website is a Chinese translation of the English datasheets. Its purpose is for reader's learning exchange only and do not involve commercial purposes. The translation cannot be automatically updated with the original manuscript, and there may also be improper translations. Readers are advised to use the English manuscript as a reference for more accurate information.
3. All product information provided on the website refer to solutions from manufacturers' technical support or users the contents may have differences in description, and readers are advised to take the original article as the standard.
4. If you have any questions, please contact us at marketing@iczoom.com and mark the subject with "Datasheets" .



TND506MD

General Purpose Driver for Applications Including PDP Sustain Pulse Drive, DC / AC Motor Drive, Ballast, Battery Charger, High Frequency Switching Power Supply, Induction Heating, and Switching Amplifiers

Features

- Monolithic structure.
- Allows simplified configuration of driver circuit.
- Withstand voltage of 600V is assured.
- Shutdown protection function.
- Low-side output-watching circuit.
- Fully compatible input to LSTTL/CMOS.
- Fast switching time(120ns at 1000pF load).
- Propagation delay is about 150ns.
- Output current : 220mA Source, 450mA Sink.

Package Dimensions

unit : mm
2198

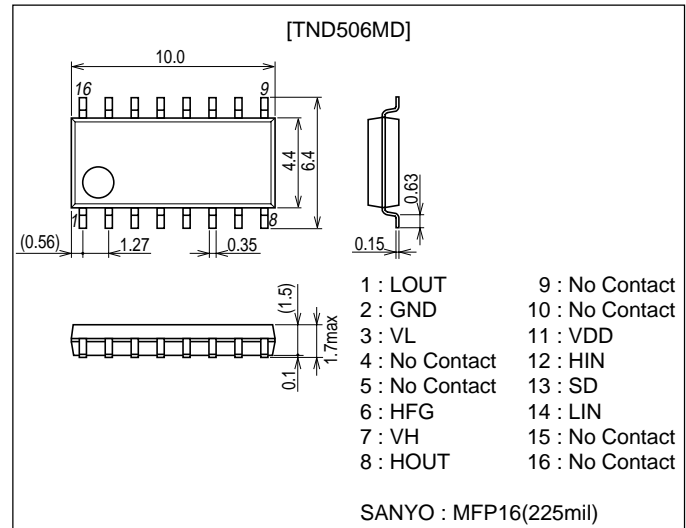

Specifications

Absolute Maximum Ratings at Ta=25°C (All voltage parameters are absolute voltage referenced to GND)

Parameter	Symbol	Conditions	Ratings	Unit
High Side Floating Supply Voltage	V _H		-0.3 to 625	V
High Side Floating Supply Offset Voltage	V _{HFG}		V _H -25 to V _H +0.3	V
High Side Output Voltage	V _{HOUT}		V _{HFG} -0.3 to V _H +0.3	V
Low Side Supply Voltage	V _L		-0.3 to 25	V
Low Side Output Voltage	V _{LOUT}		-0.3 to V _L +0.3	V
Logic Supply Voltage V _{DD}			-0.3 to 25	V
Logic Input Voltage(HIN, LIN, SD)	V _{IN}		-0.3 to V _{DD} +0.3	V
Allowable Power Dissipation	P _D	Mounted on a ceramic board	0.9	W
Junction Temperature	T _J		-55 to +150	°C
Storage Temperature	T _{stg}		-55 to +150	°C

- Any and all SANYO products described or contained herein do not have specifications that can handle applications that require extremely high levels of reliability, such as life-support systems, aircraft's control systems, or other applications whose failure can be reasonably expected to result in serious physical and/or material damage. Consult with your SANYO representative nearest you before using any SANYO products described or contained herein in such applications.
- SANYO assumes no responsibility for equipment failures that result from using products at values that exceed, even momentarily, rated values (such as maximum ratings, operating condition ranges, or other parameters) listed in products specifications of any and all SANYO products described or contained herein.

TND506MD

Recommended Operating Conditions at Ta=25°C

Parameter	Symbol	Conditions	Ratings	Unit
High Side Floating Supply Voltage	V _H		V _{HFG} +10 to V _{HFG} +20	V
High Side Floating Supply Offset Voltage	V _{HFG}		0 to 600	V
High Side Output Voltage	V _{HOUT}		V _{HFG} to V _H	V
Low Side Supply Voltage	V _L		10 to +20	V
Low Side Output Voltage	V _{LOUT}		0 to V _L	V
Logic Supply Voltage	V _{DD}		+5 to +20	V
Logic Input Voltage(HIN, LIN, SD)	V _{IN}		0 to V _{DD}	V
Ambient Temperature	Topr		-40 to +125	°C

AC Characteristics at Ta=25°C (V_{DD}=V_L=V_{HFG}=15V, C_L=1000pF)

Parameter	Symbol	Conditions	Ratings			Unit
			min	typ	max	
Turn-ON Delay Time	t _{on}	V _{HFG} =0V	105	150	195	ns
Turn-OFF Delay Time	t _{off}	V _{HFG} =600V	84	120	156	ns
Shutdown Delay Time	t _{sd}	V _{HFG} =600V		120		ns
Turn-ON Rise Time	t _r			120		ns
Turn-OFF Fall Time	t _f			60		ns
Delay Matching, HS and LS Turn-ON	M _{t_{on}}	Ht _{on} -Lt _{on}		15		ns
Delay Matching, HS and LS Turn-OFF	M _{t_{off}}	Ht _{off} -Lt _{off}		15		ns

DC Characteristics at Ta=25°C, (V_{DD}=V_L=V_{HFG}=15V)

Parameter	Symbol	Conditions	Ratings			Unit
			min	typ	max	
Logic "1" Input Voltage	V _{IH}	V _{DD} =5V	3.2			V
		V _{DD} =10V	6.4			V
		V _{DD} =15V	9.5			V
		V _{DD} =20V	12.8			V
Logic "0" Input Voltage	V _{IL}	V _{DD} =5V			1.5	V
		V _{DD} =10V			3.7	V
		V _{DD} =15V			5.8	V
		V _{DD} =20V			7.7	V
High-level Output Voltage, V _{BIAS-VO}	V _{OH}	V _{IN} =V _{IH} , I _O =0A			0.1	V
Low-level Output Voltage, V _O	V _{OL}	V _{IN} =V _{IL} , I _O =0A			0.1	V
Offset Supply Leakage Current	I _{LK}	V _H =V _{HFG} =600V			10	μA
Quiescent V _H Supply Current	I _{QH}	V _{IN} =0V or V _{DD}		35	60	μA
Quiescent V _L Supply Current	I _{QL}	V _{IN} =0V or V _{DD}		120	200	μA
Quiescent V _{DD} Supply Current	I _{QDD}	V _{IN} =0V or V _{DD}		5	20	μA
Logic "1" Input Bias Current	I _{IN+}	V _{IN} =V _{DD}		20	55	μA
Logic "0" Input Bias Current	I _{IN-}	V _{IN} =0V			1	μA
V _H Supply Undervoltage Positive Going Threshold	V _{HUV+}		7.6	8.9	9.9	V
V _H Supply Undervoltage Negative Going Threshold	V _{HUV-}		6.7	8.1	9.5	V
V _L Supply Undervoltage Positive Going Threshold	V _{LUV+}		7.6	8.9	9.9	V
V _L Supply Undervoltage Negative Going Threshold	V _{LUV-}		6.7	8.1	9.5	V
Output High Short Circuit Pulsed Current	I _{O+}	V _{OUT} =0V, V _{IN} =15V, PW≤10μs	220	250		mA
Output Low Short Circuit Pulsed Current	I _{O-}	V _{OUT} =15V, V _{IN} =0V, PW≤10μs	450	500		mA

Sequence of supply voltage

High Side Floating Supply Voltage V_H should be inputted after Low Side Supply Voltage V_L is inputted.

TND506MD

Functional Block Diagram

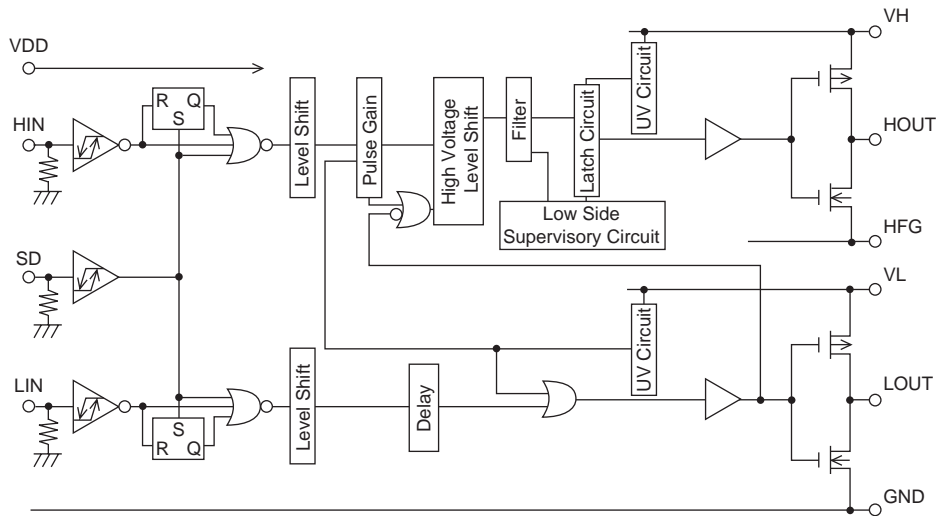

Switching Time Waveform Definition

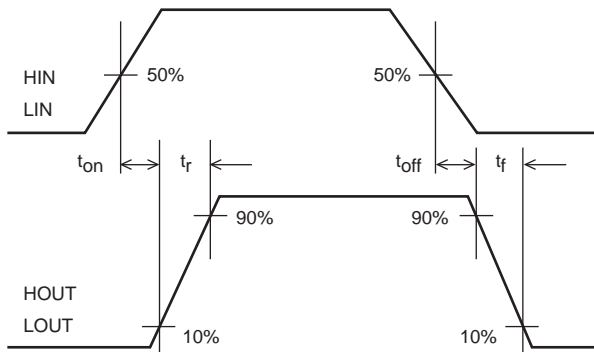

Shutdown Waveform Definition

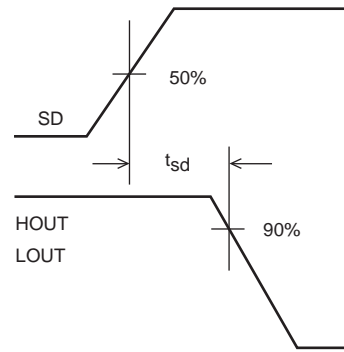

Delay Matching Waveform Definition

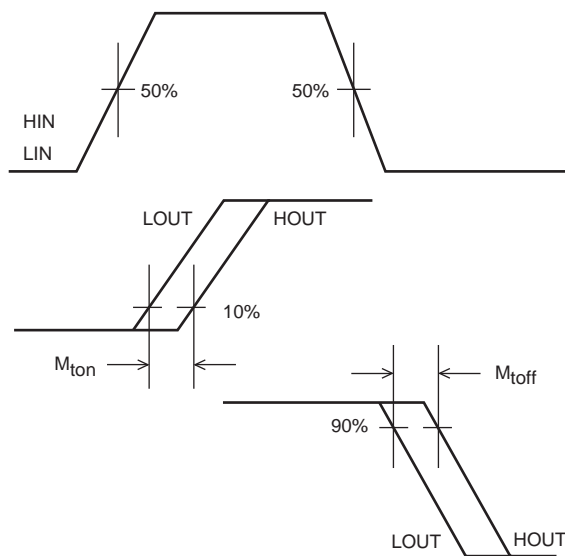

Switching Time Test Circuit

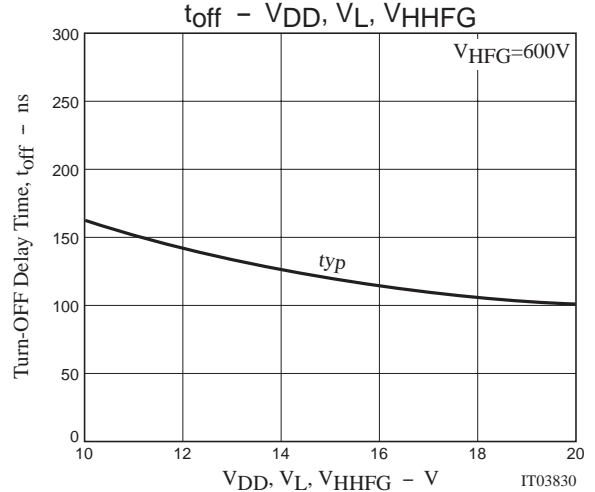
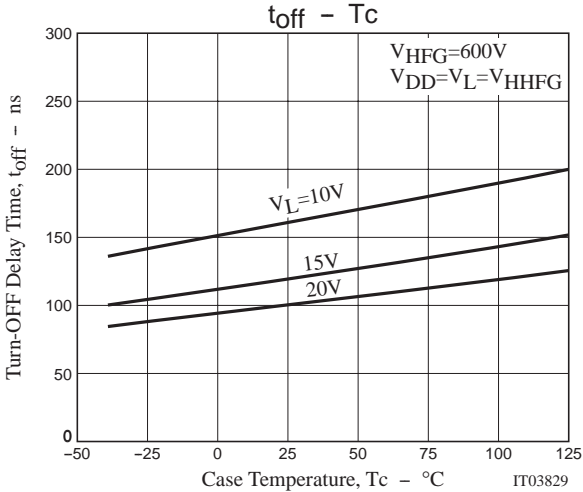
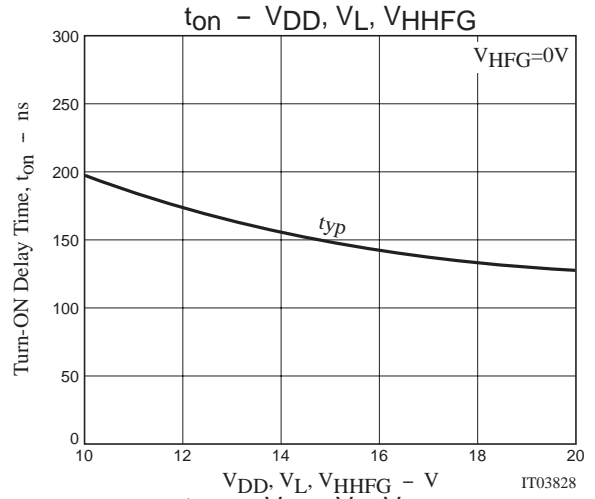
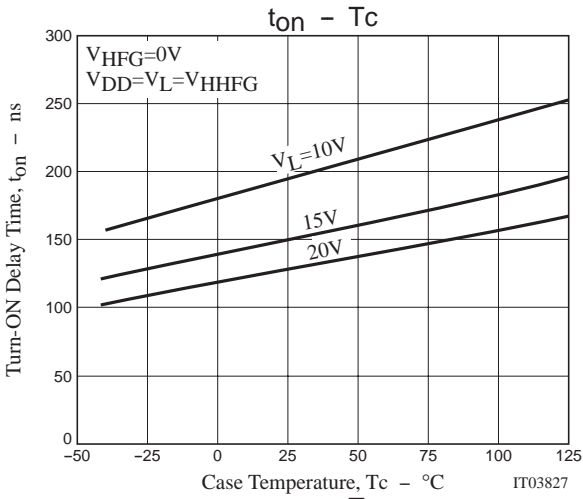
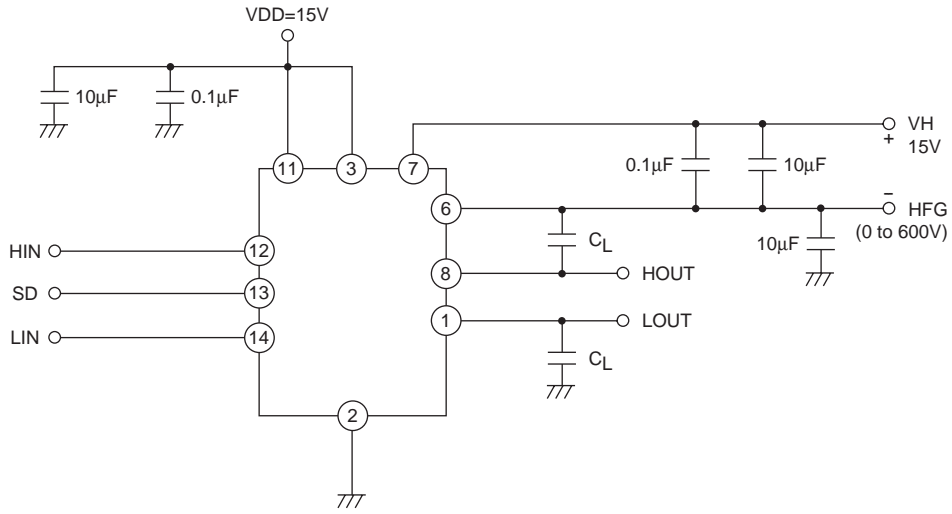

TND506MD

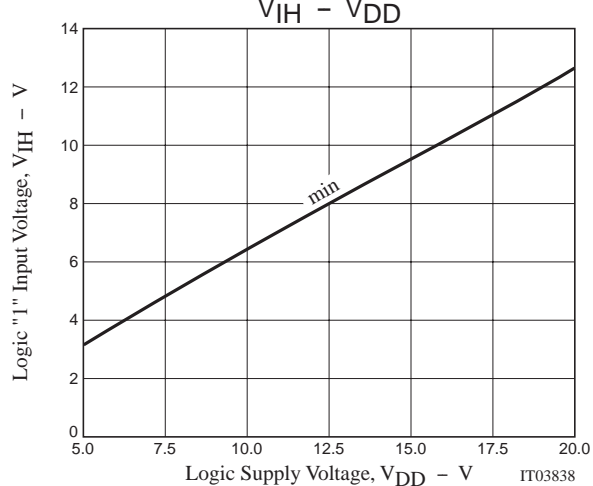
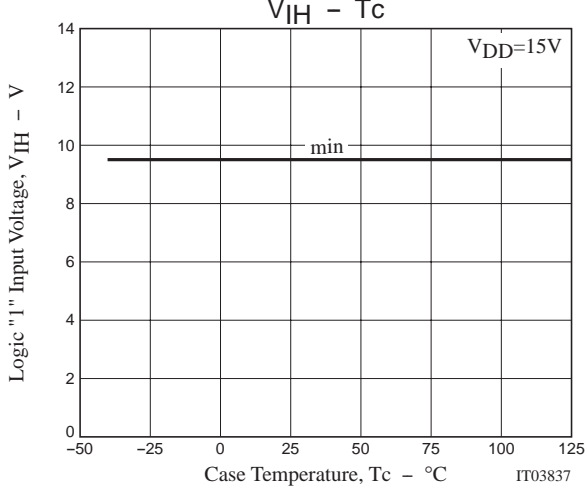
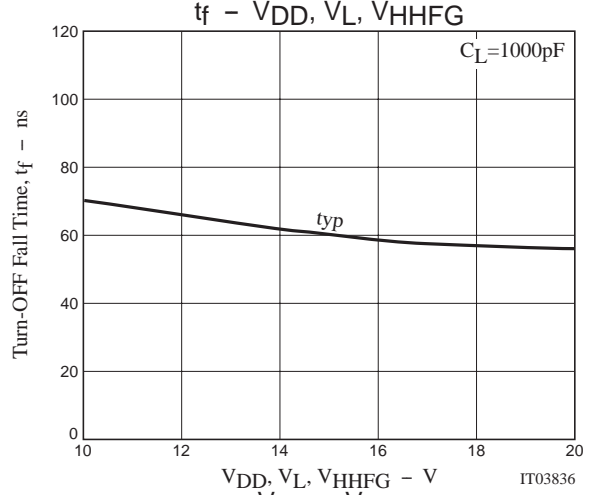
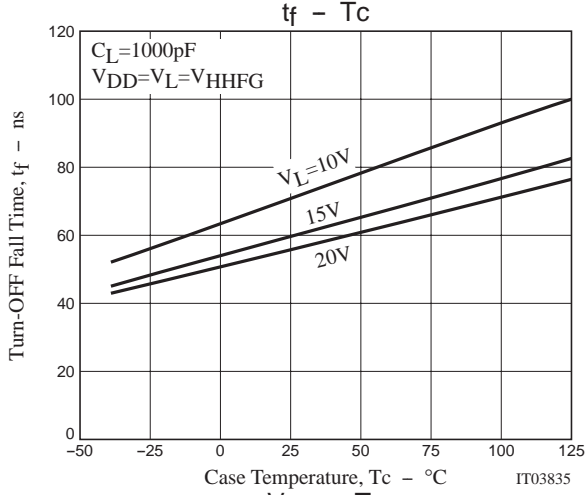
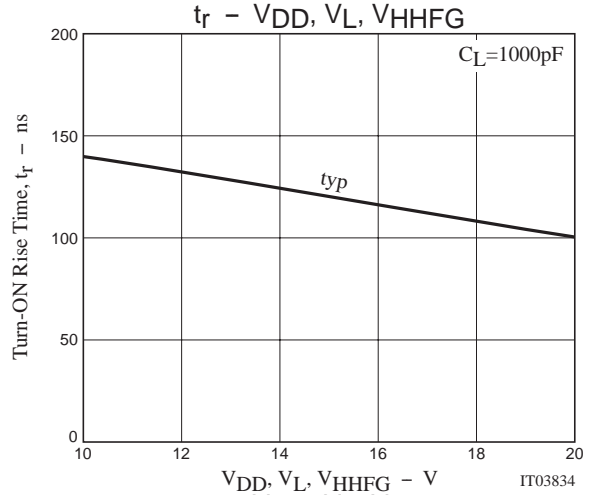
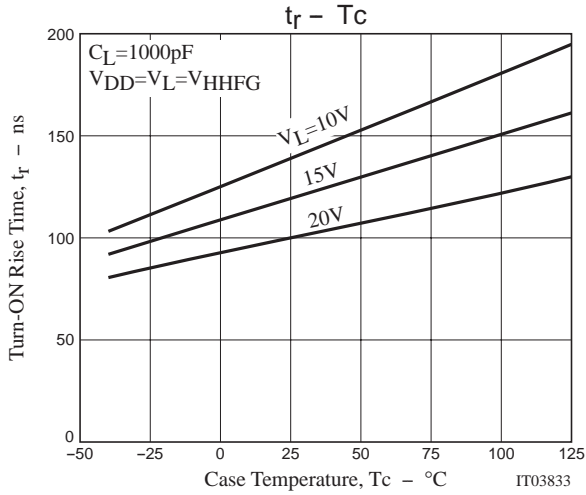
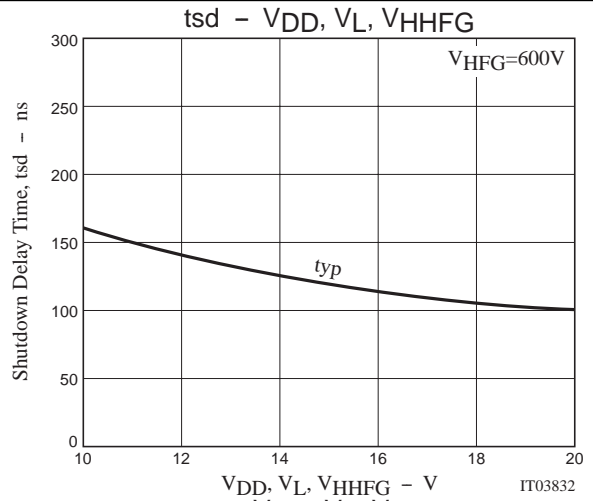
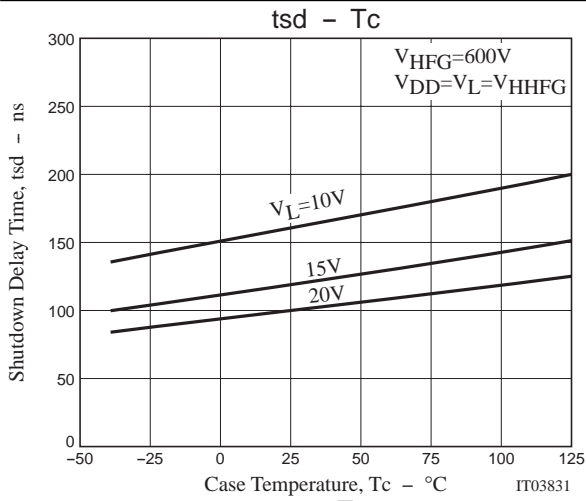

TND506MD

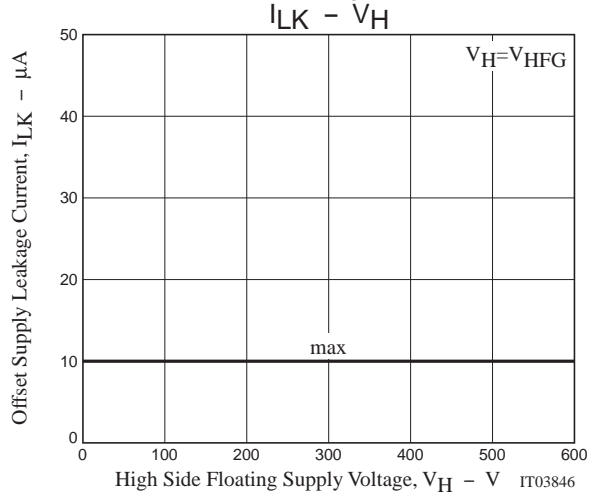
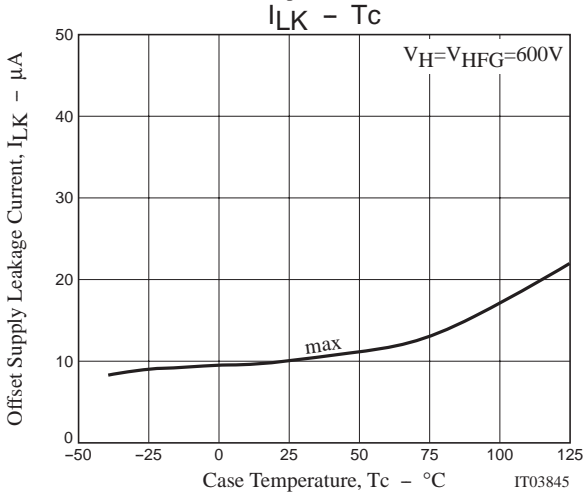
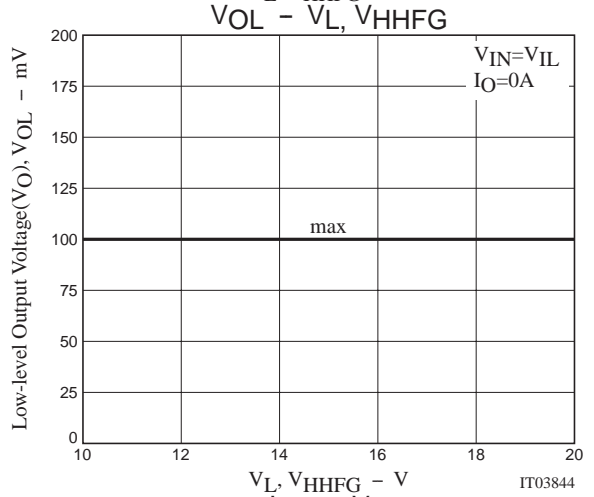
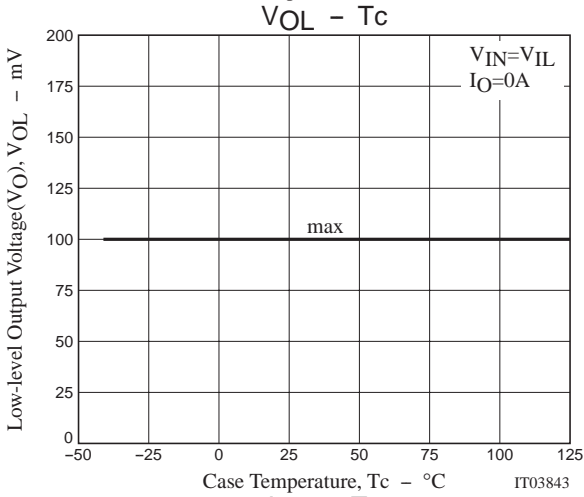
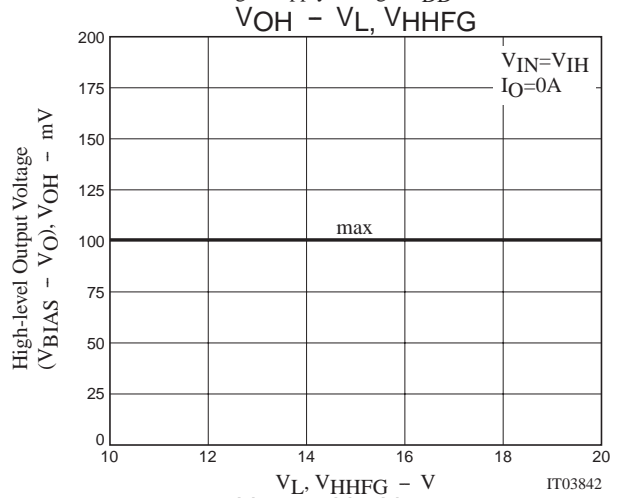
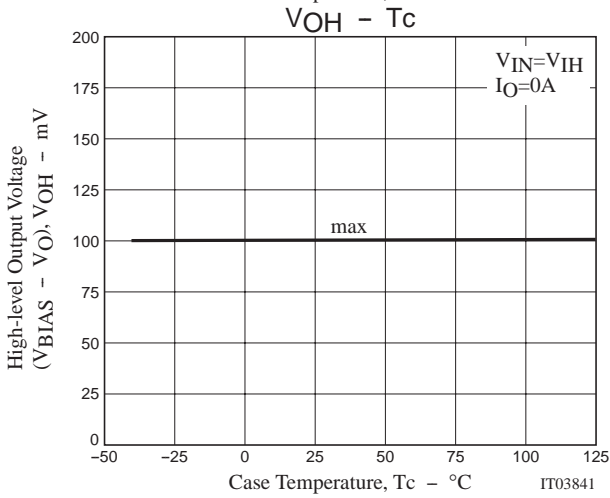
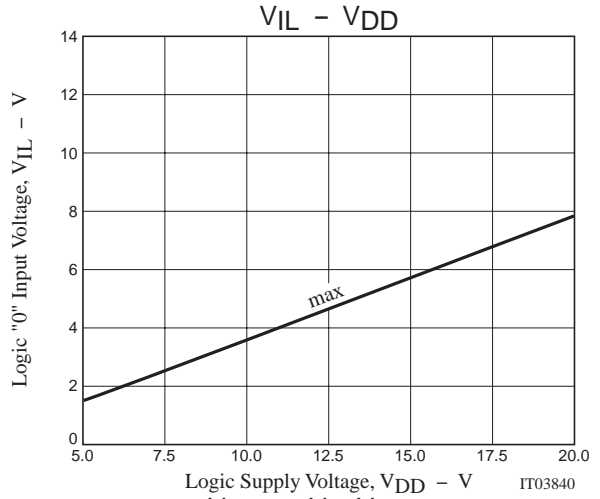
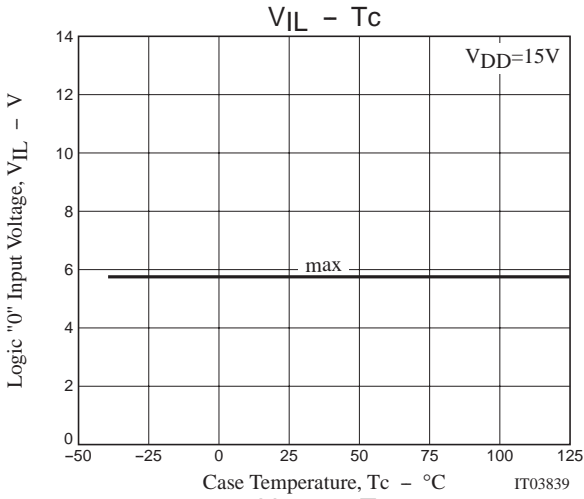

TND506MD

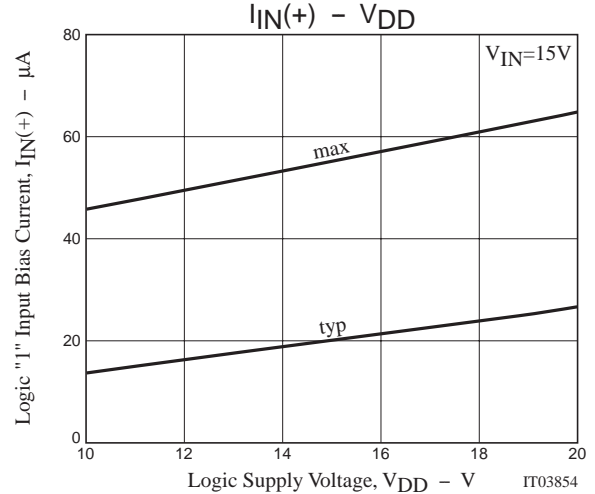
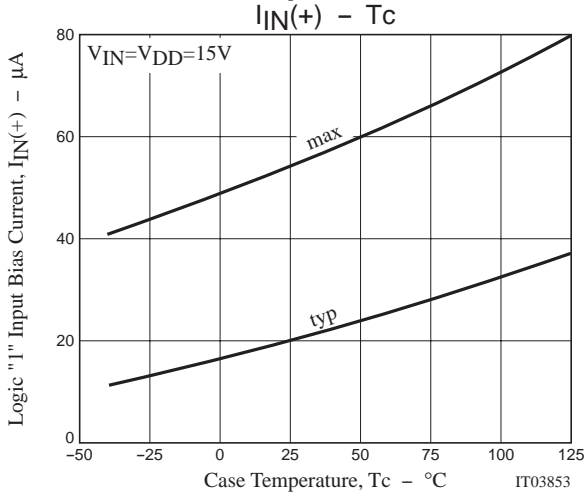
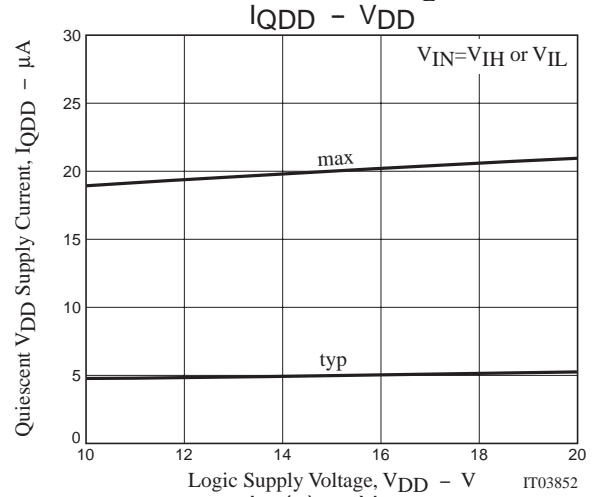
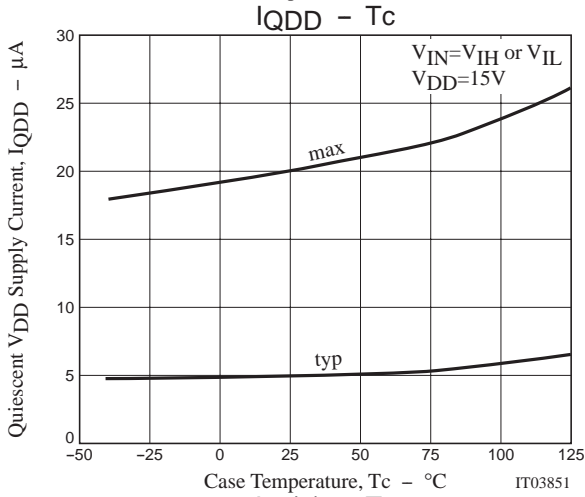
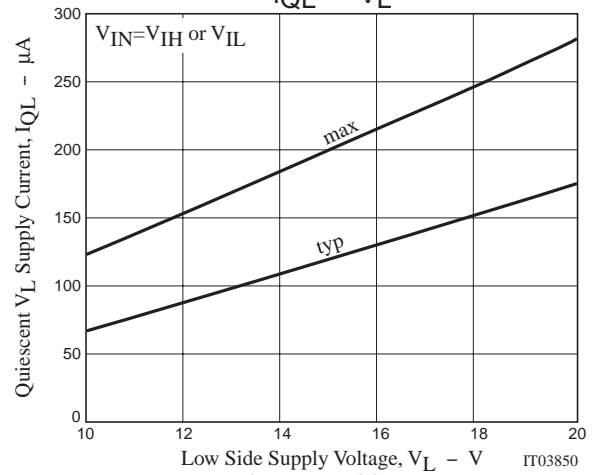
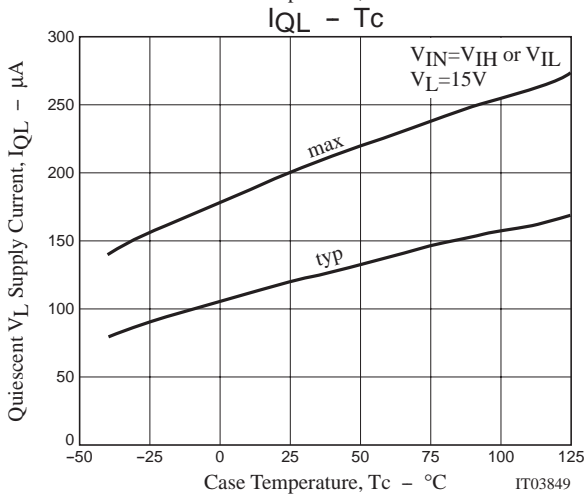
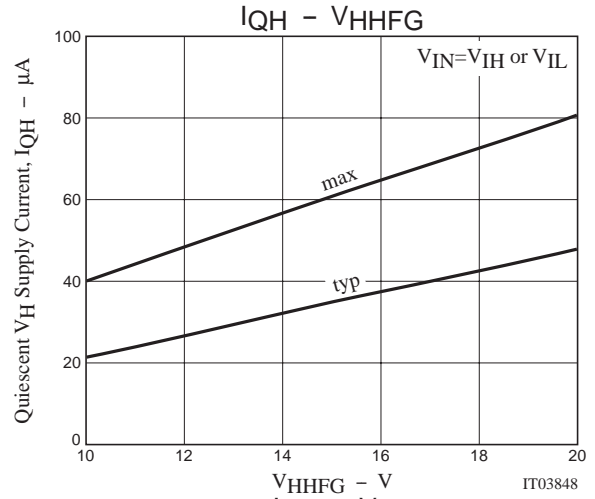
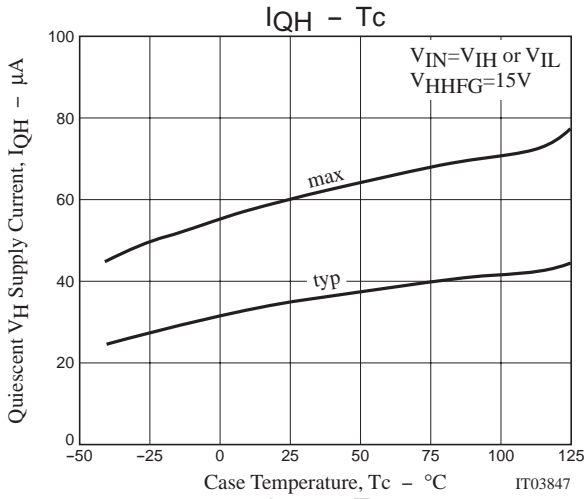

TND506MD

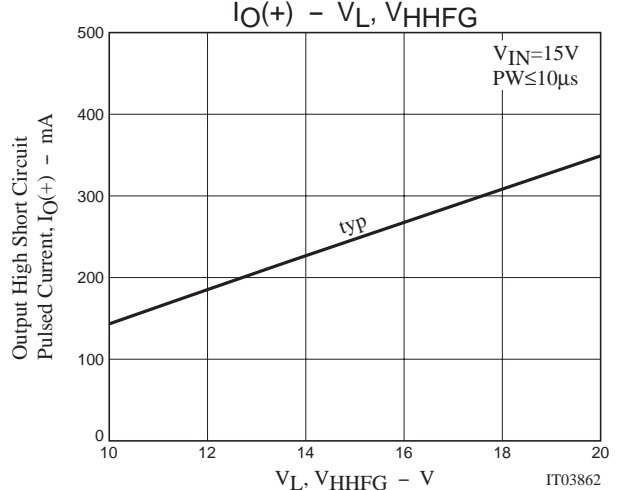
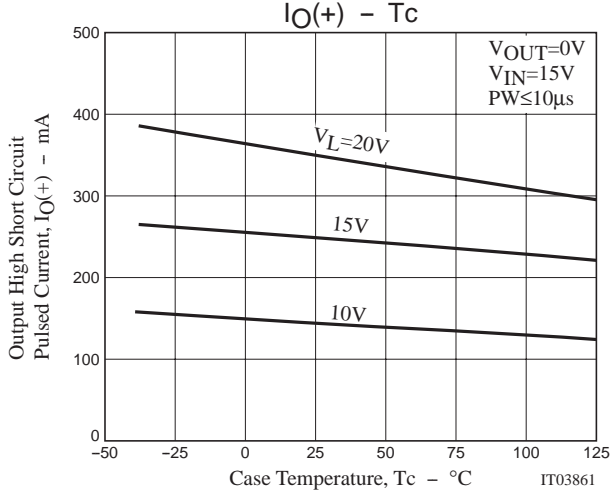
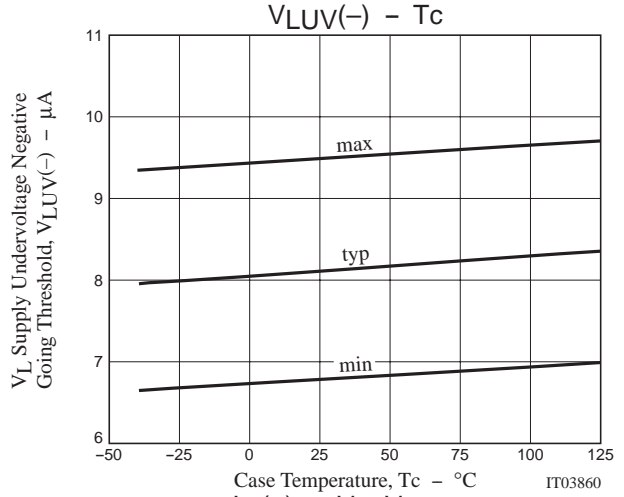
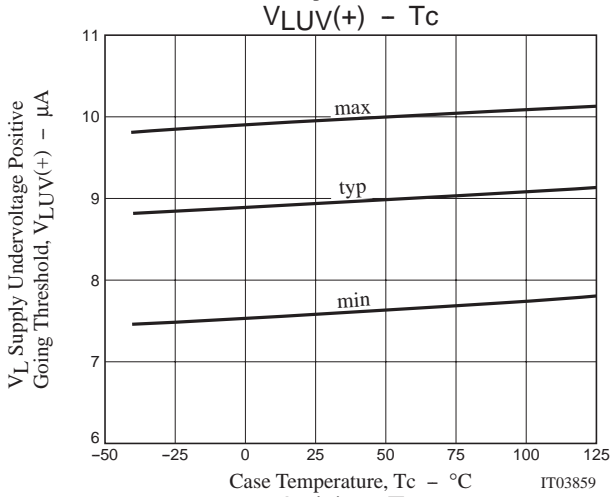
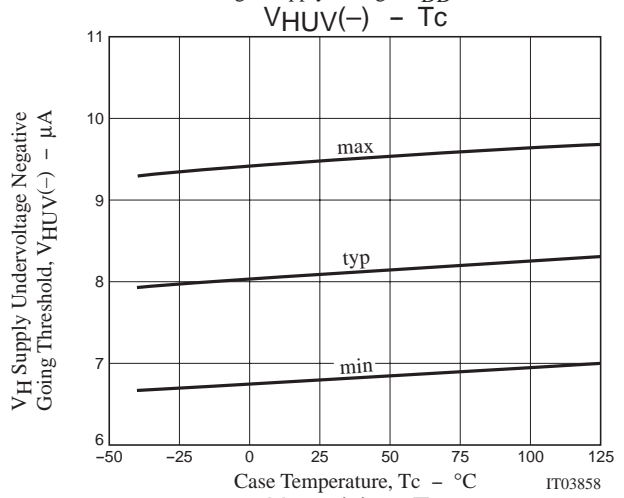
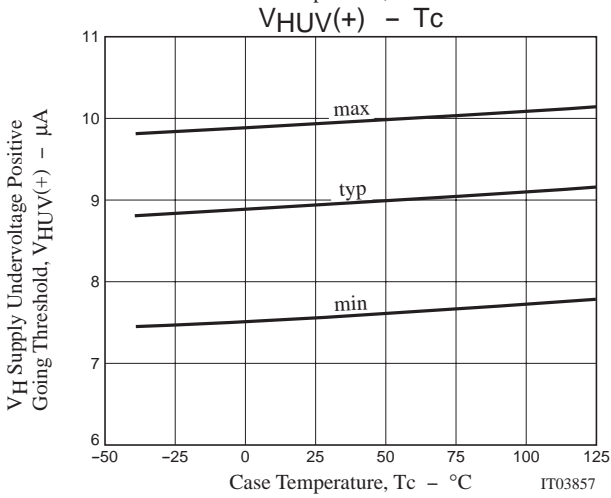
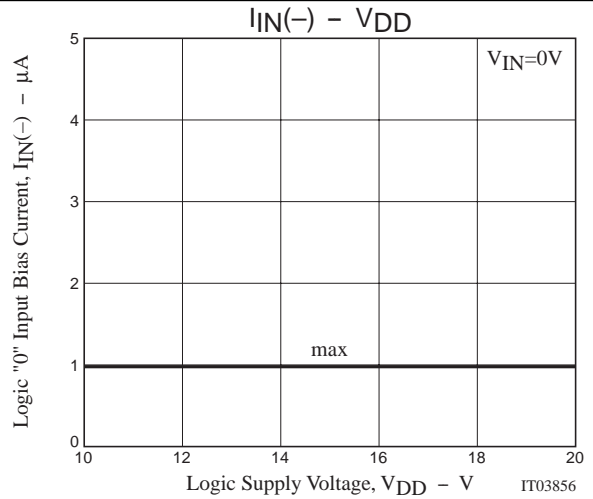
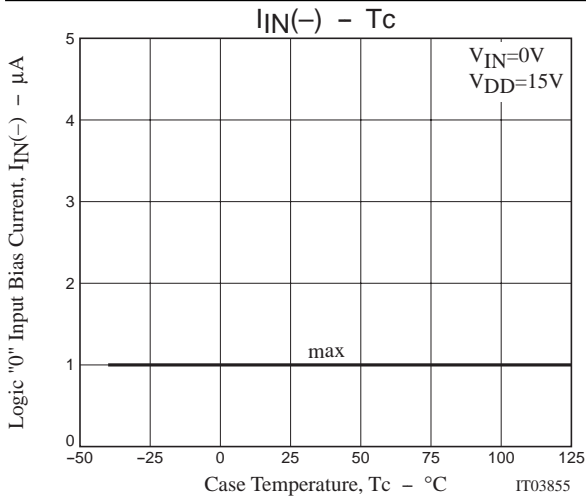

TND506MD

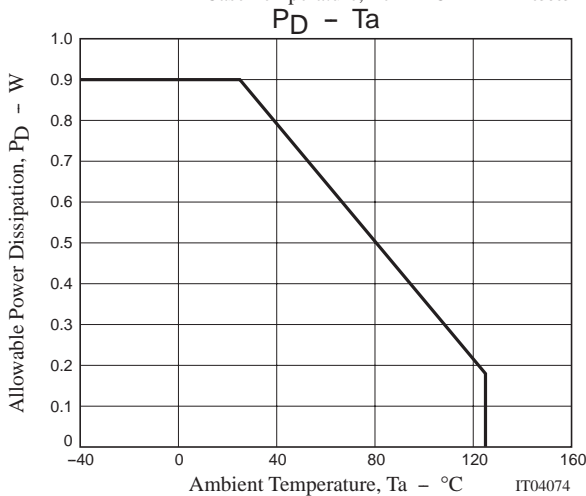
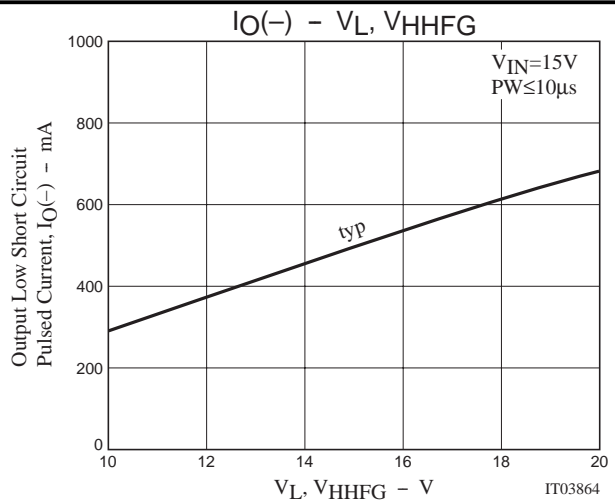
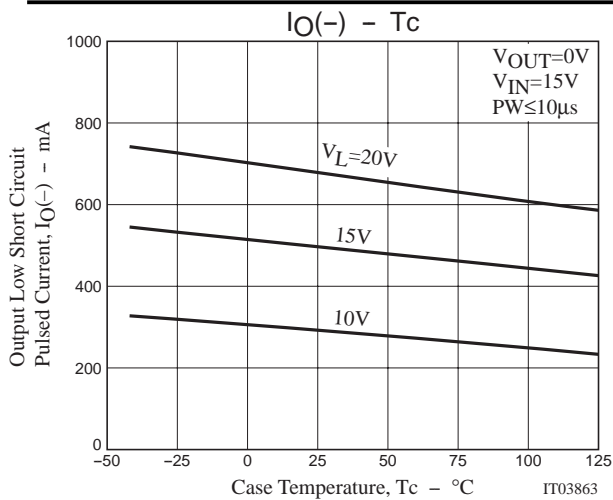

- Specifications of any and all SANYO products described or contained herein stipulate the performance, characteristics, and functions of the described products in the independent state, and are not guarantees of the performance, characteristics, and functions of the described products as mounted in the customer's products or equipment. To verify symptoms and states that cannot be evaluated in an independent device, the customer should always evaluate and test devices mounted in the customer's products or equipment.
- SANYO Electric Co., Ltd. strives to supply high-quality high-reliability products. However, any and all semiconductor products fail with some probability. It is possible that these probabilistic failures could give rise to accidents or events that could endanger human lives, that could give rise to smoke or fire, or that could cause damage to other property. When designing equipment, adopt safety measures so that these kinds of accidents or events cannot occur. Such measures include but are not limited to protective circuits and error prevention circuits for safe design, redundant design, and structural design.
- In the event that any or all SANYO products(including technical data, services) described or contained herein are controlled under any of applicable local export control laws and regulations, such products must not be exported without obtaining the export license from the authorities concerned in accordance with the above law.
- No part of this publication may be reproduced or transmitted in any form or by any means, electronic or mechanical, including photocopying and recording, or any information storage or retrieval system, or otherwise, without the prior written permission of SANYO Electric Co., Ltd.
- Any and all information described or contained herein are subject to change without notice due to product/technology improvement, etc. When designing equipment, refer to the "Delivery Specification" for the SANYO product that you intend to use.
- Information (including circuit diagrams and circuit parameters) herein is for example only ; it is not guaranteed for volume production. SANYO believes information herein is accurate and reliable, but no guarantees are made or implied regarding its use or any infringements of intellectual property rights or other rights of third parties.

This catalog provides information as of July, 2003. Specifications and information herein are subject to change without notice.