

阅读申明

- 1.本站收集的数据手册和产品资料都来自互联网，版权归原作者所有。如读者和版权方有任何异议请及时告之，我们将妥善解决。
- 2.本站提供的中文数据手册是英文数据手册的中文翻译，其目的是协助用户阅读，该译文无法自动跟随原稿更新，同时也可能存在翻译上的不当。建议读者以英文原稿为参考以便获得更精准的信息。
- 3.本站提供的产品资料，来自厂商的技术支持或者使用者的心得体会等，其内容可能存在描述上的差异，建议读者做出适当判断。
- 4.如需与我们联系，请发邮件到marketing@iczoom.com，主题请标有“数据手册”字样。

Read Statement

1. The datasheets and other product information on the site are all from network reference or other public materials, and the copyright belongs to the original author and original published source. If readers and copyright owners have any objections, please contact us and we will deal with it in a timely manner.
2. The Chinese datasheets provided on the website is a Chinese translation of the English datasheets. Its purpose is for reader's learning exchange only and do not involve commercial purposes. The translation cannot be automatically updated with the original manuscript, and there may also be improper translations. Readers are advised to use the English manuscript as a reference for more accurate information.
3. All product information provided on the website refer to solutions from manufacturers' technical support or users the contents may have differences in description, and readers are advised to take the original article as the standard.
4. If you have any questions, please contact us at marketing@iczoom.com and mark the subject with "Datasheets" .



Features

- Logic Level Input
- Input Protection (ESD)
- Thermal shutdown with latch
- Overload protection
- Short circuit protection
- Overvoltage protection
- Current limitation
- Status feedback with external input resistor
- Analog driving possible
- AEC qualified
- Green product (RoHS compliant)

Product Summary

| | | | |
|----------------------|--------------|------|------------|
| Drain source voltage | V_{DS} | 60 | V |
| On-state resistance | $R_{DS(on)}$ | 28 | m Ω |
| Current limit | $I_{D(lim)}$ | 25 | A |
| Nominal load current | $I_{D(ISO)}$ | 12 | A |
| Clamping energy | E_{AS} | 4000 | mJ |

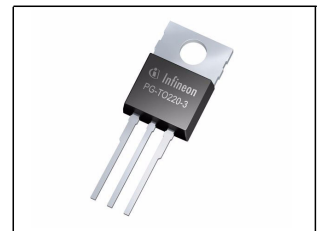

Application

- All kinds of resistive, inductive and capacitive loads in switching or linear applications
- μ C compatible power switch for 12 V and 24 V DC applications
- Replaces electromechanical relays and discrete circuits

General Description

N channel vertical power FET in Smart SIPMOS[®] chip on chip technology. Providing embedded protection functions.

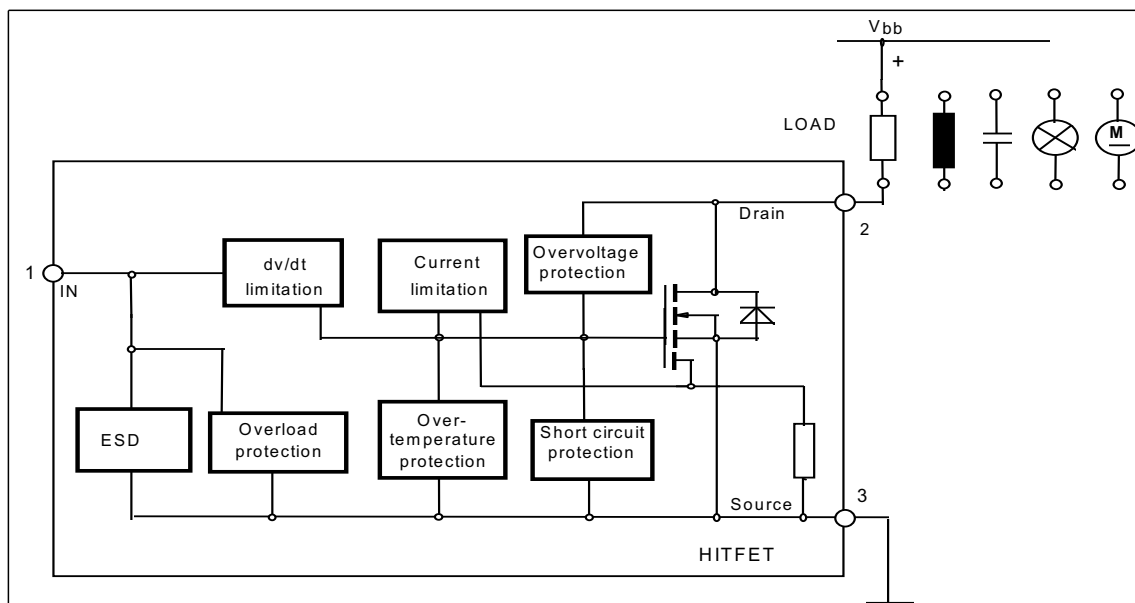

Maximum Ratings at $T_j = 25\text{ °C}$ unless otherwise specified

| Parameter | Symbol | Value | Unit |
|--|--------------|-------------------------------|------|
| Drain source voltage | V_{DS} | 60 | V |
| Drain source voltage for short circuit protection | $V_{DS(SC)}$ | 32 | |
| Continuous input current ¹⁾ -0.2V $\leq V_{IN} \leq$ 10V $V_{IN} < -0.2V$ or $V_{IN} > 10V$ | I_{IN} | no limit $ I_{IN} \leq 2$ | mA |
| Operating temperature | T_j | - 40 ... +150 | °C |
| Storage temperature | T_{stg} | - 55 ... +150 | |
| Power dissipation $T_C = 25\text{ °C}$ | P_{tot} | 149 | W |
| Unclamped single pulse inductive energy $I_{D(ISO)} = 12\text{ A}$ | E_{AS} | 4000 | mJ |
| Electrostatic discharge voltage (Human Body Model) according to MIL STD 883D, method 3015.7 and EOS/ESD assn. standard S5.1 - 1993 | V_{ESD} | 3000 | V |
| Load dump protection $V_{LoadDump}^{2)} = V_A + V_S$ $V_{IN} = \text{low or high}; V_A = 13.5\text{ V}$ $t_d = 400\text{ ms}, R_l = 2\ \Omega, I_D = 0,5 \cdot 12\text{ A}$ $t_d = 400\text{ ms}, R_l = 2\ \Omega, I_D = 12\text{ A}$ | V_{LD} | 100 84 | |

Thermal resistance

| | | | |
|---|------------|------|-----|
| junction - case: | R_{thJC} | 0.84 | K/W |
| junction - ambient: | R_{thJA} | 75 | |
| SMD version, device on PCB: ³⁾ | R_{thJA} | 45 | |

¹⁾ In case of thermal shutdown a minimum sensor holding current of 500 μA has to be guaranteed (see also page 3).

²⁾ $V_{LoadDump}$ is setup without the DUT connected to the generator per ISO 7637-1 and DIN 40839

³⁾ Device on 50mm*50mm*1.5mm epoxy PCB FR4 with 6cm² (one layer, 70 μm thick) copper area for Drain connection. PCB mounted vertical without blown air.

Electrical Characteristics

| Parameter at $T_j=25^\circ\text{C}$, unless otherwise specified | Symbol | Values | | | Unit |
|--|--------------|------------|----------|----------|------------------|
| | | min. | typ. | max. | |
| Characteristics | | | | | |
| Drain source clamp voltage $T_j = -40 \dots +150^\circ\text{C}$, $I_D = 10 \text{ mA}$ | $V_{DS(AZ)}$ | 60 | - | 73 | V |
| Off state drain current $V_{DS} = 32 \text{ V}$, $T_j = -40\dots+150^\circ\text{C}$, $V_{IN} = 0 \text{ V}$ | I_{DSS} | - | - | 20 | μA |
| Input threshold voltage $I_D = 2,7 \text{ mA}$ | $V_{IN(th)}$ | 1.3 | 1.7 | 2.2 | V |
| Input current - normal operation, $I_D < I_{D(lim)}$: $V_{IN} = 10 \text{ V}$ | $I_{IN(1)}$ | - | 35 | 100 | μA |
| Input current - current limitation mode, $I_D = I_{D(lim)}$: $V_{IN} = 10 \text{ V}$ | $I_{IN(2)}$ | - | 270 | 500 | |
| Input current - after thermal shutdown, $I_D = 0 \text{ A}$: $V_{IN} = 10 \text{ V}$ | $I_{IN(3)}$ | 1000 | 2500 | 4000 | |
| Input holding current after thermal shutdown ¹⁾ $T_j = 25^\circ\text{C}$ $T_j = 150^\circ\text{C}$ | $I_{IN(H)}$ | 500 300 | - - | - - | |
| On-state resistance $V_{IN} = 5 \text{ V}$, $I_D = 12 \text{ A}$, $T_j = 25^\circ\text{C}$ $V_{IN} = 5 \text{ V}$, $I_D = 12 \text{ A}$, $T_j = 150^\circ\text{C}$ | $R_{DS(on)}$ | - - | 31 52 | 34 68 | $\text{m}\Omega$ |
| On-state resistance $V_{IN} = 10 \text{ V}$, $I_D = 12 \text{ A}$, $T_j = 25^\circ\text{C}$ $V_{IN} = 10 \text{ V}$, $I_D = 12 \text{ A}$, $T_j = 150^\circ\text{C}$ | $R_{DS(on)}$ | - - | 25 45 | 28 56 | |
| Nominal load current (ISO 10483) $V_{IN} = 10 \text{ V}$, $V_{DS} = 0.5 \text{ V}$, $T_C = 85^\circ\text{C}$ | $I_{D(ISO)}$ | 12 | - | - | A |

¹⁾If the input current is limited by external components, low drain currents can flow and heat the device.
Auto restart behaviour can occur.

Electrical Characteristics

| Parameter at $T_j=25^\circ\text{C}$, unless otherwise specified | Symbol | Values | | | Unit |
|---|--------|--------|------|------|------|
| | | min. | typ. | max. | |

Characteristics

| | | | | | |
|---|--------------|----|-----|----|---|
| Initial peak short circuit current limit $V_{IN} = 10\text{ V}$, $V_{DS} = 12\text{ V}$ | $I_{D(SCp)}$ | - | 100 | - | A |
| Current limit ¹⁾ $V_{IN} = 10\text{ V}$, $V_{DS} = 12\text{ V}$, $t_m = 350\ \mu\text{s}$, $T_j = -40\dots+150\ ^\circ\text{C}$ | $I_{D(lim)}$ | 25 | 35 | 50 | |

Dynamic Characteristics

| | | | | | |
|---|--------------------|---|----|-----|------------------|
| Turn-on time V_{IN} to 90% I_D : $R_L = 2,2\ \Omega$, $V_{IN} = 0$ to 10 V , $V_{bb} = 12\text{ V}$ | t_{on} | - | 40 | 100 | μs |
| Turn-off time V_{IN} to 10% I_D : $R_L = 2,2\ \Omega$, $V_{IN} = 10$ to 0 V , $V_{bb} = 12\text{ V}$ | t_{off} | - | 70 | 170 | |
| Slew rate on 70 to 50% V_{bb} : $R_L = 2,2\ \Omega$, $V_{IN} = 0$ to 10 V , $V_{bb} = 12\text{ V}$ | $-dV_{DS}/dt_{on}$ | - | 1 | 3 | V/ μs |
| Slew rate off 50 to 70% V_{bb} : $R_L = 2,2\ \Omega$, $V_{IN} = 10$ to 0 V , $V_{bb} = 12\text{ V}$ | dV_{DS}/dt_{off} | - | 1 | 3 | |

Protection Functions ²⁾

| | | | | | |
|--|----------|-------------|--------|--------|------------------|
| Thermal overload trip temperature | T_{jt} | 150 | 165 | - | $^\circ\text{C}$ |
| Unclamped single pulse inductive energy $I_D = 12\text{ A}$, $T_j = 25\ ^\circ\text{C}$, $V_{bb} = 32\text{ V}$ $I_D = 12\text{ A}$, $T_j = 150\ ^\circ\text{C}$, $V_{bb} = 32\text{ V}$ | E_{AS} | 4000 900 | - - | - - | mJ |

Inverse Diode

| | | | | | |
|--|----------|---|------|---|---|
| Inverse diode forward voltage $I_F = 5*12\text{A}$, $t_m = 300\ \mu\text{s}$, $V_{IN} = 0\text{ V}$ | V_{SD} | - | 1.13 | - | V |
|--|----------|---|------|---|---|

¹Device switched on into existing short circuit (see diagram Determination of $I_{D(lim)}$). If the device is in on condition and a short circuit occurs, these values might be exceeded for max. 50 μs .

²Integrated protection functions are designed to prevent IC destruction under fault conditions described in the data sheet. Fault conditions are considered as "outside" normal operating range. Protection functions are not designed for continuous repetitive operation.

Block Diagramm

Terms

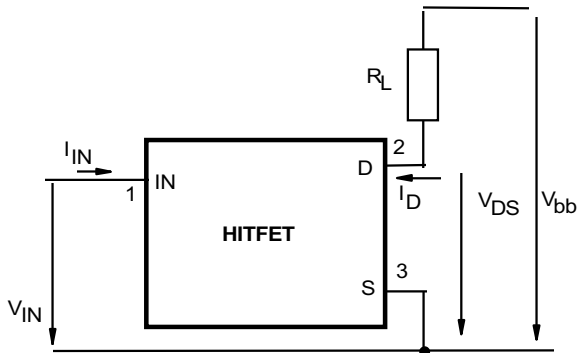

Inductive and overvoltage output clamp

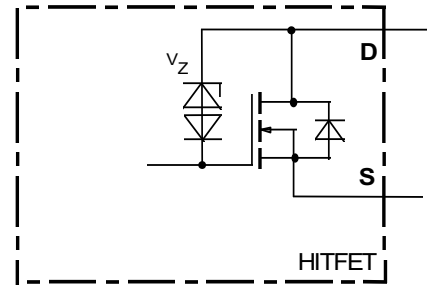

Input circuit (ESD protection)

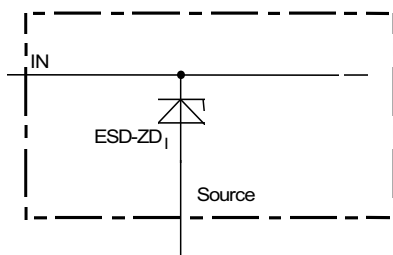

ESD zener diodes are not designed for DC current $> 2 \text{ mA}$ @ $V_{IN} > 10 \text{ V}$.

Short circuit behaviour

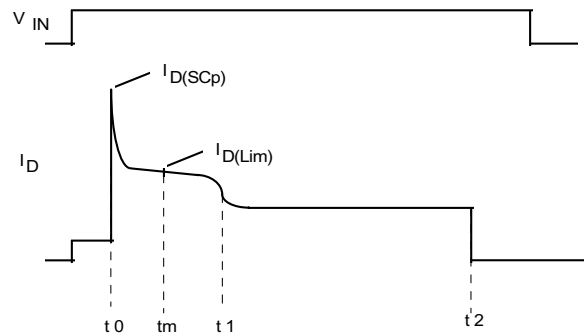

- t_0 : Turn on into a short circuit
- t_m : Measurementpoint for $I_{D(Lim)}$
- t_1 : Activation of the fast temperature sensor and regulation of the drain current to a level where the junction temperature remains constant.
- t_2 : Thermal shutdown caused by the second temperature sensor, achieved by an integrating measurement.

Maximum allowable power dissipation

$P_{tot} = f(T_c)$

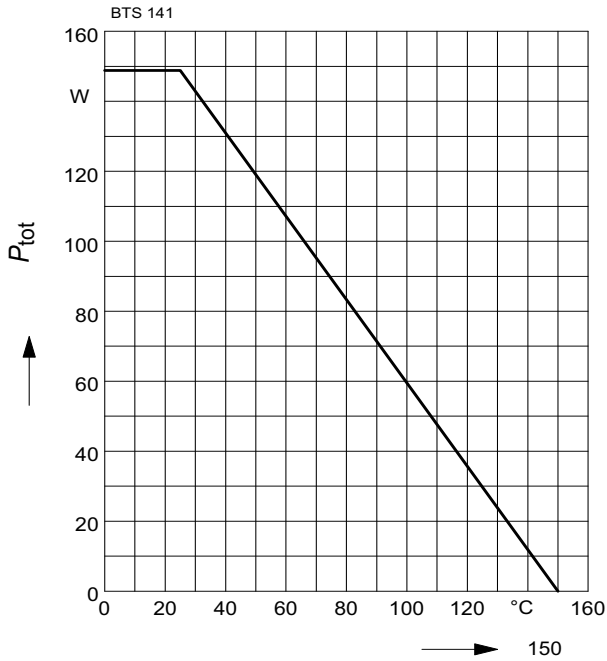

On-state resistance

$R_{ON} = f(T_j); I_D=12A; V_{IN}=10V$

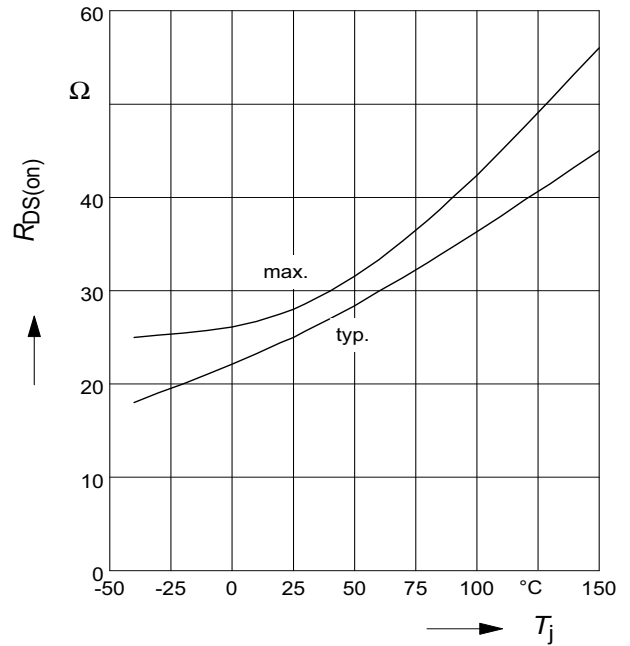

On-state resistance

$R_{ON} = f(T_j); I_D= 12A; V_{IN}=5V$

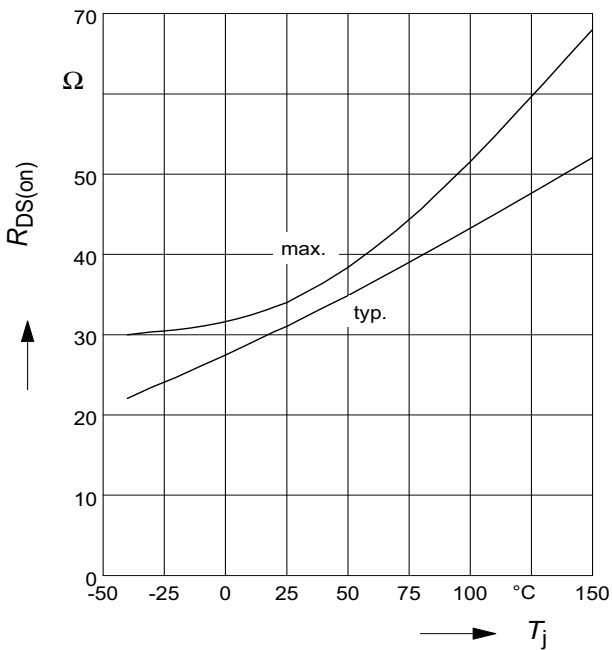

Typ. input threshold voltage

$V_{IN(th)} = f(T_j); I_D=2,7mA; V_{DS}=12V$

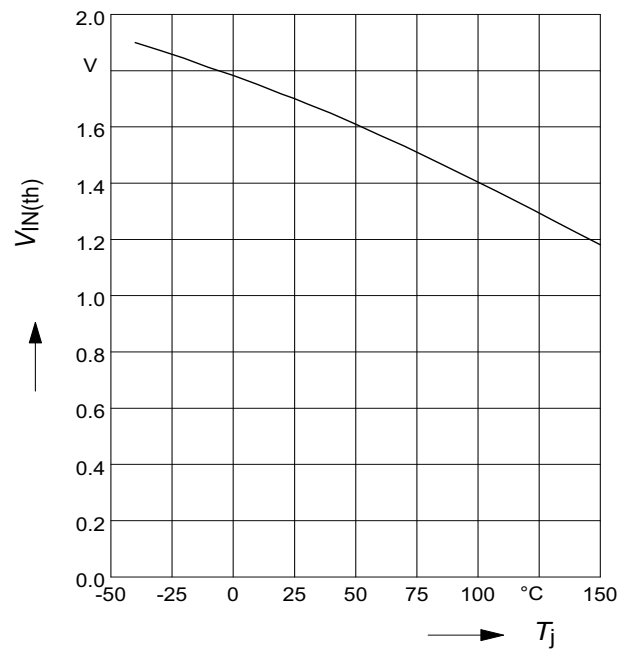

Typ. transfer characteristics

$I_D = f(V_{IN}); V_{DS}=12V; T_j=25^\circ C$

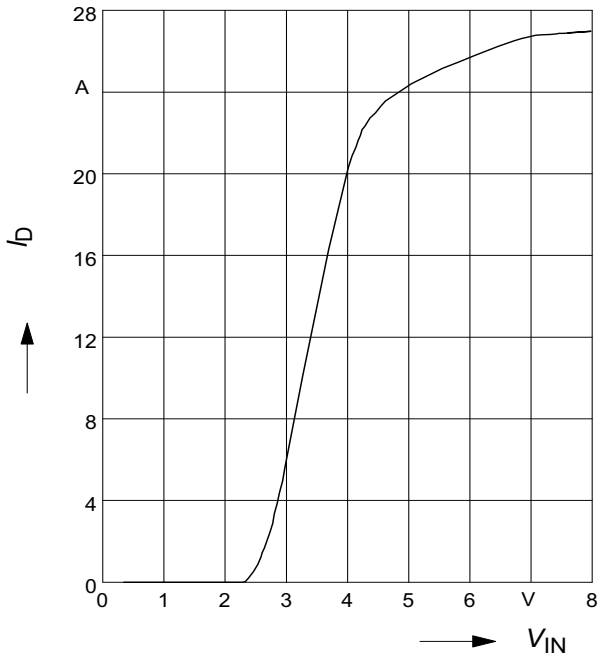

Typ. output characteristic

$I_D = f(V_{DS}); T_j=25^\circ C$

Parameter: V_{IN}

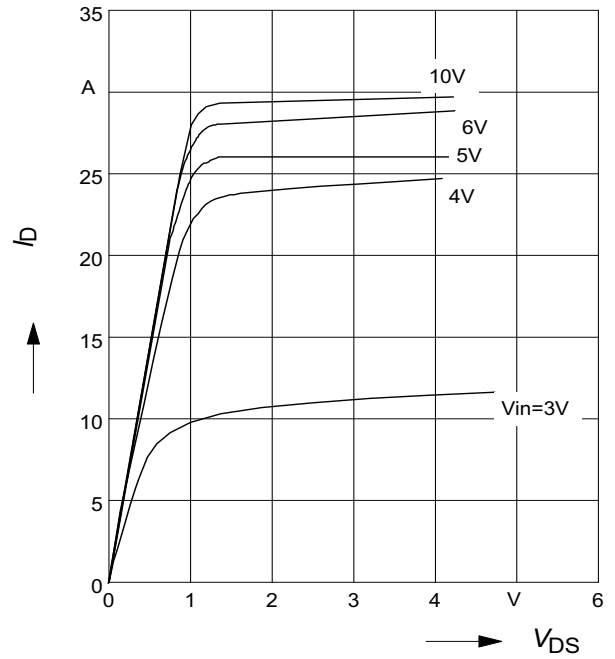

Transient thermal impedance

$Z_{thJC} = f(t_p)$

parameter : $D = t_p/T$

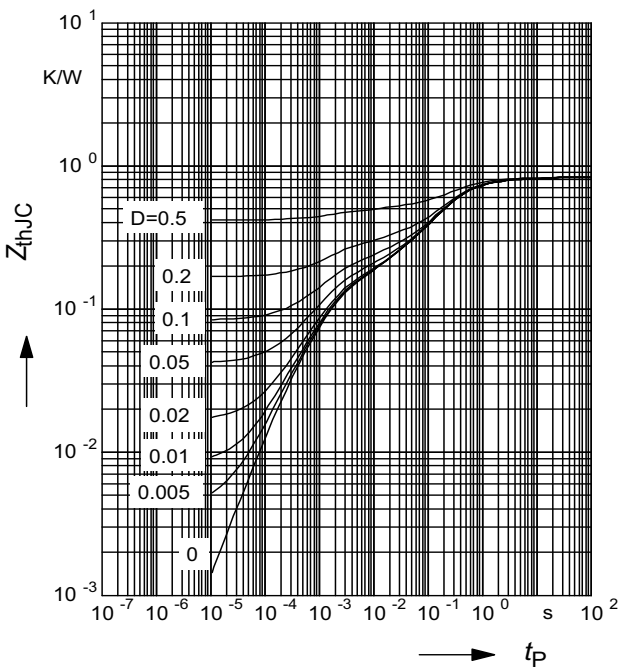

Application examples:

Status signal of thermal shutdown by monitoring input current

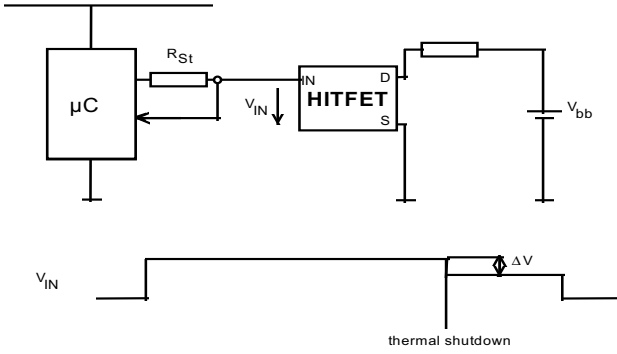

$$\Delta V = R_{ST} * I_{N(3)}$$

1 Package Outlines

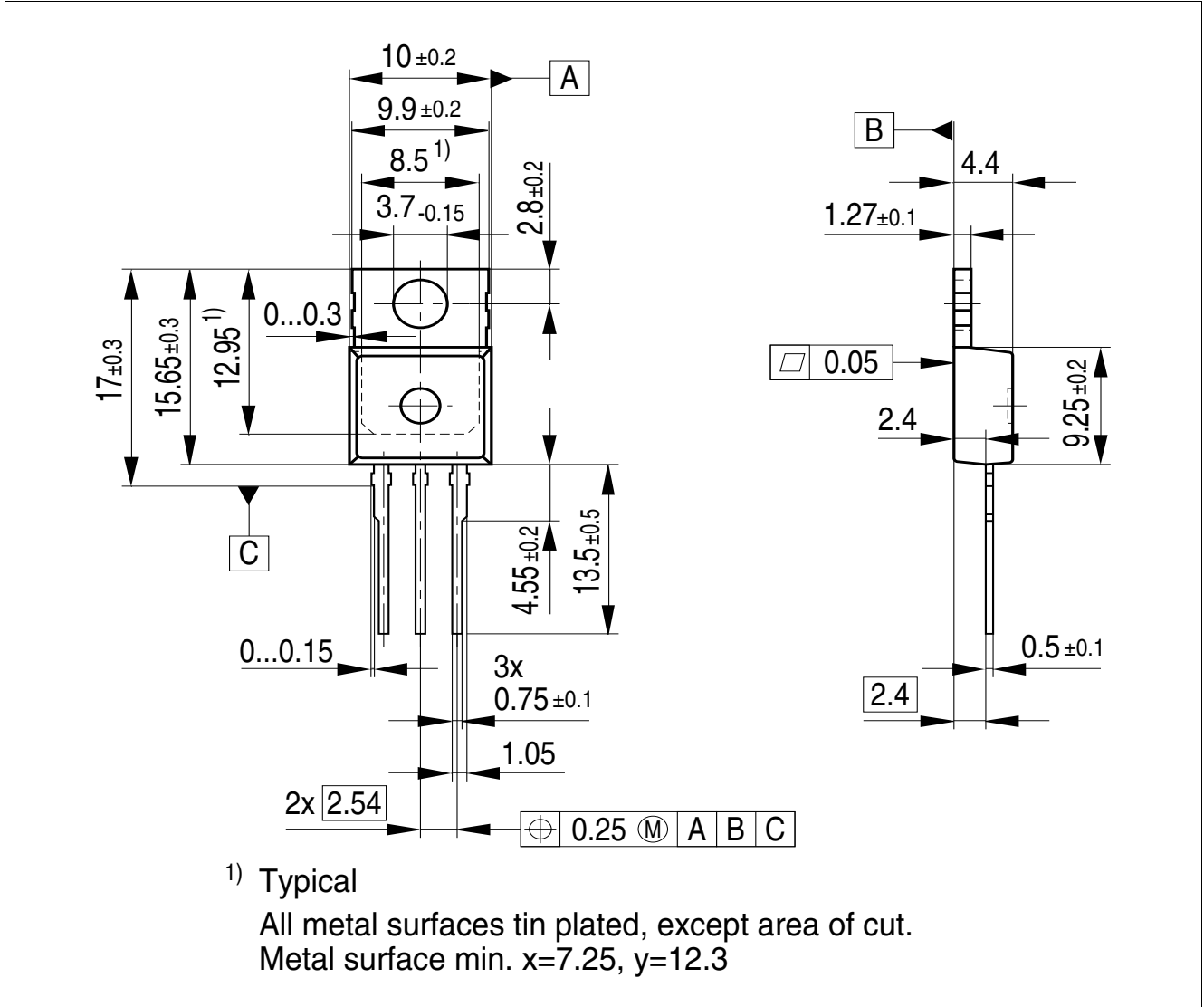

Figure 1 PG-TO220-3-1

To meet the world-wide customer requirements for environmentally friendly products and to be compliant with government regulations the device is available as a green product. Green products are RoHS-Compliant (i.e Pb-free finish on leads and suitable for Pb-free soldering according to IPC/JEDEC J-STD-020).

You can find all of our packages, sorts of packing and others in our Infineon Internet Page "Products": <http://www.infineon.com/products>.

Dimensions in mm

2 Revision History

| Version | Date | Changes |
|----------|------------|--|
| Rev. 1.4 | 2012-07-11 | released through hole automotive green Datasheet Package drawing update, removed staggered package added through hole version in green package |
| Rev. 1.3 | 2008-12-10 | Package drawing update |
| Rev. 1.2 | 2008-08-11 | Package information updated, removed through hole version |
| Rev. 1.1 | 2008-02-22 | Package parameter (humidity and climatic) removed in Maximum ratings AEC icon and RoHS icon added Green product and AEC qualified added to feature list added Protection footnote on Page 4 and changed front page general description Package information updated to green Green explanation added |
| Rev. 1.0 | 2000-05-19 | released production version |

Edition 2012-07-11

**Published by
Infineon Technologies AG
81726 Munich, Germany**

**© Infineon Technologies AG 2012.
All Rights Reserved.**

Legal Disclaimer

The information given in this document shall in no event be regarded as a guarantee of conditions or characteristics ("Beschaffenhheitsgarantie"). With respect to any examples or hints given herein, any typical values stated herein and/or any information regarding the application of the device, Infineon Technologies hereby disclaims any and all warranties and liabilities of any kind, including without limitation warranties of non-infringement of intellectual property rights of any third party.

Information

For further information on technology, delivery terms and conditions and prices please contact your nearest Infineon Technologies Office (www.infineon.com).

Warnings

Due to technical requirements components may contain dangerous substances. For information on the types in question please contact your nearest Infineon Technologies Office.

Infineon Technologies Components may only be used in life-support devices or systems with the express written approval of Infineon Technologies, if a failure of such components can reasonably be expected to cause the failure of that life-support device or system, or to affect the safety or effectiveness of that device or system. Life support devices or systems are intended to be implanted in the human body, or to support and/or maintain and sustain and/or protect human life. If they fail, it is reasonable to assume that the health of the user or other persons may be endangered.