

阅读申明

- 1.本站收集的数据手册和产品资料都来自互联网，版权归原作者所有。如读者和版权方有任何异议请及时告之，我们将妥善解决。
- 2.本站提供的中文数据手册是英文数据手册的中文翻译，其目的是协助用户阅读，该译文无法自动跟随原稿更新，同时也可能存在翻译上的不当。建议读者以英文原稿为参考以便获得更精准的信息。
- 3.本站提供的产品资料，来自厂商的技术支持或者使用者的心得体会等，其内容可能存在描述上的差异，建议读者做出适当判断。
- 4.如需与我们联系，请发邮件到marketing@iczoom.com，主题请标有“数据手册”字样。

Read Statement

1. The datasheets and other product information on the site are all from network reference or other public materials, and the copyright belongs to the original author and original published source. If readers and copyright owners have any objections, please contact us and we will deal with it in a timely manner.
2. The Chinese datasheets provided on the website is a Chinese translation of the English datasheets. Its purpose is for reader's learning exchange only and do not involve commercial purposes. The translation cannot be automatically updated with the original manuscript, and there may also be improper translations. Readers are advised to use the English manuscript as a reference for more accurate information.
3. All product information provided on the website refer to solutions from manufacturers' technical support or users the contents may have differences in description, and readers are advised to take the original article as the standard.
4. If you have any questions, please contact us at marketing@iczoom.com and mark the subject with "Datasheets" .

PR2 Relay Base for: – Industrial DPDT or 4PDT Relays

Universal Modular System

The 27 mm* (1.063 in.) wide PR2 relay base range is a modular system consisting of PR2-B... relay bases, robust REL-IR... electromechanical industrial relays with DPDT and 4PDT contacts, and a comprehensive range of accessories. These include:

- Plug-in input/interference suppression modules
- Relay retaining bracket with labeling field and eject function
- Labels
- Continuous jumpers

Depending on the application, complete coupling relays can be created, which are optimized in terms of cost and function.

Base Versions

The relay bases are available in three versions - the flat 2/2 level PR2-BSC2 type with screw connections, and the "logical" 1/3 level PR2-BSC3 with screw connections and PR2-BSP3 with spring-cage connections. The logical versions have coil and contact connections that are located opposite one another and thus meet the requirements of modern control cabinet concepts with clear isolation of control signals and load.

Robust, Cost-Effective Industrial Relays

Industrial relays are used in many sectors of industry due to their robust structure, which has 2.6 mm (0.102 in.) flat pins. The main features of the REL/IR... series include the fully automated manufacture of products in conjunction with the high degree of product stability and global availability. The following versions are available:





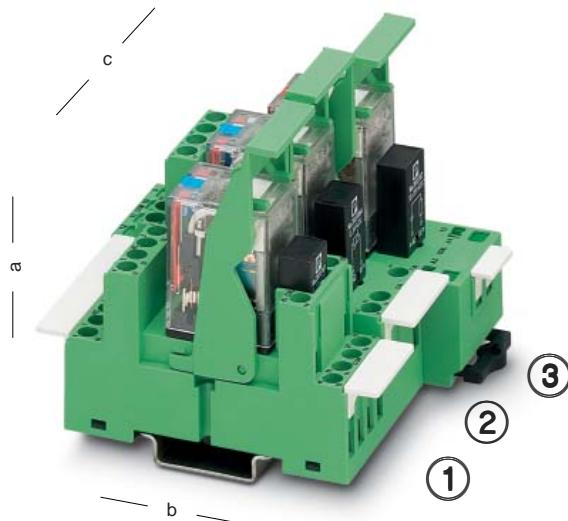

- With two 10 A 2PDT contacts
- With four 5 A 4PDT contacts
- In all popular AC and DC coil voltages

Considerably wider and more expensive miniature contactors can thus be replaced cost-effectively in many applications without adversely affecting machine or system operation. All industrial relays have the following standard features:

- Manual test key (AC coil = red key, DC coil = blue key)
- Mechanical switch setting display
- LED status indicators
- Free-wheeling diode (only DC types)
- Power contacts with solid gold coating (only types with 4PDT contacts)

*) Spring-cage version is 31 mm (1.220 in.) wide



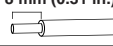
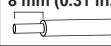
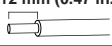

	①	②	③
	PR2-BSC2...	PR2-BSC3...	PR2-BSP3...
Nominal voltage U ¹⁾	300 V AC	300 V AC	300 V AC
Nominal current I ¹⁾	12 A	12 A	10 A
Conductor cross section			
– Solid	2 x 2.5 mm ²	2 x 2.5 mm ²	2 x 1.5 mm ²
– Flexible	2 x 2.5 mm ²	2 x 2.5 mm ²	2 x 1.5 mm ²
American Wire Gauge	2 x 14 AWG	2 x 14 AWG	2 x 16 AWG
Connection type	 M 3	 M 3	 3)
Approvals ²⁾			
Stripping length	8 mm (0.31 in.) 	8 mm (0.31 in.) 	12 mm (0.47 in.) 
Height (a) with retaining bracket: – EL2-P35	84 mm (3.307 in.)	86 mm (3.386 in.)	84 mm (3.307 in.)
Depth (b)	75 mm (2.953 in.)	78.5 mm (3.091 in.)	95 mm (3.740 in.)
Width (c)	27 mm (1.063 in.)	27 mm (1.063 in.)	31 mm (1.220 in.)
Ambient temperature	-25°C...+85°C (-13°F...+185°F)	-25°C...+85°C (-13°F...+185°F)	-25°C...+85°C (-13°F...+185°F)

¹⁾ The maximum electrical data is relay dependent.

²⁾ Details on request.

³⁾ Two spring-cage connections per terminal point.

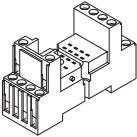
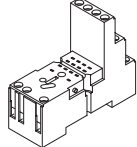
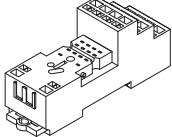
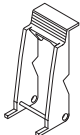
PR2 Relay Base for Industrial DPDT or 4PDT Relays

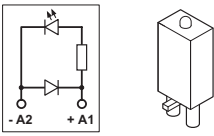
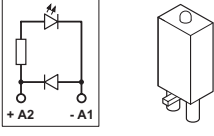
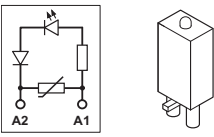
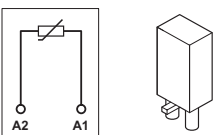
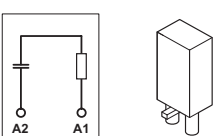
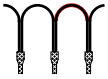
Description	Type	Order No.	Pcs. Pkt.
<p>PR2-B relay base, for REL-IR Industrial DPDT or 4PDT Relays, 2/2 level version, screw connections, optional connection of input/interference suppression module, for mounting on , including MP2 markers, 10 pcs. per pack</p>	PR2-BSC2/4x21	28 33 56 3	10
<p>PR2-B relay base, for REL-IR Industrial DPDT or 4PDT Relays, 1/3 level version, screw connections, optional connection of input/interference suppression module, for mounting on , including MP2 markers, 10 pcs. per pack</p>	PR2-BSC3/4x21	28 33 57 6	10
<p>PR2-B relay base, for REL-IR Industrial DPDT or 4PDT Relays, 1/3 level version, spring-cage connections, optional connection of input/interference suppression module, for mounting on , including MP1 markers, 10 pcs. per pack</p>	PR2-BSP3/4x21	28 33 58 9	10
<p>Relay retaining bracket, with eject function and integrated device marking area (8 x 25 mm [0.315 x 0.984 in.]), suitable for PR2 relay base: – For 35 mm (1.378 in.) high industrial relays</p> 	EL2-P35	28 33 59 2	10
<p>Device marker: – Suitable for PR2-BSP, 6 x 15 mm (0.236 x 0.591 in.) marking area – Suitable for PR2-BSC, 9 x 25 mm (0.354 x 0.984 in.) marking area</p> 	MP1 MP2	28 33 63 1 28 33 64 4	10 10
<p>Plug-in module, for mounting on PR1 and PR2, with free-wheeling diode and yellow LED, polarity: A1 +, A2 – Input voltage: – 12 - 24 V DC ±20% – 48 - 60 V DC ±20% – 110 V DC ±20%</p> 	LDP-12-24DC ¹⁾ LDP-48-60DC ¹⁾ LDP-110DC ¹⁾	28 33 65 7 28 33 66 0 28 33 67 3	10 10 10
<p>Plug-in module, for mounting on PR1 and PR2, with free-wheeling diode and yellow LED, polarity: A1 –, A2 + (Japanese standard) Input voltage: – 12 - 24 V DC ±20% – 48 - 60 V DC ±20% – 110 V DC ±20%</p> 	LDM-12-24DC ¹⁾ LDM-48-60DC ¹⁾ LDM-110DC ¹⁾	28 33 68 6 28 33 69 9 28 33 70 9	10 10 10
<p>Plug-in module, for mounting on PR1 and PR2, with varistor and yellow LED, input voltage: – 12 - 24 V AC/DC ±20% – 48 - 60 V AC/DC ±20% – 120 - 230 V AC/110 V DC ±20%</p> 	LV-12-24UC (30 V varistor) LV-48-60UC (75 V varistor) LV-120-230AC/110 DC (275 V varistor)	28 33 71 2 28 33 72 5 28 33 73 8	10 10 10
<p>Plug-in module, for mounting on PR1 and PR2, with varistor Input voltage: – 12 - 24 V AC/DC ±20% – 48 - 60 V AC/DC ±20% – 120 - 230 V AC/DC ±20%</p> 	V-12-24UC (30 V varistor) V-48-60UC (75 V varistor) V-120-230UC (275 V varistor)	28 33 86 4 28 33 87 7 28 33 88 0	10 10 10
<p>Plug-in module, for mounting on PR1 and PR2, with RC element Input voltage: – 12 - 24 V AC/DC ±20% – 48 - 60 V AC/DC ±20% – 120 - 230 V AC/DC ±20%</p> 	RC-12-24UC (220 nF/100 Ω) RC-48-60UC (220 nF/220 Ω) RC-120-230UC (100 nF/470 Ω)	28 33 74 1 28 33 75 4 28 33 76 7	10 10 10
<p>Wire jumper, 50-pos., can be separated, maximum jumpering distance of 60 mm (2.36 in.), 0.5 mm² (20 AWG), insulation: – Blue – Black – Gray</p> 	DB 50-90 BU DB 50-90 BK DB 50-90 GY	28 21 18 0 28 20 91 6 28 20 92 9	1 1 1

¹⁾Might not be required, as LED and free-wheeling diode are already integrated in the REL-IR/LD... relays.

Plug-In Industrial Relays With DPDT Contacts, Suitable for PR2 Relay Base

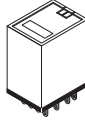
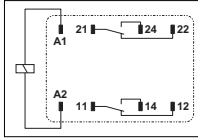
Description	
<p>Plug-in industrial relays¹⁾ with power contacts, DPDT contacts, test key, status LED, free-wheeling diode, mechanical switch setting display, polarity: A1 +, A2 - Coil voltage: - 12 V DC - 24 V DC - 48 V DC - 110 V DC</p>	
<p>Plug-in industrial relays¹⁾ with power contacts, DPDT contacts, test key, status LED, free-wheeling diode, mechanical switch setting display, polarity: A1 -, A2 + (Japanese standard) Coil voltage: - 12 V DC - 24 V DC - 48 V DC - 110 V DC</p>	 <p>Representation without LED and free-wheeling diode.</p> <p>Contacts 21, 22, and 24 are led to relay base connections 41, 42, and 44.</p>
<p>Plug-in industrial relays¹⁾ with power contacts, DPDT contacts, test key, status LED, mechanical switch setting display Coil voltage: - 24 V AC - 120 V AC - 230 V AC</p>	

Technical Data

Coil Side DC Coils

Nominal input voltage U_N	12 V DC	24 V DC	48 V DC	110 V DC
Permissible range (with reference to U_N)	See diagram on page 5			
Typical input current at U_N	75 mA	38 mA	19 mA	10 mA
Typical response time at U_N	13 ms	13 ms	13 ms	13 ms
Typical release time at U_N	5 ms	5 ms	5 ms	5 ms
DC coil resistance at 20°C (68°F)	160 Ω ±15%	630 Ω ±15%	2560 Ω ±15%	11100 Ω ±15%

Coil Side AC Coils (50 Hz/60 Hz)

Nominal input voltage U_N	24 V AC	120 V AC	230 V AC
Permissible range (with reference to U_N)	See diagram on page 5		
Typical input current at U_N (50 Hz/60 Hz)	54 mA/46 mA	11 mA/9 mA	5 mA/4 mA
Typical response time at U_N (depending on phase relation)	4 - 10 ms	4 - 10 ms	4 - 10 ms
Typical release time at U_N (depending on phase relation)	3 - 12 ms	3 - 12 ms	3 - 12 ms
DC coil resistance at 20°C (68°F)	180 Ω ±15%	4430 Ω ±15%	18790 Ω ±15%

Contact Side

Contact type	REL-IR...2x21
Contact material	Single contact, 2 PDT contacts
Maximum switching voltage	Ag
Minimum switching voltage	250 V AC/125 V DC
Limiting continuous current	5 V
Maximum inrush current	10 A
Minimum switching current	20 A (15 ms)
Maximum shutdown power (ohmic load)	1 mA
Minimum switching power	2500 VA
	For additional data, see diagram on page 5
	5 mW

General Data

Test voltage:	Winding/contact	2 kV, 50 Hz, 1 minute
	Contact/contact	2 kV, 50 Hz, 1 minute
Ambient temperature		-55°C to +70°C (-67°F to +158°F)
Nominal operating mode		100% ED
Mechanical service life		5 x 10 ⁷ cycles
Electrical service life		See diagram on page 5
Standards/specifications		IEC 60 664/IEC 60 664 A/DIN VDE 0110, degree of pollution 2, Surge Voltage Category II
Approvals		UL; CSA; VDE
Mounting position/mounting		Any/can be mounted without spacing

¹⁾Further voltage versions, lockable test key, etc. on request.

Type	Order No.	Pcs. Pkt.
REL-IR/LDP-12DC/2x21	28 34 01 2	10
REL-IR/LDP-24DC/2x21	28 34 02 5	10
REL-IR/LDP-48DC/2x21	28 34 03 8	10
REL-IR/LDP-110DC/2x21	28 34 04 1	10
REL-IR/LDM-12DC/2x21	28 34 15 1	10
REL-IR/LDM-24DC/2x21	28 34 16 4	10
REL-IR/LDM-48DC/2x21	28 34 17 7	10
REL-IR/LDM-110DC/2x21	28 34 18 0	10
REL-IR/L-24AC/2x21	28 34 05 4	10
REL-IR/L-120AC/2x21	28 34 06 7	10
REL-IR/L-230AC/2x21	28 34 07 0	10

Plug-In Industrial Relays With 4PDT Contacts, Suitable for PR2 Relay Base

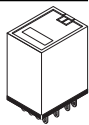
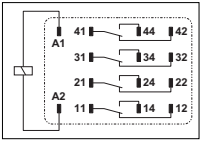
Description	Type	Order No.	Pcs. Pkt.
<p>Plug-in industrial relays¹⁾ with power contacts and solid gold coating, 4PDT contacts, test key, status LED, free-wheeling diode, mechanical switch setting display, polarity: A1 +, A2 - Coil voltage: - 12 V DC - 24 V DC - 48 V DC - 110 V DC</p>	 		
<p>Plug-in industrial relays¹⁾ with power contacts and solid gold coating, 4PDT contacts, test key, status LED, free-wheeling diode, mechanical switch setting display, polarity: A1 -, A2 + (Japanese standard) Coil voltage: - 12 V DC - 24 V DC - 48 V DC - 110 V DC</p>	<p>Representation without LED and free-wheeling diode.</p>	<p>REL-IR/LDP-12DC/4x21AU 28 34 08 3 10 REL-IR/LDP-24DC/4x21AU 28 34 09 6 10 REL-IR/LDP-48DC/4x21AU 28 34 10 6 10 REL-IR/LDP-110DC/4x21AU 28 34 11 9 10</p>	
<p>Plug-in industrial relays¹⁾ with power contacts and solid gold coating, 4PDT contacts, test key, status LED, mechanical switch setting display Coil voltage: - 24 V AC - 120 V AC - 230 V AC</p>		<p>REL-IR/LDM-12DC/4x21AU 28 34 19 3 10 REL-IR/LDM-24DC/4x21AU 28 34 20 3 10 REL-IR/LDM-48DC/4x21AU 28 34 21 6 10 REL-IR/LDM-110DC/4x21AU 28 34 22 9 10</p>	
<p>Plug-in industrial relays¹⁾ with power contacts and solid gold coating, 4PDT contacts, test key, status LED, mechanical switch setting display Coil voltage: - 24 V AC - 120 V AC - 230 V AC</p>		<p>REL-IR/L-24AC/4x21AU 28 34 12 2 10 REL-IR/L-120AC/4x21AU 28 34 13 5 10 REL-IR/L-230AC/4x21AU 28 34 14 8 10</p>	
Technical Data			
<p>Coil Side DC Coils Nominal input voltage U_N Permissible range (with reference to U_N) Typical input current at U_N Typical response time at U_N Typical release time at U_N DC coil resistance at 20°C (68°F)</p>	<p>12 V DC 24 V DC 48 V DC 110 V DC See diagram on page 5 75 mA 38 mA 19 mA 10 mA 13 ms 13 ms 13 ms 13 ms 5 ms 5 ms 5 ms 5 ms 160 Ω ±15% 630 Ω ±15% 2560 Ω ±15% 11100 Ω ±15%</p>		
<p>Coil Side AC Coils (50 Hz/60 Hz) Nominal input voltage U_N Permissible range (with reference to U_N) Typical input current at U_N (50 Hz/60 Hz) Typical response time at U_N (depending on phase relation) Typical release time at U_N (depending on phase relation) DC coil resistance at 20°C (68°F)</p>	<p>24 V AC 120 V AC 230 V AC See diagram on page 5 54 mA/46 mA 11 mA/9 mA 5 mA/4 mA 4 - 10 ms 4 - 10 ms 4 - 10 ms 3 - 12 ms 3 - 12 ms 3 - 12 ms 180 Ω ±15% 4430 Ω ±15% 18790 Ω ±15%</p>		
<p>Contact Side Contact type Contact material Maximum switching voltage Minimum switching voltage Limiting continuous current Maximum inrush current Minimum switching current Maximum shutdown power (ohmic load) Minimum switching power</p>	<p>REL-IR...4x21AU Single contact, 4 PDT contacts AgNi + 3 μ Au 250 V AC/125 V DC 1 V 5 A 12 A (15 ms) 1 mA 1250 VA For additional data, see diagram on page 5 1 mW</p>	<p>250 V AC</p>	
<p>General Data Test voltage: Winding/contact Contact/contact Ambient temperature Nominal operating mode Mechanical service life Electrical service life Standards/specifications Approvals Mounting position/mounting</p>	<p>2 kV, 50 Hz, 1 minute 2 kV, 50 Hz, 1 minute -55°C to +70°C (-67°F to +158°F) 100% ED 5 x 10⁷ cycles See diagram on page 5 IEC 60 664/IEC 60 664 A/DIN VDE 0110, degree of pollution 2, Surge Voltage Category II UL; CSA; VDE Any/can be mounted without spacing</p>		

¹⁾Further voltage versions, lockable test key, etc. on request.

Diagrams for REL-IR... Industrial Relays

REL-IR...2x21 (DPDT Contacts)

Operating voltage range

$$T_u = T_{coil}$$

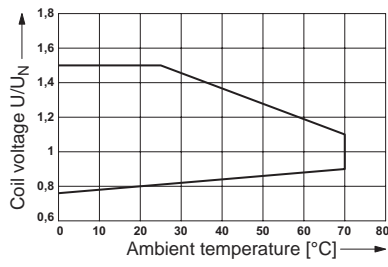

Shutdown power

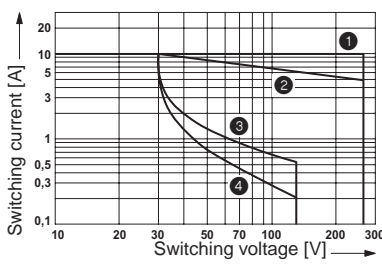

- ① AC, ohmic load
- ② AC, $\cos \varphi = 0.4$
- ③ DC, ohmic load
- ④ DC, $L/R = 7$ ms

Electrical service life

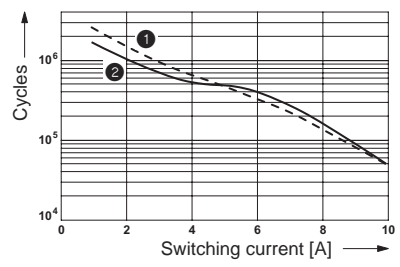

- ① 250 V AC, ohmic load
- ② 30 V DC, ohmic load

REL-IR...4x21AU (4PDT Contacts)

Operating voltage range

$$T_u = T_{coil}$$

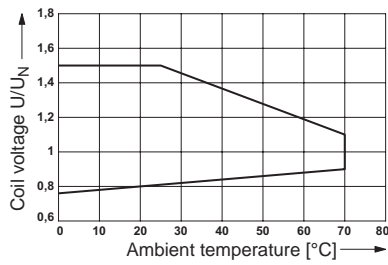

Shutdown power

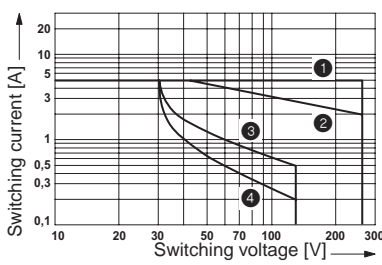

- ① AC, ohmic load
- ② AC, $\cos \varphi = 0.4$
- ③ DC, ohmic load
- ④ DC, $L/R = 7$ ms

Electrical service life

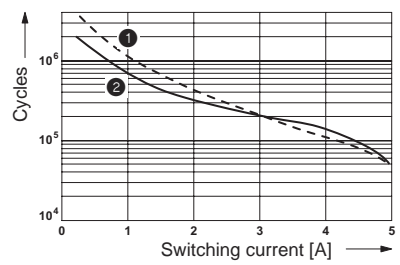

- ① 250 V AC, ohmic load
- ② 30 V DC, ohmic load