

阅读申明

- 1.本站收集的数据手册和产品资料都来自互联网，版权归原作者所有。如读者和版权方有任何异议请及时告之，我们将妥善解决。
- 2.本站提供的中文数据手册是英文数据手册的中文翻译，其目的是协助用户阅读，该译文无法自动跟随原稿更新，同时也可能存在翻译上的不当。建议读者以英文原稿为参考以便获得更精准的信息。
- 3.本站提供的产品资料，来自厂商的技术支持或者使用者的心得体会等，其内容可能存在描述上的差异，建议读者做出适当判断。
- 4.如需与我们联系，请发邮件到marketing@iczoom.com，主题请标有“数据手册”字样。

Read Statement

1. The datasheets and other product information on the site are all from network reference or other public materials, and the copyright belongs to the original author and original published source. If readers and copyright owners have any objections, please contact us and we will deal with it in a timely manner.
2. The Chinese datasheets provided on the website is a Chinese translation of the English datasheets. Its purpose is for reader's learning exchange only and do not involve commercial purposes. The translation cannot be automatically updated with the original manuscript, and there may also be improper translations. Readers are advised to use the English manuscript as a reference for more accurate information.
3. All product information provided on the website refer to solutions from manufacturers' technical support or users the contents may have differences in description, and readers are advised to take the original article as the standard.
4. If you have any questions, please contact us at marketing@iczoom.com and mark the subject with "Datasheets" .



Conforms to EN60204-1, EN292, and EN692
UL and C-UL listed, CSA and BG approved



H
safety monitoring relays

SR125SMS

Stop Motion Sensing Unit

- Power requirements—the SR125SMS will accept 24 VDC, 110 VAC, or 220 VAC
- Motion detection input—the SR125SMS detects the stop condition of all types of AC or DC motors by sensing the motor's back EMF across terminals Z1, Z2 and Z3
- Drive compatible—the SR125SMS will function with electronic motor control devices such as variable speed controllers, DC injection brakes, etc.
- Selectable speed limit—the SR125SMS has 1 N/O and 1 N/C outputs that are switched when motor speed reaches the adjustable preset limit (0.01 to 0.10 V) for the particular output
- Auxiliary output—the SR125SMS has 2 solid state auxiliary signaling outputs

A Go to the Engineering Guide
For in-depth information on safety standards and use.



OMRON SCIENTIFIC TECHNOLOGIES, INC.
USA Tel. 1/888/510-4357 Canada Tel. 1/866/986-6766

For the Latest Information
On the Internet: www.sti.com or www.omron.ca



■ Application

24VAC/DC, 110VAC, 230VAC

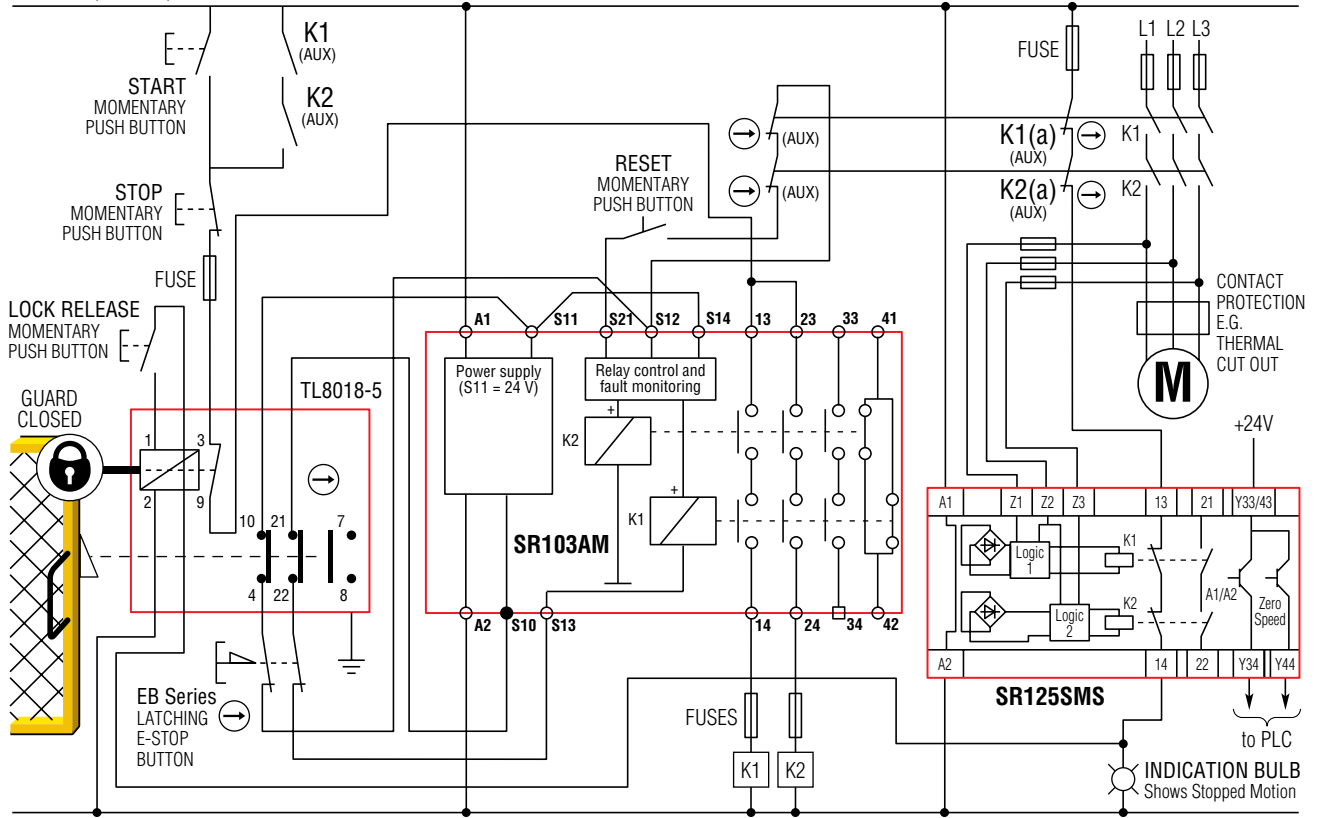

H
safety monitoring relays

 For a full explanation of the circuit operating principle and fault detection, see "Common Circuit Examples" in the Engineering Section of this catalog.

Operation

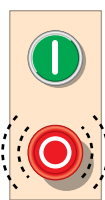

Stop signal to motor



SR125SMS detects back EMF of motor and senses when hazardous motion has ceased, then signals guard locking switch to unlock

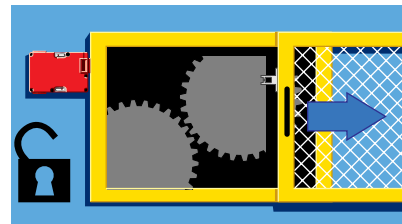
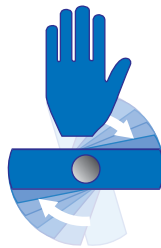

Guard locking switch unlocks guard allowing safe access to machine

Terminal Connections

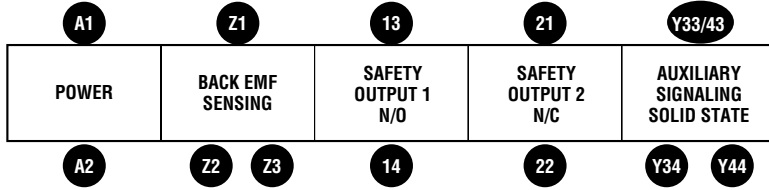

Block Diagram

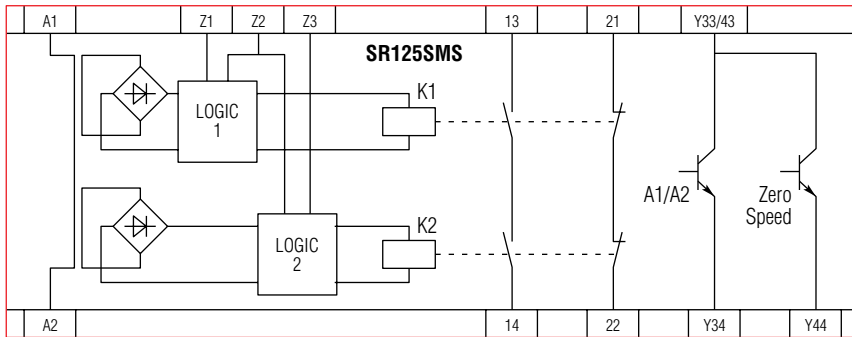

H
safety monitoring relays

Dimensions — mm/in.

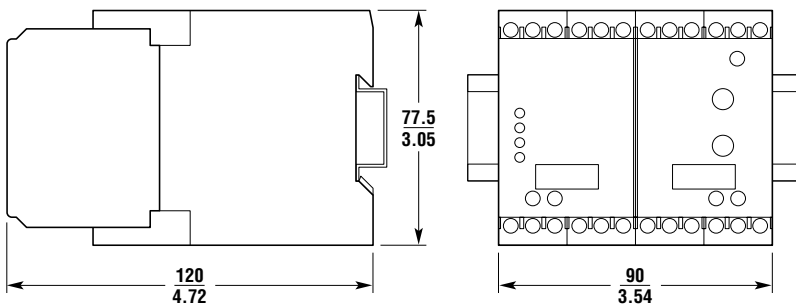

A Go to the Engineering Guide
For in-depth information on
safety standards and use.

■ Specifications

Electrical	All Models	SR125SMS00	SR125SMS02	SRS125SMS03
Power Supply:	±10%	24 VDC	110 VAC	220 VAC
Power Consumption:		≤3.5 W	≤7 VA	≤7.5 VA
Internal Fuse:	Electronic			
Safety Inputs:	Back EMF sensing between Z1 and Z2 and Z3			
Maximum Motor Voltage:	500 VAC (0 to 60 Hz)			
Detection Threshold:	0.01 V			
Relay Outputs:	1 N/O + 1 N/C switched at preset detection threshold			
Auxiliary Outputs:	2 solid state for signaling			
Max Switched AC:	Inductive AC-15, 1800 VA inrush, 180 VA maintained			
Max Switched DC:	Inductive DC-13, 1.2-1.5 A/24 V			
Min Switched Current/Voltage:	10 mA/17 V (provided that the contact has never been used with higher loads)			
Impulse Withstand Voltage:	4000 V			
Max Drop-Out Time:	n/a			
Max Output Fuse:	4 A slow-acting or 6 A fast-acting			
Reset Mode:	n/a			
Mechanical				
Mounting:	35 mm (1.38 in.) DIN rail			
Case Material:	Polyamide PA6.6			
Max Wire Size:	2 x 2.5 mm (14 AWG) stranded			
Weight:	AC: 600 g (21 oz.); DC: 500 g (18 oz.)			
Color:	Red with black body			
External Adjustment:	Motor speed preset via potentiometer			
Indication:	Green = Power On	Green = Channel 1 activated,		
	Green = Channel 2 activated	Green = CH1 + CH2 activated		
Environmental				
Enclosure Protection:	IP20 terminals, IP40 (NEMA 1) housing			
Operating Temperature:	-10 to 55°C (14 to 131°F)			
Compliance				
Standards:	EN1088, EN954-1, EN292, EN692, EN60204-1,			
Approvals/Listings:	CE-marked for all applicable directives, UL and C-UL, CSA, BG			
Safety Category:	Cat. 3 per EN954-1 (SR125SMS internal operation)			

Specifications are subject to change without notice.

Note: The safety contacts of the Omron STI switches are described as normally closed (N/C)—i.e., with the guard closed, actuator in place, and the machine able to be started.

■ Ordering

Model	Supply	Inputs	Outputs	Auxiliary	Part No.
SR125SMS00	24 VDC	Back EMF Sensing	1 N/O + 1 N/C	2 Solid State	44510-1250
SR125SMS02	110 VAC	Back EMF Sensing	1 N/O + 1 N/C	2 Solid State	44510-1252
SR125SMS03	230 VAC*	Back EMF Sensing	1 N/O + 1 N/C	2 Solid State	44510-1253

*230 VAC units are available on special order. Minimum quantities may apply.