

## 阅读申明

- 1.本站收集的数据手册和产品资料都来自互联网，版权归原作者所有。如读者和版权方有任何异议请及时告之，我们将妥善解决。
- 2.本站提供的中文数据手册是英文数据手册的中文翻译，其目的是协助用户阅读，该译文无法自动跟随原稿更新，同时也可能存在翻译上的不当。建议读者以英文原稿为参考以便获得更精准的信息。
- 3.本站提供的产品资料，来自厂商的技术支持或者使用者的心得体会等，其内容可能存在描述上的差异，建议读者做出适当判断。
- 4.如需与我们联系，请发邮件到marketing@iczoom.com，主题请标有“数据手册”字样。

## Read Statement

1. The datasheets and other product information on the site are all from network reference or other public materials, and the copyright belongs to the original author and original published source. If readers and copyright owners have any objections, please contact us and we will deal with it in a timely manner.
2. The Chinese datasheets provided on the website is a Chinese translation of the English datasheets. Its purpose is for reader's learning exchange only and do not involve commercial purposes. The translation cannot be automatically updated with the original manuscript, and there may also be improper translations. Readers are advised to use the English manuscript as a reference for more accurate information.
3. All product information provided on the website refer to solutions from manufacturers' technical support or users the contents may have differences in description, and readers are advised to take the original article as the standard.
4. If you have any questions, please contact us at marketing@iczoom.com and mark the subject with "Datasheets" .



Micro ISO  
1 Form C type



Micro ISO  
1 Form A type

RoHS compliant

### FEATURES

- **Low profile:**  
22.5 mm(L)×15 mm(W)×15.7 mm(H)  
.886 inch(L)×.591 inch(W)×.618 inch(H)
- **Low temperature rise**  
Terminal temperature has been reduced compared with using our conventional product
- **Low sound pressure level**  
Noise level has been reduced approx. 10dB compared with using our conventional product.
- **Wide line-up**  
Micro ISO terminal types and resistor inside type.
- **Plastic sealed type**  
Plastically sealed for automatic cleaning.
- **Compact and high-capacity 20A load switching**  
N.O.: 20A 14V DC, N.C.: 10A 14V DC  
(Max. carrying current: at 85°C 185°F)

### TYPICAL APPLICATIONS

- Headlights
- Magnetic clutches
- Radiator fans
- Blowers
- Fog lamps
- Tail lights
- Heaters
- Defoggers
- Horns
- Condenser fans, etc.

### ORDERING INFORMATION

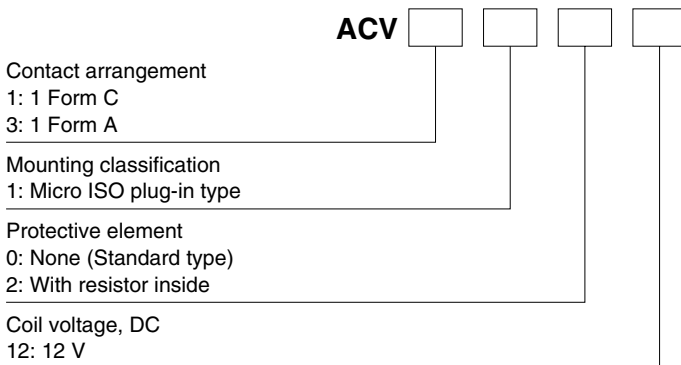

### TYPES

| Contact arrangement | Coil voltage | Protective construction | Mounting classification | Part No. |
|---------------------|--------------|-------------------------|-------------------------|----------|
| 1 Form A            | 12 V DC      | Sealed type             | Micro ISO plug-in type  | ACV31012 |
| 1 Form C            |              |                         | Micro ISO plug-in type  | ACV11012 |

Note: Please use "ACV\*\*212" to order built-in resistor type. (Asterisks " \* " should be filled in from ORDERING INFORMATION.)  
Standard packing: Carton: 50 pcs.; Case: 200 pcs.

### RATING

#### 1. Coil data

| Nominal coil voltage | Pick-up voltage*<br>(at 20°C 68°F) | Drop-out voltage<br>(at 20°C 68°F) | Nominal operating current<br>[±10%] (at 20°C 68°F) | Coil resistance<br>[±10%] (at 20°C 68°F) | Nominal operating power<br>(at 20°C 68°F) | Usable voltage range<br>(at 85°C 185°F) |
|----------------------|------------------------------------|------------------------------------|--|--|---|---|
| 12V DC               | Max. 7.0 V DC<br>(Initial)         | Min. 0.6 V DC<br>(Initial)         | 67 mA,<br>84 mA (with resistor)                    | 180Ω,<br>142.3Ω (with resistor)          | 0.8 W,<br>1.0 W (with resistor)           | 10 to 16V DC                            |

Note: \* Other pick-up voltage types are also available. Please contact us for details.

## 2. Specifications

| Characteristics            | Item  | Specifications  |  |
|----------------------------|---|---|--|
|                            |   | 1 Form A  | 1 Form C   |
| Contact                    | Arrangement                                       | Typ 3mΩ (By voltage drop 6V DC 1A)  |  |
|                            | Contact resistance (Initial)                      | N.O.: Max. 0.2 V (By voltage drop 14 V DC 20 A)<br>N.C.: Max. 0.5 V (By voltage drop 14 V DC 10 A)  |  |
|                            | Contact voltage drop (after electrical life test) | Ag alloy (Cadmium free)   |  |
|                            | Contact material                                  | N.O.: 20 A 14V DC<br>N.C.: 20 A 14V DC, N.C.: 10 A 14V DC   |  |
| Rating                     | Nominal switching capacity (resistive load)       | 0.8 W, 1.0 W (built-in resistor type)   |  |
|                            | Max. carrying current (at 85°C 185°F, continuous) | 1 A 12V DC  |  |
|                            | Nominal operating power                           | N.O.: 20 A 14V DC<br>N.C.: 20 A 14V DC<br>N.C.: 10 A 14V DC   |  |
|                            | Min. switching capacity (resistive load)*1        | N.O.: 20 A 14V DC   |  |
| Electrical characteristics | Insulation resistance (Initial)                   | Min. 20 MΩ (at 500V DC)   |  |
|                            | Breakdown voltage (Initial)                       | Between open contacts   | 500 Vrms for 1 min. (Detection current: 10mA)  |
|                            |   | Between contacts and coil   | 500 Vrms for 1 min. (Detection current: 10mA)  |
|                            | Operate time (at nominal voltage) (at 20°C 68°F)  | Max. 10ms (excluding contact bounce time) (Initial)   |  |
|                            | Release time (at nominal voltage) (at 20°C 68°F)  | Max. 10ms (excluding contact bounce time) (Initial)   |  |
| Mechanical characteristics | Shock resistance                                  | Functional  | Min. 100 m/s <sup>2</sup> {10G} (Half-wave pulse of sine wave: 11ms; detection time: 10μs)                           |
|                            |   | Destructive   | Min. 1,000 m/s <sup>2</sup> {100G} (Half-wave pulse of sine wave: 6ms)   |
|                            | Vibration resistance                              | Functional  | 10 Hz to 100 Hz, Min. 44.1 m/s <sup>2</sup> {4.5G} (Detection time: 10μs)  |
|                            |   | Destructive   | 10 Hz to 500 Hz, Min. 44.1 m/s <sup>2</sup> {4.5G}, Time of vibration for each direction; X, Y, Z direction: 4 hours |
| Expected life              | Mechanical  | Min. 10 <sup>6</sup> (at 120 cpm)   |  |
|                            | Electrical (at nominal switching capacity)        | Min. 10 <sup>5</sup> (operating frequency: 2s ON, 2s OFF)   |  |
| Conditions                 | Conditions for operation, transport and storage*2 | Ambient temperature: -40°C to +85°C -40°F to +185°F*3,<br>Humidity: 5% R.H. to 85% R.H. (Not freezing and condensing at low temperature),<br>air pressure: 86 to 106kPa |  |
| Mass                       |   | Approx. 15 g .53 oz   |  |

Notes: \*1. This value can change due to the switching frequency, environmental conditions, and desired reliability level, therefore it is recommended to check this with the actual load.

\*2. The upper operation ambient temperature limit is the maximum temperature that can satisfy the coil temperature rise value. Please refer to "Usage ambient condition" in CAUTIONS FOR USE OF AUTOMOTIVE RELAYS.

\*3. Please inquire if you will be using the relay in a high temperature atmosphere.

\* Regarding solder, this product is not MIL (Military Standard) compliant. Please evaluate solder mounting by the actual equipment before using.

## REFERENCE DATA

### 1. Coil temperature rise (20A)

Point measured: Inside the coil  
Contact carrying current: 20A  
Coil applied voltage: 13.5V

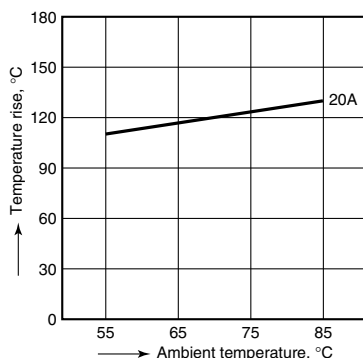

### 2. Distribution of pick-up and drop-out voltage

Sample: ACV11012, 100pcs

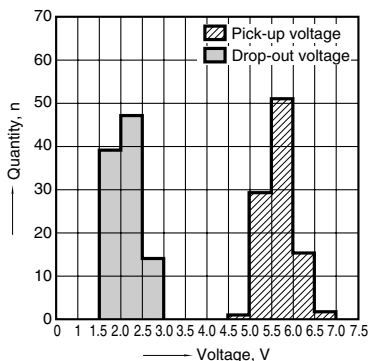

### 3. Distribution of operate and release time

Sample: ACV11012, 100pcs.

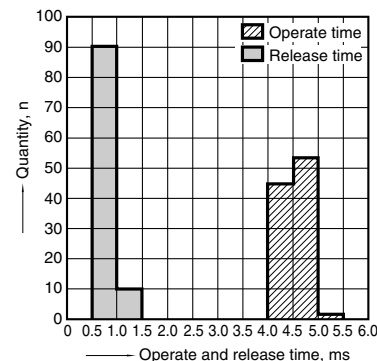

### 4. Ambient temperature and operating voltage range

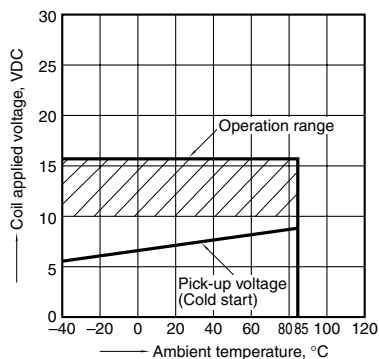

# CV (ACV)

## 5-(1). Electrical life test (Resistive load)

Sample: ACV11012, 3pcs.  
 Load: Resistive load (NC switching) 10A  
 Switching frequency: ON 1s, OFF 1s  
 Ambient temperature: Room temperature

### Circuit

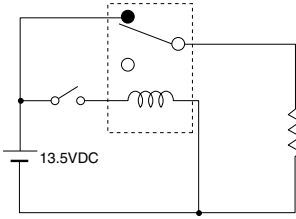

### Change of pick-up and drop-out voltage

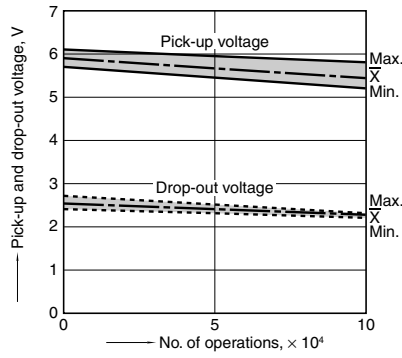

### Change of contact resistance

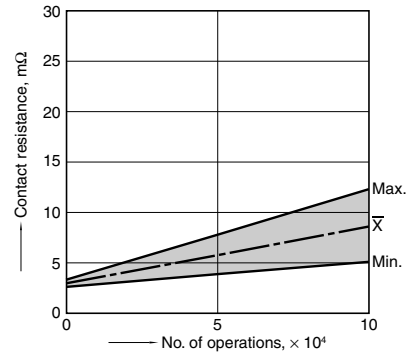

### Load current waveform

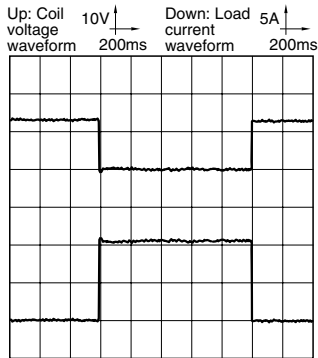

## 5-(2). Electrical life test (Lamp load)

Sample: ACV31212, 3pcs.  
 Load: 55Wx4, inrush: 90A/steady: 20A,  
 lamp actual load  
 Switching frequency: ON 1s, OFF 14s  
 Ambient temperature: Room temperature

### Circuit

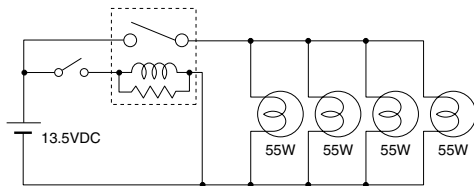

### Change of pick-up and drop-out voltage

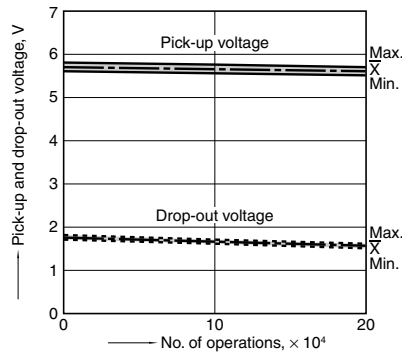

### Change of contact resistance

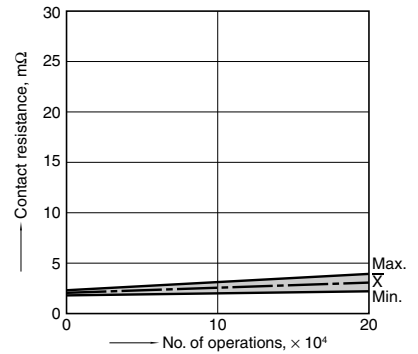

### Load current waveform

Inrush current: 90A, steady current: 20A

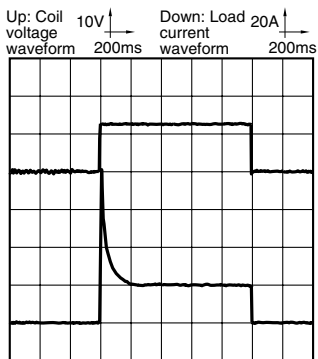

## 5-(3). Electrical life test (Motor load)

Sample: ACV31212, 3pcs.  
 Load: inrush: 80A/steady: 18A,  
 radiator fan actual load (motor free)  
 Switching frequency: ON 2s, OFF 6s  
 Ambient temperature: Room temperature

### Circuit

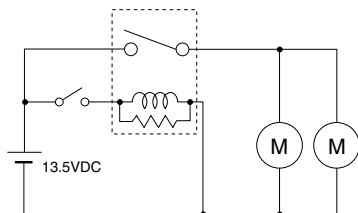

### Change of pick-up and drop-out voltage

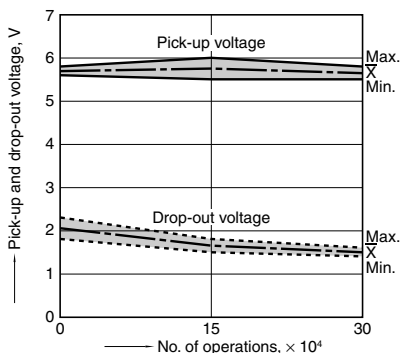

### Change of contact resistance

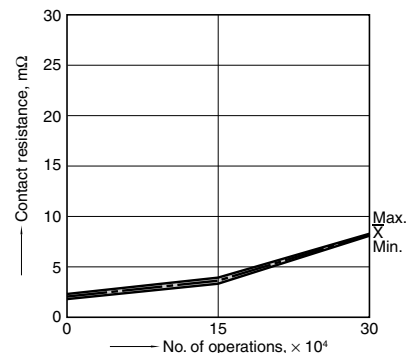

### Load current waveform

Inrush current: 80A, steady current: 18A

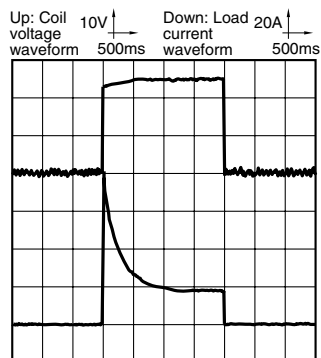

## DIMENSIONS (mm inch)

The CAD data of the products with a **CAD Data** mark can be downloaded from: <http://industrial.panasonic.com/ac/e/>

### 1. Micro ISO plug-in type

**CAD Data**



#### External dimensions

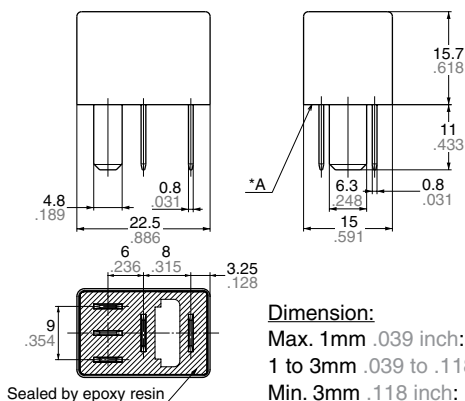

| Dimension: | Tolerance          |
|------------|--------------------|
| Max. 1mm   | $\pm 0.1 \pm 0.04$ |
| 1 to 3mm   | $\pm 0.2 \pm 0.08$ |
| Min. 3mm   | $\pm 0.3 \pm 0.12$ |

#### Schematic (Bottom view)

##### 1 Form A

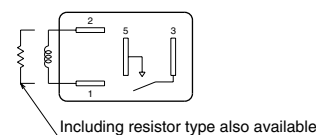

##### 1 Form C

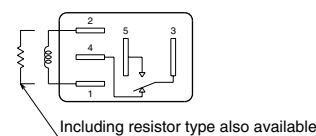

Note: Intervals between terminals is measured at A surface level.

**For Cautions for Use, see Relay Technical Information.**