

阅读申明

- 1.本站收集的数据手册和产品资料都来自互联网，版权归原作者所有。如读者和版权方有任何异议请及时告之，我们将妥善解决。
- 2.本站提供的中文数据手册是英文数据手册的中文翻译，其目的是协助用户阅读，该译文无法自动跟随原稿更新，同时也可能存在翻译上的不当。建议读者以英文原稿为参考以便获得更精准的信息。
- 3.本站提供的产品资料，来自厂商的技术支持或者使用者的心得体会等，其内容可能存在描述上的差异，建议读者做出适当判断。
- 4.如需与我们联系，请发邮件到marketing@iczoom.com，主题请标有“数据手册”字样。

Read Statement

1. The datasheets and other product information on the site are all from network reference or other public materials, and the copyright belongs to the original author and original published source. If readers and copyright owners have any objections, please contact us and we will deal with it in a timely manner.
2. The Chinese datasheets provided on the website is a Chinese translation of the English datasheets. Its purpose is for reader's learning exchange only and do not involve commercial purposes. The translation cannot be automatically updated with the original manuscript, and there may also be improper translations. Readers are advised to use the English manuscript as a reference for more accurate information.
3. All product information provided on the website refer to solutions from manufacturers' technical support or users the contents may have differences in description, and readers are advised to take the original article as the standard.
4. If you have any questions, please contact us at marketing@iczoom.com and mark the subject with "Datasheets" .



Discontinued: Keep type
Last time buy: August 31, 2012



Panasonic

ideas for life

Relay for control panel of
1A to 10A (1c/2c/3c/4c)

HC RELAYS



Standard type



Amber sealed type



With CR circuit type

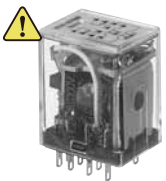

Keep relay



With diode type

FEATURES

1. Standard type, Amber sealed type and **Keep type** ⚠
2. Rich lineup includes relays with operating indication, with diode and with CR circuit
3. Full range of types
Plug-in type, PC board type and TM type
4. Sockets and terminal sockets are available.

TYPICAL APPLICATIONS

1. Factory automation equipment and automotive devices
2. Control panels, power supply equipment, molding equipment, machine tools, welding equipment, agricultural equipment, etc.
3. Office equipment, automatic vending machines, telecommunications equipment, disaster prevention equipment, copiers, measuring devices, medical equipment, amusement devices, etc.
4. All types of household appliance

RoHS compliant

ORDERING INFORMATION

HC - - - - -

Contact arrangement

- 1: 1 Form C
- 2: 2 Form C
- 3: 3 Form C
- 4: 4 Form C
- 4D: Bifurcated contact (twin)

Nil: Standard type

E: Amber sealed type (Only 1 Form C and 2 Form C)

ED: Amber sealed type bifurcated contact (twin) (Only 4 Form C)

⚠ K: Keep type

Terminal arrangement

- H: Plug-in type
- HL: Plug-in with LED indication
- L: Plug-in with LED indication (Amber sealed type)
- HP: PC board type
- PL: PC board with LED indication
- HPL: PC board with LED indication (Amber sealed type)
- HTM: TM type

Nominal coil voltage

AC 6, 12, 24, 48, 100 (100/110), 120 (110/120), 200 (200/220), 240 (220/240) V

DC 6, 12, 24, 48, 100 (100/110) V

Surge suppression

D: With diode R: With CR circuit





Contact material

| Contact arrangement | Contact material | |
|--------------------------|-------------------------|-----------|
| | AgSnO ₂ type | AgNi type |
| 1 Form C | F | |
| 2 Form C | F | |
| 3 Form C | F | |
| 4 Form C | | Nil |
| 4-pole bifurcated (twin) | | Nil |

Notes: Certified by UL and CSA (except for keep type)

Please consult us about VDE (1 Form C, 2 Form C, and 4 Form C only) and TV-3 (1 Form C and 2 Form C only) approved products.

LINEUP

| Type | Contact arrangement | |  | |  | |  | Remarks |
|--|---------------------|----------|---|----------|---|----------|---|----------------------------------|
| | | | Plug-in terminal type | | PC board terminal type | | | |
| | | | Without LED | With LED | Without LED | With LED | | |
| HC relay Standard type | Single side stable | 1 Form C | A | A | A | A | A | |
| | | 2 Form C | A | A | A | A | A | |
| | | 3 Form C | A | A | A | A | A | |
| | | 4 Form C | A | A | A | A | A | |
| | Bifurcated (Twin) | 4 Form C | A | A | A | A | A | |
| HC relay Amber sealed type | Single side stable | 1 Form C | A | A | A | A | A | |
| | | 2 Form C | A | A | A | A | A | |
| | | 4 Form C | A | A | A | A | A | |
| | Bifurcated (Twin) | 4 Form C | A | A | A | A | A | |
|  HC keep (latching) relay | Single side stable | 2 Form C | A (With operating indication) | — | A (With operating indication) | — | — | |
| DC type with surge absorbing diode | Single side stable | 1 Form C | A | A | — | — | — | Amber sealed type also available |
| | | 2 Form C | A | A | — | — | — | |
| | | 3 Form C | A | A | — | — | — | |
| | | 4 Form C | A | A | — | — | — | |
| | Bifurcated (Twin) | 4 Form C | A | A | — | — | — | |
| AC type with surge absorbing CR circuit | Single side stable | 1 Form C | A | A | — | — | — | 17 mm higher than standard type |
| | | 2 Form C | A | A | — | — | — | |
| | | 3 Form C | A | A | — | — | — | |
| | | 4 Form C | A | A | — | — | — | |
| | Bifurcated (Twin) | 4 Form C | A | A | — | — | — | |

A: Available
 Notes: 1. HC relays with ground terminals also available.
 2. HC relays with 0.9 mm wide PC board terminals also available.

HC RELAY CONTACT ARRANGEMENT

| Type | Single side stable contact | 4-pole bifurcated (twin) contact |
|-------------|--|--|
| Part number | HC□ | HC4D |
| Features | Suitable for high-capacity load switching Standard type HC relays have high single-contact capacity; 1 Form C: 10 A 2 Form C and 3 Form C: 7 A 4 Form C: 5 A | Bifurcated (twin) contact ensures high contact reliability Suitable for low level loads Minimum switching capability: 100 μA 100m V DC (reference value) |

LED INDICATION TYPE

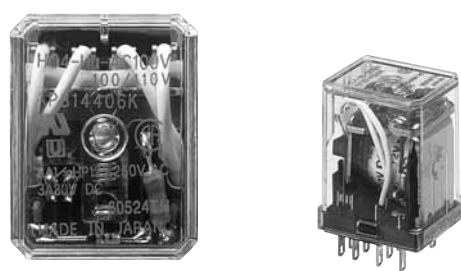
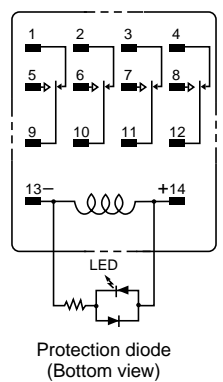
| Type | With LED indication type | |
|-------------|--|--|
| Part number | HC□-HL | |
| Features | LED lights up when relay is operating Inspection and detection of trouble is easy. LEDs are green for DC types and red for AC types. All types are available with LED indication. |  <p>• LED colors indicate the type of relay: red for AC type and green for DC type.</p>  <p>Protection diode (Bottom view)</p> |



Discontinued: Keep type
Last time buy: August 31, 2012

HC

HC RELAY SERIES PRODUCT TYPES

| Type | Amber sealed type HC relay |  HC keep (Latching) relay | HC relay with diode type (for DC) |
|-------------|---|--|--|
| Part number | HC□E | HC2K | HC□-□-□V-D |
| Features | Relay is completely sealed with resin. Provides high reliability in adverse surroundings. Suitable for use in dusty conditions or where organic gases are present | Magnetic latching relay Suitable for nominal operating power saving of operating circuits and for memory circuits Has operating indication (mechanical indicator). | Has built-in diode to absorb surge when the coil goes to the off state (for DC type). Suitable for protecting relay driver circuits and for noise suppression Diode characteristics: Reverse breakdown voltage 1,000 V Forward current 1 A |
| Type | HC relay with CR circuit (for AC) | — | — |
| Part number | HC□-□-□V-R | — | — |
| Features | Has built-in CR circuit to absorb surge when the coil goes to the off state (for AC). Relay with CR circuit is 17 mm higher than standard type relay. | — | — |

4-pole bifurcated (twin) type and Relay with LED indication are available.

TYPES

1. Standard type

1) Plug-in type

| Nominal coil voltage | 1 Form C | 2 Form C | 3 Form C | 4 Form C | 4 Form C (twin) |
|----------------------|----------------|----------------|----------------|--------------|-----------------|
| | Part No. | Part No. | Part No. | Part No. | Part No. |
| 6V AC | HC1-H-AC6V-F | HC2-H-AC6V-F | HC3-H-AC6V-F | HC4-H-AC6V | HC4D-H-AC6V |
| 12V AC | HC1-H-AC12V-F | HC2-H-AC12V-F | HC3-H-AC12V-F | HC4-H-AC12V | HC4D-H-AC12V |
| 24V AC | HC1-H-AC24V-F | HC2-H-AC24V-F | HC3-H-AC24V-F | HC4-H-AC24V | HC4D-H-AC24V |
| 48V AC | HC1-H-AC48V-F | HC2-H-AC48V-F | HC3-H-AC48V-F | HC4-H-AC48V | HC4D-H-AC48V |
| 100/110V AC | HC1-H-AC100V-F | HC2-H-AC100V-F | HC3-H-AC100V-F | HC4-H-AC100V | HC4D-H-AC100V |
| 110/120V AC | HC1-H-AC120V-F | HC2-H-AC120V-F | HC3-H-AC120V-F | HC4-H-AC120V | HC4D-H-AC120V |
| 200/220V AC | HC1-H-AC200V-F | HC2-H-AC200V-F | HC3-H-AC200V-F | HC4-H-AC200V | HC4D-H-AC200V |
| 220/240V AC | HC1-H-AC240V-F | HC2-H-AC240V-F | HC3-H-AC240V-F | HC4-H-AC240V | HC4D-H-AC240V |
| 6V DC | HC1-H-DC6V-F | HC2-H-DC6V-F | HC3-H-DC6V-F | HC4-H-DC6V | HC4D-H-DC6V |
| 12V DC | HC1-H-DC12V-F | HC2-H-DC12V-F | HC3-H-DC12V-F | HC4-H-DC12V | HC4D-H-DC12V |
| 24V DC | HC1-H-DC24V-F | HC2-H-DC24V-F | HC3-H-DC24V-F | HC4-H-DC24V | HC4D-H-DC24V |
| 48V DC | HC1-H-DC48V-F | HC2-H-DC48V-F | HC3-H-DC48V-F | HC4-H-DC48V | HC4D-H-DC48V |
| 100/110V DC | HC1-H-DC100V-F | HC2-H-DC100V-F | HC3-H-DC100V-F | HC4-H-DC100V | HC4D-H-DC100V |

Standard packing: Carton: 20 pcs.; Case: 200 pcs.

2) Plug-in type (with LED indication)

| Nominal coil voltage | 1 Form C | 2 Form C | 3 Form C | 4 Form C | 4 Form C (twin) |
|----------------------|-----------------|-----------------|-----------------|---------------|-----------------|
| | Part No. | Part No. | Part No. | Part No. | Part No. |
| 6V AC | HC1-HL-AC6V-F | HC2-HL-AC6V-F | HC3-HL-AC6V-F | HC4-HL-AC6V | HC4D-HL-AC6V |
| 12V AC | HC1-HL-AC12V-F | HC2-HL-AC12V-F | HC3-HL-AC12V-F | HC4-HL-AC12V | HC4D-HL-AC12V |
| 24V AC | HC1-HL-AC24V-F | HC2-HL-AC24V-F | HC3-HL-AC24V-F | HC4-HL-AC24V | HC4D-HL-AC24V |
| 100/110V AC | HC1-HL-AC100V-F | HC2-HL-AC100V-F | HC3-HL-AC100V-F | HC4-HL-AC100V | HC4D-HL-AC100V |
| 110/120V AC | HC1-HL-AC120V-F | HC2-HL-AC120V-F | HC3-HL-AC120V-F | HC4-HL-AC120V | HC4D-HL-AC120V |
| 200/220V AC | HC1-HL-AC200V-F | HC2-HL-AC200V-F | HC3-HL-AC200V-F | HC4-HL-AC200V | HC4D-HL-AC200V |
| 220/240V AC | HC1-HL-AC240V-F | HC2-HL-AC240V-F | HC3-HL-AC240V-F | HC4-HL-AC240V | HC4D-HL-AC240V |
| 6V DC | HC1-HL-DC6V-F | HC2-HL-DC6V-F | HC3-HL-DC6V-F | HC4-HL-DC6V | HC4D-HL-DC6V |
| 12V DC | HC1-HL-DC12V-F | HC2-HL-DC12V-F | HC3-HL-DC12V-F | HC4-HL-DC12V | HC4D-HL-DC12V |
| 24V DC | HC1-HL-DC24V-F | HC2-HL-DC24V-F | HC3-HL-DC24V-F | HC4-HL-DC24V | HC4D-HL-DC24V |
| 48V DC | HC1-HL-DC48V-F | HC2-HL-DC48V-F | HC3-HL-DC48V-F | HC4-HL-DC48V | HC4D-HL-DC48V |
| 100/110V DC | HC1-HL-DC100V-F | HC2-HL-DC100V-F | HC3-HL-DC100V-F | HC4-HL-DC100V | HC4D-HL-DC100V |

Standard packing: Carton: 20 pcs.; Case: 200 pcs.

3) PC board type

| Nominal coil voltage | 1 Form C | 2 Form C | 3 Form C | 4 Form C | 4 Form C (twin) |
|----------------------|-----------------|-----------------|-----------------|---------------|-----------------|
| | Part No. | Part No. | Part No. | Part No. | Part No. |
| 6V AC | HC1-HP-AC6V-F | HC2-HP-AC6V-F | HC3-HP-AC6V-F | HC4-HP-AC6V | HC4D-HP-AC6V |
| 12V AC | HC1-HP-AC12V-F | HC2-HP-AC12V-F | HC3-HP-AC12V-F | HC4-HP-AC12V | HC4D-HP-AC12V |
| 24V AC | HC1-HP-AC24V-F | HC2-HP-AC24V-F | HC3-HP-AC24V-F | HC4-HP-AC24V | HC4D-HP-AC24V |
| 48V AC | HC1-HP-AC48V-F | HC2-HP-AC48V-F | HC3-HP-AC48V-F | HC4-HP-AC48V | HC4D-HP-AC48V |
| 100/110V AC | HC1-HP-AC100V-F | HC2-HP-AC100V-F | HC3-HP-AC100V-F | HC4-HP-AC100V | HC4D-HP-AC100V |
| 110/120V AC | HC1-HP-AC120V-F | HC2-HP-AC120V-F | HC3-HP-AC120V-F | HC4-HP-AC120V | HC4D-HP-AC120V |
| 200/220V AC | HC1-HP-AC200V-F | HC2-HP-AC200V-F | HC3-HP-AC200V-F | HC4-HP-AC200V | HC4D-HP-AC200V |
| 220/240V AC | HC1-HP-AC240V-F | HC2-HP-AC240V-F | HC3-HP-AC240V-F | HC4-HP-AC240V | HC4D-HP-AC240V |
| 6V DC | HC1-HP-DC6V-F | HC2-HP-DC6V-F | HC3-HP-DC6V-F | HC4-HP-DC6V | HC4D-HP-DC6V |
| 12V DC | HC1-HP-DC12V-F | HC2-HP-DC12V-F | HC3-HP-DC12V-F | HC4-HP-DC12V | HC4D-HP-DC12V |
| 24V DC | HC1-HP-DC24V-F | HC2-HP-DC24V-F | HC3-HP-DC24V-F | HC4-HP-DC24V | HC4D-HP-DC24V |
| 48V DC | HC1-HP-DC48V-F | HC2-HP-DC48V-F | HC3-HP-DC48V-F | HC4-HP-DC48V | HC4D-HP-DC48V |
| 100/110V DC | HC1-HP-DC100V-F | HC2-HP-DC100V-F | HC3-HP-DC100V-F | HC4-HP-DC100V | HC4D-HP-DC100V |

Standard packing: Carton: 20 pcs.; Case: 200 pcs.

Note: Please add "-31" before "-F" in the part number when ordering the PC board type 0.9 mm width terminal (ex) HC1-HP-AC6V-31-F.

4) PC board type (with LED indication)

| Nominal coil voltage | 1 Form C | 2 Form C | 3 Form C | 4 Form C | 4 Form C (twin) |
|----------------------|------------------|------------------|------------------|----------------|-----------------|
| | Part No. | Part No. | Part No. | Part No. | Part No. |
| 6V AC | HC1-HPL-AC6V-F | HC2-HPL-AC6V-F | HC3-HPL-AC6V-F | HC4-HPL-AC6V | HC4D-HPL-AC6V |
| 12V AC | HC1-HPL-AC12V-F | HC2-HPL-AC12V-F | HC3-HPL-AC12V-F | HC4-HPL-AC12V | HC4D-HPL-AC12V |
| 24V AC | HC1-HPL-AC24V-F | HC2-HPL-AC24V-F | HC3-HPL-AC24V-F | HC4-HPL-AC24V | HC4D-HPL-AC24V |
| 100/110V AC | HC1-HPL-AC100V-F | HC2-HPL-AC100V-F | HC3-HPL-AC100V-F | HC4-HPL-AC100V | HC4D-HPL-AC100V |
| 110/120V AC | HC1-HPL-AC120V-F | HC2-HPL-AC120V-F | HC3-HPL-AC120V-F | HC4-HPL-AC120V | HC4D-HPL-AC120V |
| 200/220V AC | HC1-HPL-AC200V-F | HC2-HPL-AC200V-F | HC3-HPL-AC200V-F | HC4-HPL-AC200V | HC4D-HPL-AC200V |
| 6V DC | HC1-HPL-DC6V-F | HC2-HPL-DC6V-F | HC3-HPL-DC6V-F | HC4-HPL-DC6V | HC4D-HPL-DC6V |
| 12V DC | HC1-HPL-DC12V-F | HC2-HPL-DC12V-F | HC3-HPL-DC12V-F | HC4-HPL-DC12V | HC4D-HPL-DC12V |
| 24V DC | HC1-HPL-DC24V-F | HC2-HPL-DC24V-F | HC3-HPL-DC24V-F | HC4-HPL-DC24V | HC4D-HPL-DC24V |
| 48V DC | HC1-HPL-DC48V-F | HC2-HPL-DC48V-F | HC3-HPL-DC48V-F | HC4-HPL-DC48V | HC4D-HPL-DC48V |
| 100/110V DC | HC1-HPL-DC100V-F | HC2-HPL-DC100V-F | HC3-HPL-DC100V-F | HC4-HPL-DC100V | HC4D-HPL-DC100V |

Standard packing: Carton: 20 pcs.; Case: 200 pcs.

Note: Please add "-31" before "-F" in the part number when ordering the PC board type 0.9 mm width terminal (ex) HC1-HPL-AC6V-31-F.

5) TM type

| Nominal coil voltage | 1 Form C | 2 Form C | 3 Form C | 4 Form C | 4 Form C (twin) |
|----------------------|------------------|------------------|------------------|----------------|-----------------|
| | Part No. | Part No. | Part No. | Part No. | Part No. |
| 6V AC | HC1-HTM-AC6V-F | HC2-HTM-AC6V-F | HC3-HTM-AC6V-F | HC4-HTM-AC6V | HC4D-HTM-AC6V |
| 12V AC | HC1-HTM-AC12V-F | HC2-HTM-AC12V-F | HC3-HTM-AC12V-F | HC4-HTM-AC12V | HC4D-HTM-AC12V |
| 24V AC | HC1-HTM-AC24V-F | HC2-HTM-AC24V-F | HC3-HTM-AC24V-F | HC4-HTM-AC24V | HC4D-HTM-AC24V |
| 48V AC | HC1-HTM-AC48V-F | HC2-HTM-AC48V-F | HC3-HTM-AC48V-F | HC4-HTM-AC48V | HC4D-HTM-AC48V |
| 100/110V AC | HC1-HTM-AC100V-F | HC2-HTM-AC100V-F | HC3-HTM-AC100V-F | HC4-HTM-AC100V | HC4D-HTM-AC100V |
| 110/120V AC | HC1-HTM-AC120V-F | HC2-HTM-AC120V-F | HC3-HTM-AC120V-F | HC4-HTM-AC120V | HC4D-HTM-AC120V |
| 200/220V AC | HC1-HTM-AC200V-F | HC2-HTM-AC200V-F | HC3-HTM-AC200V-F | HC4-HTM-AC200V | HC4D-HTM-AC200V |
| 6V DC | HC1-HTM-DC6V-F | HC2-HTM-DC6V-F | HC3-HTM-DC6V-F | HC4-HTM-DC6V | HC4D-HTM-DC6V |
| 12V DC | HC1-HTM-DC12V-F | HC2-HTM-DC12V-F | HC3-HTM-DC12V-F | HC4-HTM-DC12V | HC4D-HTM-DC12V |
| 24V DC | HC1-HTM-DC24V-F | HC2-HTM-DC24V-F | HC3-HTM-DC24V-F | HC4-HTM-DC24V | HC4D-HTM-DC24V |
| 48V DC | HC1-HTM-DC48V-F | HC2-HTM-DC48V-F | HC3-HTM-DC48V-F | HC4-HTM-DC48V | HC4D-HTM-DC48V |
| 100/110V DC | HC1-HTM-DC100V-F | HC2-HTM-DC100V-F | HC3-HTM-DC100V-F | HC4-HTM-DC100V | HC4D-HTM-DC100V |

Standard packing: Carton: 20 pcs.; Case: 200 pcs.



Discontinued: Keep type
Last time buy: August 31, 2012

HC

2. Amber sealed type

1) Plug-in type

| Nominal coil voltage | 1 Form C | 2 Form C | 4 Form C | 4 Form C (twin) |
|----------------------|-----------------|-----------------|---------------|-----------------|
| | Part No. | Part No. | Part No. | Part No. |
| 6V AC | HC1E-H-AC6V-F | HC2E-H-AC6V-F | HC4E-H-AC6V | HC4ED-H-AC6V |
| 12V AC | HC1E-H-AC12V-F | HC2E-H-AC12V-F | HC4E-H-AC12V | HC4ED-H-AC12V |
| 24V AC | HC1E-H-AC24V-F | HC2E-H-AC24V-F | HC4E-H-AC24V | HC4ED-H-AC24V |
| 48V AC | HC1E-H-AC48V-F | HC2E-H-AC48V-F | HC4E-H-AC48V | HC4ED-H-AC48V |
| 100/110V AC | HC1E-H-AC100V-F | HC2E-H-AC100V-F | HC4E-H-AC100V | HC4ED-H-AC100V |
| 110/120V AC | HC1E-H-AC120V-F | HC2E-H-AC120V-F | HC4E-H-AC120V | HC4ED-H-AC120V |
| 200/220V AC | HC1E-H-AC200V-F | HC2E-H-AC200V-F | HC4E-H-AC200V | HC4ED-H-AC200V |
| 220/240V AC | HC1E-H-AC240V-F | HC2E-H-AC240V-F | HC4E-H-AC240V | HC4ED-H-AC240V |
| 6V DC | HC1E-H-DC6V-F | HC2E-H-DC6V-F | HC4E-H-DC6V | HC4ED-H-DC6V |
| 12V DC | HC1E-H-DC12V-F | HC2E-H-DC12V-F | HC4E-H-DC12V | HC4ED-H-DC12V |
| 24V DC | HC1E-H-DC24V-F | HC2E-H-DC24V-F | HC4E-H-DC24V | HC4ED-H-DC24V |
| 48V DC | HC1E-H-DC48V-F | HC2E-H-DC48V-F | HC4E-H-DC48V | HC4ED-H-DC48V |
| 100/110V DC | HC1E-H-DC100V-F | HC2E-H-DC100V-F | HC4E-H-DC100V | HC4ED-H-DC100V |

Standard packing: Carton: 20 pcs.; Case: 200 pcs.

2) Plug-in type (With LED indication)

| Nominal coil voltage | 1 Form C | 2 Form C | 4 Form C | 4 Form C (twin) |
|----------------------|-----------------|-----------------|---------------|-----------------|
| | Part No. | Part No. | Part No. | Part No. |
| 6V AC | HC1E-L-AC6V-F | HC2E-L-AC6V-F | HC4E-L-AC6V | HC4ED-L-AC6V |
| 12V AC | HC1E-L-AC12V-F | HC2E-L-AC12V-F | HC4E-L-AC12V | HC4ED-L-AC12V |
| 24V AC | HC1E-L-AC24V-F | HC2E-L-AC24V-F | HC4E-L-AC24V | HC4ED-L-AC24V |
| 48V AC | HC1E-L-AC48V-F | HC2E-L-AC48V-F | HC4E-L-AC48V | HC4ED-L-AC48V |
| 100/110V AC | HC1E-L-AC100V-F | HC2E-L-AC100V-F | HC4E-L-AC100V | HC4ED-L-AC100V |
| 110/120V AC | HC1E-L-AC120V-F | HC2E-L-AC120V-F | HC4E-L-AC120V | HC4ED-L-AC120V |
| 200/220V AC | HC1E-L-AC200V-F | HC2E-L-AC200V-F | HC4E-L-AC200V | HC4ED-L-AC200V |
| 220/240V AC | HC1E-L-AC240V-F | HC2E-L-AC240V-F | HC4E-L-AC240V | HC4ED-L-AC240V |
| 6V DC | HC1E-L-DC6V-F | HC2E-L-DC6V-F | HC4E-L-DC6V | HC4ED-L-DC6V |
| 12V DC | HC1E-L-DC12V-F | HC2E-L-DC12V-F | HC4E-L-DC12V | HC4ED-L-DC12V |
| 24V DC | HC1E-L-DC24V-F | HC2E-L-DC24V-F | HC4E-L-DC24V | HC4ED-L-DC24V |
| 48V DC | HC1E-L-DC48V-F | HC2E-L-DC48V-F | HC4E-L-DC48V | HC4ED-L-DC48V |
| 100/110V DC | HC1E-L-DC100V-F | HC2E-L-DC100V-F | HC4E-L-DC100V | HC4ED-L-DC100V |

Standard packing: Carton: 20 pcs.; Case: 200 pcs.

3) PC board type

| Nominal coil voltage | 1 Form C | 2 Form C | 4 Form C | 4 Form C (twin) |
|----------------------|------------------|------------------|----------------|-----------------|
| | Part No. | Part No. | Part No. | Part No. |
| 6V AC | HC1E-HP-AC6V-F | HC2E-HP-AC6V-F | HC4E-HP-AC6V | HC4ED-HP-AC6V |
| 12V AC | HC1E-HP-AC12V-F | HC2E-HP-AC12V-F | HC4E-HP-AC12V | HC4ED-HP-AC12V |
| 24V AC | HC1E-HP-AC24V-F | HC2E-HP-AC24V-F | HC4E-HP-AC24V | HC4ED-HP-AC24V |
| 48V AC | HC1E-HP-AC48V-F | HC2E-HP-AC48V-F | HC4E-HP-AC48V | HC4ED-HP-AC48V |
| 100/110V AC | HC1E-HP-AC100V-F | HC2E-HP-AC100V-F | HC4E-HP-AC100V | HC4ED-HP-AC100V |
| 110/120V AC | HC1E-HP-AC120V-F | HC2E-HP-AC120V-F | HC4E-HP-AC120V | HC4ED-HP-AC120V |
| 200/220V AC | HC1E-HP-AC200V-F | HC2E-HP-AC200V-F | HC4E-HP-AC200V | HC4ED-HP-AC200V |
| 220/240V AC | HC1E-HP-AC240V-F | HC2E-HP-AC240V-F | HC4E-HP-AC240V | HC4ED-HP-AC240V |
| 6V DC | HC1E-HP-DC6V-F | HC2E-HP-DC6V-F | HC4E-HP-DC6V | HC4ED-HP-DC6V |
| 12V DC | HC1E-HP-DC12V-F | HC2E-HP-DC12V-F | HC4E-HP-DC12V | HC4ED-HP-DC12V |
| 24V DC | HC1E-HP-DC24V-F | HC2E-HP-DC24V-F | HC4E-HP-DC24V | HC4ED-HP-DC24V |
| 48V DC | HC1E-HP-DC48V-F | HC2E-HP-DC48V-F | HC4E-HP-DC48V | HC4ED-HP-DC48V |
| 100/110V DC | HC1E-HP-DC100V-F | HC2E-HP-DC100V-F | HC4E-HP-DC100V | HC4ED-HP-DC100V |

Standard packing: Carton: 20 pcs.; Case: 200 pcs.

Note: Please add "-31" in the suffix of part number when ordering the PC board type 0.9 mm width terminal. (4 Form C, 4 Form C (twin) only)

4) PC board type (With LED indication)

| Nominal coil voltage | 1 Form C | 2 Form C | 4 Form C | 4 Form C (twin) |
|----------------------|------------------|------------------|----------------|-----------------|
| | Part No. | Part No. | Part No. | Part No. |
| 6V AC | HC1E-PL-AC6V-F | HC2E-PL-AC6V-F | HC4E-PL-AC6V | HC4ED-PL-AC6V |
| 12V AC | HC1E-PL-AC12V-F | HC2E-PL-AC12V-F | HC4E-PL-AC12V | HC4ED-PL-AC12V |
| 24V AC | HC1E-PL-AC24V-F | HC2E-PL-AC24V-F | HC4E-PL-AC24V | HC4ED-PL-AC24V |
| 48V AC | HC1E-PL-AC48V-F | HC2E-PL-AC48V-F | HC4E-PL-AC48V | HC4ED-PL-AC48V |
| 100/110V AC | HC1E-PL-AC100V-F | HC2E-PL-AC100V-F | HC4E-PL-AC100V | HC4ED-PL-AC100V |
| 110/120V AC | HC1E-PL-AC120V-F | HC2E-PL-AC120V-F | HC4E-PL-AC120V | HC4ED-PL-AC120V |
| 200/220V AC | HC1E-PL-AC200V-F | HC2E-PL-AC200V-F | HC4E-PL-AC200V | HC4ED-PL-AC200V |
| 220/240V AC | HC1E-PL-AC240V-F | HC2E-PL-AC240V-F | HC4E-PL-AC240V | HC4ED-PL-AC240V |
| 6V DC | HC1E-PL-DC6V-F | HC2E-PL-DC6V-F | HC4E-PL-DC6V | HC4ED-PL-DC6V |
| 12V DC | HC1E-PL-DC12V-F | HC2E-PL-DC12V-F | HC4E-PL-DC12V | HC4ED-PL-DC12V |
| 24V DC | HC1E-PL-DC24V-F | HC2E-PL-DC24V-F | HC4E-PL-DC24V | HC4ED-PL-DC24V |
| 48V DC | HC1E-PL-DC48V-F | HC2E-PL-DC48V-F | HC4E-PL-DC48V | HC4ED-PL-DC48V |
| 100/110V DC | HC1E-PL-DC100V-F | HC2E-PL-DC100V-F | HC4E-PL-DC100V | HC4ED-PL-DC100V |

Standard packing: Carton: 20 pcs.; Case: 200 pcs.

Note: Please add "-31" in the suffix of part number when ordering the PC board type 0.9 mm width terminal. (4 Form C, 4 Form C (twin) only)

5) TM type

| Nominal coil voltage | 1 Form C | 2 Form C | 4 Form C | 4 Form C (twin) |
|----------------------|-------------------|-------------------|-----------------|------------------|
| | Part No. | Part No. | Part No. | Part No. |
| 6V AC | HC1E-HTM-AC6V-F | HC2E-HTM-AC6V-F | HC4E-HTM-AC6V | HC4ED-HTM-AC6V |
| 12V AC | HC1E-HTM-AC12V-F | HC2E-HTM-AC12V-F | HC4E-HTM-AC12V | HC4ED-HTM-AC12V |
| 24V AC | HC1E-HTM-AC24V-F | HC2E-HTM-AC24V-F | HC4E-HTM-AC24V | HC4ED-HTM-AC24V |
| 48V AC | HC1E-HTM-AC48V-F | HC2E-HTM-AC48V-F | HC4E-HTM-AC48V | HC4ED-HTM-AC48V |
| 100/110V AC | HC1E-HTM-AC100V-F | HC2E-HTM-AC100V-F | HC4E-HTM-AC100V | HC4ED-HTM-AC100V |
| 110/120V AC | HC1E-HTM-AC120V-F | HC2E-HTM-AC120V-F | HC4E-HTM-AC120V | HC4ED-HTM-AC120V |
| 200/220V AC | HC1E-HTM-AC200V-F | HC2E-HTM-AC200V-F | HC4E-HTM-AC200V | HC4ED-HTM-AC200V |
| 220/240V AC | HC1E-HTM-AC240V-F | HC2E-HTM-AC240V-F | HC4E-HTM-AC240V | HC4ED-HTM-AC240V |
| 6V DC | HC1E-HTM-DC6V-F | HC2E-HTM-DC6V-F | HC4E-HTM-DC6V | HC4ED-HTM-DC6V |
| 12V DC | HC1E-HTM-DC12V-F | HC2E-HTM-DC12V-F | HC4E-HTM-DC12V | HC4ED-HTM-DC12V |
| 24V DC | HC1E-HTM-DC24V-F | HC2E-HTM-DC24V-F | HC4E-HTM-DC24V | HC4ED-HTM-DC24V |
| 48V DC | HC1E-HTM-DC48V-F | HC2E-HTM-DC48V-F | HC4E-HTM-DC48V | HC4ED-HTM-DC48V |
| 100/110V DC | HC1E-HTM-DC100V-F | HC2E-HTM-DC100V-F | HC4E-HTM-DC100V | HC4ED-HTM-DC100V |

Standard packing: Carton: 20 pcs.; Case: 200 pcs.

3. Keep relay

| Nominal coil voltage | Plug-in type (2c) | PC board type (2c) |
|----------------------|-------------------|--------------------|
| | Part No. | Part No. |
| 6V AC | HC2K-AC6V-F | HC2K-P-AC6V-F |
| 12V AC | HC2K-AC12V-F | HC2K-P-AC12V-F |
| 24V AC | HC2K-AC24V-F | HC2K-P-AC24V-F |
| 48V AC | HC2K-AC48V-F | HC2K-P-AC48V-F |
| 100V AC | HC2K-AC100V-F | HC2K-P-AC100V-F |
| 6V DC | HC2K-DC6V-F | HC2K-P-DC6V-F |
| 12V DC | HC2K-DC12V-F | HC2K-P-DC12V-F |
| 24V DC | HC2K-DC24V-F | HC2K-P-DC24V-F |
| 48V DC | HC2K-DC48V-F | HC2K-P-DC48V-F |
| 100/110V DC | HC2K-DC100V-F | HC2K-P-DC100V-F |

Standard packing: Carton: 20 pcs.; Case: 200 pcs.

Note: Please refer to the "Standards Chart" for product certification.



Discontinued: Keep type
Last time buy: August 31, 2012

HC

4. With diode type (For DC)

1) Plug-in type

| Nominal coil voltage | 1 Form C | 2 Form C | 3 Form C | 4 Form C | 4 Form C (twin) |
|----------------------|----------------|----------------|----------------|--------------|-----------------|
| | Part No. | Part No. | Part No. | Part No. | Part No. |
| 6V DC | HC1-DC6V-D-F | HC2-DC6V-D-F | HC3-DC6V-D-F | HC4-DC6V-D | HC4D-DC6V-D |
| 12V DC | HC1-DC12V-D-F | HC2-DC12V-D-F | HC3-DC12V-D-F | HC4-DC12V-D | HC4D-DC12V-D |
| 24V DC | HC1-DC24V-D-F | HC2-DC24V-D-F | HC3-DC24V-D-F | HC4-DC24V-D | HC4D-DC24V-D |
| 48V DC | HC1-DC48V-D-F | HC2-DC48V-D-F | HC3-DC48V-D-F | HC4-DC48V-D | HC4D-DC48V-D |
| 100/110V DC | HC1-DC100V-D-F | HC2-DC100V-D-F | HC3-DC100V-D-F | HC4-DC100V-D | HC4D-DC100V-D |

Standard packing: Carton: 20 pcs.; Case: 200 pcs.

2) Plug-in type (with LED indication)

| Nominal coil voltage | 1 Form C | 2 Form C | 3 Form C | 4 Form C | 4 Form C (twin) |
|----------------------|------------------|------------------|------------------|----------------|-----------------|
| | Part No. | Part No. | Part No. | Part No. | Part No. |
| 6V DC | HC1-L-DC6V-D-F | HC2-L-DC6V-D-F | HC3-L-DC6V-D-F | HC4-L-DC6V-D | HC4D-L-DC6V-D |
| 12V DC | HC1-L-DC12V-D-F | HC2-L-DC12V-D-F | HC3-L-DC12V-D-F | HC4-L-DC12V-D | HC4D-L-DC12V-D |
| 24V DC | HC1-L-DC24V-D-F | HC2-L-DC24V-D-F | HC3-L-DC24V-D-F | HC4-L-DC24V-D | HC4D-L-DC24V-D |
| 48V DC | HC1-L-DC48V-D-F | HC2-L-DC48V-D-F | HC3-L-DC48V-D-F | HC4-L-DC48V-D | HC4D-L-DC48V-D |
| 100/110V DC | HC1-L-DC100V-D-F | HC2-L-DC100V-D-F | HC3-L-DC100V-D-F | HC4-L-DC100V-D | HC4D-L-DC100V-D |

Standard packing: Carton: 20 pcs.; Case: 200 pcs.

5. With CR circuit type

1) Plug-in type

| Nominal coil voltage | 1 Form C | 2 Form C | 3 Form C | 4 Form C | 4 Form C (twin) |
|----------------------|----------------|----------------|----------------|--------------|-----------------|
| | Part No. | Part No. | Part No. | Part No. | Part No. |
| 100/110V AC | HC1-AC100V-R-F | HC2-AC100V-R-F | HC3-AC100V-R-F | HC4-AC100V-R | HC4D-AC100V-R |
| 110/120V AC | HC1-AC120V-R-F | HC2-AC120V-R-F | HC3-AC120V-R-F | HC4-AC120V-R | HC4D-AC120V-R |
| 200/220V AC | HC1-AC200V-R-F | HC2-AC200V-R-F | HC3-AC200V-R-F | HC4-AC200V-R | HC4D-AC200V-R |
| 220/240V AC | HC1-AC240V-R-F | HC2-AC240V-R-F | HC3-AC240V-R-F | HC4-AC240V-R | HC4D-AC240V-R |

Standard packing: Carton: 20 pcs.; Case: 200 pcs.

2) Plug-in type (with LED indication)

| Nominal coil voltage | 1 Form C | 2 Form C | 3 Form C | 4 Form C | 4 Form C (twin) |
|----------------------|------------------|------------------|------------------|----------------|-----------------|
| | Part No. | Part No. | Part No. | Part No. | Part No. |
| 100/110V AC | HC1-L-AC100V-R-F | HC2-L-AC100V-R-F | HC3-L-AC100V-R-F | HC4-L-AC100V-R | HC4D-L-AC100V-R |
| 110/120V AC | HC1-L-AC120V-R-F | HC2-L-AC120V-R-F | HC3-L-AC120V-R-F | HC4-L-AC120V-R | HC4D-L-AC120V-R |
| 200/220V AC | HC1-L-AC200V-R-F | HC2-L-AC200V-R-F | HC3-L-AC200V-R-F | HC4-L-AC200V-R | HC4D-L-AC200V-R |
| 220/240V AC | HC1-L-AC240V-R-F | HC2-L-AC240V-R-F | HC3-L-AC240V-R-F | HC4-L-AC240V-R | HC4D-L-AC240V-R |

Standard packing: Carton: 20 pcs.; Case: 200 pcs.

* For sockets and terminal sockets, see page 87.

RATING

1. Standard type

1) Coil data

(1) AC coils (50/60Hz)

| Type | Nominal coil voltage | Pick-up voltage (at 20°C 68°F) | Drop-out voltage (at 20°C 68°F) | Nominal coil current [±20%] (at 20°C 68°F) | | Coil inductance | | Nominal operating power | | Max. applied voltage (at 70°C 158°F) |
|-------------|----------------------|---|---|--|-------------|-----------------|----------------|-------------------------|-------|--------------------------------------|
| | | | | 50Hz | 60Hz | N.C. condition | N.O. condition | 50Hz | 60Hz | |
| Standard | 6V AC | 80%V or less of nominal voltage (Initial) | 30%V or more of nominal voltage (Initial) | 224mA | 200mA | 0.078H | 0.074H | 1.3VA | 1.2VA | 110%V of nominal voltage |
| | 12V AC | | | 111mA | 100mA | 0.312H | 0.295H | | | |
| | 24V AC | | | 56mA | 50mA | 1.243H | 1.181H | | | |
| | 48V AC | | | 28mA | 25mA | 4.974H | 4.145H | | | |
| | 100/110V AC | | | 13.4/14.7mA | 12/13.2mA | 23.75H | 20.63H | | | |
| | 110/120V AC | | | 12.2/13.5mA | 10.9/11.9mA | 27.19H | 25.57H | | | |
| 200/220V AC | 6.7/7.4mA | 6/6.6mA | 85.98H | 81.76H | | | | | | |

Notes: 1. The relay operates in a range of 80% to 110% V of the voltage rating, but ideally, in consideration of temporary voltage fluctuations, it should be operated at the rated voltage. In particular, for AC operation, if the applied voltage drops to 80% V or more below the rated voltage, humming will occur and a large current will flow leading possibly to coil burnout.

2. The maximum applied voltage is the maximum voltage fluctuation value for the coil power supply. This value is not a permissible value for continuous operation. (This value differs depending on the ambient temperature. Please contact us for details.)

(2) DC coils

| Type | Nominal coil voltage | Pick-up voltage (at 20°C 68°F) | Drop-out voltage (at 20°C 68°F) | Nominal coil current [±10%] (at 20°C 68°F) | Coil resistance [±10%] (at 20°C 68°F) | Nominal operating power | Max. applied voltage (at 70°C 158°F) |
|----------|----------------------|---|---|--|---------------------------------------|-------------------------|--------------------------------------|
| Standard | 6V DC | 80%V or less of nominal voltage (Initial) | 10%V or more of nominal voltage (Initial) | 150mA | 40Ω | 0.9W | 110%V of nominal voltage |
| | 12V DC | | | 75mA | 160Ω | | |
| | 24V DC | | | 37mA | 650Ω | | |
| | 48V DC | | | 18.5mA | 2,600Ω | 1.0W | |
| | 100/110V DC | | | 10/11mA | 10,000Ω | | |

- Notes: 1. The coil resistance for DC operation is the value measured when the coil temperature is 20°C 68°F. Compensate ±0.4% for every ±1°C change in temperature.
 2. The relay operates in a range of 80% to 110% V of the voltage rating, but ideally, in consideration of temporary voltage fluctuations, it should be operated at the rated voltage.
 3. For use with 200 V DC, connect a 10 KΩ (5W) resistor, in series, to the 100 V DC relay.
 4. The maximum applied voltage is the maximum voltage fluctuation value for the coil power supply. This value is not a permissible value for continuous operation. (This value differs depending on the ambient temperature. Please contact us for details.)

2) Specifications

| Characteristics | Item | Specifications | | | | |
|-------------------------------|--|--|--|--|--|--|
| | | 1 Form C | 2 Form C | 3 Form C | 4 Form C | 4 Form C (twin) |
| Contact | Arrangement | | | | | |
| | Contact resistance (Initial) | Max. 30 mΩ (By voltage drop 6 V DC 1A) | | | | |
| | Contact material | Ag alloy (cd free) + Au flash | | | AgNi type + Au clad | |
| Rating | Nominal switching capacity (resistive load) | 10A 250V AC | 7A 250V AC | 7A 250V AC | 5A 250V AC | 3A 250V AC |
| | Max. switching power (resistive load) | 2,500VA | 1,750VA | 1,750VA | 1,250VA | 750VA |
| | Max. switching voltage | 250VAC | | | | |
| | Max. switching current | 10A | 7A | 7A | 5A | 3A |
| | Nominal operating power | AC (50Hz): 1.3VA, AC (60Hz): 1.2VA, DC: 0.9 to 1.1W | | | | |
| | Min. switching capacity (Reference value)*1 | 1mA 1V DC | | | | 100μA 1V DC |
| Electrical characteristics | Insulation resistance (Initial) | Min. 1,000MΩ (at 500V DC) Measurement at same location as "Breakdown voltage" section. | | | | |
| | Breakdown voltage (Initial) | Between open contacts | 700 Vrms for 1min. (Detection current: 10mA.) | | | |
| | | Between contact sets | 700 Vrms for 1min. (Detection current: 10mA.) | | | |
| | | Between contact and coil | 2,000 Vrms for 1min. (Detection current: 10mA.) | | | |
| | Temperature rise (coil) (at 70°C 158°F) | Max. 80°C 176°F (By resistive method, nominal coil voltage) | | | | |
| | Operate time (at 20°C 68°F)*2 | Max. 20ms (Nominal coil voltage applied to the coil, excluding contact bounce time.) | | | | |
| Release time (at 20°C 68°F)*2 | Max. 20ms (Nominal coil voltage applied to the coil, excluding contact bounce time.) (without diode) | | | | | |
| Mechanical characteristics | Shock resistance | Functional | Min. 196 m/s ² (Half-wave pulse of sine wave: 11 ms; detection time: 10μs.) | | | |
| | | Destructive | Min. 980 m/s ² (Half-wave pulse of sine wave: 6 ms.) | | | |
| | Vibration resistance | Functional | 10 to 55 Hz at double amplitude of 1 mm (Detection time: 10μs.) | | | |
| | | Destructive | 10 to 55 Hz at double amplitude of 2 mm | | | |
| Expected life | Mechanical | Min. 5×10 ⁷ : AC coil type (at 180 times/min.); Min. 10 ⁸ : DC coil type (at 180 times/min.) | | | | |
| | Electrical | Min. 2×10 ⁵ resistive load (at 20 times/min.) | Min. 2×10 ⁵ resistive load (at 20 times/min.) | Min. 10 ⁵ resistive load (at 20 times/min.) | Min. 2×10 ⁵ resistive load (at 20 times/min.) | Min. 2×10 ⁵ resistive load (at 20 times/min.) |
| Conditions | Conditions for operation, transport and storage*3 | Ambient temperature: -50°C to +70°C -58°F to +158°F (without LED); -50°C to +60°C -58°F to +140°F (with LED) Humidity: 5 to 85% R.H. (Not freezing and condensing at low temperature) | | | | |
| | Max. Operating speed | 20 times/min. (at max. rating) | | | | |
| Unit weight | | Approx. 30g 1.06 oz | | | | |

Notes: *1. This value can change due to the switching frequency, environmental conditions and desired reliability level, therefore it is recommended to check this with the actual load.

*2. For the AC coil types, the operate/release time will differ depending on the phase.

*3. The upper limit of the ambient temperature is the maximum temperature that can satisfy the coil temperature rise value. Refer to Usage, transport and storage conditions in NOTES.



Discontinued: Keep type
Last time buy: August 31, 2012

HC

3) Switching capacity and expected life

(1) Electrical (at 20 times/min.)

| Load | AC | | | | DC | | Expected life |
|-----------------|-------------------------------|---------|---------------------------------------|---------|-----------|-----------|----------------------|
| | Resistive ($\cos \phi = 1$) | | Inductive ($\cos \phi \approx 0.4$) | | Resistive | Inductive | |
| Voltage | 125V AC | 250V AC | 125V AC | 250V AC | 30V DC | 30V DC | |
| 1 Form C | 10A | 10A | 5A | 3A | — | — | Min. 2×10^5 |
| | 7A | 7A | 3A | 2.5A | 3A | 1A | Min. 5×10^5 |
| | 5A | 5A | 2A | 1.5A | — | — | Min. 10^6 |
| 2 Form C | 7A | 7A | 3.5A | 2A | — | — | Min. 2×10^5 |
| | 5A | 5A | 2.5A | 1.5A | 3A | 0.6A | Min. 5×10^5 |
| | 3A | 3A | 1.5A | 1A | — | — | Min. 10^6 |
| 3 Form C | 7A | 7A | — | — | — | — | Min. 10^5 |
| | — | — | 3.5A | 2A | — | — | Min. 2×10^5 |
| | 5A | 5A | — | — | 3A | 0.4A | Min. 5×10^5 |
| 4 Form C | 5A | 5A | 2A | 1A | — | — | Min. 2×10^5 |
| | 3A | 3A | 1A | 0.8A | 3A | 0.4A | Min. 5×10^5 |
| | 2A | 2A | 0.5A | 0.4A | — | — | Min. 10^6 |
| 4 Form C (twin) | 3A | 3A | 1A | 0.8A | 3A | — | Min. 2×10^5 |

(2) Mechanical (at 180 times/min.)

AC coil type: Min. 5×10^7 ; DC coil type: Min. 10^8

2. Amber sealed type

1) Coil data

Same coil data as HC relay standard type. Please refer to standard type information.

2) Specifications

| Characteristics | Item | Specifications | | | |
|----------------------------|---|--|------------|------------|----------------------|
| | | 1 Form C | 2 Form C | 4 Form C | 4 Form C (twin) |
| Contact | Arrangement | 1 Form C | 2 Form C | 4 Form C | 4 Form C |
| Rating | Nominal switching capacity (resistive load) | 5A 250V AC | 3A 250V AC | 2A 250V AC | 1A 250V AC |
| | Max. switching power (resistive load) | 1,250VA | 700VA | 500VA | 250VA |
| | Max. switching voltage | 250VAC | 250VAC | 250VAC | 250VAC |
| | Max. switching current | 5A | 3A | 2A | 1A |
| | Min. switching capacity (Reference value)*1 | 1mA 100mV DC | | | 100 μ A 100mV DC |
| Electrical characteristics | Temperature rise (coil) (at 60°C 140°F) | Max. 90°C 194°F (By resistive method, nominal voltage) | | | |
| Expected life | Electrical | Min. 2×10^5 resistive load (at 20 times/min.) | | | |
| Conditions | Conditions for operation, transport and storage*2 | Ambient temperature: -40°C to +60°C -40°F to +140°F; Humidity: 5 to 85% R.H. (Not freezing and condensing at low temperature) | | | |
| | Ambient air pressure | 760mmHg \pm 20% (1,013mb \pm 20%) | | | |

Notes: Other specifications are same as standard types.

*1. This value can change due to the switching frequency, environmental conditions and desired reliability level, therefore it is recommended to check this with the actual load.

*2. The upper limit of the ambient temperature is the maximum temperature that can satisfy the coil temperature rise value. Refer to Usage, transport and storage conditions in NOTES.

3) Switching capacity and expected life

(1) Electrical (at 20 times/min.)

| Load | AC | | | | DC | | Expected life |
|-----------------------|-------------------------------|---------|---------------------------------------|---------|-----------|-----------|----------------------|
| | Resistive ($\cos \phi = 1$) | | Inductive ($\cos \phi \approx 0.4$) | | Resistive | Inductive | |
| Voltage | 125V AC | 250V AC | 125V AC | 250V AC | 30V DC | 30V DC | |
| HC1E | 5A | 5A | — | — | 3A | 1A | Min. 2×10^5 |
| HC2E | 3A | 3A | — | — | 2A | 0.7A | Min. 2×10^5 |
| HC4E | 2A | 2A | — | — | 2A | 0.6A | Min. 2×10^5 |
| HC4ED (4 Form C twin) | 1A | 1A | — | — | — | — | Min. 2×10^5 |

(2) Mechanical (at 180 times/min.)

AC coil type: Min. 5×10^7 ; DC coil type: Min. 10^8

3. Keep relay

1) Coil data

(1) AC coils (50/60Hz)

| Contact arrangement | Nominal coil voltage | Set voltage (at 20°C 68°F) | Reset voltage (at 20°C 68°F) | Nominal operating current [±10%] (at 20°C 68°F) | | Nominal operating power | | Max. applied voltage (at 50°C 122°F) |
|---------------------|----------------------|---|---|---|------------|-------------------------|------------|--------------------------------------|
| | | | | Set coil | Reset coil | Set coil | Reset coil | |
| 2 Form C | 6V AC | 80%V or less of nominal voltage (Initial) | 80%V or less of nominal voltage (Initial) | 206mA | 103mA | 1.23VA | 0.62VA | 110%V of nominal voltage |
| | 12V AC | | | 100mA | 52mA | 1.20VA | 0.62VA | |
| | 24V AC | | | 51mA | 21.4mA | 1.22VA | 0.51VA | |
| | 48V AC | | | 25.2mA | 18.5mA | 1.20VA | 0.88VA | |
| | 100V AC | | | 13.3mA | 7.1mA | 1.33VA | 0.71VA | |

(2) DC coils

| Contact arrangement | Nominal coil voltage | Set voltage (at 20°C 68°F) | Reset voltage (at 20°C 68°F) | Nominal operating current [±10%] (at 20°C 68°F) | | Coil resistance [±10%] (at 20°C 68°F) | | Nominal operating power | | Max. applied voltage (at 50°C 122°F) |
|---------------------|----------------------|---|---|---|------------|---------------------------------------|------------|-------------------------|------------|--------------------------------------|
| | | | | Set coil | Reset coil | Set coil | Reset coil | Set coil | Reset coil | |
| 2 Form C | 6V DC | 80%V or less of nominal voltage (Initial) | 80%V or less of nominal voltage (Initial) | 207mA | 107mA | 29Ω | 56Ω | 1.24W | 0.64W | 110%V of nominal voltage |
| | 12V DC | | | 100mA | 52.2mA | 120Ω | 230Ω | 1.20W | 0.63W | |
| | 24V DC | | | 51.1mA | 25.5mA | 470Ω | 941Ω | 1.23W | 0.61W | |
| | 48V DC | | | 25.3mA | 13.7mA | 1,897Ω | 3,504Ω | 1.21W | 0.66W | |
| | 100V DC | | | 15.6mA | 5.8mA | 6,410Ω | 17,241Ω | 1.56W | 0.58W | |

Notes: 1. The allowable coil resistance range is ±10% when within 1,000Ω and ±15% when 1,000Ω or higher.

2. The maximum applied voltage is the maximum voltage fluctuation value for the coil power supply. This value is not a permissible value for continuous operation. (This value differs depending on the ambient temperature. Please contact us for details.)

2) Specifications

| Characteristics | Item | Specifications |
|----------------------------|--|--|
| Contact | Contact resistance (Initial) | Max. 50 mΩ (By voltage drop 6 V DC 1A) |
| Rating | Nominal switching capacity (resistive load) | 3A 250V AC |
| | Max. switching power (resistive load) | 750VA |
| | Max. switching current | 3A |
| | Nominal operating power | Set coil: 1.20VA to 1.33VA; Reset coil: 0.51VA to 0.88VA |
| | Min. switching capacity (Reference value)*1 | 100μA 100mV DC |
| Electrical characteristics | Breakdown voltage (Initial) Between contact and coil | 1,500 Vrms for 1min. |
| | Temperature rise (coil) | Set coil: Max. 80°C 176°F; Reset coil: Max. 50°C 122°F (at nominal coil voltage) |
| | Set time/Reset time (at 20°C 68°F) | Approx. 20ms/30ms (at nominal coil voltage) |
| Mechanical characteristics | Shock resistance Functional | Min. 98m/s ² (Half-wave pulse of sine wave: 11 ms; detection time: 10μs.) |
| Expected life | Mechanical | Min. 10 ⁷ (at 180 times/min.) |
| | Electrical | Min. 2×10 ⁵ rated load (at 20 times/min.) |
| Conditions | Ambient temperature | -40°C to +50°C -40°F to +122°F (Not freezing and condensing at low temperature) |

Notes: *1. This value can change due to the switching frequency, environmental conditions and desired reliability level, therefore it is recommended to check this with the actual load.

*2. Other specifications are same as standard type HC relay. Please see the standard type HC relay.

*3. Please maintain (reset) the relay more than once a year. Leaving it in the set position for long periods of time will cause the magnet to attenuate over the years. This will decrease the holding power and cause failure of the set position.

4. With diode type (For DC)

1) Coil data

Same coil data as HC relay standard type for DC. Please refer to standard type information.

Please connect DC coil type built-in diode correctly by verifying the coil polarity.

2) Specifications

| Characteristics | Item | Specifications |
|-----------------|--|---|
| Conditions | Conditions for operation, transport and storage* | Ambient temperature: -50°C to +60°C -58°F to +140°F Humidity: 5 to 85% R.H. (Not freezing and condensing at low temperature) |

Notes: Other specifications are same as standard type HC relay. Please see the standard type HC relay.

* The upper limit of the ambient temperature is the maximum temperature that can satisfy the coil temperature rise value. Refer to Usage, transport and storage conditions in NOTES.

5. With CR circuit type

1) Coil data

Same coil data as HC relay standard type for AC. Please refer to standard type information.

2) Specifications

| Characteristics | Item | Specifications |
|----------------------------|--|---|
| Electrical characteristics | Temperature rise (coil) | Max. 90°C 194°F (By resistive method, nominal voltage, rated current at 60°C 140°F) |
| Conditions | Conditions for operation, transport and storage* | Ambient temperature: -50°C to +60°C -58°F to +140°F Humidity: 5 to 85% R.H. (Not freezing and condensing at low temperature) |

Notes: Other specifications are same as standard type HC relay. Please see the standard type HC relay.

* The upper limit of the ambient temperature is the maximum temperature that can satisfy the coil temperature rise value. Refer to Usage, transport and storage conditions in NOTES.



Discontinued: Keep type
Last time buy: August 31, 2012

REFERENCE DATA

Standard type

1. Life curve

Load: 250 V AC resistive load

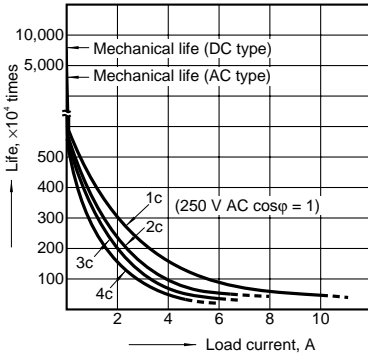

2.-(1) Switching capacity range (single contact type)

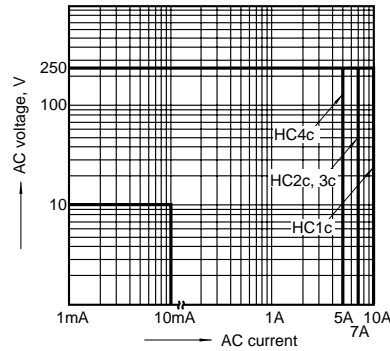

2.-(2) Switching capacity range (4-pole bifurcated (twin) contact type)

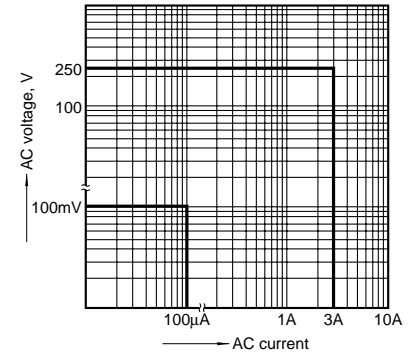

3.-(1) Coil temperature rise (1 Form C, AC type)

Measured portion: Inside the coil
 Ambient temperature: 25°C 77°F

(See note.)

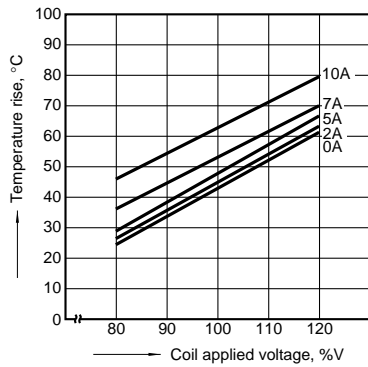

3.-(2) Coil temperature rise (2 Form C, AC type)

Measured portion: Inside the coil
 Ambient temperature: 30°C 86°F

(See note.)

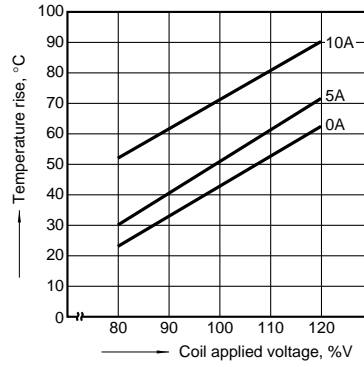

3.-(3) Coil temperature rise (3 Form C, AC type)

Measured portion: Inside the coil
 Ambient temperature: 18°C 64°F

(See note.)

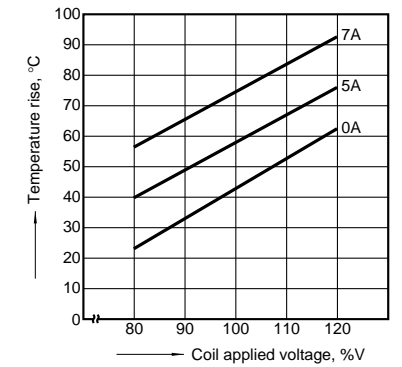

3.-(4) Coil temperature rise (4 Form C, AC type)

Measured portion: Inside the coil
 Ambient temperature: 15 to 21°C 59 to 70°F

(See note.)

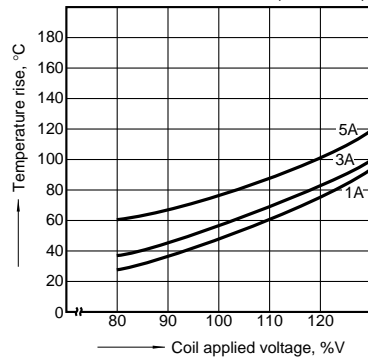

3.-(5) Coil temperature rise (1 Form C, DC type)

Measured portion: Inside the coil
 Ambient temperature: 29°C 84°F

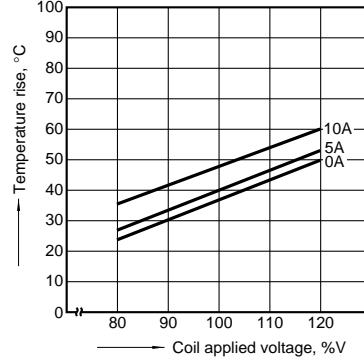

3.-(6) Coil temperature rise (2 Form C, DC type)

Measured portion: Inside the coil
 Ambient temperature: 29°C 84°F

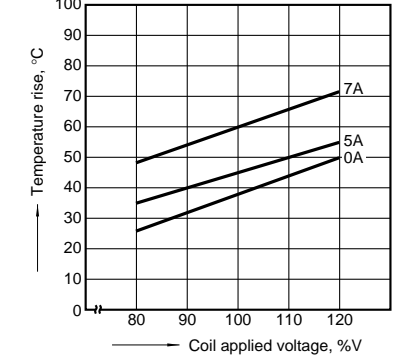

3.-(7) Coil temperature rise (3 Form C, DC type)

Measured portion: Inside the coil
 Ambient temperature: 29°C 84°F

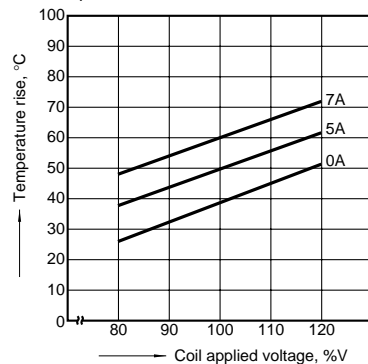

3.-(8) Coil temperature rise (4 Form C, DC type)

Measured portion: Inside the coil
 Ambient temperature: 17 to 18°C 62 to 64°F

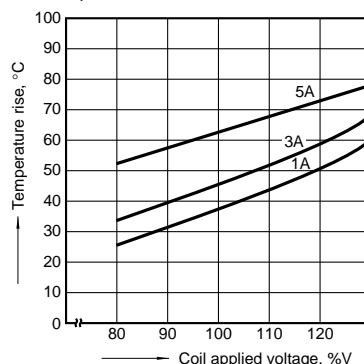

Note: Coil temperature rise

When the nominal voltage is applied to AC 120 or 240 V coil types respectively, the figures of coil temperature rise increase by approx. 10 degrees to the ones shown on each graph.

Amber sealed type

1.-(1) Switching capacity range
 (single contact type)

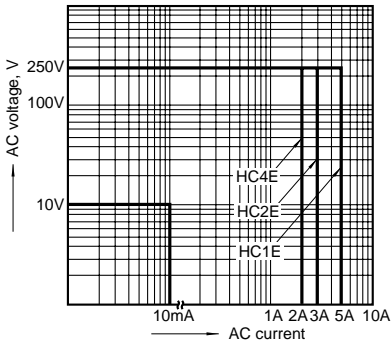

1.-(2) Switching capacity range
 (4-pole bifurcated (twin) contact type)

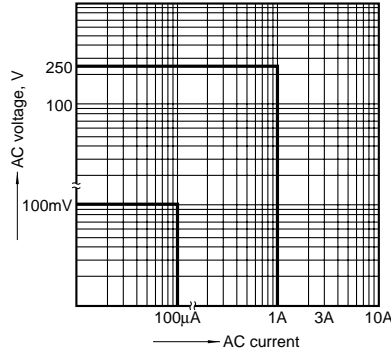

2.-(1) Coil temperature rise (1 Form C AC type)
 Measured portion: Inside the coil
 Ambient temperature: 30°C 86°F

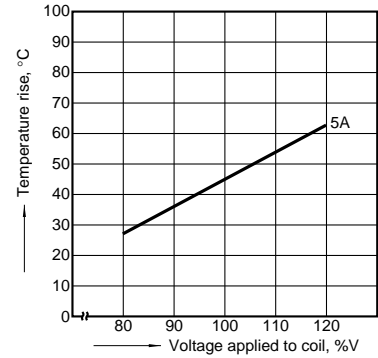

2.-(2) Coil temperature rise (2 Form C AC type)
 Measured portion: Inside the coil
 Ambient temperature: 30°C 86°F (See note.)

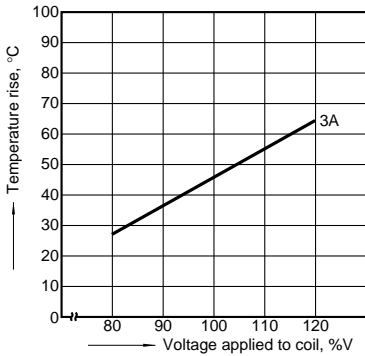

2.-(3) Coil temperature rise (4 Form C AC type)
 Measured portion: Inside the coil
 Ambient temperature: 30°C 86°F (See note.)

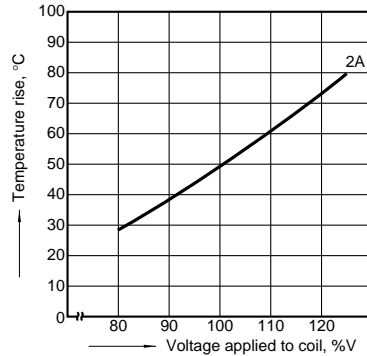

2.-(4) Coil temperature rise (1 Form C DC type)
 Measured portion: Inside the coil
 Ambient temperature: 30°C 86°F

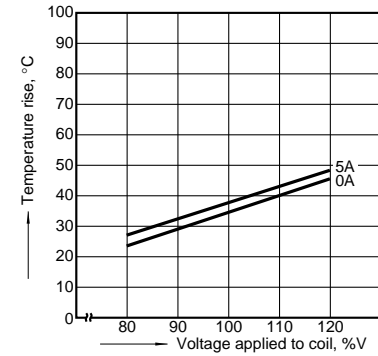

2.-(5) Coil temperature rise (2 Form C DC type)
 Measured portion: Inside the coil
 Ambient temperature: 30°C 86°F

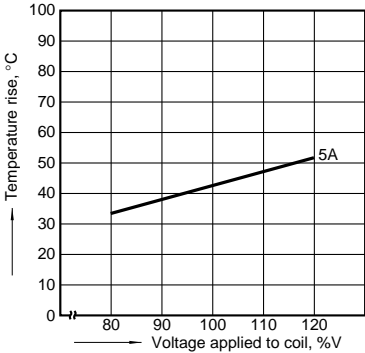

Note: Coil temperature rise

When the nominal voltage is applied to AC 120 or 240 V coil types respectively, the figures of coil temperature rise increase by approx. 10 degrees to the ones shown on each graph.

⚠ Keep relay
 Coil temperature rise
 Tested sample: HC2K-DC12V, 2 pcs
 Measured portion: Inside the coil
 Ambient temperature: 28°C 82.4°F



Discontinued: Keep type
Last time buy: August 31, 2012

With diode type (For DC)

1.-(1) DC coil surge voltage waveform
 (without diode)

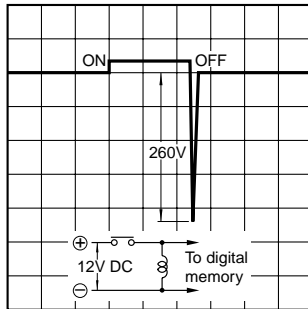

1.-(2) DC coil surge voltage waveform
 (with diode)

Diode characteristics;
 Reverse breakdown voltage: 1,000V,
 Forward current: 1A

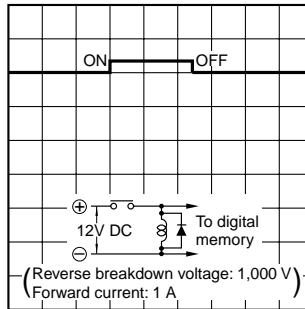

With CR circuit type

1.-(1) AC coil surge voltage waveform
 (with CR circuit)

Tested sample: HC4-AC200V-R

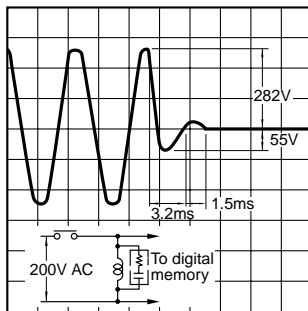

1.-(2) AC coil surge voltage waveform
 (without CR circuit)

Tested sample: HC4-AC200V

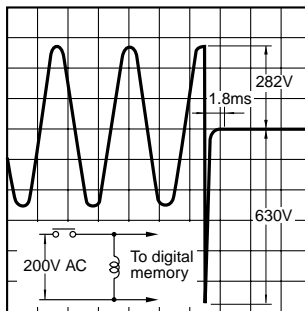

DIMENSIONS (mm inch)

Standard and Amber sealed types

1) Plug-in type
 1) Form C

CAD Data



The CAD data of the products with a **CAD Data** mark can be downloaded from: <http://industrial.panasonic.com/ac/e>

External dimensions

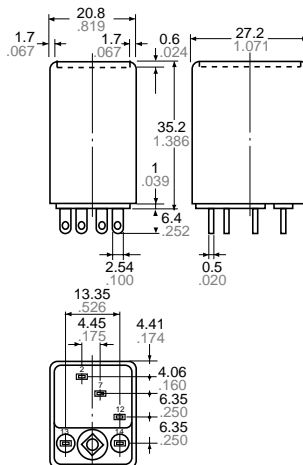

Schematic (Bottom view)

Standard type

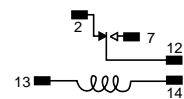

LED AC type

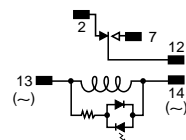

LED DC type

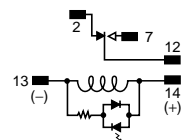

General tolerance: $\pm 0.3 \pm 0.12$

2 Form C

CAD Data



External dimensions

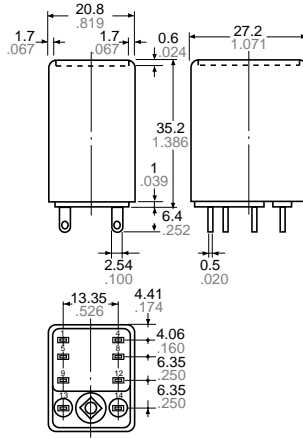

Schematic (Bottom view)

Standard type

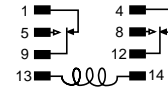

LED AC type

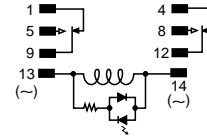

LED DC type

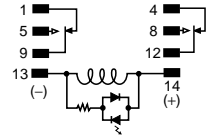

General tolerance: $\pm 0.3 \pm 0.012$

3 Form C

CAD Data



External dimensions

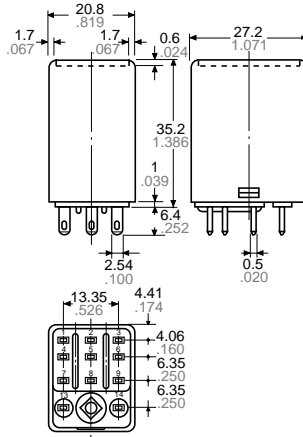

Schematic (Bottom view)

Standard type

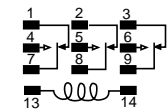

LED AC type

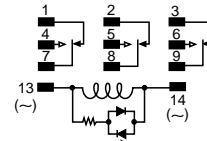

LED DC type

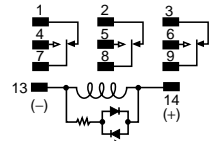

General tolerance: $\pm 0.3 \pm 0.012$

4 Form C and 4-pole bifurcated (twin)

CAD Data



External dimensions

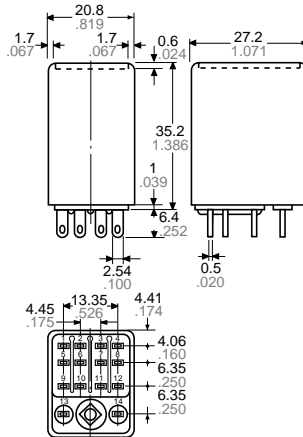

Schematic (Bottom view)

Standard type

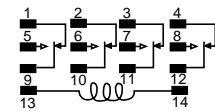

LED AC type

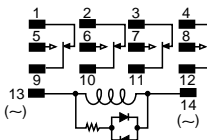

LED DC type

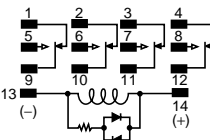

General tolerance: $\pm 0.3 \pm 0.012$

2) PC board type
 4 Form C

CAD Data



External dimensions

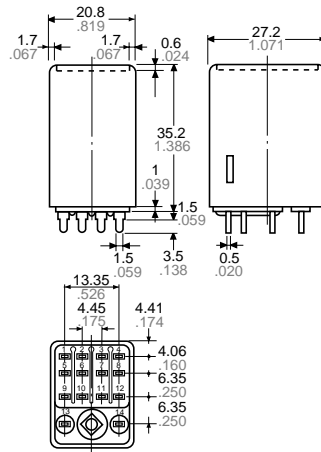

General tolerance: $\pm 0.3 \pm 0.12$

The diagrams show the external dimensions of the 4 Form C and 4-pole bifurcated (twin) types. For 1 Form C, 2 Form C, and 3 Form C, see diagrams at plug-in types (only the terminals are different). Types with 0.9 mm terminal width are also available.

PC board pattern

1 Form C

2 Form C

3 Form C

4 Form C

Schematic

Same schematic as plug-in type HC relay

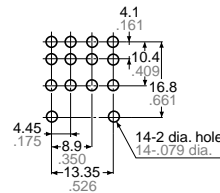
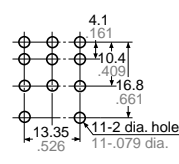
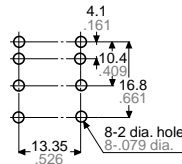
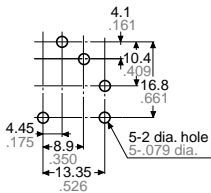

Tolerance: $\pm 0.1 \pm 0.004$

3) TM type
 4 Form C

CAD Data

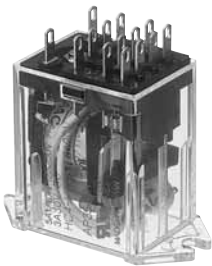

External dimensions

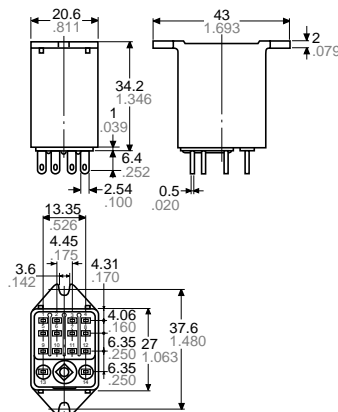

General tolerance: $\pm 0.3 \pm 0.12$

The diagrams show the external dimensions of the 4 Form C and 4-pole bifurcated (twin) types. For 1 Form C, 2 Form C, and 3 Form C, see diagrams at plug-in types (only the terminals are different).

Chassis (Panel) cutout

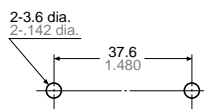

Tolerance: $\pm 0.1 \pm 0.004$

Chassis (Panel) cutout in tandem mounting

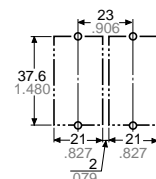

Schematic

Same schematic as plug-in type HC relay
 Be aware that there is no LED indicator with CR circuit and built-in diode types.

- Notes: 1. In mounting, use M3 screws and M3 washers.
 2. When mounting TM types, use washers to prevent damage or distortion to the polycarbonate cover.
 3. When tightening fixing screws, the optimum torque range should be 0.294 to 0.49 N-m, (3 to 5 kgf-cm). Moreover, use washers to prevent loosening.

HC

Discontinued: Keep type
Last time buy: August 31, 2012

Keep relay
 Plug-in type (2 Form C)

CAD Data



External dimensions

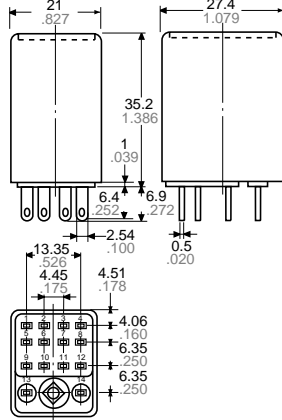

General tolerance: $\pm 0.3 \pm 0.12$

Schematic (Bottom view)

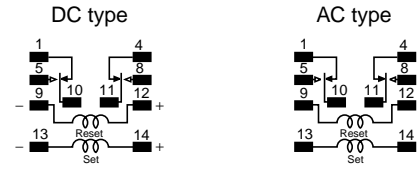

PC board type (2 Form C)

CAD Data



External dimensions

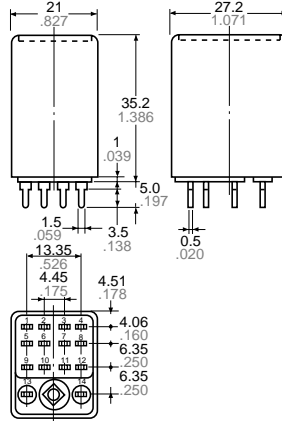

General tolerance: $\pm 0.3 \pm 0.12$

Schematic (Bottom view)

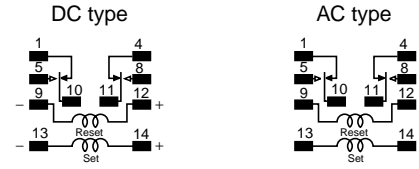

PC board pattern (Bottom view)

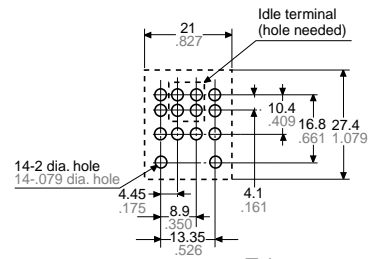

Tolerance: $\pm 0.1 \pm 0.004$

With diode type (For DC)

Same dimensions as HC relay standard/plug-in type

CAD Data



Schematic

Without LED indicator

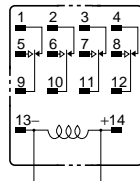

Protection (surge-absorbing) diode

With LED indicator

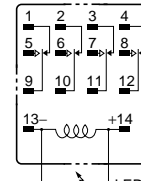

Protection (surge-absorbing) diode

With CR circuit type

Plug-in type

CAD Data



4 Form C External dimensions

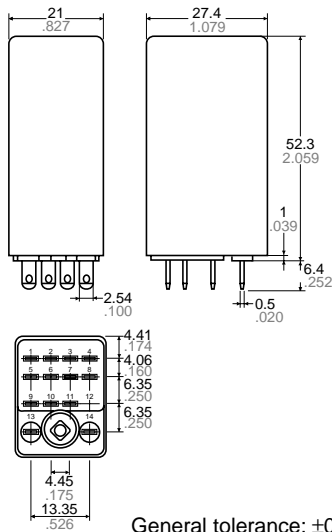

Diagrams show the external dimensions and schematic of the 4 Form C and 4-pole bifurcated (twin) types. For the 1 Form C, 2 Form C, and 3 Form C types, only the terminals differ. The dimensions of the terminal are the same as for standard type HC relays.

General tolerance: $\pm 0.3 \pm 0.12$

Schematic

Without LED indicator With LED indicator

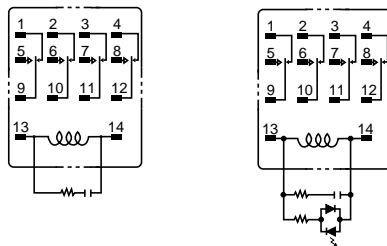

SAFETY STANDARDS

| Item | UL/C-UL (Recognized) | | CSA (Certified) | | VDE (Certified) | | TV rating (UL/CSA) | | Remarks |
|-------------|----------------------|--|-----------------|--|-----------------|--|--------------------------------|--------|-------------------------|
| | File No. | Contact rating | File No. | Contact rating | File No. | Contact rating | File No. | Rating | |
| HC Standard | 1 Form C | E43028 10A 250V AC 1/8HP 125, 250V AC 3A 30V DC | LR26550 etc. | 10A 250V AC 1/8HP 125, 250V AC 3A 30V DC | 40017406 | 10A 250V AC (cosφ=1.0) 3A 250V AC (cosφ=0.4) 3A 30V DC (0ms) | UL E43149 CSA LR26550 | TV-3 | |
| | 2 Form C | E43028 7A 250V AC 1/8HP 125, 250V AC 3A 30V DC | LR26550 etc. | 7A 250V AC 1/8HP 125, 250V AC 3A 30V DC | 40017406 | 7A 250V AC (cosφ=1.0) 2A 250V AC (cosφ=0.4) 3A 30V DC (0ms) | UL E43149 CSA LR26550 | TV-3 | |
| | 3 Form C | E43028 7A 250V AC 1/8HP 125, 250V AC 3A 30V DC | LR26550 etc. | 7A 250V AC 1/8HP 125, 250V AC 3A 30V DC | — | — | — | — | |
| | 4 Form C | E43028 5A 250V AC 1/10HP 125, 250V AC 3A 30V DC | LR26550 etc. | 5A 250V AC 1/10HP 125, 250V AC 3A 30V DC | 40017406 | 5A 65V AC (cosφ=1.0) 3A 65V AC (cosφ=0.4) 3A 30V DC (0ms) | — | — | |
| | 4 Form C twin | E43149 3A 250V AC 3A 30V DC | LR26550 etc. | 3A 250V AC 3A 30V DC | — | — | — | — | |
| HC Amber | 1 Form C | E43028 6A 250V AC 1/8HP 125, 250V AC 3A 30V DC | LR26550 etc. | 6A 250V AC 1/8HP 125, 250V AC 3A 30V DC | — | — | — | — | |
| | 2 Form C | E43028 4A 250V AC 1/10HP 125, 250V AC 3A 30V DC | LR26550 etc. | 4A 250V AC 1/10HP 125, 250V AC 3A 30V DC | — | — | — | — | |
| | 4 Form C | E43028 2A 250V AC 1/20HP 125, 250V AC 2A 30V DC | LR26550 etc. | 2A 250V AC 1/20HP 125, 250V AC 2A 30V DC | — | — | — | — | |
| | 4 Form C twin | E43149 1A 250V AC 1A 30V DC | LR26550 etc. | 1A 250V AC 1A 30V DC | — | — | — | — | |
| HC keep | E43149 | 3A 250V AC 3A 30V DC | LR26550 etc. | 3A 250V AC 3A 30V DC | — | — | — | — | Approved (DC type only) |

| Item | UL/C-UL (Recognized) | | CSA (Certified) | | VDE (Certified) | | TV rating (UL/CSA) | | Remarks |
|-----------------------------|----------------------|--|-----------------|--|-----------------|----------------|--------------------|--------|---------|
| | File No. | Contact rating | File No. | Contact rating | File No. | Contact rating | File No. | Rating | |
| HC with diode type (For DC) | 1 Form C | E43028 10A 250V AC 1/3HP 125, 250V AC 3A 30V DC | LR26550 etc. | 10A 250V AC 1/3HP 125, 250V AC 3A 30V DC | — | — | — | — | |
| | 2 Form C | E43028 7A 250V AC 1/6HP 125, 250V AC 3A 30V DC | LR26550 etc. | 7A 250V AC 1/6HP 125, 250V AC 3A 30V DC | — | — | — | — | |
| | 3 Form C | E43028 7A 250V AC 1/6HP 125, 250V AC 3A 30V DC | LR26550 etc. | 7A 250V AC 1/6HP 125, 250V AC 3A 30V DC | — | — | — | — | |
| | 4 Form C | E43028 5A 250V AC 1/10HP 125, 250V AC 3A 30V DC | LR26550 etc. | 5A 250V AC 1/10HP 125, 250V AC 3A 30V DC | — | — | — | — | |
| | 4 Form C twin | E43149 3A 250V AC 3A 30V DC | LR26550 etc. | 3A 250V AC 3A 30V DC | — | — | — | — | |
| HC with CR circuit | 1 Form C | E43028 10A 250V AC 1/3HP 125, 250V AC 3A 30V DC | LR26550 etc. | 10A 250V AC 1/3HP 125, 250V AC 3A 30V DC | — | — | — | — | |
| | 2 Form C | E43028 7A 250V AC 1/6HP 125, 250V AC 3A 30V DC | LR26550 etc. | 7A 250V AC 1/6HP 125, 250V AC 3A 30V DC | — | — | — | — | |
| | 3 Form C | E43028 7A 250V AC 1/6HP 125, 250V AC 3A 30V DC | LR26550 etc. | 7A 250V AC 1/6HP 125, 250V AC 3A 30V DC | — | — | — | — | |
| | 4 Form C | E43028 5A 250V AC 1/10HP 125, 250V AC 3A 30V DC | LR26550 etc. | 5A 250V AC 1/10HP 125, 250V AC 3A 30V DC | — | — | — | — | |
| | 4 Form C twin | E43149 3A 250V AC 3A 30V DC | LR26550 etc. | 3A 250V AC 3A 30V DC | — | — | — | — | |

NOTES

1. Amber sealed type

When mounting TM types, use washers to prevent damage or distortion to the polycarbonate cover. When tightening fixing screws, the optimum torque range should be 0.294 to 0.49 N·m, (3 to 5 kgf·cm). If screws are over tightened, the cover may distort, resulting in poor sealing. Moreover, to prevent loosening, use washers.

2. Keep relay

- 1) The schematic differs from that in the standard type 4 Form C HC relay. Follow the schematic on the cover sticker.
- 2) Conform with the schematic for the DC type, which has a polarized coil.

3) Because retention characteristics vary according to the waveform of the voltage applied to the coil, do your best to avoid capacitor driving.

In capacitor driving, use a capacitor of 300 μF or more.

4) Ensure that the minimum pulse width of voltage applied to coil is greater than 150 ms.

3. Diode characteristics

- 1) Reverse breakdown voltage: 1,000 V
- 2) Forward current: 1 A

4. Diode and CR built-in type

Since the diode and CR inside the relay coil are designed to absorb the counter emf, the element may be damaged if a

large surge, etc., is applied to the diode and CR.

If there is the possibility of a large surge voltage from the outside, please implement measures to absorb it.

5. Please connect DC coil types with LED and built-in diode correctly by verifying the coil polarity (“+” and “-”). Connecting with reverse polarity will cause the LED not to light and damage the built-in diode due to its specification.

For Cautions for Use.