

阅读申明

- 1.本站收集的数据手册和产品资料都来自互联网，版权归原作者所有。如读者和版权方有任何异议请及时告之，我们将妥善解决。
- 2.本站提供的中文数据手册是英文数据手册的中文翻译，其目的是协助用户阅读，该译文无法自动跟随原稿更新，同时也可能存在翻译上的不当。建议读者以英文原稿为参考以便获得更精准的信息。
- 3.本站提供的产品资料，来自厂商的技术支持或者使用者的心得体会等，其内容可能存在描述上的差异，建议读者做出适当判断。
- 4.如需与我们联系，请发邮件到marketing@iczoom.com，主题请标有“数据手册”字样。

Read Statement

1. The datasheets and other product information on the site are all from network reference or other public materials, and the copyright belongs to the original author and original published source. If readers and copyright owners have any objections, please contact us and we will deal with it in a timely manner.
2. The Chinese datasheets provided on the website is a Chinese translation of the English datasheets. Its purpose is for reader's learning exchange only and do not involve commercial purposes. The translation cannot be automatically updated with the original manuscript, and there may also be improper translations. Readers are advised to use the English manuscript as a reference for more accurate information.
3. All product information provided on the website refer to solutions from manufacturers' technical support or users the contents may have differences in description, and readers are advised to take the original article as the standard.
4. If you have any questions, please contact us at marketing@iczoom.com and mark the subject with "Datasheets" .

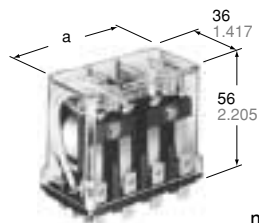

mm inch

| | a |
|-----|------------|
| HG2 | 34.0 1.339 |
| HG3 | 50.0 1.969 |
| HG4 | 68.0 2.667 |

FEATURES

- Large capacity — 20 A 250 V AC resistive and 1.5 kW 3 phase 220 V AC motor loads
- High contact reliability after long use
- Usable with direct soldering, quick-connect and plug-in terminals. (.250)

SPECIFICATIONS

Contacts

| | |
|--|------------------------------|
| Arrangement | 2 Form C, 3 Form C, 4 Form C |
| Initial contact resistance, max. (By voltage drop 6 V DC 1A) | 15 mΩ |
| Contact material | Silver alloy |
| Nominal switching capacity | 20 A 250 V AC (resistive) |
| Min. switching capacity ^{#1} | 100 mA, 5 V DC |

Expected life (min. operations)

| | |
|-------------------------|---|
| Mechanical (at 180 cpm) | AC type: 10 ⁷ , DC type: 10 ⁶ |
|-------------------------|---|

Life curve for AC types

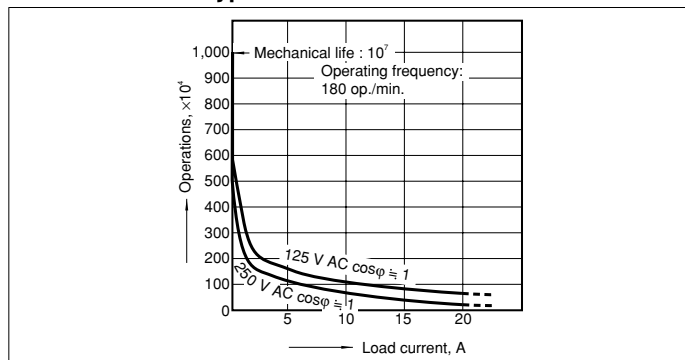

#1 This value can change due to the switching frequency, environmental conditions, and desired reliability level, therefore it is recommended to check this with the actual load.

Remarks

* Specifications will vary with foreign standards certification ratings.

*1 Measurement at same location as "Initial breakdown voltage" section

Characteristics (at 60 Hz, 20°C 68°F)

| | | |
|--|---------------------------|--|
| Maximum operating speed | 20 cpm | |
| Initial insulation resistance*1 | Min. 100 MΩ at 500 V DC | |
| Initial breakdown voltage*2 | Between open contacts | 2,000 Vrms for 1 min. |
| | Between contacts sets | 2,000 Vrms for 1 min. |
| | Between contacts and coil | 2,000 Vrms for 1 min. |
| Operate time*3 (approx.) (at nominal voltage) | 2 Form C type | Max. 30 ms |
| | 3 Form C & 4 Form C type | Max. 40 ms |
| Release time (without diode)*3 (approx.) (at nominal voltage) | 2 Form C type | Max. 30 ms |
| | 3 Form C & 4 Form C type | Max. 40 ms |
| Shock resistance | Functional*4 | 98 m/s ² {10 G} (except for the contact moving direction) |
| | Destructive*5 | 980 m/s ² {100 G} |
| Vibration resistance | Functional*6 | 10 to 55 Hz at 1 mm double amplitude |
| | Destructive | 10 to 55 Hz at 2 mm double amplitude |
| Conditions for operation, transport and storage*7 (Not freezing and condensing at low temperature) | Ambient temp. | -50°C to +40°C -58°F to +104°F |
| | Humidity | 5 to 85% R.H. |
| Unit weight | 2 Form C type | Approx. 130 g 4.59 oz |
| | 3 Form C type | Approx. 185 g 6.53 oz |
| | 4 Form C type | Approx. 240 g 8.47 oz |

*2 Detection current: 10 mA

*3 Excluding contact bounce time

*4 Half-wave pulse of sine wave: 11 ms; detection time: 10μs

*5 Half-wave pulse of sine wave: 6 ms

*6 Detection time: 10μs

*7 Refer to 6. Conditions for operation, transport and storage mentioned in AMBIENT ENVIRONMENT

Electrical life with AC load

| AC load | Voltage, V AC | Current, A | Expected life (min. operations) |
|-------------------------|---------------|------------|---------------------------------|
| Resistive (cos φ ≈ 1) | 125 | 20 | 5×10 ⁵ |
| | | 15 | 7.5×10 ⁵ |
| | 250 | 20 | 2×10 ⁵ |
| | | 15 | 5×10 ⁵ |
| Inductive (cos φ ≈ 0.4) | 125 | 10 | 7.5×10 ⁵ |
| | | 15 | 2×10 ⁵ |
| | 250 | 10 | 5×10 ⁵ |
| | | 10 | 2×10 ⁵ |
| | | 7.5 | 5×10 ⁵ |

Note: In case of an electromagnet or exiting coil load (solenoid, etc.), the value of the motor or lamp load is applicable.

| AC load | Voltage, V AC | Capacity, kW | Expected life (min. operations) |
|---------|---------------|--------------|---------------------------------|
| Lamp | 125 | 0.5 | 2×10 ⁵ |
| | | 0.3 | 5×10 ⁵ |
| Motor | 125 | 0.75 | 2×10 ⁵ |
| | | 0.4 | 5×10 ⁵ |
| | | 0.75 | 2×10 ⁵ |
| | 250 | 0.4 | 5×10 ⁵ |
| | | 1.5 | 2×10 ⁵ |
| | | 0.75 | 5×10 ⁵ |

Electrical life with DC load

| DC load | Voltage, V DC | Current, A | Expected life (min. operations) |
|------------------------|---------------|------------|---------------------------------|
| Resistive | 24 | 15 | 5×10 ⁵ |
| | 125 | 0.8 | 5×10 ⁵ |
| Inductive (L/R ≈ 7 ms) | 24 | 10 | 5×10 ⁵ |
| | 125 | 0.4 | 5×10 ⁵ |

Note: For DC inductive load, use of an arc extinguishing circuit is recommended.

TYPICAL APPLICATIONS

Industrial machinery, machine tools, food processing and packing machines, office machines, transportation equipment and amusement devices.

ORDERING INFORMATION

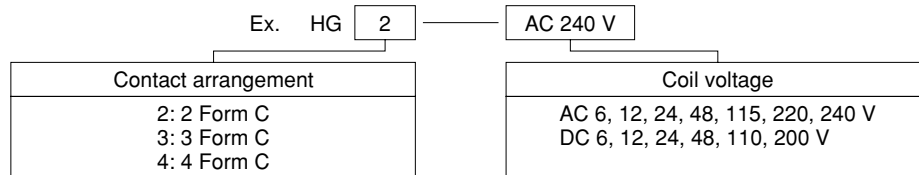

(Note) Standard packing Carton: HG2 20 pcs. Case: HG2 100 pcs.
 HG3, HG4 10 pcs. HG3, HG4 50 pcs.
 UL/CSA approved type is standard.

TYPES AND COIL DATA

DC TYPES at 20°C 68°F

| Type | Part No. | Nominal coil voltage, V DC | Pick-up voltage, V DC (max.) | Drop-out voltage, V DC (min.) | Max. allowable, V DC voltage | Coil resistance, Ω (±10%) | Nominal coil current, mA | Operating power, W |
|-------------------|------------|----------------------------|------------------------------|-------------------------------|------------------------------|---------------------------|--------------------------|--------------------|
| HG2 (2 Form C) | HG2-DC6V | 6 | 4.8 | 0.9 | 6.6 | 26.4 | 230 | (approx.) 1.4 |
| | HG2-DC12V | 12 | 9.6 | 1.8 | 13.2 | 100 | 119.6 | (approx.) 1.4 |
| | HG2-DC24V | 24 | 19.2 | 3.6 | 26.4 | 416 | 57.6 | (approx.) 1.4 |
| | HG2-DC48V | 48 | 38.4 | 7.2 | 52.8 | 1585 | 30.3 | (approx.) 1.4 |
| | HG2-DC110V | 110 | 88 | 16.5 | 121 | 7650 | 14.4 | (approx.) 1.4 |
| | HG2-DC200V | 200 | 160 | 20 | 220 | 27,800 | 7.2 | (approx.) 1.4 |
| HG3 (3 Form C) | HG3-DC6V | 6 | 4.8 | 0.9 | 6.6 | 22.7 | 264 | (approx.) 1.6 |
| | HG3-DC12V | 12 | 9.6 | 1.8 | 13.2 | 89.5 | 134 | (approx.) 1.6 |
| | HG3-DC24V | 24 | 19.2 | 3.6 | 26.4 | 364 | 66 | (approx.) 1.6 |
| | HG3-DC48V | 48 | 38.4 | 7.2 | 52.8 | 1450 | 33.1 | (approx.) 1.6 |
| | HG3-DC110V | 110 | 88 | 16.5 | 121 | 6670 | 16.5 | (approx.) 1.6 |
| | HG3-DC200V | 200 | 160 | 20 | 220 | 23,800 | 8.4 | (approx.) 1.6 |
| HG4 (4 Form C) | HG4-DC6V | 6 | 4.8 | 0.9 | 6.6 | 18.5 | 325 | (approx.) 2.1 |
| | HG4-DC12V | 12 | 9.6 | 1.8 | 13.2 | 71.4 | 168 | (approx.) 2.1 |
| | HG4-DC24V | 24 | 19.2 | 3.6 | 26.4 | 296 | 81.2 | (approx.) 2.1 |
| | HG4-DC48V | 48 | 38.4 | 7.2 | 52.8 | 1050 | 45.7 | (approx.) 2.1 |
| | HG4-DC110V | 110 | 88 | 16.5 | 121 | 5420 | 20.3 | (approx.) 2.1 |
| | HG4-DC200V | 200 | 160 | 20 | 220 | 15,500 | 12.9 | (approx.) 2.1 |

AC TYPES (50/60 Hz) at 60 HZ, 20°C 68°F

| Type | Part No. | Nominal coil voltage, V AC | Pick-up voltage, V AC (max.) | Drop-out voltage, V AC (min.) | Max. allowable, V AC voltage | Inductance, H | Nominal coil current, mA | Operating power, VA |
|-------------------|------------|----------------------------|------------------------------|-------------------------------|------------------------------|---------------|--------------------------|---------------------|
| HG2 (2 Form C) | HG2-AC6V | 6 | 4.8 | 1.8 | 6.6 | 0.026 | 600 | (approx.) 3.6 |
| | HG2-AC12V | 12 | 9.6 | 3.6 | 13.2 | 0.104 | 300 | (approx.) 3.6 |
| | HG2-AC24V | 24 | 19.2 | 7.2 | 26.4 | 0.416 | 150 | (approx.) 3.6 |
| | HG2-AC48V | 48 | 38.4 | 14.4 | 52.8 | 1.660 | 75 | (approx.) 3.6 |
| | HG2-AC115V | 115 | 92 | 34.5 | 126.5 | 9.531 | 31.3 | (approx.) 3.6 |
| | HG2-AC220V | 220 | 176 | 66 | 242 | 34.96 | 16.4 | (approx.) 3.6 |
| | HG2-AC240V | 240 | 192 | 72 | 264 | 41.68 | 15 | (approx.) 3.6 |
| HG3 (3 Form C) | HG3-AC6V | 6 | 4.8 | 1.8 | 6.6 | 0.018 | 864 | (approx.) 5.2 |
| | HG3-AC12V | 12 | 9.6 | 3.6 | 13.2 | 0.073 | 432 | (approx.) 5.2 |
| | HG3-AC24V | 24 | 19.2 | 7.2 | 26.4 | 0.290 | 216 | (approx.) 5.2 |
| | HG3-AC48V | 48 | 38.4 | 14.4 | 52.8 | 1.163 | 108 | (approx.) 5.2 |
| | HG3-AC115V | 115 | 92 | 34.5 | 126.5 | 6.648 | 45.2 | (approx.) 5.2 |
| | HG3-AC220V | 220 | 176 | 66 | 242 | 24.26 | 23.6 | (approx.) 5.2 |
| | HG3-AC240V | 240 | 192 | 72 | 264 | 29.06 | 21.6 | (approx.) 5.2 |
| HG4 (4 Form C) | HG4-AC6V | 6 | 4.8 | 1.8 | 6.6 | 0.012 | 1264 | (approx.) 7.6 |
| | HG4-AC12V | 12 | 9.6 | 3.6 | 13.2 | 0.050 | 632 | (approx.) 7.6 |
| | HG4-AC24V | 24 | 19.2 | 7.2 | 26.4 | 0.199 | 316 | (approx.) 7.6 |
| | HG4-AC48V | 48 | 38.4 | 14.4 | 52.8 | 0.795 | 158 | (approx.) 7.6 |
| | HG4-AC115V | 115 | 92 | 34.5 | 126.5 | 4.557 | 66.1 | (approx.) 7.6 |
| | HG4-AC220V | 220 | 176 | 66 | 242 | 16.89 | 34 | (approx.) 7.6 |
| | HG4-AC240V | 240 | 192 | 72 | 264 | 19.87 | 31.6 | (approx.) 7.6 |

Notes:

1. The coil current ranges is ±15% for AC (60 Hz), ±10% for DC (20°C 68°F).
 2. These relays are applicable to a range of 80% to 110% of the nominal coil voltage. However, it is recommended that the relay be used in a range of 85% to 110% of the nominal coil voltage, taking the temporary voltage variation into consideration. For AC types, when operating voltage is 70% of nominal coil voltage, "buzzing" will

occur, and a large amount of current will flow, burning the coil.
 3. Each coil resistance of DC types is the measured value at coil temperature of 20°C 68°F. Please compensate the coil resistance by ±0.4%, each time the coil temperature changes by ±1°C.

DIMENSIONS

HG2 (2 Form C)

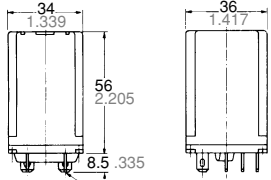
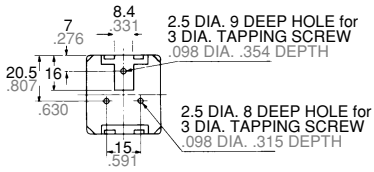

AMP SERIES FASTON 250 CONNECTORS CAN BE USED

Schematic (Bottom view)

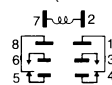
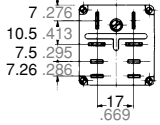

HG3 (3 Form C)

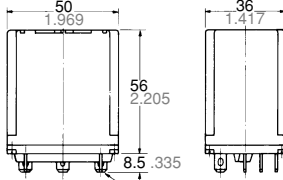
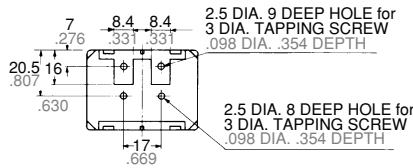

AMP SERIES FASTON 250 CONNECTORS CAN BE USED

Schematic (Bottom view)

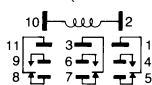
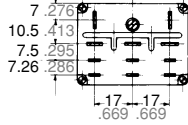

HG4 (4 Form C)

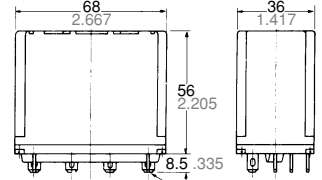
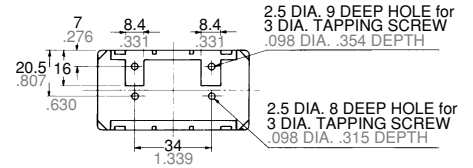

AMP SERIES FASTON 250 CONNECTORS CAN BE USED

Schematic (Bottom view)

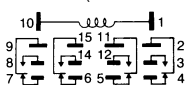
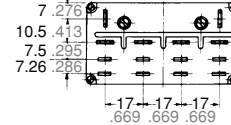

General tolerance: $\pm 0.5 \pm .020$

ACCESSORIES

Please refer to "MOUNTING METHOD" for further information.

| HG | Relay | Screw terminal socket for DIN rail assembly (with hold-down clip) | Solder terminal socket for rectangular hole (with hold-down clip) | Bracket for direct mounting |
|----------------|-------|---|---|-----------------------------|
| HG2 (2 Form C) | | HG2-SFD | HG2-SS | HP-BRACKET 1 pc. |
| HG3 (3 Form C) | | HG3-SFD | HG3-SS | HP-BRACKET 2 pcs. |
| HG4 (4 Form C) | | No screw terminal socket for HG4 use 2 screw terminal sockets (HG2-SFD) | HG4-SS | HP-BRACKET 2 pcs. |

Note: Tapping-screw holes are provided on the cover top for direct mounting.

MOUNTING METHOD AND DIMENSIONS

mm inch

Screw terminal socket (Hold-down clips included)

HG2-SFD

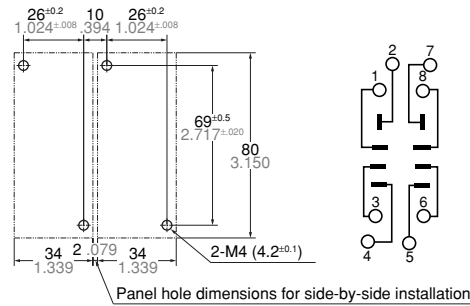
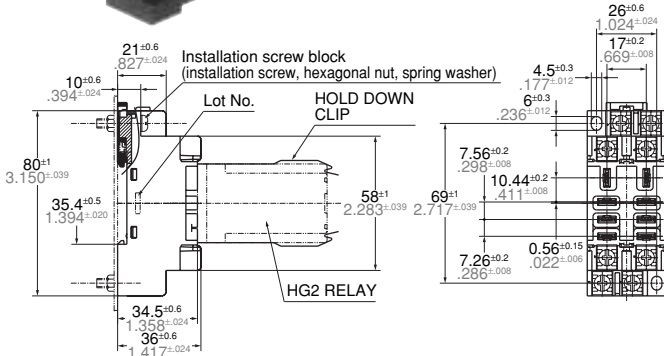

HG3-SFD

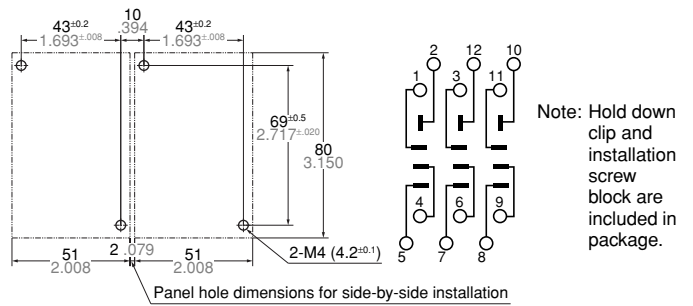
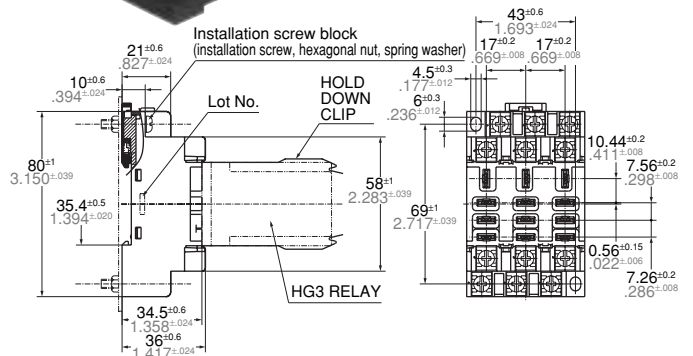

Solder terminal socket (Hold-down clips included)

HG2-SS

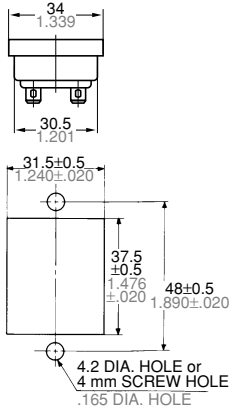
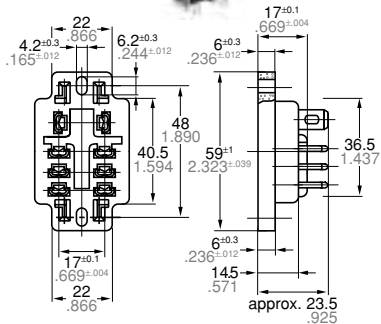

HG3-SS

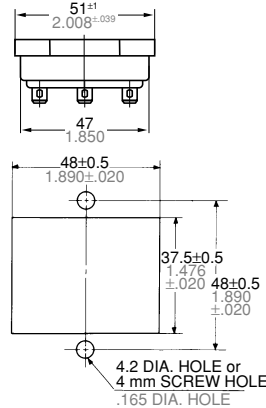
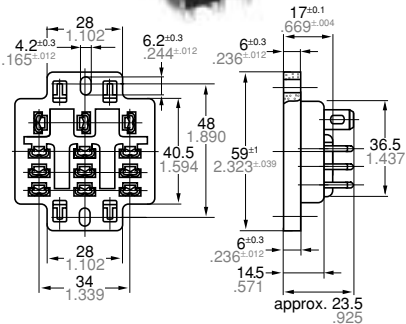

HG4-SS

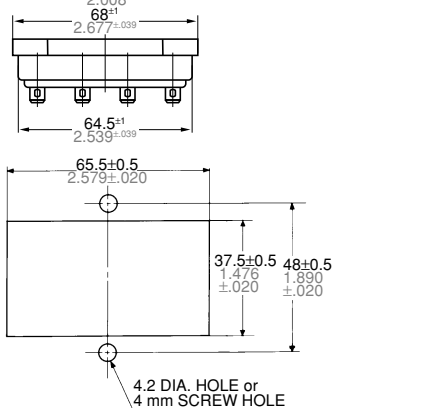
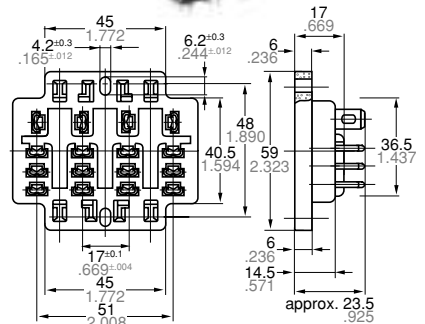

Note: HG sockets accept Faston 250.

General tolerance: ±0.6 ±0.024

Direct mounting

Faston 250 series quick-connectors can be used.

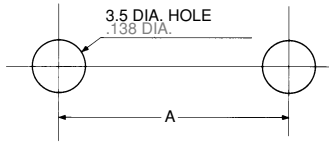
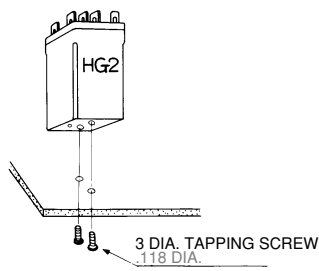

A: HG 2: 15mm .591
 HG 3: 17mm .669
 HG 4: 34mm 1.339

Direct mounting with HP-BRACKET

Faston 250 series quick-connectors can be used.

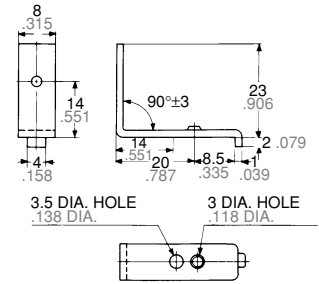
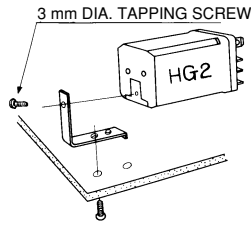

Use two brackets for HG3 and HG4

Notes:

1. This bracket is unavailable for UL, CSA and VDE applications.
2. When using any other non-standard bracket mounting-screw length should not exceed bracket thickness plus 7 mm .276 inch to avoid damage to relay coils.

Socket Combinations

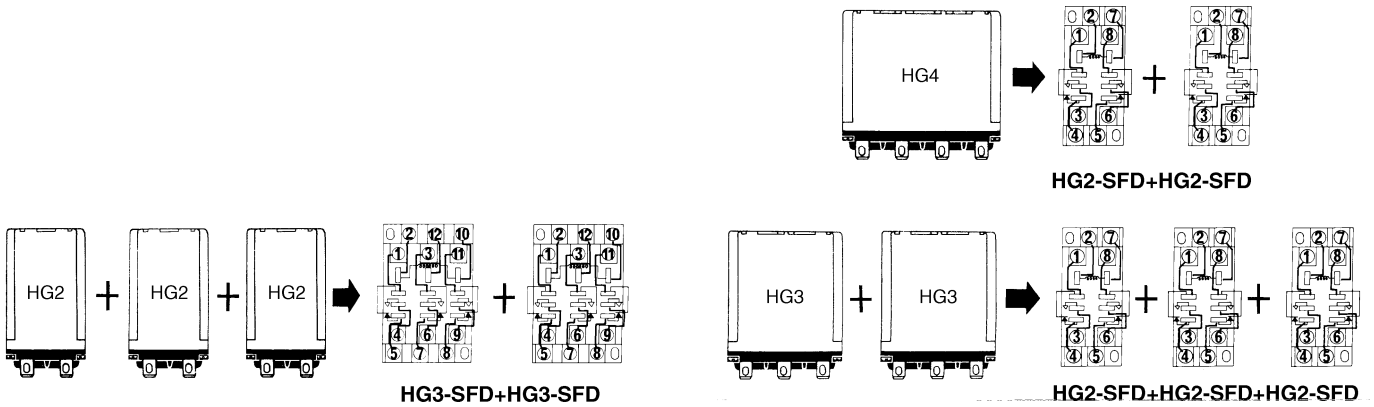

NOTES

Please use the hold-down clip whenever HG relays will be used in applications where strong vibrating or shock force occurs. When used in such applications,

mount the relay so that this force does not parallel the direction of contact movement.

For Cautions for Use, see Relay Technical Information