

阅读申明

- 1.本站收集的数据手册和产品资料都来自互联网，版权归原作者所有。如读者和版权方有任何异议请及时告之，我们将妥善解决。
- 2.本站提供的中文数据手册是英文数据手册的中文翻译，其目的是协助用户阅读，该译文无法自动跟随原稿更新，同时也可能存在翻译上的不当。建议读者以英文原稿为参考以便获得更精准的信息。
- 3.本站提供的产品资料，来自厂商的技术支持或者使用者的心得体会等，其内容可能存在描述上的差异，建议读者做出适当判断。
- 4.如需与我们联系，请发邮件到marketing@iczoom.com，主题请标有“数据手册”字样。

Read Statement

1. The datasheets and other product information on the site are all from network reference or other public materials, and the copyright belongs to the original author and original published source. If readers and copyright owners have any objections, please contact us and we will deal with it in a timely manner.
2. The Chinese datasheets provided on the website is a Chinese translation of the English datasheets. Its purpose is for reader's learning exchange only and do not involve commercial purposes. The translation cannot be automatically updated with the original manuscript, and there may also be improper translations. Readers are advised to use the English manuscript as a reference for more accurate information.
3. All product information provided on the website refer to solutions from manufacturers' technical support or users the contents may have differences in description, and readers are advised to take the original article as the standard.
4. If you have any questions, please contact us at marketing@iczoom.com and mark the subject with "Datasheets" .

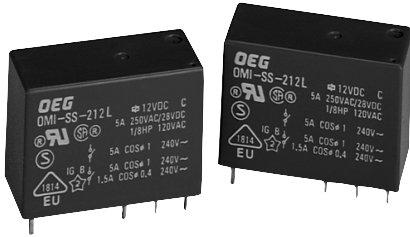

OMI 2 Pole series

2 Pole Miniature Power PC Board Relay

Appliances, HVAC, Office Machines.

UL File No. E58304

CSA File No. LR48471

VDE File No. 6678

SEMKO File No. 9517235

Users should thoroughly review the technical data before selecting a product part number. It is recommended that user also seek out the pertinent approvals files of the agencies/laboratories and review them to ensure the product meets the requirements for a given application.

Features

- Meet UL 508, VDE0435 and SEMKO requirements.
- 2 Form A and 2 Form C contact arrangements.
- Immersion cleanable, sealed version available.
- Meet 5,000V dielectric voltage between coil and contacts.
- Meet 10,000V surge voltage between coil and contacts (1.2 / 50µs).

Contact Data @ 20°C

Arrangements: 2 Form A (DPST-NO) and 2 Form C (DPDT).

Material: Ag Alloy.

Max. Switching Rate: 300 ops./min. (no load).
30 ops./min. (rated load).

Expected Mechanical Life: 10 million operations (no load).

Expected Electrical Life: 100,000 operations (rated load).

Minimum Load: 100mA @ 5VDC.

Initial Contact Resistance: 100 milliohms @ 1A, 6VDC.

Contact Ratings

Ratings: 5A @ 240VAC resistive,
5A @ 120VAC resistive,
5A @ 30VDC resistive,
1/8 HP @ 250VAC.

1.5A @ 240VAC inductive (cosφ = 0.4),
1.5A @ 120VAC inductive (cosφ = 0.4),
1.5A @ 24VDC inductive (L/R=7msec).

Max. Switched Voltage: AC: 240V.
DC: 30V.

Max. Switched Current: 5A.

Max. Switched Power: OMI: 1,200VA, 150W.

Initial Dielectric Strength

Between Open Contacts: 1,000VAC 50/60 Hz. (1 minute).

Between Coil and Contacts: 5,000VAC 50/60 Hz. (1 minute).

Surge Voltage Between Coil and Contacts: 10,000V (1.2 / 50µs).

Initial Insulation Resistance

Between Mutually Insulated Elements: 1,000M ohms min. @ 500VDCM.

Coil Data

Voltage: 5 to 48VDC.

Nominal Power: 720mW (OMI-D), 540mW (OMI-L).

Coil Temperature Rise: 45°C max., at rated coil voltage.

Max. Coil Power: 130% of nominal.

Duty Cycle: Continuous.

Coil Data @ 20°C

OMI-L Sensitive				
Rated Coil Voltage (VDC)	Nominal Current (mA)	Coil Resistance (ohms) ± 10%	Must Operate Voltage (VDC)	Must Release Voltage (VDC)
5	106.4	47	4.00	0.50
6	88.0	68	4.80	0.60
9	58.0	155	7.20	0.90
12	44.4	270	9.60	1.20
24	21.8	1,100	19.20	2.40
48	10.9	4,400	38.40	4.80
OMI-D Standard				
Rated Coil Voltage (VDC)	Nominal Current (mA)	Coil Resistance (ohms) ± 10%	Must Operate Voltage (VDC)	Must Release Voltage (VDC)
5	138.9	36	3.75	0.50
6	120.0	50	4.50	0.60
9	78.3	115	6.75	0.90
12	60.0	200	9.00	1.20
24	29.3	820	18.00	2.40
48	14.5	3,300	36.00	4.80

Operate Data

Must Operate Voltage:

OMI-D: 75% of nominal voltage or less.

OMI-L: 80% of nominal voltage or less.

Must Release Voltage: 5% of nominal voltage or more.

Operate Time: OMI-D: 15 ms max.

OMI-L: 20 ms max.

Release Time: 8 ms max.

Environmental Data

Temperature Range:

Operating: OMI-D:
-30°C to +55°C

OMI-L:
-30°C to +70 °C

Vibration, Mechanical: 10 to 55 Hz., 1.5mm double amplitude

Operational: 10 to 55 Hz., 1.5mm double amplitude.

Shock, Mechanical: 1,000m/s² (10G approximately).

Operational: 100m/s² (10G approximately).

Operating Humidity: 20 to 85% RH. (Non-condensing).

Mechanical Data

Termination: Printed circuit terminals.

Enclosure (94V-0 Flammability Ratings):

OMI-SS: Vented (Flux-tight) plastic cover.

OMI-SH: Sealed plastic case.

Weight: 0.46 oz (13g) approximately.

Ordering Information

Typical Part Number ▶ **OMI -SS -2 12 L M ,594**

1. Basic Series: OMI = 2 Pole Miniature Power PC Board Relay.		
2. Enclosure: SS = Vent (Flux-tight)* plastic cover. SH = Sealed, plastic case.		
3. Termination: 2 = 2 pole		
4. Coil Voltage: 05 = 5VDC 09 = 9VDC 24 = 24VDC 06 = 6VDC 12 = 12VDC 48 = 48VDC		
5. Coil Input: D = Standard (720mW) L = Sensitive (540mW)		
6. Contact Arrangement: Blank = 2 Form C, DPDT M = 2 Form A, DPST-NO		
7. Suffix: ,500 = Standard model for "SS" enclosure ,594 = Standard model for "SH" enclosure Other Suffix = Custom model		

* Not suitable for immersion cleaning processes.

Our authorized distributors are more likely to stock the following items for immediate delivery.

- OMI-SH-205D,594 OMI-SH-205L,594
- OMI-SH-212D,594 OMI-SH-212L,594
- OMI-SH-224D,594 OMI-SH-224L,594

Outline Dimensions

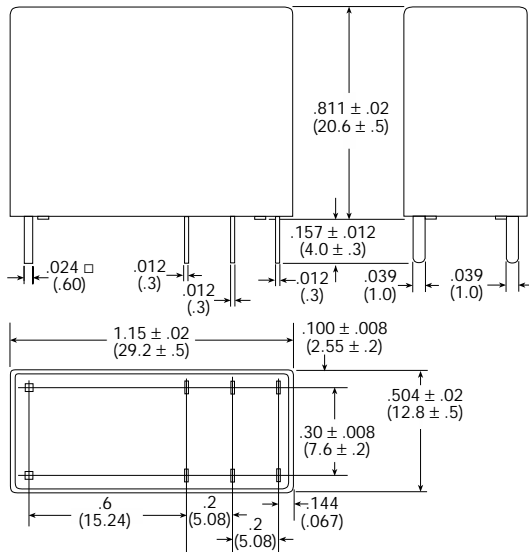

Wiring Diagram (Bottom View)

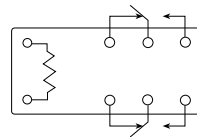

PC Board Layout (Bottom View)

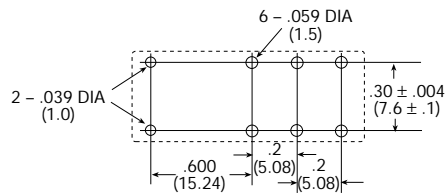

Reference Data

Coil Temperature Rise

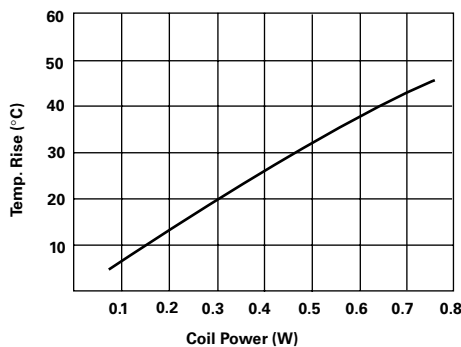

Operate Time

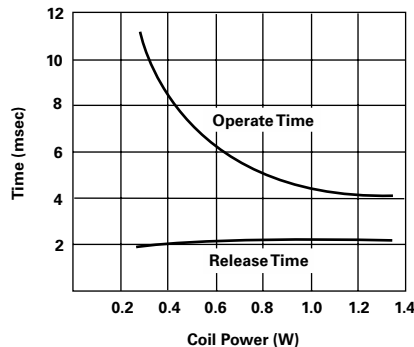

Life Expectancy

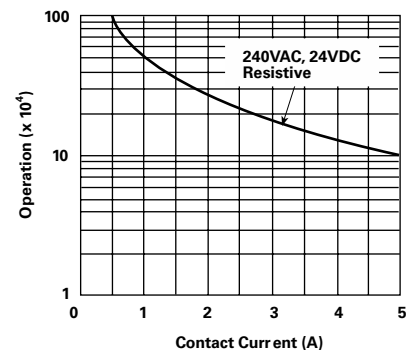

Dimensions are shown for reference purposes only.

Dimensions are in inches over (millimeters) unless otherwise specified.

Specifications and availability subject to change.

www.tycoelectronics.com
Technical support:
Refer to inside back cover.