

## 阅读申明

- 1.本站收集的数据手册和产品资料都来自互联网，版权归原作者所有。如读者和版权方有任何异议请及时告之，我们将妥善解决。
- 2.本站提供的中文数据手册是英文数据手册的中文翻译，其目的是协助用户阅读，该译文无法自动跟随原稿更新，同时也可能存在翻译上的不当。建议读者以英文原稿为参考以便获得更精准的信息。
- 3.本站提供的产品资料，来自厂商的技术支持或者使用者的心得体会等，其内容可能存在描述上的差异，建议读者做出适当判断。
- 4.如需与我们联系，请发邮件到marketing@iczoom.com，主题请标有“数据手册”字样。

## Read Statement

1. The datasheets and other product information on the site are all from network reference or other public materials, and the copyright belongs to the original author and original published source. If readers and copyright owners have any objections, please contact us and we will deal with it in a timely manner.
2. The Chinese datasheets provided on the website is a Chinese translation of the English datasheets. Its purpose is for reader's learning exchange only and do not involve commercial purposes. The translation cannot be automatically updated with the original manuscript, and there may also be improper translations. Readers are advised to use the English manuscript as a reference for more accurate information.
3. All product information provided on the website refer to solutions from manufacturers' technical support or users the contents may have differences in description, and readers are advised to take the original article as the standard.
4. If you have any questions, please contact us at marketing@iczoom.com and mark the subject with "Datasheets" .

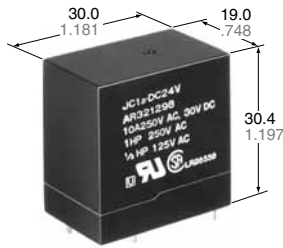

PC board type

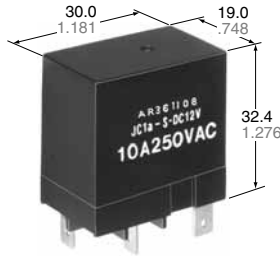

Plug-in type

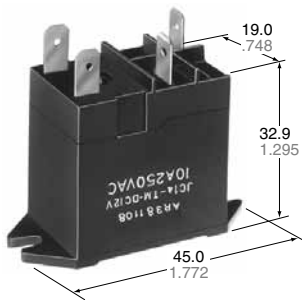

TM type

mm inch

## FEATURES

- **High inrush current capability**  
1 Form A: 163 A inrush (TV-8)  
2 Form A: 111 A inrush (TV-5)
- **High dielectric withstanding for transient protection:**  
JC can withstand 10,000 V surge in  $\mu$ s between coil and contact.
- **Electrical life:**  
1 Form A:  $10^5$  ope. at 15 A 250 V AC resistive load  
2 Form A:  $10^5$  ope. at 10 A 250 V AC resistive load
- **UL/CSA, VDE, TÜV, SEMKO also approved.**

## COMMENTS ABOUT Cd FREE

We have introduced Cadmium free type products to reduce the material which is not good for our environment. (The suffix "F" should be added to the part number.) If you are still using Cadmium containing parts, which don't have "F" on the suffix of the part number, please use Cadmium free parts from now on. The life of the Cadmium free parts may be shorter than the Cadmium containing parts based on the load condition, so please evaluate the Cadmium free parts with your actual application before use.

RoHS Directive compatibility information  
<http://www.nais-e.com/>

## SPECIFICATIONS

### Contact

Arrangement		1 Form A	2 Form A
Initial contact resistance, max. (By voltage drop 6 V DC 1 A)		30 m $\Omega$	
Contact material		AgSnO <sub>2</sub> type	
Contact force, min.		30 g	
Rating (resistive load)	Maximum switching power	3,750 VA	2,500 VA
	Maximum switching voltage	250 V AC	250 V AC
	Max. switching current	15 A	10 A
	Min. switching capacity <sup>#1</sup>	100 mA, 5 V DC	
Expected life (min. operation)	Mechanical	$5 \times 10^6$	
	Electrical (resistive)	10 A 250 V AC	$10^5$
		5A 250 V AC	—

### Coil

Nominal operating power	900 mW	1,000 mW
-------------------------	--------	----------

<sup>#1</sup> This value can change due to the switching frequency, environmental conditions, and desired reliability level, therefore it is recommended to check this with the actual load.

### Remarks

- \* Specifications will vary with foreign standards certification ratings.
- <sup>#1</sup> Measurement of same location as "Initial breakdown voltage" section
- <sup>#2</sup> Detection current: 10mA
- <sup>#3</sup> Excluding contact bounce time
- <sup>#4</sup> Half-wave pulse of sine wave: 11ms; detection time: 10 $\mu$ s
- <sup>#5</sup> Half-wave pulse of sine wave: 6ms
- <sup>#6</sup> Detection time: 10 $\mu$ s
- <sup>#7</sup> Refer to 6. Conditions for operation, transport and storage mentioned in AMBIENT ENVIRONMENT

### Characteristics

Maximum operating speed	20 cpm.	
Initial insulation resistance <sup>*1</sup>	Min. 100 M $\Omega$ at 500 V DC	
Initial breakdown voltage <sup>*2</sup>	Between open contacts	2,000 V rms for 1 min.
	Between contacts sets	2,000 Vrms for 1 min.
	Between contacts and coil	4,000 Vrms for 1 min.
Operate time <sup>*3</sup> (at nominal voltage)	Max. 30 ms	
Release time(without diode) <sup>*3</sup> (at nominal voltage)	Max. 10 ms	
Temperature rise (at nominal voltage)	Max. 55°C	
Shock resistance	Functional <sup>*4</sup>	196 m/s <sup>2</sup> {20 G}
	Destructive <sup>*5</sup>	980 m/s <sup>2</sup> {100 G}
Vibration resistance	Functional <sup>*6</sup>	98 m/s <sup>2</sup> {10 G}, 10 to 55 Hz at double amplitude of 1.6 mm
	Destructive	117.6 m/s <sup>2</sup> {12 G}, 10 to 55 Hz at double amplitude of 2 mm
Conditions for operation, transport and storage <sup>*7</sup> (Not freezing and condensing at low temperature)	Ambient temp.	-50°C to +60°C -58°F to +140°F
	Humidity	5 to 85%R.H.
Unit weight	Approx. 31 g 1.09 oz	

**TYPICAL APPLICATIONS**

- Automatic garage door openers
- Microwave ovens
- Dryers
- Vending machines
- Copiers
- Air conditioners
- Stereo equipment
- TV sets

**ORDERING INFORMATION**

Ex. JC 1a F — TM — DC12V — F

Contact arrangement	Mounting classification	Coil voltage	Contact material
1a: 1 Form A 2a: 2 Form A	Nil: PC board terminal S: Plug-in terminal TM: Top mounting	DC 5, 6, 12, 24, 48 V	F: AgSnO <sub>2</sub> type

- (Notes) 1. TV rated types available 1 Form A: TV-8; 2 Form A: TV-5.  
 2. Standard packing. Carton: 50 pcs.; Case: 200 pcs.  
 3. UL/CSA, VDE, TÜV, and SEMKO certified products can also be supported. Please consult us.  
 4. Please inquire about the previous products (Cadmium containing parts).

**COIL DATA (at 20°C 68°F)**

Contact arrangement	Nominal voltage. V DC	Pick-up voltage. V DC (max.)	Drop-out voltage. V DC (min.)	Coil resistance, Ω(±10%)	Nominal operating current, mA	Nominal operating power, W	Maximum allowable voltage, V DC (at 60°C)
1 Form A	6	4.8	0.6	40	150	0.9	6.6
	12	9.6	1.2	160	75	0.9	13.2
	24	19.2	2.4	640	37.5	0.9	26.4
	48	38.4	4.8	2,560	18.8	0.9	52.8
2 Form A	6	4.8	0.6	36	166.6	1.0	6.6
	12	9.6	1.2	144	83.3	1.0	13.2
	24	19.2	2.4	576	41.6	1.0	26.4
	48	38.4	4.8	2,304	20.8	1.0	52.8

**DIMENSIONS**

mm inch

**PC board type JC1a**

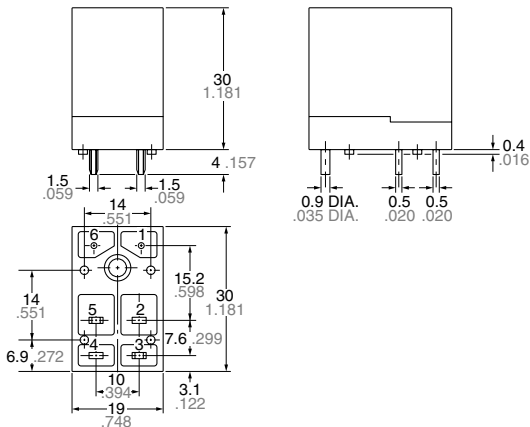

**Schematic**

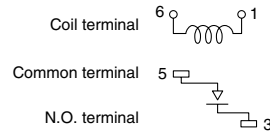

**PC board pattern (Bottom view)**

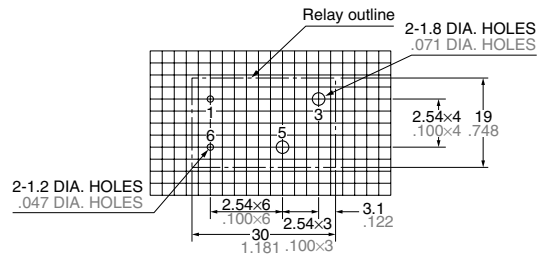

**PC board type JC2a**

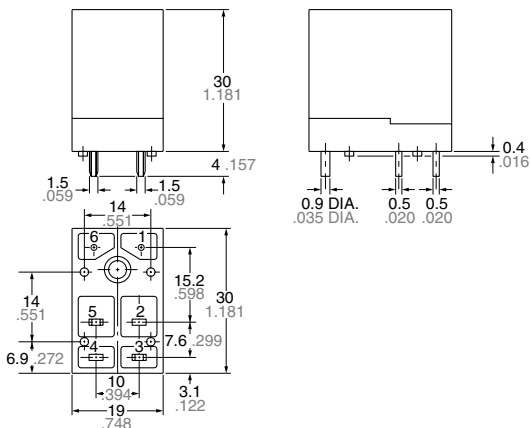

**Schematic**

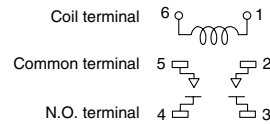

**PC board pattern (Bottom view)**

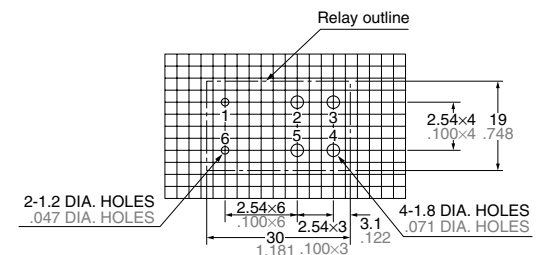

General tolerance: ±0.3 ±0.12

Tolerance: ±0.1 ±0.04

Top mount type

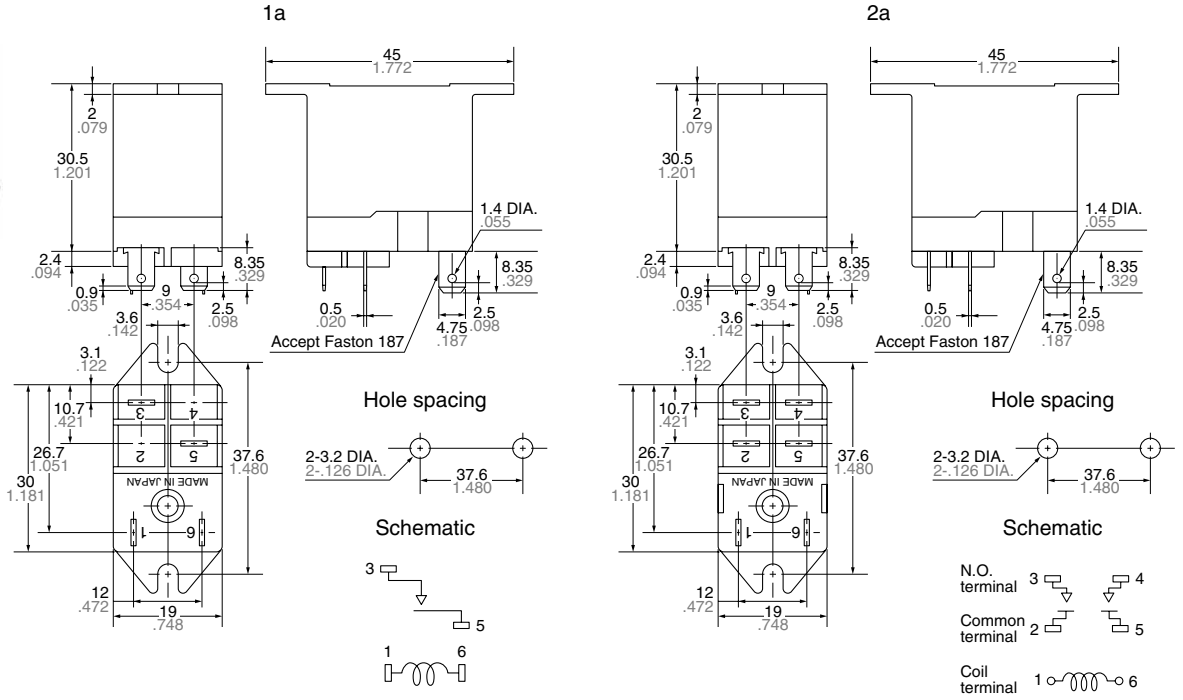

Plug-in type

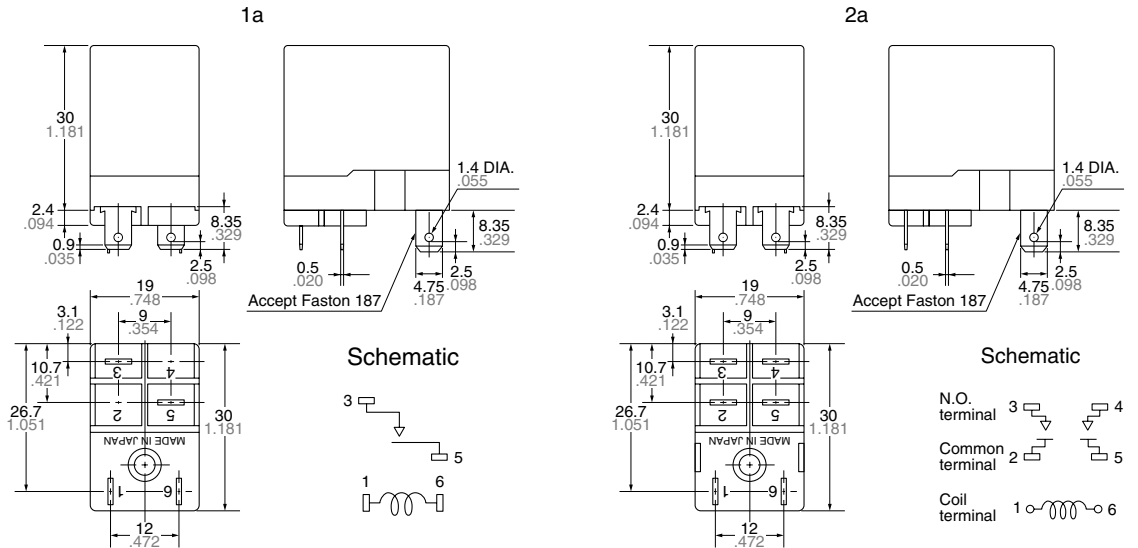

General tolerance:  $\pm 0.3 \pm .012$

REFERENCE DATA

JC1a type

1. Maximum value for switching capacity

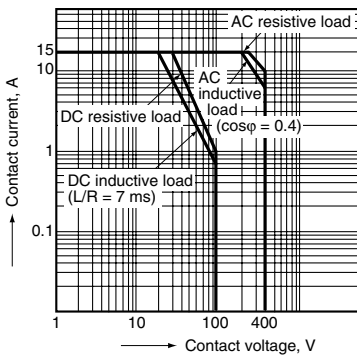

2. Life curve

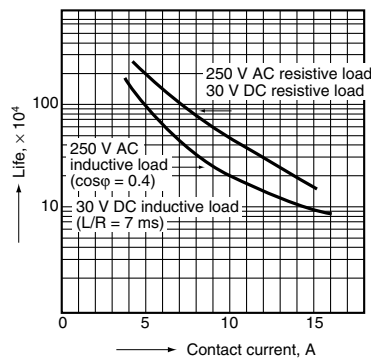

3.-(1) Coil temperature rise

Point measured: Inside the coil  
Ambient temperature: 26°C 79°F

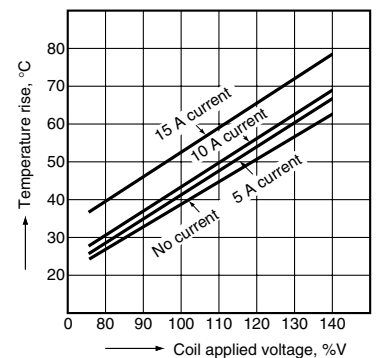

3.-(2) Coil temperature rise

Point measured: Inside the coil  
Ambient temperature: 40°C 104°F

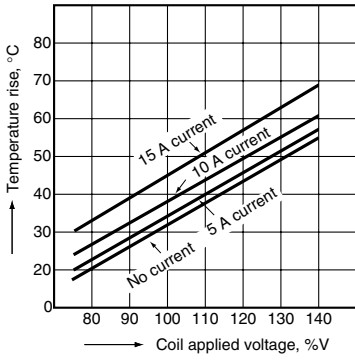

3.-(3) Coil temperature rise

Point measured: Inside the coil  
Ambient temperature: 60°C 140°F

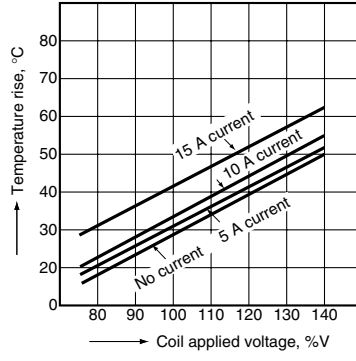

4. Operate / release time

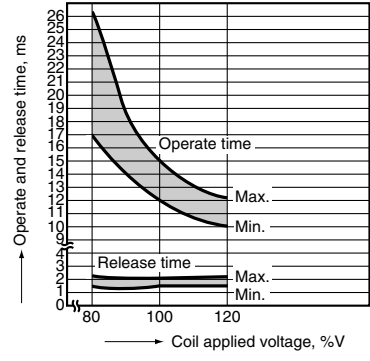

JC2a type

1. Maximum value for switching capacity

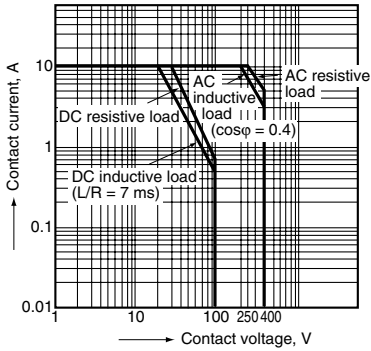

2. Life curve

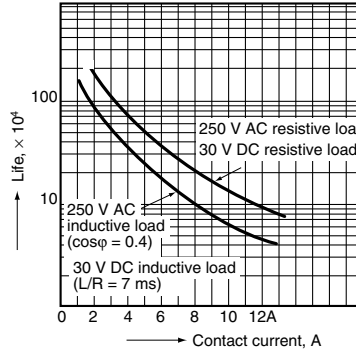

3.-(1) Coil temperature rise

Point measured: Inside the coil  
Ambient temperature: 26°C 79°F

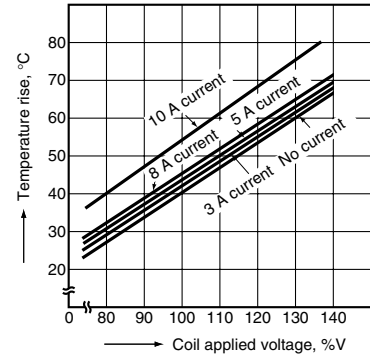

3.-(2) Coil temperature rise

Point measured: Inside the coil  
Ambient temperature: 40°C 104°F

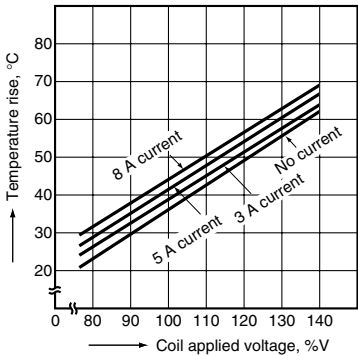

3.-(3) Coil temperature rise

Point measured: Inside the coil  
Ambient temperature: 60°C 140°F

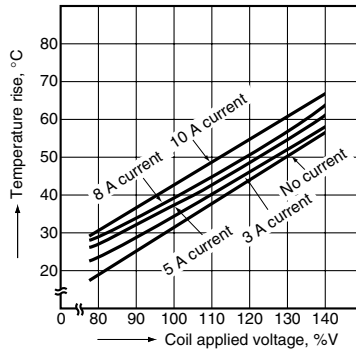

4. Operate / release time

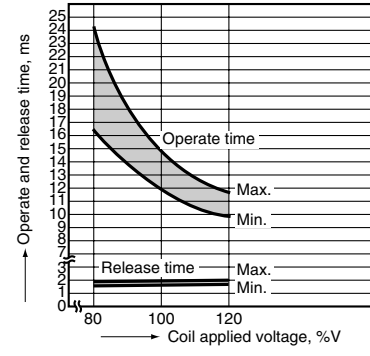

**ACCESSORIES**



JC1-SS



JC2-SS



JC1-PS



JC2-PS

JC2-SS

JC2-PS

mm inch

Tolerance:  $\pm 0.5 \pm .020$

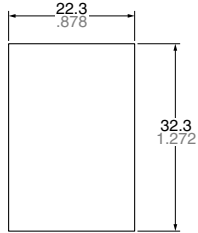
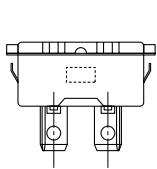
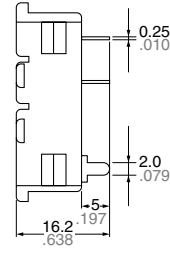
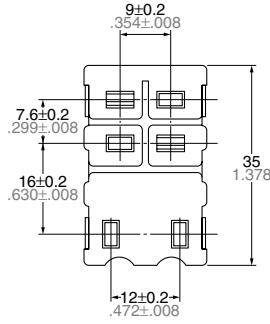
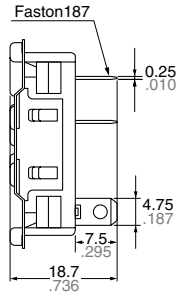
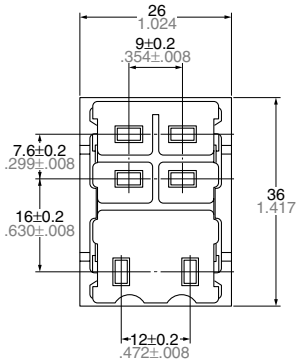

Panel cutout  
Tolerance:  $\pm 0.1 \pm .004$

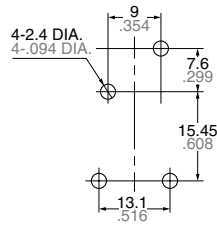
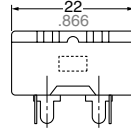

JC1-PS

PC board Pattern

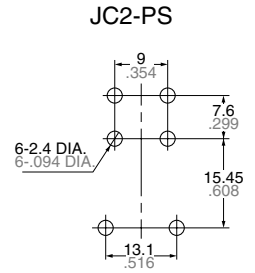

JC2-PS

Tolerance:  $\pm 0.1 \pm .004$

(Note)

Outward dimensions and chassis cutout dimensions for JC1-SS and JC1-PS are same as those of JC2-SS and JC2-PS respectively.  
UL/CSA approved type is standard.

**For Cautions for Use, see Relay Technical Information**