

阅读申明

- 1.本站收集的数据手册和产品资料都来自互联网，版权归原作者所有。如读者和版权方有任何异议请及时告之，我们将妥善解决。
- 2.本站提供的中文数据手册是英文数据手册的中文翻译，其目的是协助用户阅读，该译文无法自动跟随原稿更新，同时也可能存在翻译上的不当。建议读者以英文原稿为参考以便获得更精准的信息。
- 3.本站提供的产品资料，来自厂商的技术支持或者使用者的心得体会等，其内容可能存在描述上的差异，建议读者做出适当判断。
- 4.如需与我们联系，请发邮件到marketing@iczoom.com，主题请标有“数据手册”字样。

Read Statement

1. The datasheets and other product information on the site are all from network reference or other public materials, and the copyright belongs to the original author and original published source. If readers and copyright owners have any objections, please contact us and we will deal with it in a timely manner.
2. The Chinese datasheets provided on the website is a Chinese translation of the English datasheets. Its purpose is for reader's learning exchange only and do not involve commercial purposes. The translation cannot be automatically updated with the original manuscript, and there may also be improper translations. Readers are advised to use the English manuscript as a reference for more accurate information.
3. All product information provided on the website refer to solutions from manufacturers' technical support or users the contents may have differences in description, and readers are advised to take the original article as the standard.
4. If you have any questions, please contact us at marketing@iczoom.com and mark the subject with "Datasheets" .

Panasonic
ideas for life

10 AMP POWER RELAY

HP RELAYS

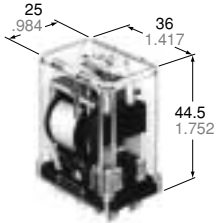

mm inch

FEATURES

- Interchangeable with existing models
- Long life and high reliability
- High contact capacity up to 10 A 250 V AC
- Available with plug-in/solder and quick-connect terminals

SPECIFICATIONS (at 20°C 68°F)

Contacts

Arrangement		2 Form C	3 Form C	4 Form C
Initial contact resistance, max. (By voltage drop 6 V DC 1 A)		15 mΩ		
Contact material		Silver		Silver alloy
Rating	Nominal switching capacity	10 A 250 V AC (resistive)		
	Min. switching capacity ^{#1}	100 mA, 5 V DC		

#1 This value can change due to the switching frequency, environmental conditions, and desired reliability level, therefore it is recommended to check this with the actual load.

Remarks

- * Specifications will vary with foreign standards certification ratings.
- *1 Measurement at same location as "initial breakdown voltage" section
- *2 Detection current; 10 mA
- *3 Excluding contact bounce time
- *4 Half-wave pulse of sine wave: 11ms; detection time: 10μs
- *5 Half-wave pulse of sine wave: 6ms
- *6 Detection time: 10μs
- *7 Refer to 6. Conditions for operation, transport and storage mentioned in AMBIENT ENVIRONMENT

Characteristics (at 60 Hz, 20°C 68°F)

		2 Form C	3 Form C	4 Form C
Maximum operating speed		20 cpm		
Initial insulation resistance ^{*1}		more than 100 MΩ at 500 V DC		
Breakdown voltage ^{*2}	Between open contacts	1,000 Vrms	2,000 Vrms	1,000 Vrms
	Between contact sets	1,500 Vrms	2,000 Vrms	1,500 Vrms
	Between contact and coil	1,500 Vrms	2,000 Vrms	1,500 Vrms
Operate time ^{*3} (at nominal voltage)		Max. 25 ms	Max. 30 ms	
Release time (without diode) ^{*3} (at nominal voltage)		Max. 25 ms	Max. 30 ms	
Temperature rise		Max. 65°C		
Shock resistance	Functional ^{*4}	98 m/s ² {10 G}		
	Destructive ^{*5}	980 m/s ² {100 G}		
Vibration resistance	Functional ^{*6}	10 to 55 Hz at 1 mm double amplitude		
	Destructive	10 to 55 Hz at 2 mm double amplitude		
Conditions for operation, transport and storage ^{*7} (Not freezing and condensing at low temperature)	Ambient temp.	-50°C to +40°C -58°F to +104°F		
	Humidity	5 to 85% R.H.		
Unit weight		Approx. 60g 2.12 oz	Approx. 100g 3.53 oz	Approx. 125g 4.41 oz

LIFE DATA

Contact rating and expected life For AC load type

	Voltage	125 V AC		250 V AC		Expected life (min. operations)
		Resistive (cos φ ≅ 1)	Inductive (cos φ ≅ 0.4)	Resistive (cos φ ≅ 1)	Inductive (cos φ ≅ 0.4)	
Electrical life	Load	—	—	10 A	7.5 A	2×10 ⁵
		10 A	7.5 A	7.5 A	5 A	5×10 ⁵
		5 A	3 A	3 A	2 A	1×10 ⁶
		1A	0.7 A	0.6 A	0.4 A	2×10 ⁶
Mechanical life						1×10 ⁷

Note: When the electromagnet or exciting coil (Solenoid, etc.) is the load, the value of motor or lamp load is applicable.

Contact rating and expected life For DC load type

	Voltage	24 V DC		125 V DC		Expected life (min. operations)
		Resistive (cos φ ≅ 1)	Inductive (cos φ ≅ 0.4)	Resistive (cos φ ≅ 1)	Inductive (cos φ ≅ 0.4)	
Electrical life	Current	—	7 A	—	—	2×10 ⁵
		7.5 A	5 A	0.5 A	0.4 A	5×10 ⁵
		5 A	3 A	0.3 A	0.2 A	1×10 ⁶
		1A	0.6 A	0.1 A	0.06 A	2×10 ⁶
Mechanical life						1×10 ⁷

Life curve

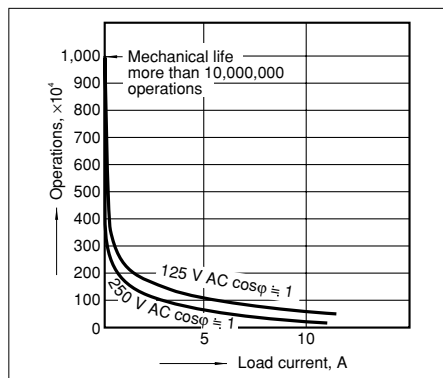

Notes:

1. For DC inductive loads, use an arc suppressing circuit.
2. When used under a DC load operating at high repetition rate with considerable arcing, corrosion of the contacts and/or the contact blades is likely to occur. When using the relay under conditions of high temperature, humidity or high repetition rate, it is suggested that the relay cover be removed to facilitate extended operation.

TYPICAL APPLICATIONS

HP relays enjoy wide use in various applications, particularly in automation controls and remote controls.

Applications include:
Industrial machinery

Machine tool
Food processing packing machines
Office equipment
Coin operate devices
Home appliances

Transportation
Communication and measuring devices
Amusement devices

ORDERING INFORMATION

Ex. HP 3 — M — AC240V

Contact arrangement	Terminal	Coil voltage
2: 2 Form C 3: 3 Form C 4: 4 Form C	Nil: Standard plug-in terminal M: Direct mounting (3 Form C only) TM: Top mounting (2 Form C only) L: Lamp wired, standard plug-in terminal	AC 6, 12, 24, 48, 115, 220, 240 V DC 6, 12, 24, 48, 110 V

- (Notes) 1. For UL/CSA or VDE recognized types, add suffix UL/CSA or VDE (HP2-TM type VDE application under way)
2. Standard packing Carton: 50 pcs. Case: 200 pcs.
3. UL/CSA approved type is standard.

TYPES AND COIL DATA

1. Standard plug-in terminal type (without lamp wired)

DC TYPES at 20°C 68°F

Type	Part No.	Nominal coil voltage, V DC	Pick-up voltage, V DC (max.)	Drop-out voltage, V DC (min.)	Max. allowable voltage, V DC	Coil resistance, Ω (±10%)	Nominal coil current, mA	Nominal operating power, W
2 Form C	HP2-DC6V	6	4.8	0.9	6.6	25	240	1.5
	HP2-DC12V	12	9.6	1.8	13.2	110	109	1.3
	HP2-DC24V	24	19.2	3.6	26.4	440	54.5	1.3
	HP2-DC48V	48	38.4	7.2	52.8	1,800	26.7	1.3
	HP2-DC110V	110	88	16.5	121	7,300	15.0	1.7
3 Form C	HP3-DC6V	6	4.8	0.9	6.6	24	250	1.5
	HP3-DC12V	12	9.6	1.8	13.2	100	120	1.4
	HP3-DC24V	24	19.2	3.6	26.4	400	60	1.4
	HP3-DC48V	48	38.4	7.2	52.8	1,560	31	1.5
	HP3-DC110V	110	88	16.5	121	7,450	14.9	1.6
4 Form C	HP4-DC6V	6	4.8	0.9	6.6	22	273	1.6
	HP4-DC12V	12	9.6	1.8	13.2	95	127	1.5
	HP4-DC24V	24	19.2	3.6	26.4	380	63	1.5
	HP4-DC48V	48	38.4	7.2	52.8	1,500	32	1.5
	HP4-DC110V	110	88	16.5	121	7,000	15.7	1.7

AC TYPE (50/60 Hz) at 60 Hz, 20°C 68°F

Type	Part No.	Nominal coil voltage, V AC	Pick-up voltage, V AC (max.)	Drop-out voltage, V AC (min.)	Max. allowable voltage, V AC	Inductance, H	Nominal coil current, mA	Nominal operating power, VA
2 Form C	HP2-AC6V	6	4.8	1.8	6.6	0.049	310	1.9
	HP2-AC12V	12	9.6	3.6	13.2	0.190	160	1.9
	HP2-AC24V	24	19.2	7.2	26.4	0.776	78	1.9
	HP2-AC48V	48	38.4	14.4	52.8	3.106	39	1.9
	HP2-AC115V	115	92	34.5	126.5	15.83	18	2.1
	HP2-AC220V	220	176	66	242	57.90	9.5	2.1
	HP2-AC240V	240	192	72	264	66.26	9.0	2.2
3 Form C	HP3-AC6V	6	4.8	1.8	6.6	0.030	520	3.1
	HP3-AC12V	12	9.6	3.6	13.2	0.119	260	3.1
	HP3-AC24V	24	19.2	7.2	26.4	0.475	130	3.1
	HP3-AC48V	48	38.4	14.4	52.8	1.899	65	3.1
	HP3-AC115V	115	92	34.5	126.5	10.36	28.5	3.3
	HP3-AC220V	220	176	66	242	39.32	14.2	3.1
	HP3-AC240V	240	192	72	264	44.05	13.9	3.3
4 Form C	HP4-AC6V	6	4.8	1.8	6.6	0.019	800	4.8
	HP4-AC12V	12	9.6	3.6	13.2	0.077	400	4.8
	HP4-AC24V	24	19.2	7.2	26.4	0.309	200	4.8
	HP4-AC48V	48	38.4	14.4	52.8	1.292	95	4.6
	HP4-AC115V	115	92	34.5	126.5	6.953	42	4.8
	HP4-AC220V	220	176	66	242	26.57	21	4.6
	HP4-AC240V	240	192	72	264	29.75	20.5	4.9

NOTES

- The range of coil current for AC relays is $\pm 15\%$ (60 Hz). For DC relays it is $\pm 10\%$ at 20°C, 68°F.
- The HP relay will operate in a range from 80% to 110% of the nominal coil voltage. It is, however, recommended that the relay be used in the range of 85% to 110% of the nominal coil voltage, with the temporary voltage variation taken into consideration.
- When the operating voltage of AC relays drops below 80% of the nominal coil voltage, the relay will generate a considerable amount of heat which is not recommended for maximum efficiency.
- The coil resistance of DC types is the measured value of the coil at a temperature of 20°C 68°F. If the coil temperature changes by $\pm 1^\circ\text{C}$, the measured value of the coil resistance should be increased or decreased by 0.4%.
- For applications from 220 V to 240 V DC, connect a resistor in series with the relay coil. See chart for resistor values.

Voltage	2 Form C	3 Form C	4 Form C
220 V DC	7.3 k Ω (5 W)	7.45 k Ω (5 W)	7 k Ω (5 W)
240 V DC	8.7 k Ω (5 W)	8.8 k Ω (5 W)	8.3 k Ω (5 W)

2. Standard plug-in terminal type (with lamp wired)

DC TYPES at 20°C 68°F

Type	Part No.	Nominal coil voltage, V DC	Pick-up voltage, V DC (max.)	Drop-out voltage, V DC (min.)	Max. allowable voltage, V DC	Coil resistance, Ω ($\pm 10\%$)	Nominal coil current, mA	Nominal operating power, W	
2 Form C	LED	HP2-L-DC6V	6	4.8	0.9	6.6	25	240	1.5
		HP2-L-DC12V	12	9.6	1.8	13.2	110	109	1.3
		HP2-L-DC24V	24	19.2	3.6	26.4	440	54.5	1.3
		HP2-L-DC48V	48	38.4	7.2	52.8	1,800	26.7	1.3
	Neon lamp	HP2-L-DC110V	110	88	16.5	121	7,300	15.0	1.7
3 Form C	LED	HP3-L-DC6V	6	4.8	0.9	6.6	24	250	1.5
		HP3-L-DC12V	12	9.6	1.8	13.2	100	120	1.4
		HP3-L-DC24V	24	19.2	3.6	26.4	400	60	1.4
		HP3-L-DC48V	48	38.4	7.2	52.8	1,560	31	1.5
	Neon lamp	HP3-L-DC110V	110	88	16.5	121	7,450	14.9	1.6
4 Form C	LED	HP4-L-DC6V	6	4.8	0.9	6.6	22	273	1.6
		HP4-L-DC12V	12	9.6	1.8	13.2	95	127	1.5
		HP4-L-DC24V	24	19.2	3.6	26.4	380	63	1.5
		HP4-L-DC48V	48	38.4	7.2	52.8	1,500	32	1.5
	Neon lamp	HP4-L-DC110V	110	88	16.5	121	7,000	15.7	1.7

AC TYPE (50/60 Hz) at 60 Hz, 20°C 68°F

Type		Part No.	Nominal coil voltage, V AC	Pick-up voltage, V AC (max.)	Drop-out voltage, V AC (min.)	Max. allowable voltage, V AC	Inductance, H	Nominal coil current, mA	Nominal operating power, VA
2 Form C	LED	HP2-L-AC6V	6	4.8	1.8	6.6	0.049	310	1.9
		HP2-L-AC12V	12	9.6	3.6	13.2	0.190	160	1.9
		HP2-L-AC24V	24	19.2	7.2	26.4	0.776	78	1.9
	Neon lamp	HP2-L-AC115V	115	92	34.5	126.5	15.83	18	2.1
		HP2-L-AC220V	220	176	66	242	57.90	9.5	2.1
		HP2-L-AC240V	240	192	72	264	66.26	9.0	2.2
3 Form C	LED	HP3-L-AC6V	6	4.8	1.8	6.6	0.030	520	3.1
		HP3-L-AC12V	12	9.6	3.6	13.2	0.119	260	3.1
		HP3-L-AC24V	24	19.2	7.2	26.4	0.475	130	3.1
	Neon lamp	HP3-L-AC115V	115	92	34.5	126.5	10.36	28.5	3.3
		HP3-L-AC220V	220	176	66	242	39.32	14.2	3.1
		HP3-L-AC240V	240	192	72	264	44.05	13.9	3.3
4 Form C	LED	HP4-L-AC6V	6	4.8	1.8	6.6	0.019	800	4.8
		HP4-L-AC12V	12	9.6	3.6	13.2	0.077	400	4.8
		HP4-L-AC24V	24	19.2	7.2	26.4	0.309	200	4.8
	Neon lamp	HP4-L-AC115V	115	92	34.5	126.5	6.953	42	4.8
		HP4-L-AC220V	220	176	66	242	26.57	21	4.6
		HP4-L-AC240V	240	192	72	264	29.75	20.5	4.9

3. Top Mounting (TM) and direct mounting (M) type

DC TYPES at 20°C 68°F

Type		Part No.	Nominal coil voltage, V DC	Pick-up voltage, V DC (max.)	Drop-out voltage, V DC (min.)	Max. allowable voltage, V DC	Coil resistance, Ω (±10%)	Nominal coil current, mA	Nominal operating power, W
2 Form C Top Mounting Type (TM)		HP2-TM-DC6V	6	4.8	0.9	6.6	25	240	1.5
		HP2-TM-DC12V	12	9.6	1.8	13.2	110	109	1.3
		HP2-TM-DC24V	24	19.2	3.6	26.4	440	54.5	1.3
		HP2-TM-DC48V	48	38.4	7.2	52.8	1,800	26.7	1.3
		HP2-TM-DC110V	110	88	16.5	121	7,300	15.0	1.7
3 Form C Direct Mounting Type (TM)		HP3-M-DC6V	6	4.8	0.9	6.6	24	250	1.5
		HP3-M-DC12V	12	9.6	1.8	13.2	100	120	1.4
		HP3-M-DC24V	24	19.2	3.6	26.4	400	60	1.4
		HP3-M-DC48V	48	38.4	7.2	52.8	1\$B!(J560	31	1.5
		HP3-M-DC110V	110	88	16.5	121	7,450	14.9	1.6

AC TYPE (50/60 Hz) at 60 Hz, 20°C 68°F

Type		Part No.	Nominal coil voltage, V AC	Pick-up voltage, V AC (max.)	Drop-out voltage, V AC (min.)	Max. allowable voltage, V AC	Inductance, H	Nominal coil current, mA	Nominal operating power, VA
2 Form C Top Mounting Type (TM)		HP2-TM-AC6V	6	4.8	1.8	6.6	0.049	310	1.9
		HP2-TM-AC12V	12	9.6	3.6	13.2	0.190	160	1.9
		HP2-TM-AC24V	24	19.2	7.2	26.4	0.776	78	1.9
		HP2-TM-AC48V	48	38.4	14.4	52.8	3.106	39	1.9
		HP2-TM-AC115V	115	92	34.5	126.5	15.83	18	2.1
		HP2-TM-AC220V	220	176	66	242	57.90	9.5	2.1
		HP2-TM-AC240V	240	192	72	264	66.26	9.0	2.2
3 Form C Direct Mounting Type (M)		HP3-M-AC6V	6	4.8	1.8	6.6	0.030	520	3.1
		HP3-M-AC12V	12	9.6	3.6	13.2	0.119	260	3.1
		HP3-M-AC24V	24	19.2	7.2	26.4	0.475	130	3.1
		HP3-M-AC48V	48	38.4	14.4	52.8	1.899	65	3.1
		HP3-M-AC115V	115	92	34.5	126.5	10.36	28.5	3.3
		HP3-M-AC220V	220	176	66	242	39.32	14.2	3.1
		HP3-M-AC240V	240	192	72	264	44.05	13.9	3.3

4. Direct mounting (with lamp wired) type

DC TYPES

Type	Part No.	Nominal coil voltage, V DC	Pick-up voltage, V DC (max.)	Drop-out voltage, V DC (min.)	Max. allowable voltage, V DC	Coil resistance, Ω ($\pm 10\%$)	Nominal coil current, mA	Nominal operating power, W
3 Form C Neon lamp	HP3-ML-DC110V	110	88	16.5	121	7,450	14.9	1.6

AC TYPE (50/60 Hz) at 60 Hz, 20°C 68°F

Type	Part No.	Nominal coil voltage, V AC	Pick-up voltage, V AC (max.)	Drop-out voltage, V AC (min.)	Max. allowable voltage, V AC	Inductance, H	Nominal coil current, mA	Nominal operating power, VA
3 Form C Neon lamp	HP3-ML-AC115V	115 V	92	34.5	126.5	10.36	28.5	3.3
	HP3-ML-AC220V	220 V	176	66	242	39.32	14.2	3.1
	HP3-ML-AC240V	240 V	192	72	264	44.05	13.9	3.3

LAMP-WIRED RELAYS

Specifications

Life of neon lamp.....continuous: more than 25,000 hours
(more than 3 years)

on/off = 1: more than 6 years

Life of LEDcontinuous: more than 50,000 hours
(more than 5.5 years)

on/off = 1: more than 100,000 hours
(more than 11 years)

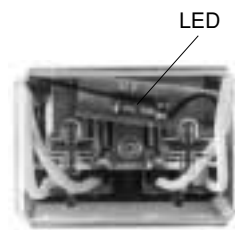
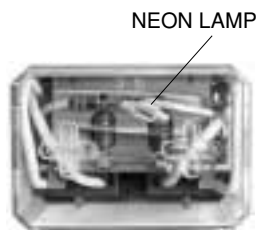

Variation

Type	Coil Voltage		
	AC	DC	
HP2-L HP3-L HP3-ML HP4-L	6 V	6 V	LED (Light emitting diode)
	12 V	12 V	
	24 V	24 V	
	—	48 V	
	115 V	110 V	
	220 V	—	Neon lamp
240 V	—		

Notes:

1. AC 48 V type is not available for lamp wiring.

Circuit diagrams

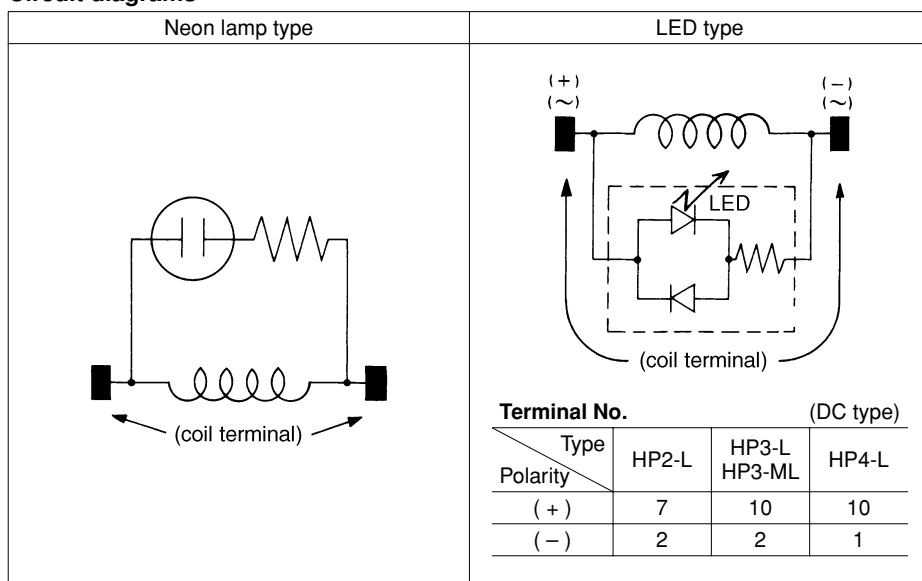

Notes:

1. Pay attention to the polarity of coil See circuit diagram (LED type only).

Operating current of LED

Coil Voltage	Operating current of LED
DC 6V	DC 6.4 mA
DC 12V	DC 5.7 mA
DC 24V	DC 4.7 mA
DC 48V	DC 4.5 mA
AC 6V	AC 10.5 mA
AC 12V	AC 9.0 mA
AC 24V	AC 7.7 mA











Notes:

1. Operating current of relays should be increased by the value of LED operating current. Please refer the table. Operating current of neon lamp is approx. 0.3 mA to 0.4 mA.

2. To use the HP relay in the inductive load circuit, the contact protection circuit is recommended.

ACCESSORIES

Please refer to "MOUNTING METHODS" for further information.
UL, CSA recognized except BRACKET and INSERTING PLATE.

HP	Relay	Solder terminal socket for rectangular hold boring (with hold-down clip)	Screw terminal socket for DIN rail assembly (with hold-down clip)	For HP2, HP4
HP2		HP2-SRS  (UL, CSA, VDE)	HP2-SFD  (UL, CSA)	HP-BRACKET for direct mounting 
HP3		HP3-SRS  (UL, CSA, VDE)	HP3-SFD  (UL, CSA)	
HP4		HP4-SRS  (UL, CSA)	HP4-SFD  (UL, CSA)	HP INSERTION PLATE for P/C board mounting 

DIMENSIONS AND WIRING DIAGRAM

mm inch

HP2 (2 Form C) Plug-in terminal types

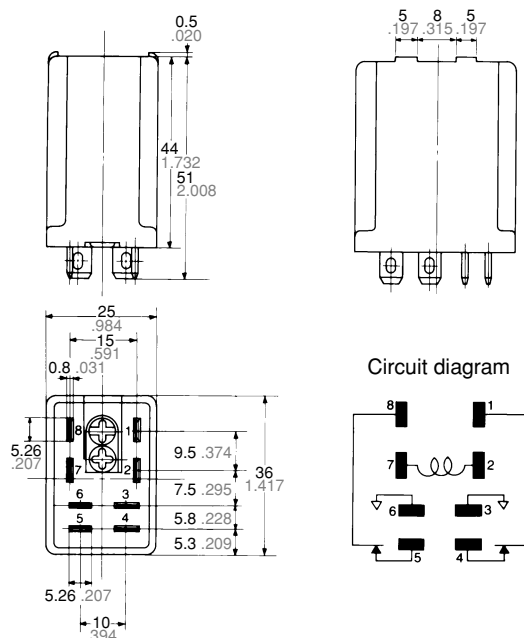

Dimension :	General tolerance
Max. 2mm .079 inch:	±0.2 ±.008
2 to 9mm .079 to .354 inch:	±0.5 ±.020
9 to 20mm .354 to .787 inch:	±1.0 ±.039
Min. 20mm .787 inch:	±1.5 ±.059

Accepts
Faston 205

HP2-SRS (with hold-down clip)

Optimum space-saving panel cut-out.
Can be mounted from either the front or the rear of the panel.

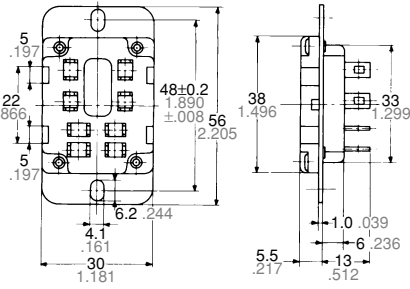

Dimension :	General tolerance
Max. 2mm .079 inch:	$\pm 0.2 \pm 0.08$
2 to 9mm .079 to .354 inch:	$\pm 0.5 \pm 0.20$
9 to 20mm .354 to .787 inch:	$\pm 1.0 \pm 0.39$
Min. 20mm .787 inch:	$\pm 1.5 \pm 0.59$

Front surface-mounting

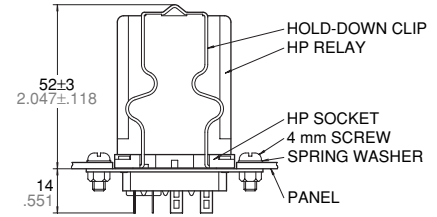
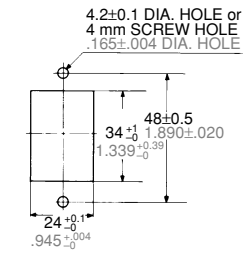

Rear surface-mounting

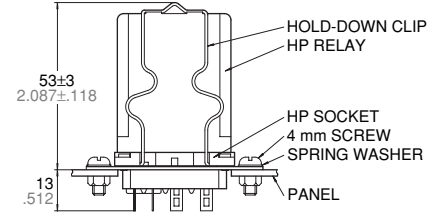
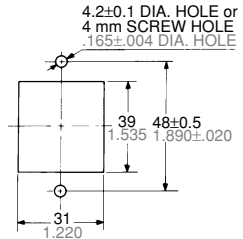

HP2-SFD (with hold-down clip)

Front wiring in restricted space

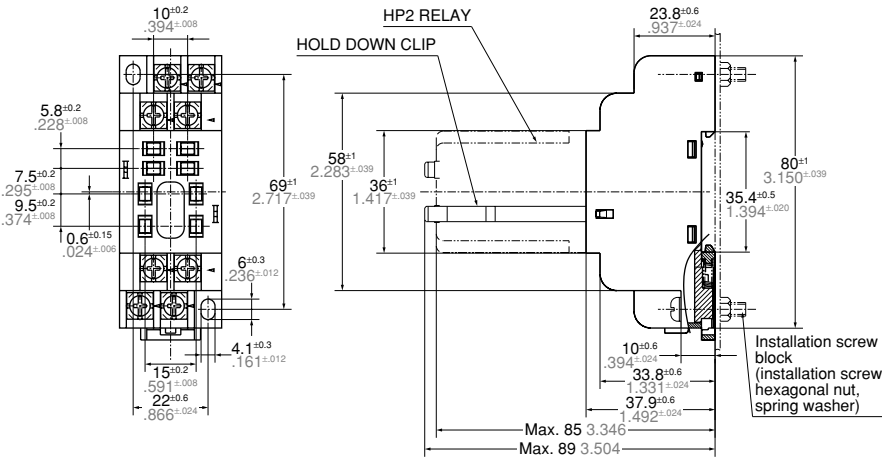

Dimension :	General tolerance
Max. 2mm .079 inch:	$\pm 0.2 \pm 0.08$
2 to 9mm .079 to .354 inch:	$\pm 0.5 \pm 0.20$
9 to 20mm .354 to .787 inch:	$\pm 1.0 \pm 0.39$
Min. 20mm .787 inch:	$\pm 1.5 \pm 0.59$

Mounting dimensions

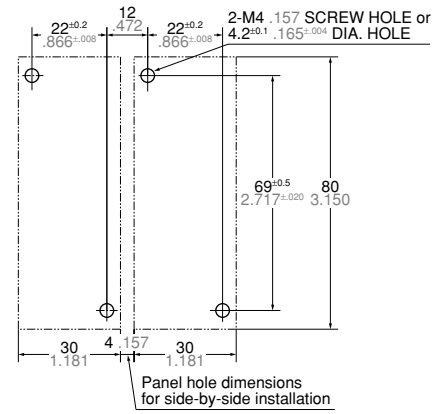

Note: Hold down clip and installation screw block are included in package.

HP2-TM (2 Form C) Top mounting types

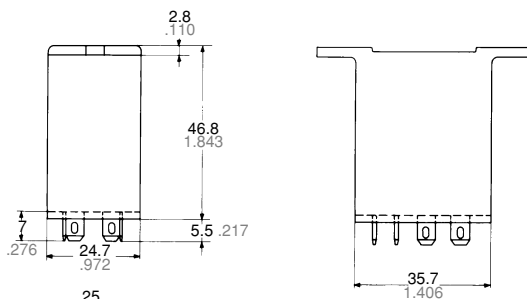

Circuit diagram

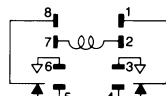

Dimension :	General tolerance
Max. 2mm .079 inch:	$\pm 0.2 \pm 0.08$
2 to 9mm .079 to .354 inch:	$\pm 0.5 \pm 0.20$
9 to 20mm .354 to .787 inch:	$\pm 1.0 \pm 0.39$
Min. 20mm .787 inch:	$\pm 1.5 \pm 0.59$

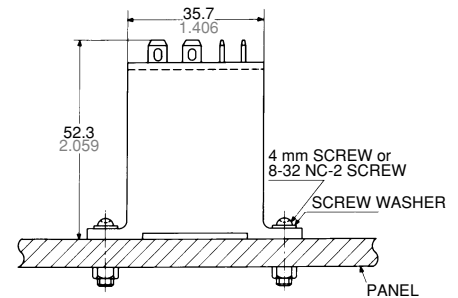

Mounting dimensions

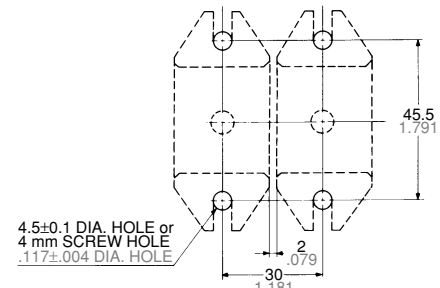

Accepts
Faston 205

HP3-M (3 Form C) Direct mounting types

mm inch

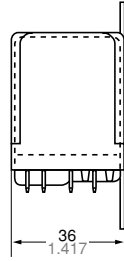
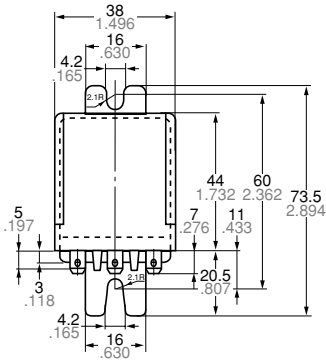

Mounting dimension

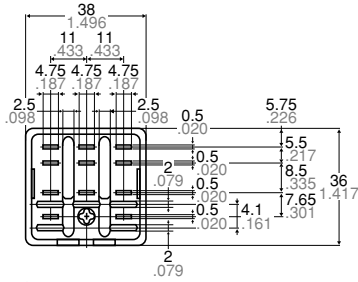
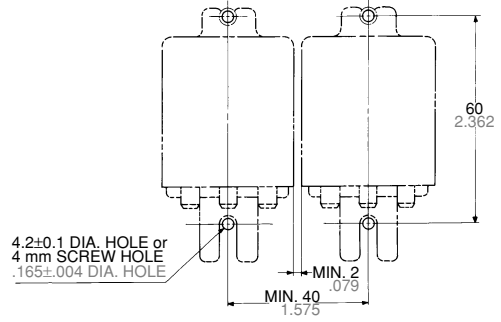

Circuit diagram

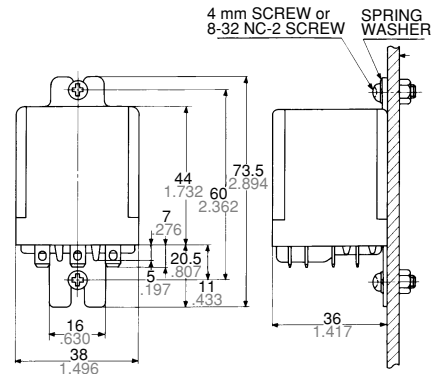
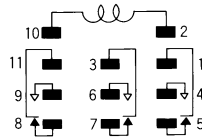

Accepts
Faston 187

Dimension :	General tolerance
Max. 2mm .079 inch:	±0.2 ±.008
2 to 9mm .079 to .354 inch:	±0.5 ±.020
9 to 20mm .354 to .787 inch:	±1.0 ±.039
Min. 20mm .787 inch:	±1.5 ±.059

HP4 (4 Form C) Plug-in terminal types

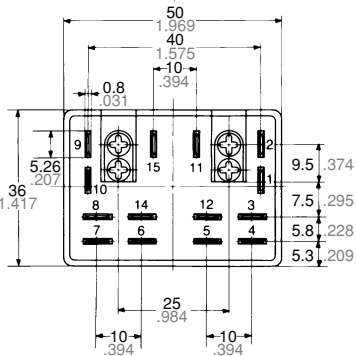
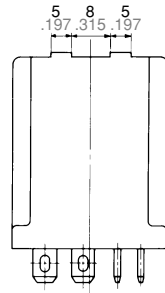
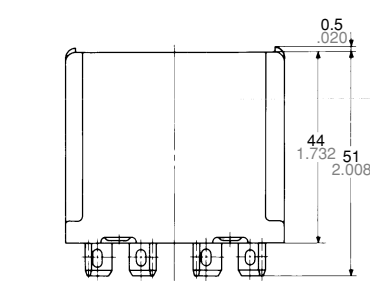

Circuit diagram

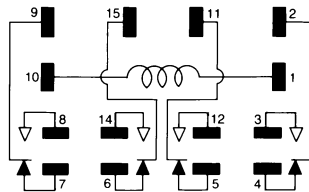

Accepts
Faston 187

Dimension :	General tolerance
Max. 2mm .079 inch:	±0.2 ±.008
2 to 9mm .079 to .354 inch:	±0.5 ±.020
9 to 20mm .354 to .787 inch:	±1.0 ±.039
Min. 20mm .787 inch:	±1.5 ±.059

HP4-SRS (with hold-down clip)

Optimum space-saving panel cut-out.
Can be mounted from either the front or the rear of the panel.

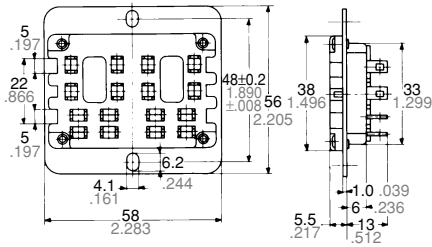

Dimension :	General tolerance
Max. 2mm .079 inch:	±0.2 ±.008
2 to 9mm .079 to .354 inch:	±0.5 ±.020
9 to 20mm .354 to .787 inch:	±1.0 ±.039
Min. 20mm .787 inch:	±1.5 ±.059

Front surface-mounting

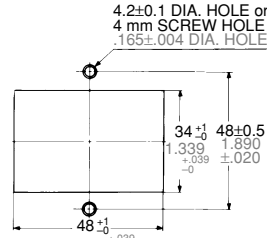

Rear surface-mounting

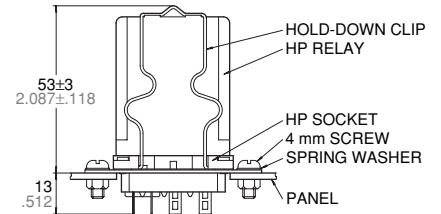
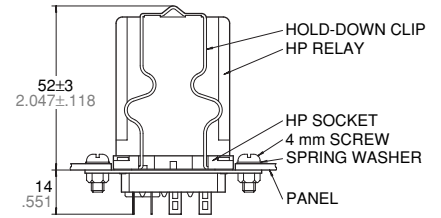
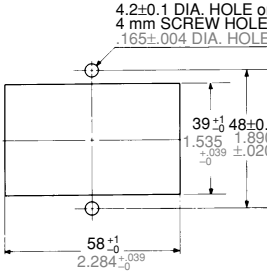

HP4-SFD (with hold-down clip)

Front wiring in restricted space.
Two HP2 relays can be mounted in one socket.

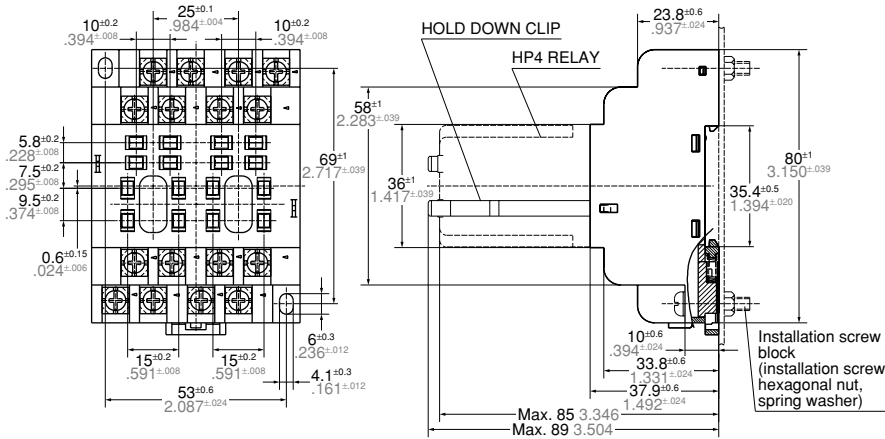

Dimension :	General tolerance
Max. 2mm .079 inch:	±0.2 ±.008
2 to 9mm .079 to .354 inch:	±0.5 ±.020
9 to 20mm .354 to .787 inch:	±1.0 ±.039
Min. 20mm .787 inch:	±1.5 ±.059

Mounting dimensions

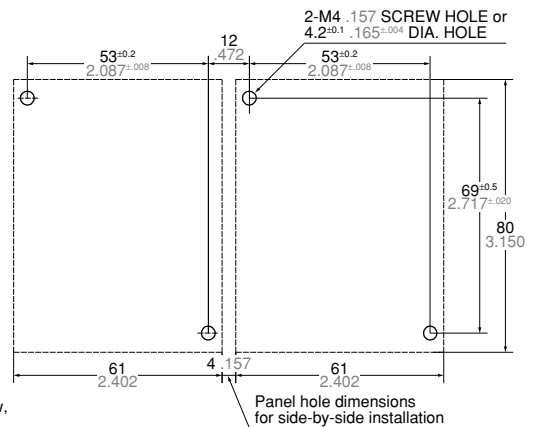

Note: Hold down clip and installation screw block are included in package.

ACCESSORIES for HP2 and HP4 types

HP Bracket (with 2 screws, 2 washers)
The HP Bracket is used for mounting HP2 relays and HP4 relays directly to the panel. It facilitates soldering or quick connections with Faston 205 tab 0.8 mm .031 inch.

Notes:

1. This bracket is unavailable for UL, CSA and VDE applications.
2. When using the special bracket, it is recommended to use the screws and washers called out in the chart in the next page in order to eliminate any possible damage to the relay coil.

Mounting methods

(a) Remove the M3 × 7 screw (red colored) fixed to the relay, and place the bracket on the relay with the attaching M3 × 7 screw (blue colored) and the spring washer.

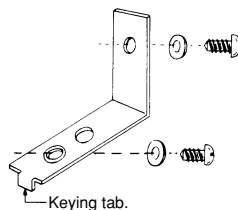

(b) Use the additional M3 × 7 screw and washer for attaching the bracket to the panel.

For the HP4 type relay two brackets are used

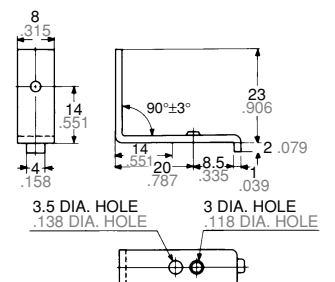

HP

Thickness of a special bracket	1.0 mm (.039 inch)	1.6 mm (.063 inch)	2.0 mm (.079 inch)
A suitable screw	M3 × 7-M3 × 8	M3 × 8	M3 × 8-M3 × 10
A suitable washer	for M3	for M3	for M3

Millimeter	Screw	M	3	×	7
3mm .118inch diameter					
7mm .276inch length					

Dimensions and mounting method

mm inch

1. Rear-surface mounting

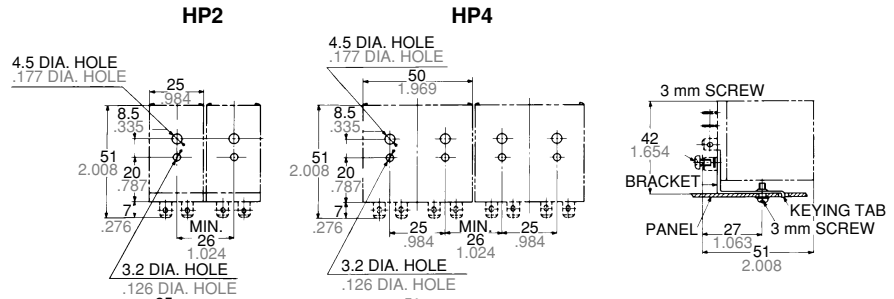

2. Front-surface mounting

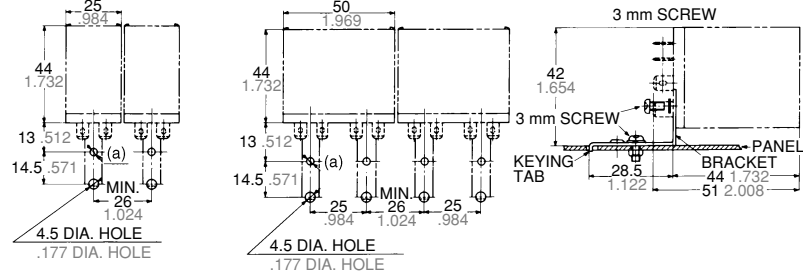

HP Inserting Plate for HP2 and HP4 types

1. HP inserting plate is used for mounting HP2 and HP4 relays on a printed board to adjust the length of the terminals.

2. If adjustment by soldering is not suitable, bore 1/8" diameter hole on the printed circuit board and mount the relay with a M3 × 10 screw. The chart to the right suggests the proper screws for different printed circuit boards.

3. Two plates are used for the HP4 type relay.

Thickness of P/C board	Suitable screw
1.0 mm .039 inch	M3 × 10
1.2 mm .047 inch	M3 × 10

PC board pattern

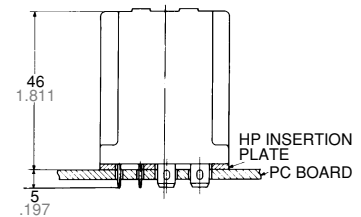
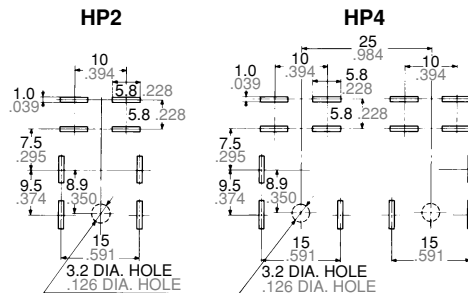
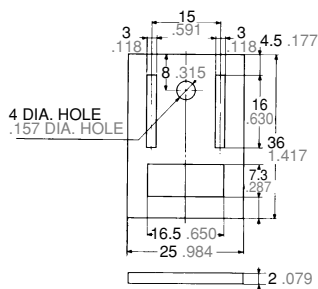

Please refer to the above second instruction.

Tolerance: ±0.1 ±.004

For Cautions for Use, see Relay Technical Information