

阅读申明

- 1.本站收集的数据手册和产品资料都来自互联网，版权归原作者所有。如读者和版权方有任何异议请及时告之，我们将妥善解决。
- 2.本站提供的中文数据手册是英文数据手册的中文翻译，其目的是协助用户阅读，该译文无法自动跟随原稿更新，同时也可能存在翻译上的不当。建议读者以英文原稿为参考以便获得更精准的信息。
- 3.本站提供的产品资料，来自厂商的技术支持或者使用者的心得体会等，其内容可能存在描述上的差异，建议读者做出适当判断。
- 4.如需与我们联系，请发邮件到marketing@iczoom.com，主题请标有“数据手册”字样。

Read Statement

1. The datasheets and other product information on the site are all from network reference or other public materials, and the copyright belongs to the original author and original published source. If readers and copyright owners have any objections, please contact us and we will deal with it in a timely manner.
2. The Chinese datasheets provided on the website is a Chinese translation of the English datasheets. Its purpose is for reader's learning exchange only and do not involve commercial purposes. The translation cannot be automatically updated with the original manuscript, and there may also be improper translations. Readers are advised to use the English manuscript as a reference for more accurate information.
3. All product information provided on the website refer to solutions from manufacturers' technical support or users the contents may have differences in description, and readers are advised to take the original article as the standard.
4. If you have any questions, please contact us at marketing@iczoom.com and mark the subject with "Datasheets" .

Panasonic
ideas for life

10 AMP POWER RELAY

HP RELAYS

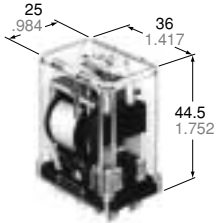

mm inch

FEATURES

- Interchangeable with existing models
- Long life and high reliability
- High contact capacity up to 10 A 250 V AC
- Available with plug-in/solder and quick-connect terminals

SPECIFICATIONS (at 20°C 68°F)

Contacts

| Arrangement | | 2 Form C | 3 Form C | 4 Form C |
|---|---------------------------------------|---------------------------|----------|--------------|
| Initial contact resistance, max. (By voltage drop 6 V DC 1 A) | | 15 mΩ | | |
| Contact material | | Silver | | Silver alloy |
| Rating | Nominal switching capacity | 10 A 250 V AC (resistive) | | |
| | Min. switching capacity ^{#1} | 100 mA, 5 V DC | | |

#1 This value can change due to the switching frequency, environmental conditions, and desired reliability level, therefore it is recommended to check this with the actual load.

Remarks

- * Specifications will vary with foreign standards certification ratings.
- *1 Measurement at same location as "initial breakdown voltage" section
- *2 Detection current; 10 mA
- *3 Excluding contact bounce time
- *4 Half-wave pulse of sine wave: 11ms; detection time: 10μs
- *5 Half-wave pulse of sine wave: 6ms
- *6 Detection time: 10μs
- *7 Refer to 6. Conditions for operation, transport and storage mentioned in AMBIENT ENVIRONMENT

Characteristics (at 60 Hz, 20°C 68°F)

| | | 2 Form C | 3 Form C | 4 Form C |
|--|---------------------------|--------------------------------------|-------------------------|-------------------------|
| Maximum operating speed | | 20 cpm | | |
| Initial insulation resistance ^{*1} | | more than 100 MΩ at 500 V DC | | |
| Breakdown voltage ^{*2} | Between open contacts | 1,000 Vrms | 2,000 Vrms | 1,000 Vrms |
| | Between contact sets | 1,500 Vrms | 2,000 Vrms | 1,500 Vrms |
| | Between contact and coil | 1,500 Vrms | 2,000 Vrms | 1,500 Vrms |
| Operate time ^{*3} (at nominal voltage) | | Max. 25 ms | Max. 30 ms | |
| Release time (without diode) ^{*3} (at nominal voltage) | | Max. 25 ms | Max. 30 ms | |
| Temperature rise | | Max. 65°C | | |
| Shock resistance | Functional ^{*4} | 98 m/s ² {10 G} | | |
| | Destructive ^{*5} | 980 m/s ² {100 G} | | |
| Vibration resistance | Functional ^{*6} | 10 to 55 Hz at 1 mm double amplitude | | |
| | Destructive | 10 to 55 Hz at 2 mm double amplitude | | |
| Conditions for operation, transport and storage ^{*7} (Not freezing and condensing at low temperature) | Ambient temp. | -50°C to +40°C -58°F to +104°F | | |
| | Humidity | 5 to 85% R.H. | | |
| Unit weight | | Approx. 60g 2.12 oz | Approx. 100g 3.53 oz | Approx. 125g 4.41 oz |

LIFE DATA

Contact rating and expected life For AC load type

| | Voltage | 125 V AC | | 250 V AC | | Expected life (min. operations) |
|-----------------|---------|-----------------------|-------------------------|-----------------------|-------------------------|---------------------------------|
| | | Resistive (cos φ ≅ 1) | Inductive (cos φ ≅ 0.4) | Resistive (cos φ ≅ 1) | Inductive (cos φ ≅ 0.4) | |
| Electrical life | Load | — | — | 10 A | 7.5 A | 2×10 ⁵ |
| | | 10 A | 7.5 A | 7.5 A | 5 A | 5×10 ⁵ |
| | | 5 A | 3 A | 3 A | 2 A | 1×10 ⁶ |
| | | 1A | 0.7 A | 0.6 A | 0.4 A | 2×10 ⁶ |
| Mechanical life | | | | | | 1×10 ⁷ |

Note: When the electromagnet or exciting coil (Solenoid, etc.) is the load, the value of motor or lamp load is applicable.

Contact rating and expected life For DC load type

| | Voltage | 24 V DC | | 125 V DC | | Expected life (min. operations) |
|-----------------|---------|-----------------------|-------------------------|-----------------------|-------------------------|---------------------------------|
| | | Resistive (cos φ ≅ 1) | Inductive (cos φ ≅ 0.4) | Resistive (cos φ ≅ 1) | Inductive (cos φ ≅ 0.4) | |
| Electrical life | Current | — | 7 A | — | — | 2×10 ⁵ |
| | | 7.5 A | 5 A | 0.5 A | 0.4 A | 5×10 ⁵ |
| | | 5 A | 3 A | 0.3 A | 0.2 A | 1×10 ⁶ |
| | | 1A | 0.6 A | 0.1 A | 0.06 A | 2×10 ⁶ |
| Mechanical life | | | | | | 1×10 ⁷ |

Life curve

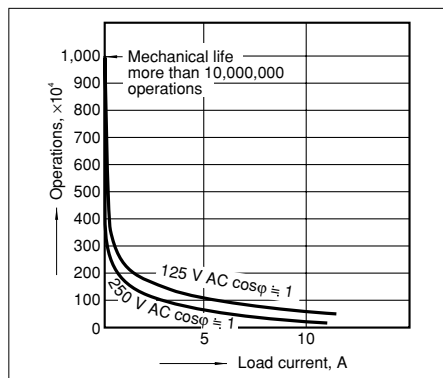

Notes:

1. For DC inductive loads, use an arc suppressing circuit.
2. When used under a DC load operating at high repetition rate with considerable arcing, corrosion of the contacts and/or the contact blades is likely to occur. When using the relay under conditions of high temperature, humidity or high repetition rate, it is suggested that the relay cover be removed to facilitate extended operation.

TYPICAL APPLICATIONS

HP relays enjoy wide use in various applications, particularly in automation controls and remote controls.

Applications include:
Industrial machinery

Machine tool
Food processing packing machines
Office equipment
Coin operate devices
Home appliances

Transportation
Communication and measuring devices
Amusement devices

ORDERING INFORMATION

Ex. HP 3 — M — AC240V

| Contact arrangement | Terminal | Coil voltage |
|---|--|--|
| 2: 2 Form C 3: 3 Form C 4: 4 Form C | Nil: Standard plug-in terminal M: Direct mounting (3 Form C only) TM: Top mounting (2 Form C only) L: Lamp wired, standard plug-in terminal | AC 6, 12, 24, 48, 115, 220, 240 V DC 6, 12, 24, 48, 110 V |

- (Notes) 1. For UL/CSA or VDE recognized types, add suffix UL/CSA or VDE (HP2-TM type VDE application under way)
2. Standard packing Carton: 50 pcs. Case: 200 pcs.
3. UL/CSA approved type is standard.

TYPES AND COIL DATA

1. Standard plug-in terminal type (without lamp wired)

DC TYPES at 20°C 68°F

| Type | Part No. | Nominal coil voltage, V DC | Pick-up voltage, V DC (max.) | Drop-out voltage, V DC (min.) | Max. allowable voltage, V DC | Coil resistance, Ω (±10%) | Nominal coil current, mA | Nominal operating power, W |
|----------|------------|----------------------------|------------------------------|-------------------------------|------------------------------|---------------------------|--------------------------|----------------------------|
| 2 Form C | HP2-DC6V | 6 | 4.8 | 0.9 | 6.6 | 25 | 240 | 1.5 |
| | HP2-DC12V | 12 | 9.6 | 1.8 | 13.2 | 110 | 109 | 1.3 |
| | HP2-DC24V | 24 | 19.2 | 3.6 | 26.4 | 440 | 54.5 | 1.3 |
| | HP2-DC48V | 48 | 38.4 | 7.2 | 52.8 | 1,800 | 26.7 | 1.3 |
| | HP2-DC110V | 110 | 88 | 16.5 | 121 | 7,300 | 15.0 | 1.7 |
| 3 Form C | HP3-DC6V | 6 | 4.8 | 0.9 | 6.6 | 24 | 250 | 1.5 |
| | HP3-DC12V | 12 | 9.6 | 1.8 | 13.2 | 100 | 120 | 1.4 |
| | HP3-DC24V | 24 | 19.2 | 3.6 | 26.4 | 400 | 60 | 1.4 |
| | HP3-DC48V | 48 | 38.4 | 7.2 | 52.8 | 1,560 | 31 | 1.5 |
| | HP3-DC110V | 110 | 88 | 16.5 | 121 | 7,450 | 14.9 | 1.6 |
| 4 Form C | HP4-DC6V | 6 | 4.8 | 0.9 | 6.6 | 22 | 273 | 1.6 |
| | HP4-DC12V | 12 | 9.6 | 1.8 | 13.2 | 95 | 127 | 1.5 |
| | HP4-DC24V | 24 | 19.2 | 3.6 | 26.4 | 380 | 63 | 1.5 |
| | HP4-DC48V | 48 | 38.4 | 7.2 | 52.8 | 1,500 | 32 | 1.5 |
| | HP4-DC110V | 110 | 88 | 16.5 | 121 | 7,000 | 15.7 | 1.7 |

AC TYPE (50/60 Hz) at 60 Hz, 20°C 68°F

| Type | Part No. | Nominal coil voltage, V AC | Pick-up voltage, V AC (max.) | Drop-out voltage, V AC (min.) | Max. allowable voltage, V AC | Inductance, H | Nominal coil current, mA | Nominal operating power, VA |
|----------|------------|----------------------------|------------------------------|-------------------------------|------------------------------|---------------|--------------------------|-----------------------------|
| 2 Form C | HP2-AC6V | 6 | 4.8 | 1.8 | 6.6 | 0.049 | 310 | 1.9 |
| | HP2-AC12V | 12 | 9.6 | 3.6 | 13.2 | 0.190 | 160 | 1.9 |
| | HP2-AC24V | 24 | 19.2 | 7.2 | 26.4 | 0.776 | 78 | 1.9 |
| | HP2-AC48V | 48 | 38.4 | 14.4 | 52.8 | 3.106 | 39 | 1.9 |
| | HP2-AC115V | 115 | 92 | 34.5 | 126.5 | 15.83 | 18 | 2.1 |
| | HP2-AC220V | 220 | 176 | 66 | 242 | 57.90 | 9.5 | 2.1 |
| | HP2-AC240V | 240 | 192 | 72 | 264 | 66.26 | 9.0 | 2.2 |
| 3 Form C | HP3-AC6V | 6 | 4.8 | 1.8 | 6.6 | 0.030 | 520 | 3.1 |
| | HP3-AC12V | 12 | 9.6 | 3.6 | 13.2 | 0.119 | 260 | 3.1 |
| | HP3-AC24V | 24 | 19.2 | 7.2 | 26.4 | 0.475 | 130 | 3.1 |
| | HP3-AC48V | 48 | 38.4 | 14.4 | 52.8 | 1.899 | 65 | 3.1 |
| | HP3-AC115V | 115 | 92 | 34.5 | 126.5 | 10.36 | 28.5 | 3.3 |
| | HP3-AC220V | 220 | 176 | 66 | 242 | 39.32 | 14.2 | 3.1 |
| | HP3-AC240V | 240 | 192 | 72 | 264 | 44.05 | 13.9 | 3.3 |
| 4 Form C | HP4-AC6V | 6 | 4.8 | 1.8 | 6.6 | 0.019 | 800 | 4.8 |
| | HP4-AC12V | 12 | 9.6 | 3.6 | 13.2 | 0.077 | 400 | 4.8 |
| | HP4-AC24V | 24 | 19.2 | 7.2 | 26.4 | 0.309 | 200 | 4.8 |
| | HP4-AC48V | 48 | 38.4 | 14.4 | 52.8 | 1.292 | 95 | 4.6 |
| | HP4-AC115V | 115 | 92 | 34.5 | 126.5 | 6.953 | 42 | 4.8 |
| | HP4-AC220V | 220 | 176 | 66 | 242 | 26.57 | 21 | 4.6 |
| | HP4-AC240V | 240 | 192 | 72 | 264 | 29.75 | 20.5 | 4.9 |

NOTES

- The range of coil current for AC relays is $\pm 15\%$ (60 Hz). For DC relays it is $\pm 10\%$ at 20°C, 68°F.
- The HP relay will operate in a range from 80% to 110% of the nominal coil voltage. It is, however, recommended that the relay be used in the range of 85% to 110% of the nominal coil voltage, with the temporary voltage variation taken into consideration.
- When the operating voltage of AC relays drops below 80% of the nominal coil voltage, the relay will generate a considerable amount of heat which is not recommended for maximum efficiency.
- The coil resistance of DC types is the measured value of the coil at a temperature of 20°C 68°F. If the coil temperature changes by $\pm 1^\circ\text{C}$, the measured value of the coil resistance should be increased or decreased by 0.4%.
- For applications from 220 V to 240 V DC, connect a resistor in series with the relay coil. See chart for resistor values.

| Voltage | 2 Form C | 3 Form C | 4 Form C |
|----------|-------------------------|--------------------------|-------------------------|
| 220 V DC | 7.3 k Ω (5 W) | 7.45 k Ω (5 W) | 7 k Ω (5 W) |
| 240 V DC | 8.7 k Ω (5 W) | 8.8 k Ω (5 W) | 8.3 k Ω (5 W) |

2. Standard plug-in terminal type (with lamp wired)

DC TYPES at 20°C 68°F

| Type | Part No. | Nominal coil voltage, V DC | Pick-up voltage, V DC (max.) | Drop-out voltage, V DC (min.) | Max. allowable voltage, V DC | Coil resistance, Ω ($\pm 10\%$) | Nominal coil current, mA | Nominal operating power, W | |
|----------|-----------|----------------------------|------------------------------|-------------------------------|------------------------------|--|--------------------------|----------------------------|-----|
| 2 Form C | LED | HP2-L-DC6V | 6 | 4.8 | 0.9 | 6.6 | 25 | 240 | 1.5 |
| | | HP2-L-DC12V | 12 | 9.6 | 1.8 | 13.2 | 110 | 109 | 1.3 |
| | | HP2-L-DC24V | 24 | 19.2 | 3.6 | 26.4 | 440 | 54.5 | 1.3 |
| | | HP2-L-DC48V | 48 | 38.4 | 7.2 | 52.8 | 1,800 | 26.7 | 1.3 |
| | Neon lamp | HP2-L-DC110V | 110 | 88 | 16.5 | 121 | 7,300 | 15.0 | 1.7 |
| 3 Form C | LED | HP3-L-DC6V | 6 | 4.8 | 0.9 | 6.6 | 24 | 250 | 1.5 |
| | | HP3-L-DC12V | 12 | 9.6 | 1.8 | 13.2 | 100 | 120 | 1.4 |
| | | HP3-L-DC24V | 24 | 19.2 | 3.6 | 26.4 | 400 | 60 | 1.4 |
| | | HP3-L-DC48V | 48 | 38.4 | 7.2 | 52.8 | 1,560 | 31 | 1.5 |
| | Neon lamp | HP3-L-DC110V | 110 | 88 | 16.5 | 121 | 7,450 | 14.9 | 1.6 |
| 4 Form C | LED | HP4-L-DC6V | 6 | 4.8 | 0.9 | 6.6 | 22 | 273 | 1.6 |
| | | HP4-L-DC12V | 12 | 9.6 | 1.8 | 13.2 | 95 | 127 | 1.5 |
| | | HP4-L-DC24V | 24 | 19.2 | 3.6 | 26.4 | 380 | 63 | 1.5 |
| | | HP4-L-DC48V | 48 | 38.4 | 7.2 | 52.8 | 1,500 | 32 | 1.5 |
| | Neon lamp | HP4-L-DC110V | 110 | 88 | 16.5 | 121 | 7,000 | 15.7 | 1.7 |

AC TYPE (50/60 Hz) at 60 Hz, 20°C 68°F

| Type | | Part No. | Nominal coil voltage, V AC | Pick-up voltage, V AC (max.) | Drop-out voltage, V AC (min.) | Max. allowable voltage, V AC | Inductance, H | Nominal coil current, mA | Nominal operating power, VA |
|----------|-----------|--------------|----------------------------|------------------------------|-------------------------------|------------------------------|---------------|--------------------------|-----------------------------|
| 2 Form C | LED | HP2-L-AC6V | 6 | 4.8 | 1.8 | 6.6 | 0.049 | 310 | 1.9 |
| | | HP2-L-AC12V | 12 | 9.6 | 3.6 | 13.2 | 0.190 | 160 | 1.9 |
| | | HP2-L-AC24V | 24 | 19.2 | 7.2 | 26.4 | 0.776 | 78 | 1.9 |
| | Neon lamp | HP2-L-AC115V | 115 | 92 | 34.5 | 126.5 | 15.83 | 18 | 2.1 |
| | | HP2-L-AC220V | 220 | 176 | 66 | 242 | 57.90 | 9.5 | 2.1 |
| | | HP2-L-AC240V | 240 | 192 | 72 | 264 | 66.26 | 9.0 | 2.2 |
| 3 Form C | LED | HP3-L-AC6V | 6 | 4.8 | 1.8 | 6.6 | 0.030 | 520 | 3.1 |
| | | HP3-L-AC12V | 12 | 9.6 | 3.6 | 13.2 | 0.119 | 260 | 3.1 |
| | | HP3-L-AC24V | 24 | 19.2 | 7.2 | 26.4 | 0.475 | 130 | 3.1 |
| | Neon lamp | HP3-L-AC115V | 115 | 92 | 34.5 | 126.5 | 10.36 | 28.5 | 3.3 |
| | | HP3-L-AC220V | 220 | 176 | 66 | 242 | 39.32 | 14.2 | 3.1 |
| | | HP3-L-AC240V | 240 | 192 | 72 | 264 | 44.05 | 13.9 | 3.3 |
| 4 Form C | LED | HP4-L-AC6V | 6 | 4.8 | 1.8 | 6.6 | 0.019 | 800 | 4.8 |
| | | HP4-L-AC12V | 12 | 9.6 | 3.6 | 13.2 | 0.077 | 400 | 4.8 |
| | | HP4-L-AC24V | 24 | 19.2 | 7.2 | 26.4 | 0.309 | 200 | 4.8 |
| | Neon lamp | HP4-L-AC115V | 115 | 92 | 34.5 | 126.5 | 6.953 | 42 | 4.8 |
| | | HP4-L-AC220V | 220 | 176 | 66 | 242 | 26.57 | 21 | 4.6 |
| | | HP4-L-AC240V | 240 | 192 | 72 | 264 | 29.75 | 20.5 | 4.9 |

3. Top Mounting (TM) and direct mounting (M) type

DC TYPES at 20°C 68°F

| Type | | Part No. | Nominal coil voltage, V DC | Pick-up voltage, V DC (max.) | Drop-out voltage, V DC (min.) | Max. allowable voltage, V DC | Coil resistance, Ω (±10%) | Nominal coil current, mA | Nominal operating power, W |
|---------------------------------------|--|---------------|----------------------------|------------------------------|-------------------------------|------------------------------|---------------------------|--------------------------|----------------------------|
| 2 Form C Top Mounting Type (TM) | | HP2-TM-DC6V | 6 | 4.8 | 0.9 | 6.6 | 25 | 240 | 1.5 |
| | | HP2-TM-DC12V | 12 | 9.6 | 1.8 | 13.2 | 110 | 109 | 1.3 |
| | | HP2-TM-DC24V | 24 | 19.2 | 3.6 | 26.4 | 440 | 54.5 | 1.3 |
| | | HP2-TM-DC48V | 48 | 38.4 | 7.2 | 52.8 | 1,800 | 26.7 | 1.3 |
| | | HP2-TM-DC110V | 110 | 88 | 16.5 | 121 | 7,300 | 15.0 | 1.7 |
| 3 Form C Direct Mounting Type (TM) | | HP3-M-DC6V | 6 | 4.8 | 0.9 | 6.6 | 24 | 250 | 1.5 |
| | | HP3-M-DC12V | 12 | 9.6 | 1.8 | 13.2 | 100 | 120 | 1.4 |
| | | HP3-M-DC24V | 24 | 19.2 | 3.6 | 26.4 | 400 | 60 | 1.4 |
| | | HP3-M-DC48V | 48 | 38.4 | 7.2 | 52.8 | 1\$B!(J560 | 31 | 1.5 |
| | | HP3-M-DC110V | 110 | 88 | 16.5 | 121 | 7,450 | 14.9 | 1.6 |

AC TYPE (50/60 Hz) at 60 Hz, 20°C 68°F

| Type | | Part No. | Nominal coil voltage, V AC | Pick-up voltage, V AC (max.) | Drop-out voltage, V AC (min.) | Max. allowable voltage, V AC | Inductance, H | Nominal coil current, mA | Nominal operating power, VA |
|--------------------------------------|--|---------------|----------------------------|------------------------------|-------------------------------|------------------------------|---------------|--------------------------|-----------------------------|
| 2 Form C Top Mounting Type (TM) | | HP2-TM-AC6V | 6 | 4.8 | 1.8 | 6.6 | 0.049 | 310 | 1.9 |
| | | HP2-TM-AC12V | 12 | 9.6 | 3.6 | 13.2 | 0.190 | 160 | 1.9 |
| | | HP2-TM-AC24V | 24 | 19.2 | 7.2 | 26.4 | 0.776 | 78 | 1.9 |
| | | HP2-TM-AC48V | 48 | 38.4 | 14.4 | 52.8 | 3.106 | 39 | 1.9 |
| | | HP2-TM-AC115V | 115 | 92 | 34.5 | 126.5 | 15.83 | 18 | 2.1 |
| | | HP2-TM-AC220V | 220 | 176 | 66 | 242 | 57.90 | 9.5 | 2.1 |
| | | HP2-TM-AC240V | 240 | 192 | 72 | 264 | 66.26 | 9.0 | 2.2 |
| 3 Form C Direct Mounting Type (M) | | HP3-M-AC6V | 6 | 4.8 | 1.8 | 6.6 | 0.030 | 520 | 3.1 |
| | | HP3-M-AC12V | 12 | 9.6 | 3.6 | 13.2 | 0.119 | 260 | 3.1 |
| | | HP3-M-AC24V | 24 | 19.2 | 7.2 | 26.4 | 0.475 | 130 | 3.1 |
| | | HP3-M-AC48V | 48 | 38.4 | 14.4 | 52.8 | 1.899 | 65 | 3.1 |
| | | HP3-M-AC115V | 115 | 92 | 34.5 | 126.5 | 10.36 | 28.5 | 3.3 |
| | | HP3-M-AC220V | 220 | 176 | 66 | 242 | 39.32 | 14.2 | 3.1 |
| | | HP3-M-AC240V | 240 | 192 | 72 | 264 | 44.05 | 13.9 | 3.3 |

4. Direct mounting (with lamp wired) type

DC TYPES

| Type | Part No. | Nominal coil voltage, V DC | Pick-up voltage, V DC (max.) | Drop-out voltage, V DC (min.) | Max. allowable voltage, V DC | Coil resistance, Ω ($\pm 10\%$) | Nominal coil current, mA | Nominal operating power, W |
|--------------------|---------------|----------------------------|------------------------------|-------------------------------|------------------------------|--|--------------------------|----------------------------|
| 3 Form C Neon lamp | HP3-ML-DC110V | 110 | 88 | 16.5 | 121 | 7,450 | 14.9 | 1.6 |

AC TYPE (50/60 Hz) at 60 Hz, 20°C 68°F

| Type | Part No. | Nominal coil voltage, V AC | Pick-up voltage, V AC (max.) | Drop-out voltage, V AC (min.) | Max. allowable voltage, V AC | Inductance, H | Nominal coil current, mA | Nominal operating power, VA |
|--------------------|---------------|----------------------------|------------------------------|-------------------------------|------------------------------|---------------|--------------------------|-----------------------------|
| 3 Form C Neon lamp | HP3-ML-AC115V | 115 V | 92 | 34.5 | 126.5 | 10.36 | 28.5 | 3.3 |
| | HP3-ML-AC220V | 220 V | 176 | 66 | 242 | 39.32 | 14.2 | 3.1 |
| | HP3-ML-AC240V | 240 V | 192 | 72 | 264 | 44.05 | 13.9 | 3.3 |

LAMP-WIRED RELAYS

Specifications

Life of neon lamp.....continuous: more than 25,000 hours
(more than 3 years)

on/off = 1: more than 6 years

Life of LEDcontinuous: more than 50,000 hours
(more than 5.5 years)

on/off = 1: more than 100,000 hours
(more than 11 years)

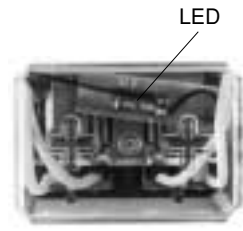
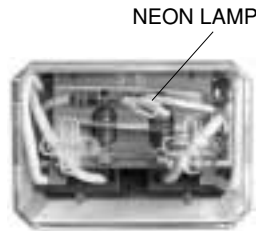

Variation

| Type | Coil Voltage | | |
|-----------------------------------|--------------|-------|----------------------------|
| | AC | DC | |
| HP2-L HP3-L HP3-ML HP4-L | 6 V | 6 V | LED (Light emitting diode) |
| | 12 V | 12 V | |
| | 24 V | 24 V | |
| | — | 48 V | |
| | 115 V | 110 V | |
| | 220 V | — | Neon lamp |
| 240 V | — | | |

Notes:

1. AC 48 V type is not available for lamp wiring.

Circuit diagrams

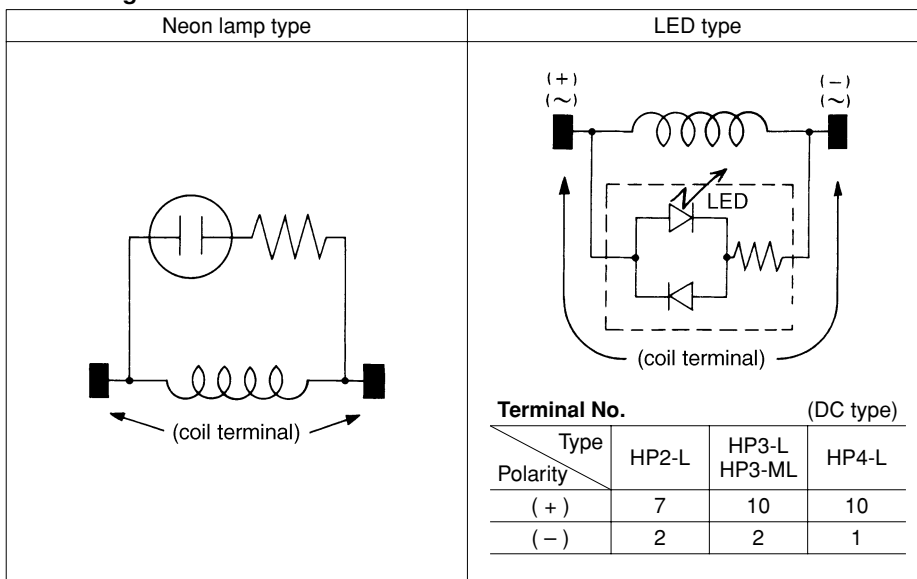

Notes:

1. Pay attention to the polarity of coil See circuit diagram (LED type only).

Operating current of LED

| Coil Voltage | Operating current of LED |
|--------------|--------------------------|
| DC 6V | DC 6.4 mA |
| DC 12V | DC 5.7 mA |
| DC 24V | DC 4.7 mA |
| DC 48V | DC 4.5 mA |
| AC 6V | AC 10.5 mA |
| AC 12V | AC 9.0 mA |
| AC 24V | AC 7.7 mA |











Notes:

1. Operating current of relays should be increased by the value of LED operating current. Please refer the table. Operating current of neon lamp is approx. 0.3 mA to 0.4 mA.

2. To use the HP relay in the inductive load circuit, the contact protection circuit is recommended.

ACCESSORIES

Please refer to "MOUNTING METHODS" for further information.
UL, CSA recognized except BRACKET and INSERTING PLATE.

| HP | Relay | Solder terminal socket for rectangular hold boring (with hold-down clip) | Screw terminal socket for DIN rail assembly (with hold-down clip) | For HP2, HP4 |
|-----|---|--|--|--|
| HP2 |  | HP2-SRS  (UL, CSA, VDE) | HP2-SFD  (UL, CSA) | HP-BRACKET for direct mounting  |
| HP3 |  | HP3-SRS  (UL, CSA, VDE) | HP3-SFD  (UL, CSA) | |
| HP4 |  | HP4-SRS  (UL, CSA) | HP4-SFD  (UL, CSA) | HP INSERTION PLATE for P/C board mounting  |

DIMENSIONS AND WIRING DIAGRAM

mm inch

HP2 (2 Form C) Plug-in terminal types

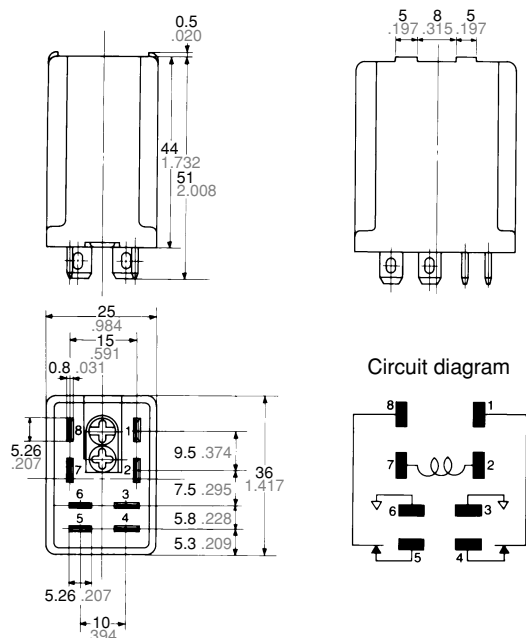

Accepts
Faston 205

| Dimension : | General tolerance |
|------------------------------|-------------------|
| Max. 2mm .079 inch: | ±0.2 ±.008 |
| 2 to 9mm .079 to .354 inch: | ±0.5 ±.020 |
| 9 to 20mm .354 to .787 inch: | ±1.0 ±.039 |
| Min. 20mm .787 inch: | ±1.5 ±.059 |

HP2-SRS (with hold-down clip)

Optimum space-saving panel cut-out.
Can be mounted from either the front or the rear of the panel.

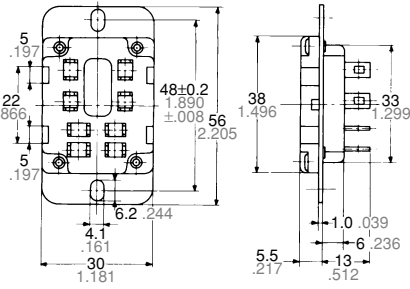

Front surface-mounting

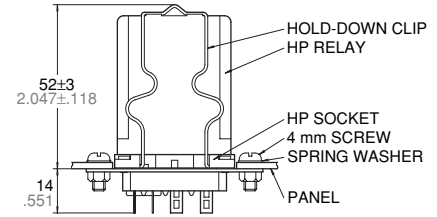
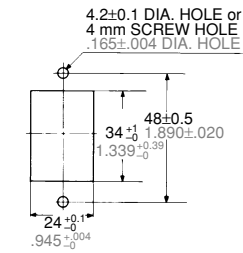

Rear surface-mounting

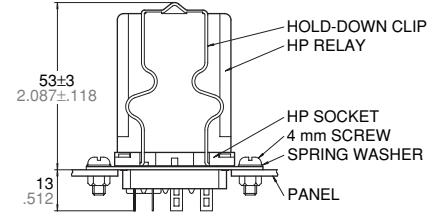
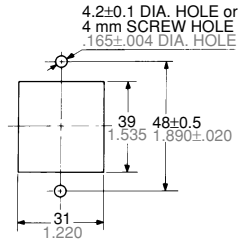

| Dimension : | General tolerance |
|------------------------------|-------------------|
| Max. 2mm .079 inch: | ±0.2 ±.008 |
| 2 to 9mm .079 to .354 inch: | ±0.5 ±.020 |
| 9 to 20mm .354 to .787 inch: | ±1.0 ±.039 |
| Min. 20mm .787 inch: | ±1.5 ±.059 |

HP2-SFD (with hold-down clip)

Front wiring in restricted space

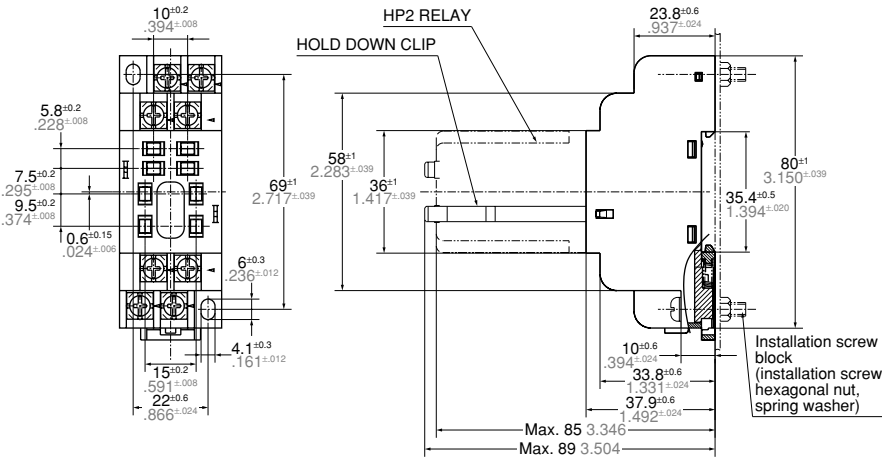

Mounting dimensions

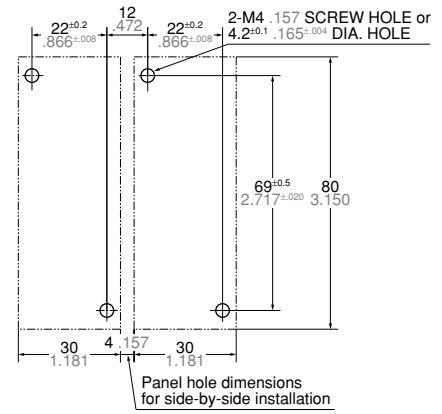

| Dimension : | General tolerance |
|------------------------------|-------------------|
| Max. 2mm .079 inch: | ±0.2 ±.008 |
| 2 to 9mm .079 to .354 inch: | ±0.5 ±.020 |
| 9 to 20mm .354 to .787 inch: | ±1.0 ±.039 |
| Min. 20mm .787 inch: | ±1.5 ±.059 |

Note: Hold down clip and installation screw block are included in package.

HP2-TM (2 Form C) Top mounting types

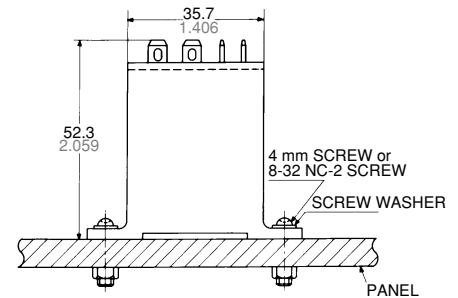
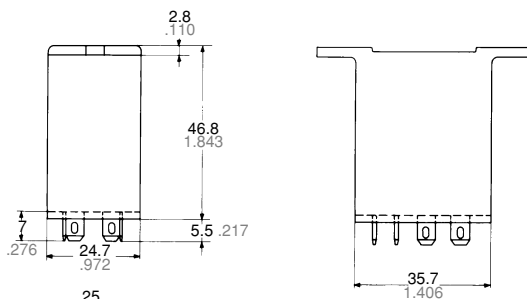

Circuit diagram

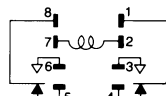

Mounting dimensions

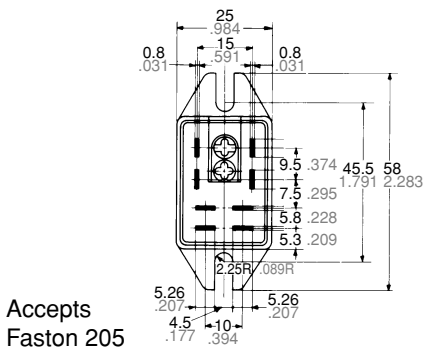
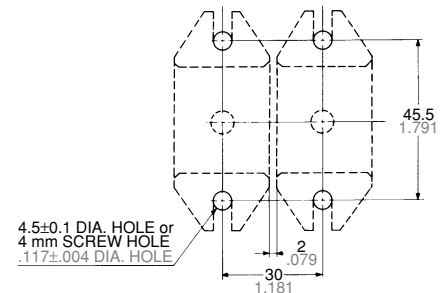

Accepts Faston 205

| Dimension : | General tolerance |
|------------------------------|-------------------|
| Max. 2mm .079 inch: | ±0.2 ±.008 |
| 2 to 9mm .079 to .354 inch: | ±0.5 ±.020 |
| 9 to 20mm .354 to .787 inch: | ±1.0 ±.039 |
| Min. 20mm .787 inch: | ±1.5 ±.059 |

HP3 (3 Form C) Plug-in terminal types

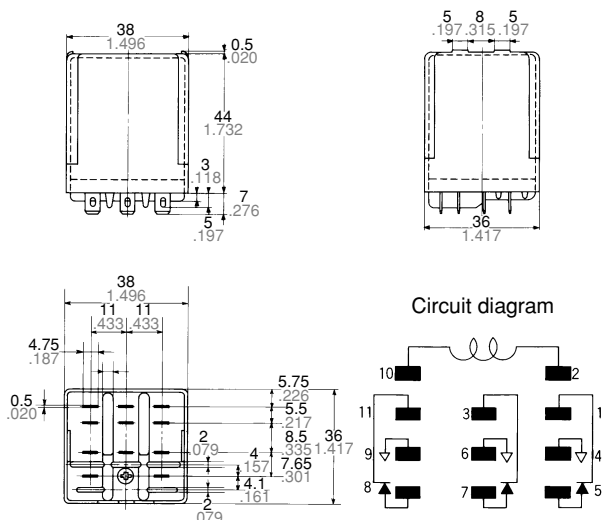

| Dimension : | General tolerance |
|------------------------------|--------------------|
| Max. 2mm .079 inch: | $\pm 0.2 \pm 0.08$ |
| 2 to 9mm .079 to .354 inch: | $\pm 0.5 \pm 0.20$ |
| 9 to 20mm .354 to .787 inch: | $\pm 1.0 \pm 0.39$ |
| Min. 20mm .787 inch: | $\pm 1.5 \pm 0.59$ |

Accepts
Faston 187

HP3-SRS (with hold-down clip)

Optimum space-saving panel cut-out.
Can be mounted from either the front or the rear of the panel.

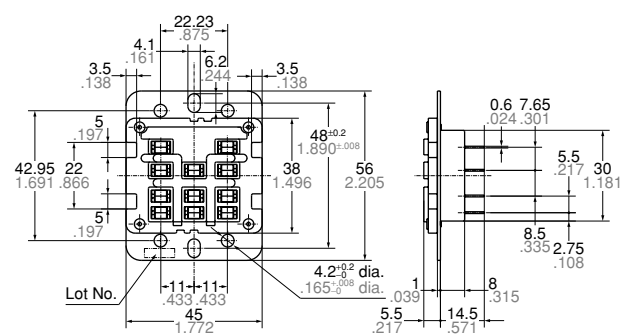

Front surface-mounting

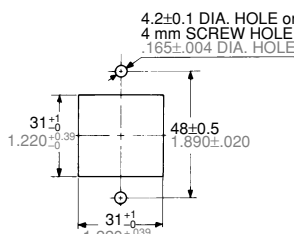

Rear surface-mounting

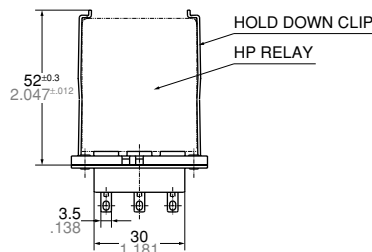
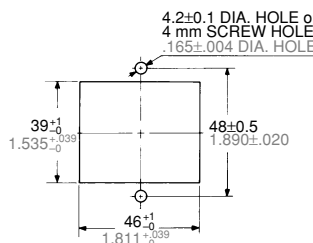

| Dimension : | General tolerance |
|------------------------------|--------------------|
| Max. 2mm .079 inch: | $\pm 0.2 \pm 0.08$ |
| 2 to 9mm .079 to .354 inch: | $\pm 0.5 \pm 0.20$ |
| 9 to 20mm .354 to .787 inch: | $\pm 1.0 \pm 0.39$ |
| Min. 20mm .787 inch: | $\pm 1.5 \pm 0.59$ |

HP3-SFD (with hold-down clip)

Front wiring in restricted space

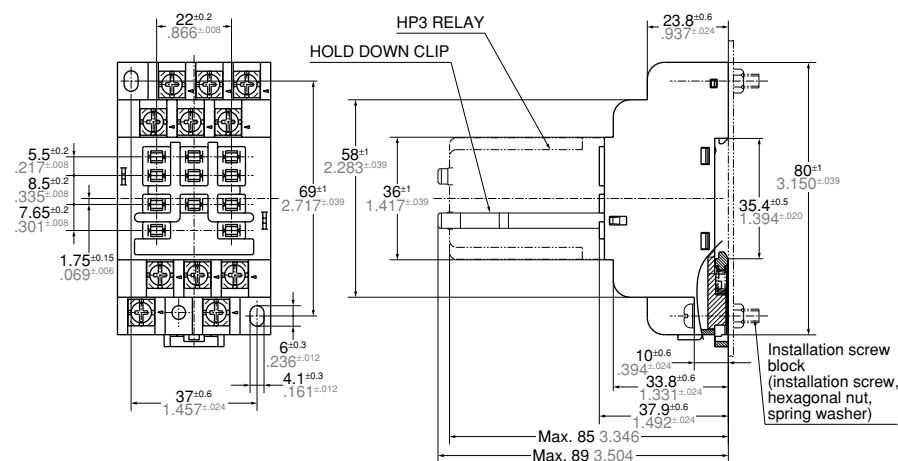

Mounting dimensions

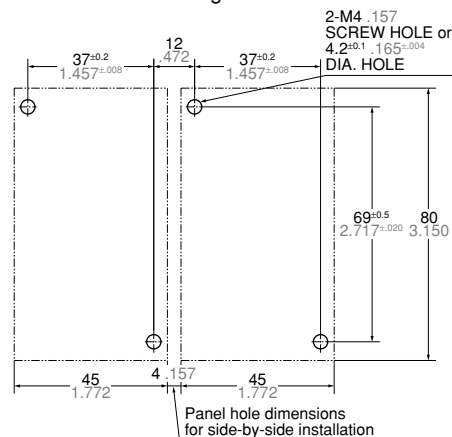

| Dimension : | General tolerance |
|------------------------------|--------------------|
| Max. 2mm .079 inch: | $\pm 0.2 \pm 0.08$ |
| 2 to 9mm .079 to .354 inch: | $\pm 0.5 \pm 0.20$ |
| 9 to 20mm .354 to .787 inch: | $\pm 1.0 \pm 0.39$ |
| Min. 20mm .787 inch: | $\pm 1.5 \pm 0.59$ |

Note: Hold down clip and installation screw block are included in package.

HP3-M (3 Form C) Direct mounting types

mm inch

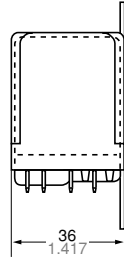
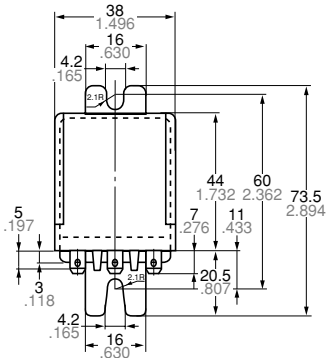

Mounting dimension

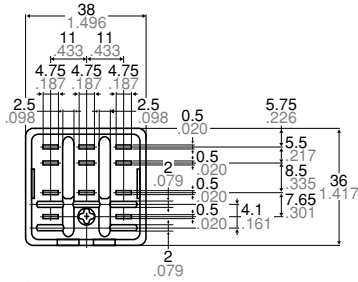
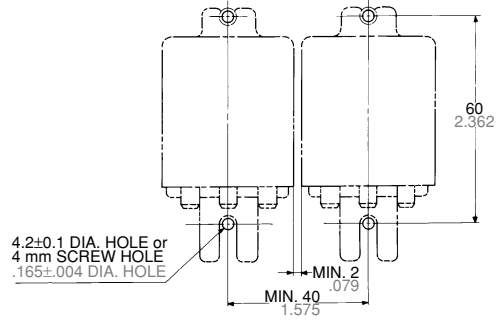

Circuit diagram

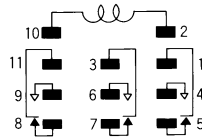

4 mm SCREW or 8-32 NC-2 SCREW SPRING WASHER

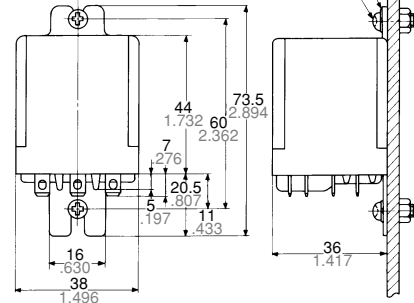

Accepts
Faston 187

| Dimension : | General tolerance |
|------------------------------|-------------------|
| Max. 2mm .079 inch: | ±0.2 ±.008 |
| 2 to 9mm .079 to .354 inch: | ±0.5 ±.020 |
| 9 to 20mm .354 to .787 inch: | ±1.0 ±.039 |
| Min. 20mm .787 inch: | ±1.5 ±.059 |

HP4 (4 Form C) Plug-in terminal types

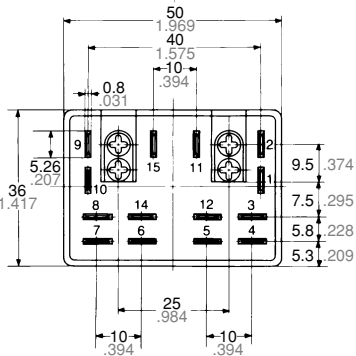
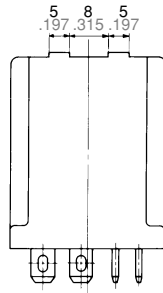
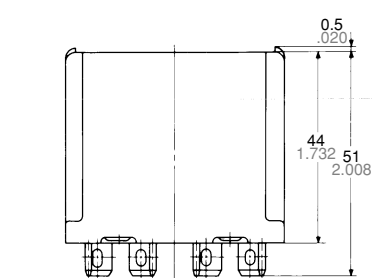

Circuit diagram

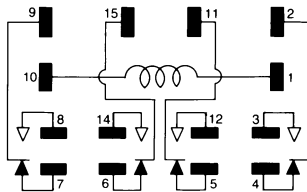

Accepts
Faston 187

| Dimension : | General tolerance |
|------------------------------|-------------------|
| Max. 2mm .079 inch: | ±0.2 ±.008 |
| 2 to 9mm .079 to .354 inch: | ±0.5 ±.020 |
| 9 to 20mm .354 to .787 inch: | ±1.0 ±.039 |
| Min. 20mm .787 inch: | ±1.5 ±.059 |

HP4-SRS (with hold-down clip)

Optimum space-saving panel cut-out.
Can be mounted from either the front or the rear of the panel.

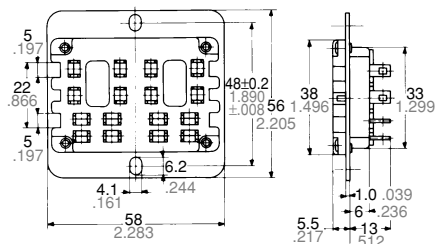

| Dimension : | General tolerance |
|------------------------------|-------------------|
| Max. 2mm .079 inch: | ±0.2 ±.008 |
| 2 to 9mm .079 to .354 inch: | ±0.5 ±.020 |
| 9 to 20mm .354 to .787 inch: | ±1.0 ±.039 |
| Min. 20mm .787 inch: | ±1.5 ±.059 |

Front surface-mounting

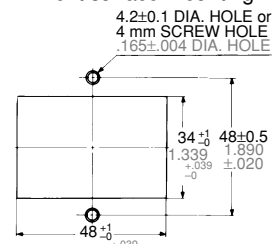

Rear surface-mounting

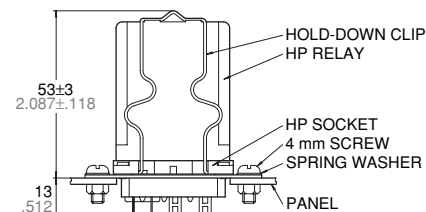
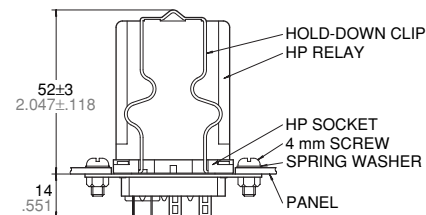
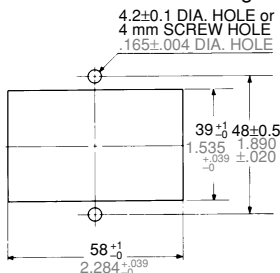

HP4-SFD (with hold-down clip)

Front wiring in restricted space.
Two HP2 relays can be mounted in one socket.

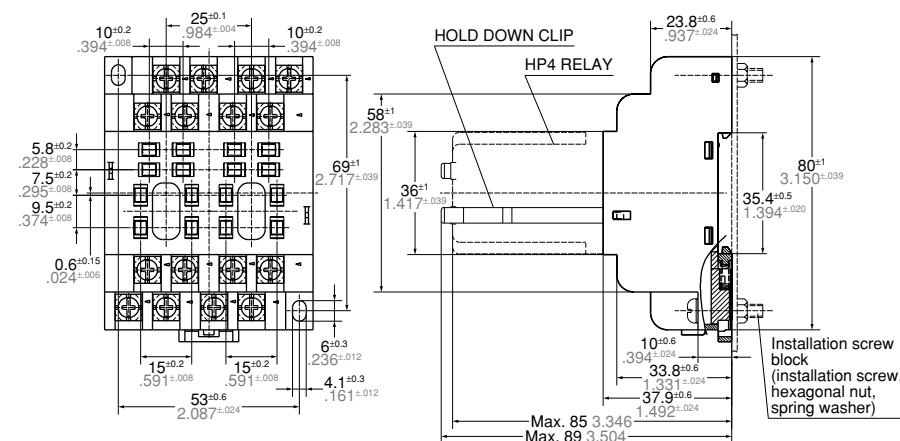

| Dimension : | General tolerance |
|------------------------------|-------------------|
| Max. 2mm .079 inch: | ±0.2 ±.008 |
| 2 to 9mm .079 to .354 inch: | ±0.5 ±.020 |
| 9 to 20mm .354 to .787 inch: | ±1.0 ±.039 |
| Min. 20mm .787 inch: | ±1.5 ±.059 |

Mounting dimensions

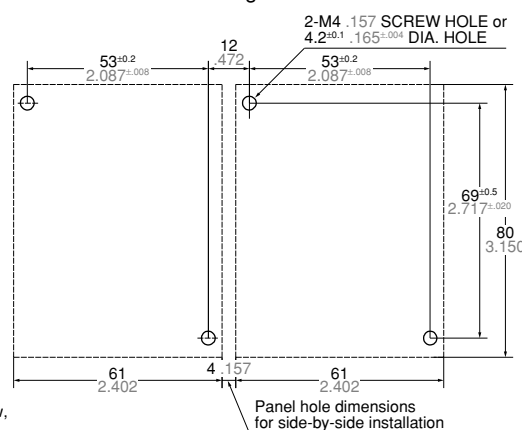

Note: Hold down clip and installation screw block are included in package.

ACCESSORIES for HP2 and HP4 types

HP Bracket (with 2 screws, 2 washers)
The HP Bracket is used for mounting HP2 relays and HP4 relays directly to the panel. It facilitates soldering or quick connections with Faston 205 tab 0.8 mm .031 inch.

Notes:

1. This bracket is unavailable for UL, CSA and VDE applications.
2. When using the special bracket, it is recommended to use the screws and washers called out in the chart in the next page in order to eliminate any possible damage to the relay coil.

Mounting methods

(a) Remove the M3 × 7 screw (red colored) fixed to the relay, and place the bracket on the relay with the attaching M3 × 7 screw (blue colored) and the spring washer.

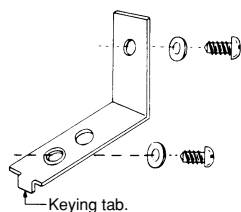

(b) Use the additional M3 × 7 screw and washer for attaching the bracket to the panel.

For the HP4 type relay two brackets are used

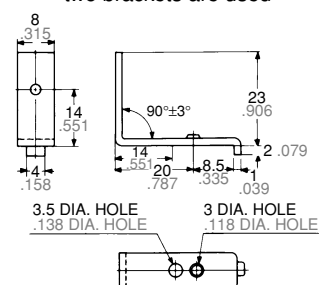

HP

| | | | |
|--------------------------------|--------------------|--------------------|--------------------|
| Thickness of a special bracket | 1.0 mm (.039 inch) | 1.6 mm (.063 inch) | 2.0 mm (.079 inch) |
| A suitable screw | M3 × 7-M3 × 8 | M3 × 8 | M3 × 8-M3 × 10 |
| A suitable washer | for M3 | for M3 | for M3 |

| | | | | | |
|-----------------------|-------|---|---|---|---|
| Millimeter | Screw | M | 3 | × | 7 |
| 3mm .118inch diameter | | | | | |
| 7mm .276inch length | | | | | |

Dimensions and mounting method

mm inch

1. Rear-surface mounting

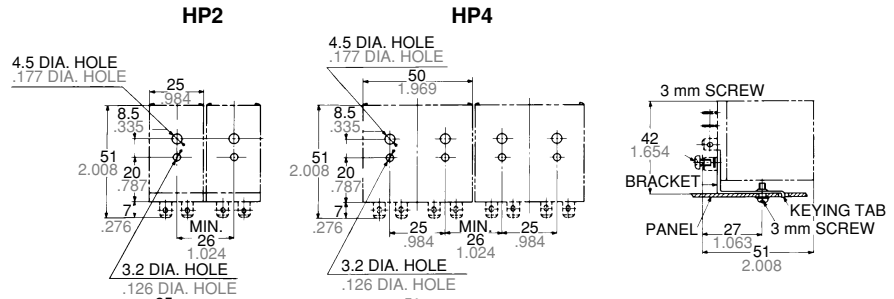

2. Front-surface mounting

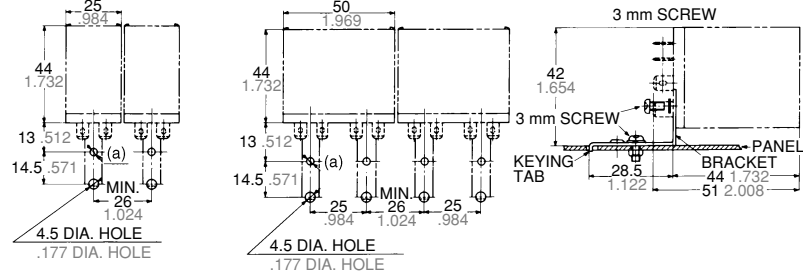

HP Inserting Plate for HP2 and HP4 types

1. HP inserting plate is used for mounting HP2 and HP4 relays on a printed board to adjust the length of the terminals.

2. If adjustment by soldering is not suitable, bore 1/8" diameter hole on the printed circuit board and mount the relay with a M3 × 10 screw. The chart to the right suggests the proper screws for different printed circuit boards.

3. Two plates are used for the HP4 type relay.

| Thickness of P/C board | Suitable screw |
|------------------------|----------------|
| 1.0 mm .039 inch | M3 × 10 |
| 1.2 mm .047 inch | M3 × 10 |

PC board pattern

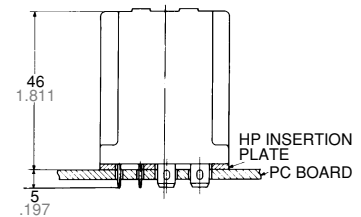
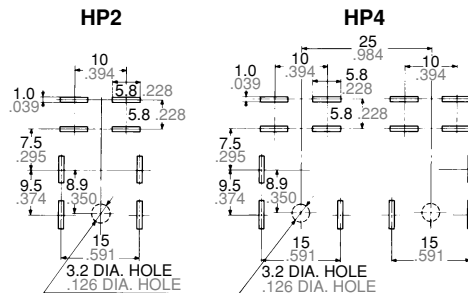
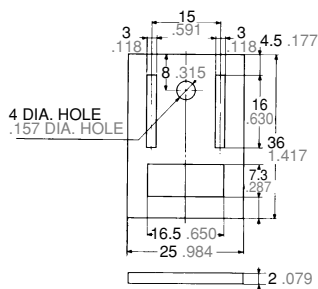

Please refer to the above second instruction.

Tolerance: ±0.1 ±0.04

For Cautions for Use, see Relay Technical Information