

## 阅读申明

- 1.本站收集的数据手册和产品资料都来自互联网，版权归原作者所有。如读者和版权方有任何异议请及时告之，我们将妥善解决。
- 2.本站提供的中文数据手册是英文数据手册的中文翻译，其目的是协助用户阅读，该译文无法自动跟随原稿更新，同时也可能存在翻译上的不当。建议读者以英文原稿为参考以便获得更精准的信息。
- 3.本站提供的产品资料，来自厂商的技术支持或者使用者的心得体会等，其内容可能存在描述上的差异，建议读者做出适当判断。
- 4.如需与我们联系，请发邮件到marketing@iczoom.com，主题请标有“数据手册”字样。

## Read Statement

1. The datasheets and other product information on the site are all from network reference or other public materials, and the copyright belongs to the original author and original published source. If readers and copyright owners have any objections, please contact us and we will deal with it in a timely manner.
2. The Chinese datasheets provided on the website is a Chinese translation of the English datasheets. Its purpose is for reader's learning exchange only and do not involve commercial purposes. The translation cannot be automatically updated with the original manuscript, and there may also be improper translations. Readers are advised to use the English manuscript as a reference for more accurate information.
3. All product information provided on the website refer to solutions from manufacturers' technical support or users the contents may have differences in description, and readers are advised to take the original article as the standard.
4. If you have any questions, please contact us at marketing@iczoom.com and mark the subject with "Datasheets" .

# Nais

## 6PDT FLATPACK 2AMP DIL RELAY

# NL-RELAYS

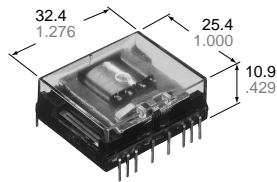

NLE Amber Relays

mm inch

### FEATURES

- Space saving dimensions — 25.4 mm × 32.4 mm × 10.9 mm  
1.000 inch × 1.276 inch × 0.429 inch
- Latching types available
- Low operating power — 400 mW (single side stable)  
Transistor compatible
- High breakdown voltage for transient protection — 1,000 Vrms between open contacts, contact sets, and 1,500 V FCC surge between open contacts
- Soldering flux inflow completely prevented

### SPECIFICATIONS

#### Contacts

Arrangement**1	6 Form C		
Contact material	gold-clad silver**2		
Initial contact resistance, max. (By voltage drop 6 V DC 1 A)	100 mΩ		
Rating (resistive)	Nominal switching capacity	2 A 30 V DC	
	Max. switching power	60 VA, 60 W	
	Max. switching voltage	125 V AC, 30 V DC	
	Max. switching current	2 A	
Expected life (min. operations)	Mechanical	5×10 <sup>7</sup>	
	Electrical (resistive)	2 A 30 V DC	5×10 <sup>5</sup>
		0.6 A 100 V DC	10 <sup>6</sup>

\*\*1 MBB contact types also available: 2 MBB, 4 MBB & 6 MBB

\*\*2 Gold capped silver-palladium contact also available

#### Coil (polarized) (at 25°C 77°F)

Minimum operating power	Approx. 460 mW
Nominal operating power	up to 60 V DC: Approx. 720 mW 110 V DC: Approx. 900 mW
Minimum set and reset power	Approx. 1,000 mW
Nominal set and reset power	Approx. 1,600 mW

#### Remarks

- \* Specifications will vary with foreign standards certification ratings.
- \*1 Measurement at same location as "Initial breakdown voltage" section
- \*2 Detection current: 10 mA
- \*3 Excluding contact bounce time
- \*4 Half-wave pulse of sine wave: 11ms; detection time: 10μs
- \*5 Half-wave pulse of sine wave: 6ms
- \*6 Detection time: 10μs
- \*7 Refer to 5. Conditions for operation, transport and storage mentioned in AMBIENT ENVIRONMENT (Page 61).

#### Characteristics

Maximum operating speed		50 cps
Initial insulation resistance*1		Min. 100 MΩ at 500 V DC
Breakdown voltage*2	Between open contacts, contact sets	1,000 Vrms
	Between contacts and coil	2,000 Vrms
Operate time*3 (at nominal voltage)		Max. 15 ms (Approx. 10 ms)
Release time (without diode)*3 (at nominal voltage)		Max. 10 ms (Approx. 5 ms)
Temperature rise		Max. 65°C with nominal coil voltage and at switching current 2 A
Shock resistance	Functional*4	Min. 147 m/s <sup>2</sup> {15 G}
	Destructive*5	Min. 980 m/s <sup>2</sup> {100 G}
Vibration resistance	Functional*6	58.8 m/s <sup>2</sup> {6 G}, 10 to 55 Hz at double amplitude of 1 mm
	Destructive	117.6 m/s <sup>2</sup> {12 G}, 10 to 55 Hz at double amplitude of 2 mm
Conditions for operation, transport and storage*7 (Not freezing and condensing at low temperature)	Ambient temp.	-40°C to +55°C -40°F to +131°F
	Humidity	5 to 85% R.H.
Unit weight		Approx. 17 g 60 oz

### TYPICAL APPLICATIONS

Telecommunications, security equipment, detection systems.

### ORDERING INFORMATION

Ex. NL 6 EB X 6M L2 DC48V 1

Contact arrangement	Classification of type	MBB function	Operating function	Coil voltage	Contact material
6: 6 Form C	EB: Amber sealed type	Nil: 6 Form C	Nil: Single side stable L2: 2 coil latching	DC: 5, 6, 12, 24, 48, 60, 110 V	Nil: Gold-clad silver 1: Gold-cap over silver palladium

- (Notes) 1. For UL/CSA or VDE recognized types, add suffix UL/CSA or VDE.  
2. Standard packing Carton: 20 pcs. Case: 200 pcs.

**TYPES AND COIL DATA (at 20°C 68°F)**

**Single side stable**

Part No.	Coil voltage, V DC			Coil resistance, Ω (±10%)	Nominal operating power, mW
	Pick-up (max.)	Drop-out (min.)	Maximum allowable		
NL6EBX-DC5V	4.0	0.5	6.0	34.7	720
NL6EBX-DC6V	4.8	0.6	7.2	50	
NL6EBX-DC12V	9.6	1.2	14.4	200	
NL6EBX-DC24V	19.2	2.4	28.8	800	
NL6EBX-DC48V	38.4	4.8	57.6	3,200	
NL6EBX-DC60V	48	6.0	72	5,000	
NL6EBX-DC110V	88	11.0	132	13,467	898

**2 coil latching**

Part No.	Coil voltage, * V DC			Coil resistance, Ω (±10%)	Nominal operating power, mW
	Set (max.)	Reset (max.)	Maximum allowable		
NL6EBX-L2-DC5V	4.0	4.0	5.5	15.6	1,600**
NL6EBX-L2-DC6V	4.8	4.8	6.6	22.5	
NL6EBX-L2-DC12V	9.6	9.6	13.2	90	
NL6EBX-L2-DC24V	19.2	19.2	26.4	360	
NL6EBX-L2-DC48V	38.4	38.4	52.8	1,440	
NL6EBX-L2-DC60V	48	48	66	2,250	
NL6EBX-L2-DC110V	88	88	121	7,563	

\* See NOTE 2

\*\* Two coil latching series are for intermittent operation only.

Power should be applied to coil continuously for no more than two minutes.

**DIMENSIONS**

mm inch

**Single side stable**

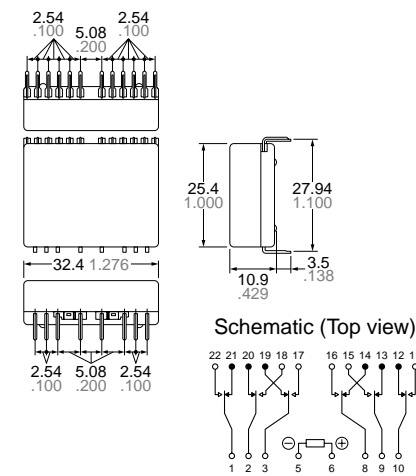

**PC board pattern (Bottom view)**

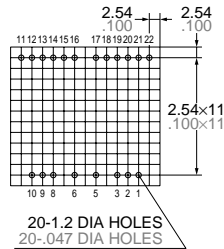

**2 coil latching**

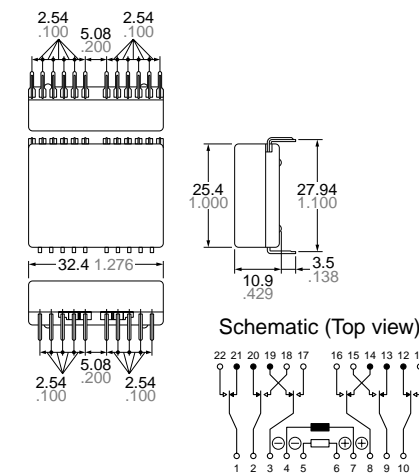

**PC board pattern (Bottom view)**

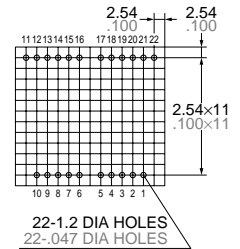

General tolerance: ±0.3 ±0.12

**REFERENCE DATA**

**1. Electrical life (2 A 30 V DC resistive load)**

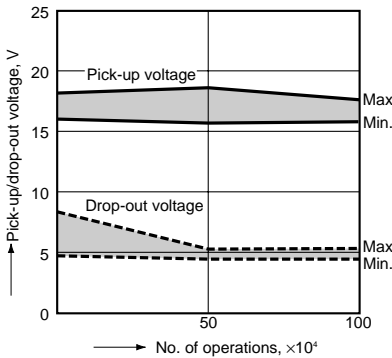

**2. Coil temperature rise**

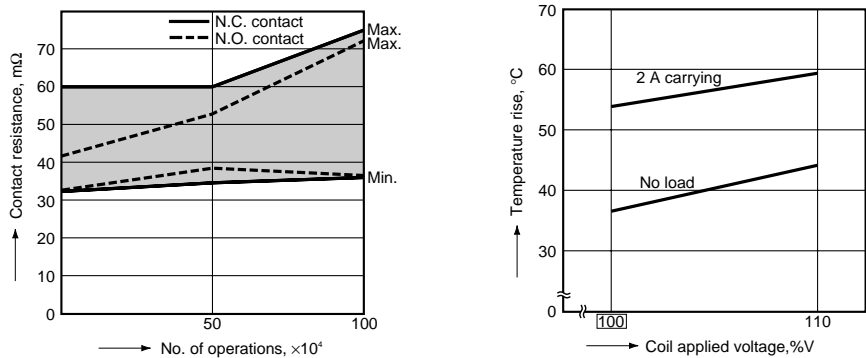

**NOTES**

**On two coil latching relays**

1. To maintain insulation between coils, terminals 6 and 7 should be connected to provide common return.

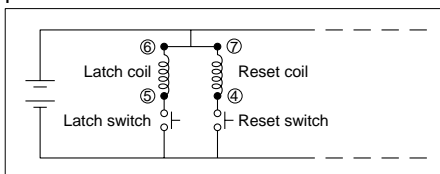

2. Two coil latching relays are for intermittent operation only. Power should be applied to coils for no more than two minutes; continuous operation may burn out the coils.

3. Position of MBB contacts  
 2M (2 Form D 4 Form C):  
 1-21-22, 10-11-12  
 4M (4 Form D 2 Form C):  
 1-21-22, 2-20-18, 9-13-15, 10-11-12

**For Cautions for Use, see Relay Technical Information**