

## 阅读申明

- 1.本站收集的数据手册和产品资料都来自互联网，版权归原作者所有。如读者和版权方有任何异议请及时告之，我们将妥善解决。
- 2.本站提供的中文数据手册是英文数据手册的中文翻译，其目的是协助用户阅读，该译文无法自动跟随原稿更新，同时也可能存在翻译上的不当。建议读者以英文原稿为参考以便获得更精准的信息。
- 3.本站提供的产品资料，来自厂商的技术支持或者使用者的心得体会等，其内容可能存在描述上的差异，建议读者做出适当判断。
- 4.如需与我们联系，请发邮件到marketing@iczoom.com，主题请标有“数据手册”字样。

## Read Statement

1. The datasheets and other product information on the site are all from network reference or other public materials, and the copyright belongs to the original author and original published source. If readers and copyright owners have any objections, please contact us and we will deal with it in a timely manner.
2. The Chinese datasheets provided on the website is a Chinese translation of the English datasheets. Its purpose is for reader's learning exchange only and do not involve commercial purposes. The translation cannot be automatically updated with the original manuscript, and there may also be improper translations. Readers are advised to use the English manuscript as a reference for more accurate information.
3. All product information provided on the website refer to solutions from manufacturers' technical support or users the contents may have differences in description, and readers are advised to take the original article as the standard.
4. If you have any questions, please contact us at marketing@iczoom.com and mark the subject with "Datasheets" .

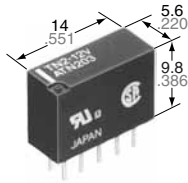

mm inch

### FEATURES

- Small header area makes higher density mounting possible
- High sensitivity: 140 mW nominal operating power (single side stable 3-12 V type)

- Surge voltage withstand: 1500 V FCC Part 68
- Self-clinching terminal also available

RoHS Directive compatibility information  
<http://www.nais-e.com/>

### SPECIFICATIONS

#### Contact

Arrangement	2 Form C	
Initial contact resistance, max. (By voltage drop 6 V DC 1A)	60 mΩ	
Contact material	Gold-clad silver	
Rating	Nominal switching capacity (resistive load)	1 A 30 V DC, 0.5 A 125 V AC
	Max. switching power (resistive load)	30 W, 62.5 VA
	Max. switching voltage	110 V DC, 125 V AC
	Max. switching current	1 A
	Min. switching capacity (Reference value) <sup>#1</sup>	10 μA 10 mV DC
Nominal operating power	Single side stable	140 mW (3 to 12 V DC) 200 mW (24 V DC) 300 mW (48 V DC)
	1 coil latching	100 mW (3 to 12 V DC) 150 mW (24 V DC)
	2 coil latching	200 mW (3 to 12 V DC) 300 mW (24 V DC)
Expected life (min. operations)	Mechanical (at 180 cpm)	10 <sup>8</sup>
	Electrical (at 20 cpm)	1 A 30 V DC resistive load: 2 × 10 <sup>5</sup> 0.5 A 125 V AC resistive load: 10 <sup>5</sup>

#### Note:

#1 This value can change due to the switching frequency, environmental conditions, and desired reliability level, therefore it is recommended to check this with the actual load. (SX relays are available for low level load switching [10V DC, 10mA max. level])

#### Remarks

- \* Specifications will vary with foreign standards certification ratings.
- \*1 Measurement at same location as "Initial breakdown voltage" section.
- \*2 By resistive method, nominal voltage applied to the coil; contact carrying current: 1 A.
- \*3 Nominal voltage applied to the coil, excluding contact bounce time.
- \*4 Nominal voltage applied to the coil, excluding contact bounce time without diode.

#### Characteristics

Initial insulation resistance*1		Min. 1,000 MΩ (at 500 V DC)
Initial breakdown voltage	Between open contacts	750 Vrms for 1 min. (Detection current: 10 mA)
	Between contact and coil	1,000 Vrms for 1 min. (Detection current: 10 mA)
	Between contact sets	1,000 Vrms for 1 min. (Detection current: 10 mA)
FCC surge voltage between open contacts		1,500 V
Temperature rise*2 (at 20°C)		Max. 50°C
Operate time [Set time]*3 (at 20°C)		Max. 3 ms [Max. 3 ms]
Release time [Reset time]*4 (at 20°C)		Max. 3 ms [Max. 3 ms]
Shock resistance	Functional*5	Min. 490 m/s <sup>2</sup> {50G}
	Destructive*6	Min. 980 m/s <sup>2</sup> {100G}
Vibration resistance	Functional*7	176.4 m/s <sup>2</sup> {18G}, 10 to 55 Hz at double amplitude of 3 mm
	Destructive	294 m/s <sup>2</sup> {30G}, 10 to 55 Hz at double amplitude of 5 mm
Conditions for operation, transport and storage*8 (Not freezing and condensing at low temperature)	Ambient temperature	-40°C to +70°C -40°F to +158°F
	Humidity	5 to 85% R.H.
Unit weight		Approx. 1.5 g .053 oz

\*5 Half-wave pulse of sine wave: 11 ms; detection time: 10 μs.

\*6 Half-wave pulse of sine wave: 6 ms.

\*7 Detection time: 10 μs.

\*8 Refer to 6. Conditions for operation, transport and storage mentioned in AMBIENT ENVIRONMENT .

**ORDERING INFORMATION**

Ex. TN 2 — L2 — H — 12V

Contact arrangement	Operating function	Terminal shape	Coil voltage(DC)
2: 2 Form C	Nil: Single side stable L: 1 coil latching L2: 2 coil latching	Nil: Standard PC board terminal H: Self-clinching terminal	3,4.5,5,6,9,12, 24,48*V

\*48 V coil type: Single side stable only

Note: AgPd stationary contact types available for high resistance against contact sticking.

When ordering, please add suffix “-3” like TN2-12V-3.

**TYPES AND COIL DATA (at 20°C 68°F)**

**1. Single side stable**

Part No.		Nominal voltage, V DC	Pick-up voltage, V DC (max.)	Drop-out voltage, V DC (min.)	Nominal operating current, mA (±10%)	Coil resistance, Ω (±10%)	Nominal operating power, mW	Max. allowable voltage, V DC
Standard PC board terminal	Self-clinching terminal							
TN2-3 V	TN2-H-3 V	3	2.25	0.3	46.7	64.3	140	4.5
TN2-4.5 V	TN2-H-4.5 V	4.5	3.38	0.45	31.1	145	140	6.7
TN2-5 V	TN2-H-5 V	5	3.75	0.5	28.1	178	140	7.5
TN2-6 V	TN2-H-6 V	6	4.5	0.6	23.3	257	140	9
TN2-9 V	TN2-H-9 V	9	6.75	0.9	15.5	579	140	13.5
TN2-12 V	TN2-H-12 V	12	9	1.2	11.7	1,028	140	18
TN2-24 V	TN2-H-24 V	24	18	2.4	8.3	2,880	200	36
TN2-48 V	TN2-H-48 V	48	36	4.8	6.25	7,680	300	57.6

**2. 1 Coil latching**

Part No.		Nominal voltage, V DC	Set voltage, V DC (max.)	Reset voltage, V DC (max.)	Nominal operating current, mA (±10%)	Coil resistance, Ω (±10%)	Nominal operating power, mW	Max. allowable voltage, V DC
Standard PC board terminal	Self-clinching terminal							
TN2-L-3 V	TN2-L-H-3 V	3	2.25	2.25	33.3	90	100	4.5
TN2-L-4.5 V	TN2-L-H-4.5 V	4.5	3.38	3.38	22.2	202.5	100	6.7
TN2-L-5 V	TN2-L-H-5 V	5	3.75	3.75	20	250	100	7.5
TN2-L-6 V	TN2-L-H-6 V	6	4.5	4.5	16.7	360	100	9
TN2-L-9 V	TN2-L-H-9 V	9	6.75	6.75	11.1	810	100	13.5
TN2-L-12 V	TN2-L-H-12 V	12	9	9	8.3	1,440	100	18
TN2-L-24 V	TN2-L-H-24 V	24	18	18	6.3	3,840	150	36

**3. 2 Coil latching**

Part No.		Nominal voltage, V DC	Set voltage, V DC (max.)	Reset voltage, V DC (max.)	Nominal operating current, mA (±10%)	Coil resistance, Ω (±10%)	Nominal operating power, mW	Max. allowable voltage, V DC
Standard PC board terminal	Self-clinching terminal							
TN2-L2-3 V	TN2-L2-H-3 V	3	2.25	2.25	66.7	45	200	4.5
TN2-L2-4.5 V	TN2-L2-H-4.5 V	4.5	3.38	3.38	44.4	101.2	200	6.7
TN2-L2-5 V	TN2-L2-H-5 V	5	3.75	3.75	40	125	200	7.5
TN2-L2-6 V	TN2-L2-H-6 V	6	4.5	4.5	33.3	180	200	9
TN2-L2-9 V	TN2-L2-H-9 V	9	6.75	6.75	22.2	405	200	13.5
TN2-L2-12 V	TN2-L2-H-12 V	12	9	9	16.7	720	200	18
TN2-L2-24 V	TN2-L2-H-24 V	24	18	18	12.5	1,920	300	28.8

**Notes:**

1. Specified value of the pick-up, drop-out, set and reset voltage is with the condition of square wave coil pulse.
2. Standard packing: Tube: 50 pcs.; Case: 1,000 pcs.
3. In case of 5 V drive circuit, it is recommended to use 4.5 V type relay.
4. AgPd stationary contact types available for high resistance against contact sticking. When ordering, please add suffix "-3" like TN2-12V-3.

# DIMENSIONS



Standard PC board terminal

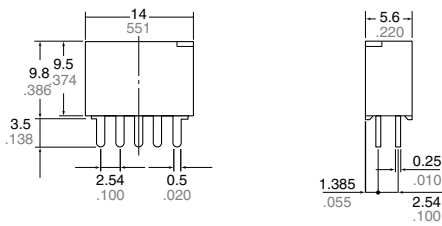

PC board pattern (Copper-side view)

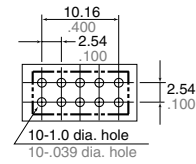

Tolerance:  $\pm 0.1 \pm .004$

Self-clinching terminal

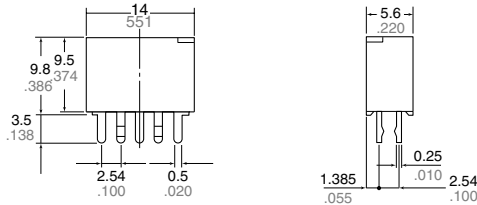

General tolerance:  $\pm 0.3 \pm .012$

Schematic (Bottom view)

• Single side stable (Deenergized condition)

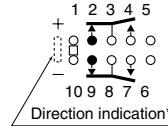

• 1-coil latching (Reset condition)

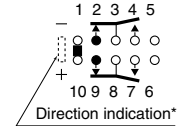

• 2-coil latching (Reset condition)

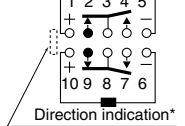

\*Orientation stripe located on top of relay

# REFERENCE DATA

## 1. Maximum switching capacity

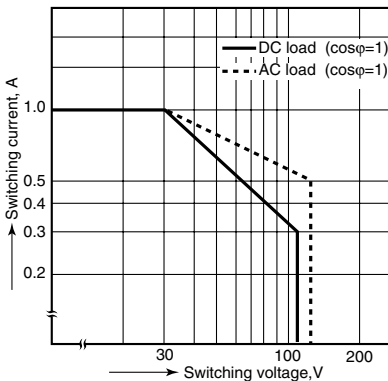

## 2. Life curve

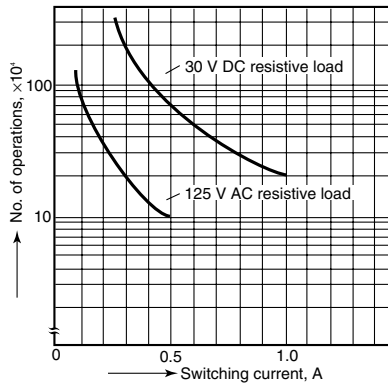

## 3. Mechanical life

Tested sample: TN2-12V, 10 pcs.

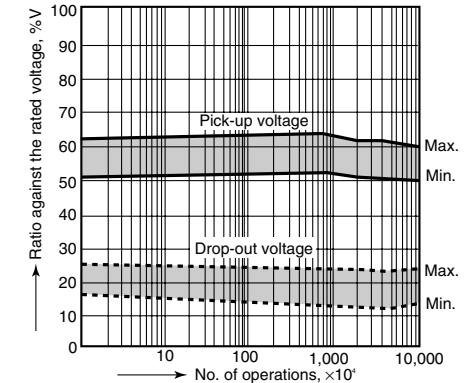

## 4. Electrical life (DC load)

Tested sample: TN2-12V, 10 pcs.

Condition: 1 A 30 V DC resistive load, 20 cpm

Change of pick-up and drop-out voltage

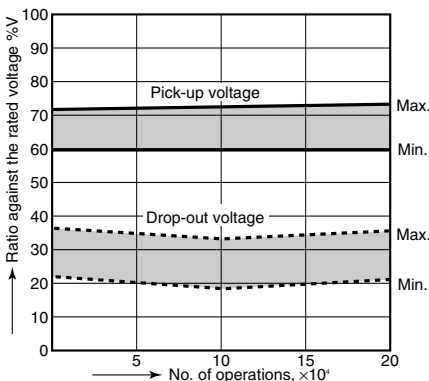

Change of contact resistance

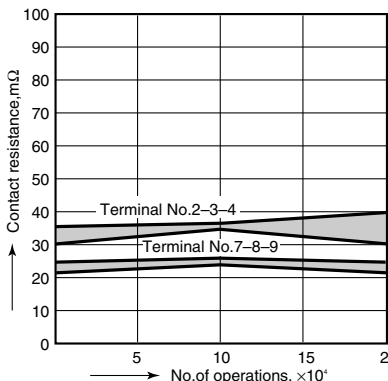

## 5. Coil temperature rise

Tested sample: TN2-12V

Point measured: Inside the coil

Ambient temperature: Room temperature (25° to 26°C), 70°C (77° to 79°F), 158°F

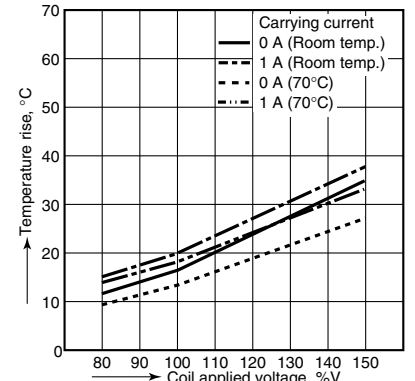

6. Operate/release time characteristics

Tested sample: TN2-12V, 5 pcs.

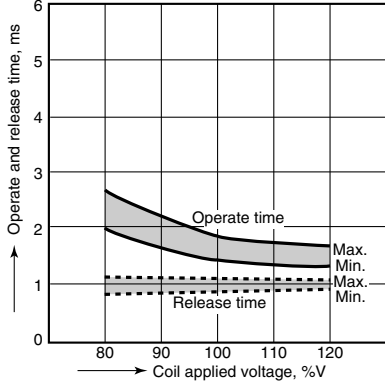

7. Set/reset time characteristics

Tested sample: TN2-L2-12V, 5 pcs.

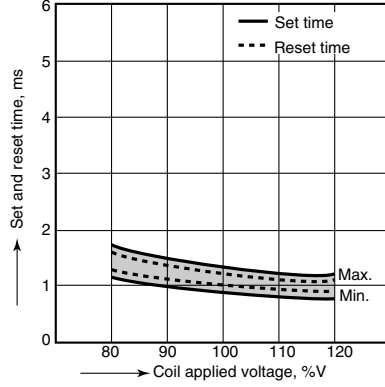

8. Distribution of pick-up and drop-out voltages

Tested sample: TN2-12V, 40 pcs.

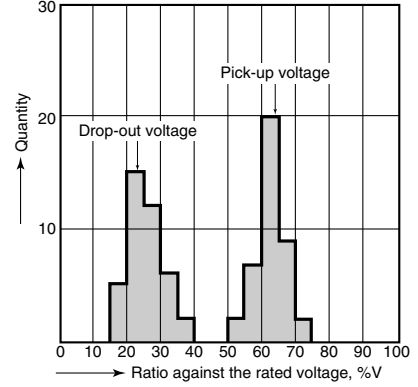

9. Distribution of set and reset voltage

Tested sample: TN2-L2-12V, 32 pcs.

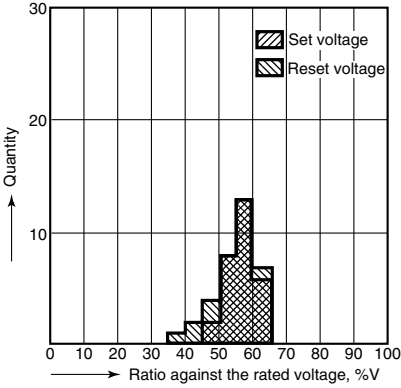

10. Ambient temperature characteristics

Tested sample: TN2-12V, 5 pcs.

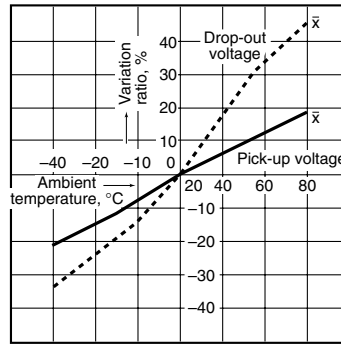

11. Distribution of contact resistance

Tested sample: TN2-12V, 38 pcs. (38x4 contacts)

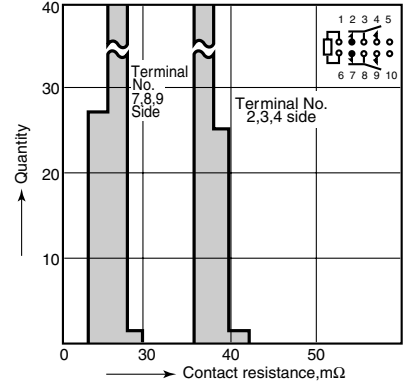

12-(1). Malfunctional shock (single side stable)

Tested sample: TN2-12V, 6 pcs.

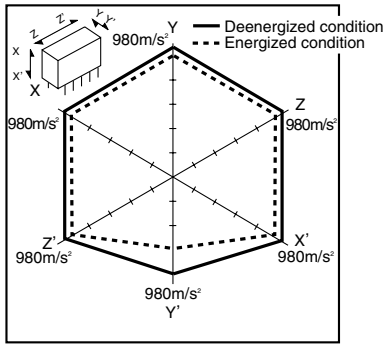

12-(2). Malfunctional shock (latching)

Tested sample: TN2-L2-12V, 6 pcs.

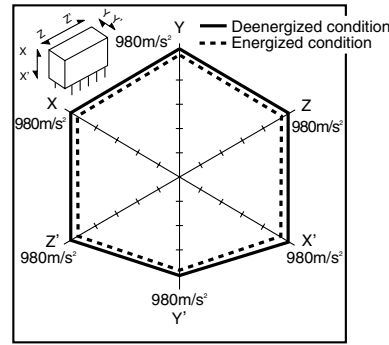

13-(1). Influence of adjacent mounting

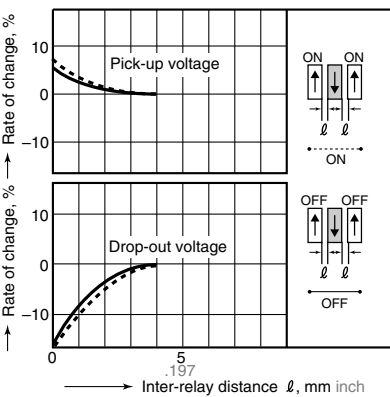

13-(2). Influence of adjacent mounting

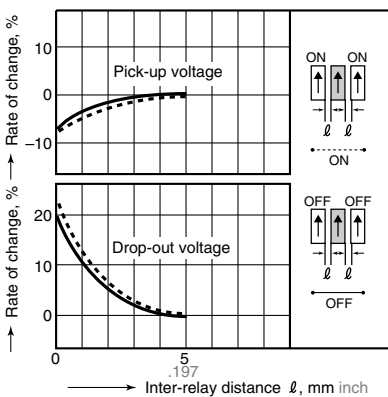

14. Actual load test  
(35 mA 48 V DC wire spring relay load)

Circuit

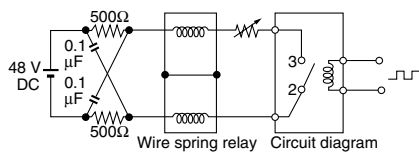

Change of pick-up and drop-out voltage

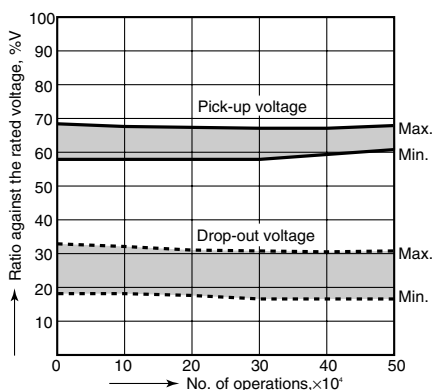

Change of contact resistance

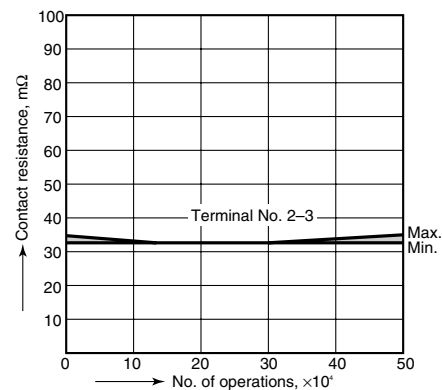

15-(1). High-frequency characteristics

Tested sample: TN2-xxV  
Isolation characteristics

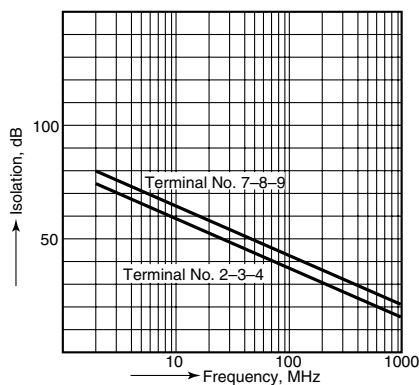

15-(2). High-frequency characteristics

Tested sample: TN2-xxV  
Insertion loss characteristics

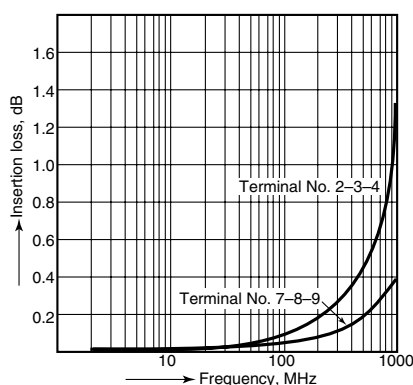

15-(3). High-frequency characteristics

Tested sample: TN2-xxV  
V.S.W.R.

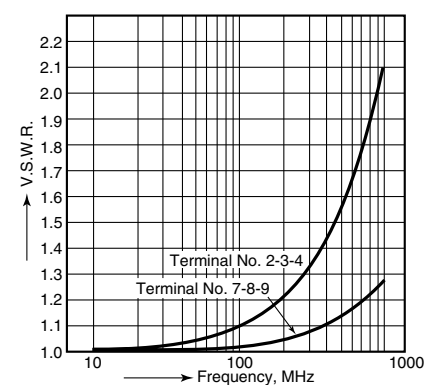

**For Cautions for Use, see Relay Technical Information.**