

阅读申明

- 1.本站收集的数据手册和产品资料都来自互联网，版权归原作者所有。如读者和版权方有任何异议请及时告之，我们将妥善解决。
- 2.本站提供的中文数据手册是英文数据手册的中文翻译，其目的是协助用户阅读，该译文无法自动跟随原稿更新，同时也可能存在翻译上的不当。建议读者以英文原稿为参考以便获得更精准的信息。
- 3.本站提供的产品资料，来自厂商的技术支持或者使用者的心得体会等，其内容可能存在描述上的差异，建议读者做出适当判断。
- 4.如需与我们联系，请发邮件到marketing@iczoom.com，主题请标有“数据手册”字样。

Read Statement

1. The datasheets and other product information on the site are all from network reference or other public materials, and the copyright belongs to the original author and original published source. If readers and copyright owners have any objections, please contact us and we will deal with it in a timely manner.
2. The Chinese datasheets provided on the website is a Chinese translation of the English datasheets. Its purpose is for reader's learning exchange only and do not involve commercial purposes. The translation cannot be automatically updated with the original manuscript, and there may also be improper translations. Readers are advised to use the English manuscript as a reference for more accurate information.
3. All product information provided on the website refer to solutions from manufacturers' technical support or users the contents may have differences in description, and readers are advised to take the original article as the standard.
4. If you have any questions, please contact us at marketing@iczoom.com and mark the subject with "Datasheets" .

Panasonic

ideas for life

New pin layout (LT type) added. Best seller with broad lineup and AC 2000 V breakdown voltage.

TX RELAYS

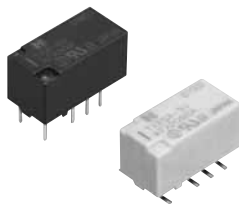

Compliance with RoHS Directive

FEATURES

1. 2,000 V breakdown voltage between contact and coil

The body block construction of the coil that is sealed at formation offers a high breakdown voltage of 2,000 V between contact and coil, and 1,000 V between open contacts.

2. Outstanding surge resistance.

Surge breakdown voltage between open contacts:
1,500 V 10×160μ sec. (FCC part 68)
Surge breakdown voltage between contact and coil:
2,500 V 2×10μ sec. (Bellcore)

3. Nominal operating power: High sensitivity of 140mW

By using the highly efficient polar magnetic circuit "seesaw balance mechanism", a nominal operating power of 140 mW (minimum operating power of 79 mW) has been achieved.

4. High contact capacity: 2 A 30 V DC

5. Compact size

15.0(L) × 7.4(W) × 8.2(H) .591(L) × .291(W) × .323(H)

6. The use of gold-clad twin crossbar contacts ensures high contact reliability.

*We also offer a range of products with AgPd contacts suitable for use in low level load analog circuits (Max. 10V DC 10 mA).

*SX relays designed for low level loads are also available.

7. Outstanding vibration and shock resistance.

Functional shock resistance: 750 m/s²
Destructive shock resistance: 1,000 m/s²
Functional vibration resistance: 10 to 55 Hz (at double amplitude of 3.3 mm .130 inch)

Destructive vibration resistance:

10 to 55 Hz (at double amplitude of 5 mm .197 inch)

8. Sealed construction allows automatic washing.

9. A range of surface-mount types is also available

SA: Low-profile surface-mount terminal type

SL: High connection reliability surface-mount terminal type 

SS: Space saving surface-mount terminal type

TYPICAL APPLICATIONS

1. Communications (xDSL, Transmission)
2. Measurement
3. Security
4. Home appliances, and audio/visual equipment
5. Automotive equipment
6. Medical equipment

ORDERING INFORMATION

Contact arrangement
2: 2 Form C

Surface-mount availability
Nil: Standard PC board terminal type or self-clinching terminal type 

SA: SA type
SL: SL type 
SS: SS type

Operating function
Nil: Single side stable
L: 1 coil latching
L2: 2 coil latching
LT: 2 coil latching

Terminal shape
Nil: Standard PC board terminal or surface-mount terminal
H: Self-clinching terminal 

Nominal coil voltage (DC)*
1.5, 3, 4.5, 5, 6, 9, 12, 24, 48V

Contact material
Nil: Standard contact (Ag+Au clad)
1: AgPd contact (low level load); AgPd+Au clad (stationary), AgPd (movable)

Packing style
Nil: Tube packing
X: Tape and reel (picked from 1/3/4/5-pin side)
Z: Tape and reel packing (picked from the 8/9/10/12-pin side)

Notes: 1. *48 V coil type: Single side stable only
2. In case of 5 V transistor drive circuit, it is recommended to use 4.5 V type relay.

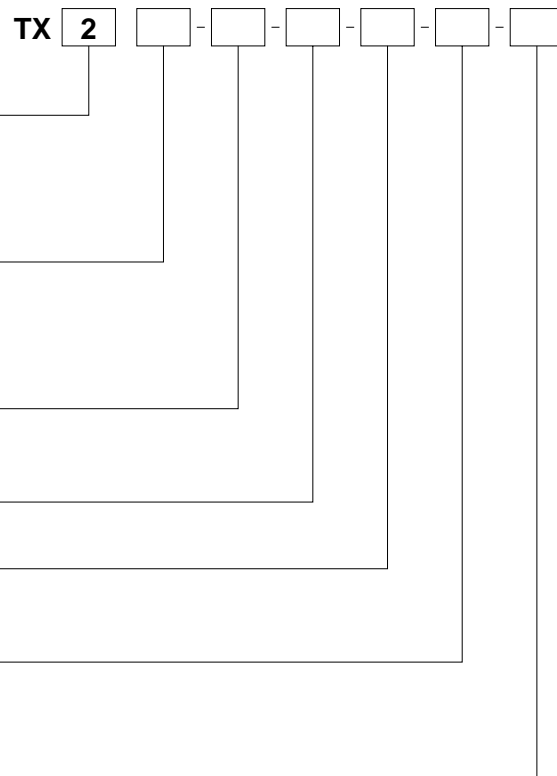



TYPES

1. Standard PC board terminal

Contact arrangement	Nominal coil voltage	Single side stable	1 coil latching	2 coil latching (L2)	2 coil latching (LT)
		Part No.	Part No.	Part No.	Part No.
2 Form C	1.5V DC	TX2-1.5V	TX2-L-1.5V	TX2-L2-1.5V	TX2-LT-1.5V
	3V DC	TX2-3V	TX2-L-3V	TX2-L2-3V	TX2-LT-3V
	4.5V DC	TX2-4.5V	TX2-L-4.5V	TX2-L2-4.5V	TX2-LT-4.5V
	5V DC	TX2-5V	TX2-L-5V	TX2-L2-5V	TX2-LT-5V
	6V DC	TX2-6V	TX2-L-6V	TX2-L2-6V	TX2-LT-6V
	9V DC	TX2-9V	TX2-L-9V	TX2-L2-9V	TX2-LT-9V
	12V DC	TX2-12V	TX2-L-12V	TX2-L2-12V	TX2-LT-12V
	24V DC	TX2-24V	TX2-L-24V	TX2-L2-24V	TX2-LT-24V
	48V DC	TX2-48V	—	—	—

Standard packing: Tube: 40 pcs.; Case: 1,000 pcs.

Note: Please add "-1" to the end of the part number for AgPd contacts (low level load).

2. self-clinching terminal

Contact arrangement	Nominal coil voltage	Single side stable	1 coil latching	2 coil latching (L2)	2 coil latching (LT)
		Part No.	Part No.	Part No.	Part No.
2 Form C	1.5V DC	TX2-H-1.5V	TX2-L-H-1.5V	TX2-L2-H-1.5V	TX2-LT-H-1.5V
	3V DC	TX2-H-3V	TX2-L-H-3V	TX2-L2-H-3V	TX2-LT-H-3V
	4.5V DC	TX2-H-4.5V	TX2-L-H-4.5V	TX2-L2-H-4.5V	TX2-LT-H-4.5V
	5V DC	TX2-H-5V	TX2-L-H-5V	TX2-L2-H-5V	TX2-LT-H-5V
	6V DC	TX2-H-6V	TX2-L-H-6V	TX2-L2-H-6V	TX2-LT-H-6V
	9V DC	TX2-H-9V	TX2-L-H-9V	TX2-L2-H-9V	TX2-LT-H-9V
	12V DC	TX2-H-12V	TX2-L-H-12V	TX2-L2-H-12V	TX2-LT-H-12V
	24V DC	TX2-H-24V	TX2-L-H-24V	TX2-L2-H-24V	TX2-LT-H-24V
	48V DC	TX2-H-48V	—	—	—

Standard packing: Tube: 40 pcs.; Case: 1,000 pcs.

Note: Please add "-1" to the end of the part number for AgPd contacts (low level load).

3. Surface-mount terminal

1) Tube packing

Contact arrangement	Nominal coil voltage	Single side stable	1 coil latching	2 coil latching (L2)	2 coil latching (LT)
		Part No.	Part No.	Part No.	Part No.
2c	1.5V DC	TX2S□-1.5V	TX2S□-L-1.5V	TX2S□-L2-1.5V	TX2S□-LT-1.5V
	3V DC	TX2S□-3V	TX2S□-L-3V	TX2S□-L2-3V	TX2S□-LT-3V
	4.5V DC	TX2S□-4.5V	TX2S□-L-4.5V	TX2S□-L2-4.5V	TX2S□-LT-4.5V
	5V DC	TX2S□-5V	TX2S□-L-5V	TX2S□-L2-5V	TX2S□-LT-5V
	6V DC	TX2S□-6V	TX2S□-L-6V	TX2S□-L2-6V	TX2S□-LT-6V
	9V DC	TX2S□-9V	TX2S□-L-9V	TX2S□-L2-9V	TX2S□-LT-9V
	12V DC	TX2S□-12V	TX2S□-L-12V	TX2S□-L2-12V	TX2S□-LT-12V
	24V DC	TX2S□-24V	TX2S□-L-24V	TX2S□-L2-24V	TX2S□-LT-24V
		48V DC	TX2S□-48V	—	—

□: For each surface-mounted terminal identification, input the following letter. SA type: A, SL type: L, SS type: S

Standard packing: Tube: 40 pcs.; Case: 1,000 pcs.

Note: Please add "-1" to the end of the part number for AgPd contacts (low level load).

2) Tape and reel packing

Contact arrangement	Nominal coil voltage	Single side stable	1 coil latching	2 coil latching (L2)	2 coil latching (LT)
		Part No.	Part No.	Part No.	Part No.
2 Form C	1.5V DC	TX2S□-1.5V-Z	TX2S□-L-1.5V-Z	TX2S□-L2-1.5V-Z	TX2S□-LT-1.5V-Z
	3V DC	TX2S□-3V-Z	TX2S□-L-3V-Z	TX2S□-L2-3V-Z	TX2S□-LT-3V-Z
	4.5V DC	TX2S□-4.5V-Z	TX2S□-L-4.5V-Z	TX2S□-L2-4.5V-Z	TX2S□-LT-4.5V-Z
	5V DC	TX2S□-5V-Z	TX2S□-L-5V-Z	TX2S□-L2-5V-Z	TX2S□-LT-5V-Z
	6V DC	TX2S□-6V-Z	TX2S□-L-6V-Z	TX2S□-L2-6V-Z	TX2S□-LT-6V-Z
	9V DC	TX2S□-9V-Z	TX2S□-L-9V-Z	TX2S□-L2-9V-Z	TX2S□-LT-9V-Z
	12V DC	TX2S□-12V-Z	TX2S□-L-12V-Z	TX2S□-L2-12V-Z	TX2S□-LT-12V-Z
	24V DC	TX2S□-24V-Z	TX2S□-L-24V-Z	TX2S□-L2-24V-Z	TX2S□-LT-24V-Z
	48V DC	TX2S□-48V-Z	—	—	—

Standard packing: Tape and reel: 500 pcs.; Case: 1,000 pcs.

Notes: 1. Tape and reel packing symbol "-Z" is not marked on the relay. "X" type tape and reel packing (picked from 1/2/3/4-pin side) is also available.

2. Please add "-1" to the end of the part number for AgPd contacts (low level load).

**RATING****1. Coil data**

1) Single side stable

Nominal coil voltage	Pick-up voltage (at 20°C 68°F)	Drop-out voltage (at 20°C 68°F)	Nominal operating current [±10%] (at 20°C 68°F)	Coil resistance [±10%] (at 20°C 68°F)	Nominal operating power	Max. applied voltage (at 20°C 68°F)
1.5V DC	75%V or less of nominal voltage* (Initial)	10%V or more of nominal voltage* (Initial)	93.8mA	16Ω	140mW	150%V of nominal voltage
3V DC			46.7mA	64.3Ω		
4.5V DC			31mA	145Ω		
5V DC			28.1mA	178Ω		
6V DC			23.3mA	257Ω		
9V DC			15.5mA	579Ω		
12V DC			11.7mA	1,028Ω		
24V DC			5.8mA	4,114Ω		
48V DC			5.6mA	8,533Ω	270mW	

2) 1 coil latching

Nominal coil voltage	Set voltage (at 20°C 68°F)	Reset voltage (at 20°C 68°F)	Nominal operating current [±10%] (at 20°C 68°F)	Coil resistance [±10%] (at 20°C 68°F)	Nominal operating power	Max. applied voltage (at 20°C 68°F)
1.5V DC	75%V or less of nominal voltage* (Initial)	75%V or less of nominal voltage* (Initial)	66.7mA	22.5Ω	100mW	150%V of nominal voltage
3V DC			33.3mA	90Ω		
4.5V DC			22.2mA	202.5Ω		
5V DC			20mA	250Ω		
6V DC			16.7mA	360Ω		
9V DC			11.1mA	810Ω		
12V DC			8.3mA	1,440Ω		
24V DC			4.2mA	5,760Ω		

3) 2 coil latching (L2, LT)

Nominal coil voltage	Set voltage (at 20°C 68°F)	Reset voltage (at 20°C 68°F)	Nominal operating current [±10%] (at 20°C 68°F)		Coil resistance [±10%] (at 20°C 68°F)		Nominal operating power		Max. applied voltage (at 20°C 68°F)
			Set coil	Reset coil	Set coil	Reset coil	Set coil	Reset coil	
1.5V DC	75%V or less of nominal voltage* (Initial)	75%V or less of nominal voltage* (Initial)	133.9mA	133.9mA	11.2Ω	11.2Ω	200mW	200mW	150%V of nominal voltage
3V DC			66.7mA	66.7mA	45Ω	45Ω			
4.5V DC			44.5mA	44.5mA	101.2Ω	101.2Ω			
5V DC			40mA	40mA	125Ω	125Ω			
6V DC			33.3mA	33.3mA	180Ω	180Ω			
9V DC			22.2mA	22.2mA	405Ω	405Ω			
12V DC			16.7mA	16.7mA	720Ω	720Ω			
24V DC			8.3mA	8.3mA	2,880Ω	2,880Ω			

*Pulse drive (JIS C 5442-1986)



2. Specifications

Characteristics	Item	Specifications	
Contact	Arrangement	2 Form C	
	Initial contact resistance, max.	Max. 100 mΩ (By voltage drop 6 V DC 1A)	
	Contact material	Standard contact: Ag+Au clad, AgPd contact (low level load): AgPd+Au clad (stationary), AgPd (movable)	
Rating	Nominal switching capacity	Standard contact: 2 A 30 V DC, AgPd contact: 1 A 30 V DC (resistive load)	
	Max. switching power	Standard contact: 60 W (DC), AgPd contact: 30 W (DC) (resistive load)	
	Max. switching voltage	220V DC	
	Max. switching current	Standard contact: 2 A, AgPd contact: 1 A	
	Min. switching capacity (Reference value)*1	10μA 10mV DC	
	Nominal operating power	Single side stable	140 mW (1.5 to 24 V DC), 270 mW (48 V DC)
		1 coil latching	100 mW (1.5 to 24 V DC)
2 coil latching		200 mW (1.5 to 24 V DC)	
Electrical characteristics	Insulation resistance (Initial)	Min. 1,000MΩ (at 500V DC) Measurement at same location as "Initial breakdown voltage" section.	
	Breakdown voltage (Initial)	Between open contacts	1,000 Vrms for 1min. (Detection current: 10mA)
		Between contact and coil	2,000 Vrms for 1min. (Detection current: 10mA)
		Between contact sets	1,000 Vrms for 1min. (Detection current: 10mA)
	Surge breakdown voltage (Initial)	Between open contacts	1,500 V (10×160μs) (FCC Part 68)
		Between contacts and coil	2,500 V (2×10μs) (Telcordia)
	Temperature rise (at 20°C 68°F)	Max. 50°C (By resistive method, nominal coil voltage applied to the coil; contact carrying current: 2A.)	
	Operate time [Set time] (at 20°C 68°F)	Max. 4 ms [Max. 4 ms] (Nominal coil voltage applied to the coil, excluding contact bounce time.)	
Release time [Reset time] (at 20°C 68°F)	Max. 4 ms [Max. 4 ms] (Nominal coil voltage applied to the coil, excluding contact bounce time.) (without diode)		
Mechanical characteristics	Shock resistance	Functional	Min. 750 m/s ² (Half-wave pulse of sine wave: 6 ms; detection time: 10μs.)
		Destructive	Min. 1,000 m/s ² (Half-wave pulse of sine wave: 6 ms.)
	Vibration resistance	Functional	10 to 55 Hz at double amplitude of 3.3 mm (Detection time: 10μs.)
		Destructive	10 to 55 Hz at double amplitude of 5 mm
Expected life	Mechanical	Min. 10 ⁸ (at 180 cpm)	
	Electrical	Min. 10 ⁵ (2 A 30 V DC resistive), 5×10 ⁵ (1 A 30 V DC resistive) (at 20 cpm)	
Conditions	Conditions for operation, transport and storage*2	Ambient temperature: -40°C to +85°C (up to 24 V coil) -40°F to +185°F (up to 24 V coil) [-40°C to +70°C (48 V coil) -40°F to +158°F (48 V coil)]; Humidity: 5 to 85% R.H. (Not freezing and condensing at low temperature)	
	Max. operating speed (at rated load)	20 cpm	
Unit weight		Approx. 2 g .071 oz	

Notes: *1 This value can change due to the switching frequency, environmental conditions, and desired reliability level, therefore it is recommended to check this with the actual load. (AgPd contact type is available for low level load switching [10V DC, 10mA max. level])
*2 Refer to 6. Conditions for operation, transport and storage mentioned in AMBIENT ENVIRONMENT.

REFERENCE DATA

1. Maximum switching capacity

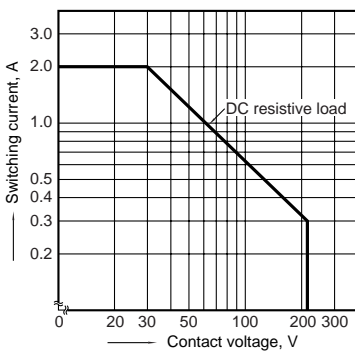

2. Life curve

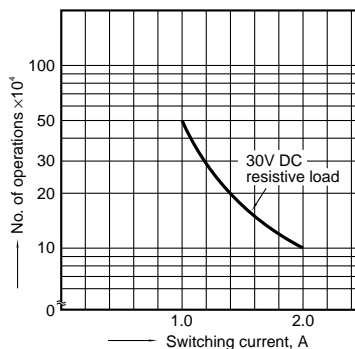

3. Mechanical life

Tested sample: TX2-5V, 10 pcs.
Operating speed: 180 cpm

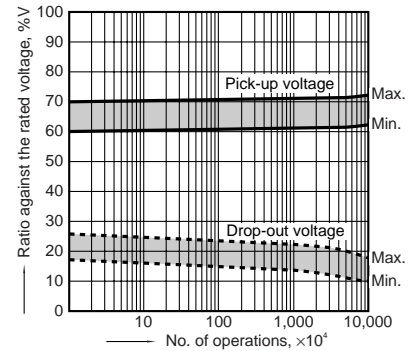

4. Electrical life (2A 30V DC resistive load)

Tested sample: TX2-5V, 6 pcs.
Operating speed: 20 cpm

Change of pick-up and drop-out voltage

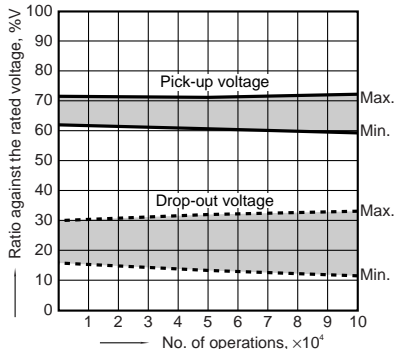

Change of contact resistance

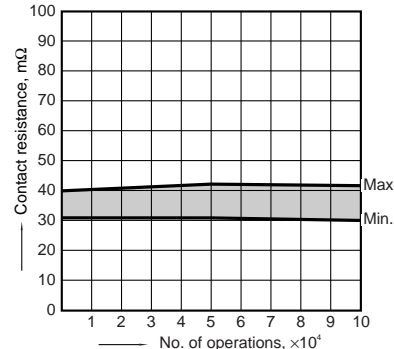

5-(1). Coil temperature rise

Tested sample: TX2-5V, 6 pcs.
Point measured: Inside the coil
Ambient temperature: 25°C 77°F, 85°C 185°F

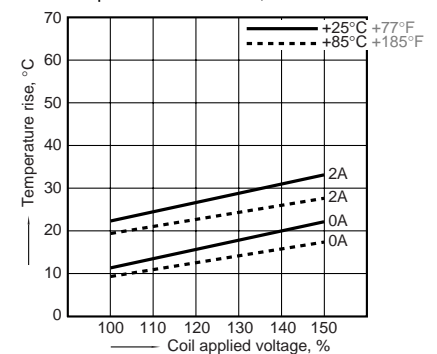



5-(2). Coil temperature rise

Tested sample: TX2-48V, 6 pcs.
Point measured: Inside the coil
Ambient temperature: 25°C 77°F, 70°C 158°F

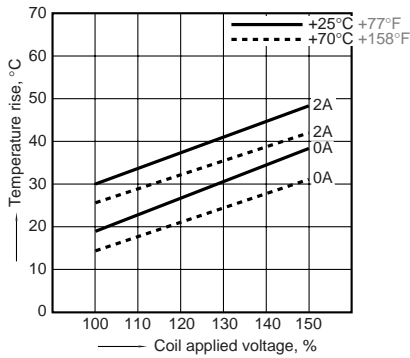

6-(1). Operate and release time (with diode)

Tested sample: TX2-5V, 10 pcs.

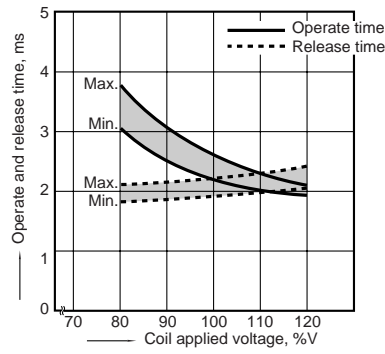

6-(2). Operate and release time (without diode)

Tested sample: TX2-5V, 10 pcs.

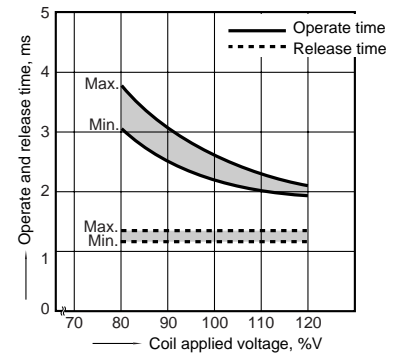

7. Ambient temperature characteristics

Tested sample: TX2-5V, 5 pcs.

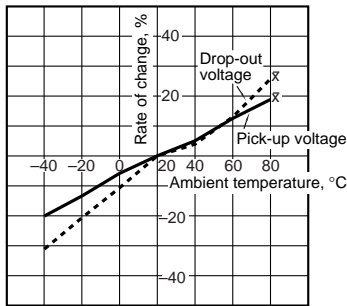

8-(1). High frequency characteristics (Isolation)

Tested sample: TX2-12V, 2 pcs.

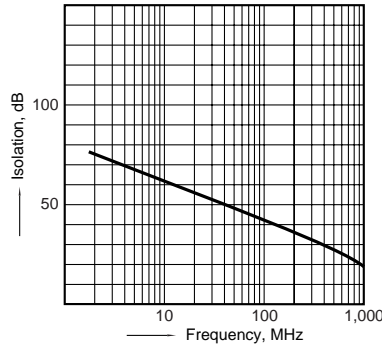

8-(2). High frequency characteristics (Insertion loss)

Tested sample: TX2-12V, 2 pcs.

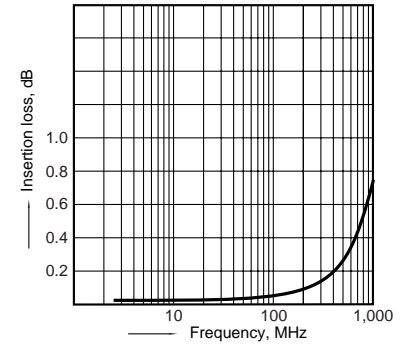

9 Malfunctional shock (single side stable)

Tested sample: TX2-5V, 6 pcs.

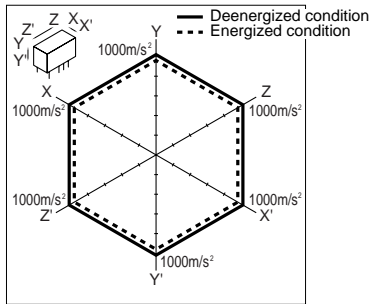

10-(1). Influence of adjacent mounting

Tested sample: TX2-12V, 6 pcs.

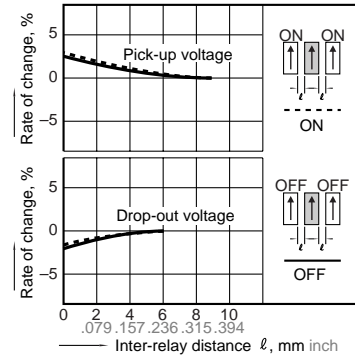

10-(2). Influence of adjacent mounting

Tested sample: TX2-12V, 6 pcs.

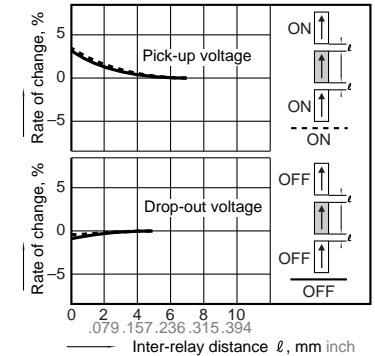

11. Pulse dialing test

Tested sample: TX2-5V, 6 pcs.
(35 mA 48 V DC wire spring relay load)

Circuit

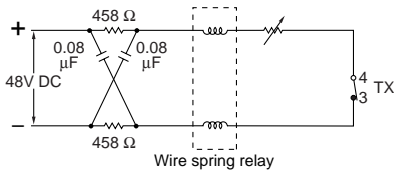

Change of pick-up and drop-out voltage

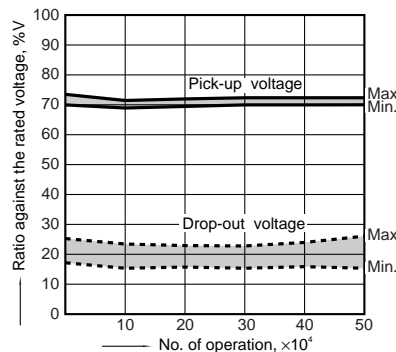

Change of contact resistance

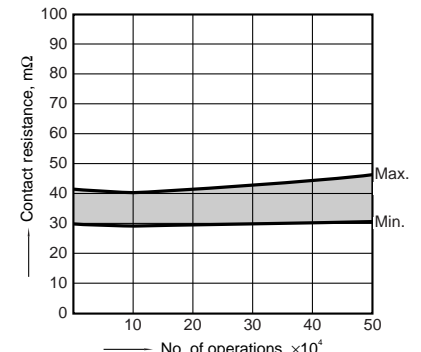

Note: Data of surface-mount type are the same as those of PC board terminal type.



DIMENSIONS (mm inch)

The CAD data of the products with a **CAD Data** mark can be downloaded from: <http://panasonic-electric-works.net/ac>

1. Standard PC board terminal and Self clinching terminal

CAD Data



Single side stable and 1 coil latching type
External dimensions
Standard PC board terminal

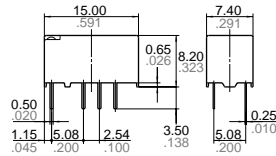

2 coil latching type (L2, LT)
External dimensions
Standard PC board terminal

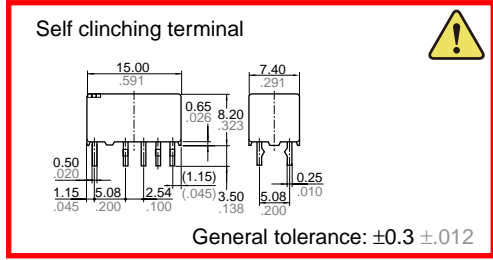
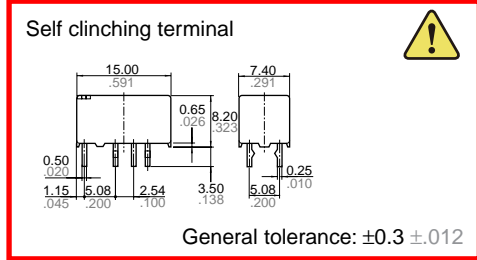
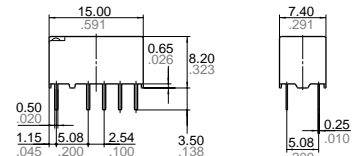

PC board pattern (Bottom view)

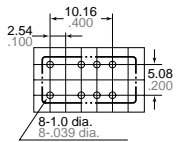

Schematic (Bottom view)
Single side stable

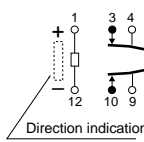

1 coil latching

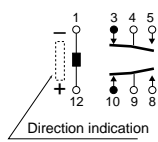

PC board pattern (Bottom view)

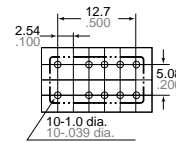

Schematic (Bottom view)
2 coil latching (L2)

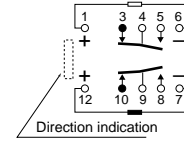

2 coil latching (LT)

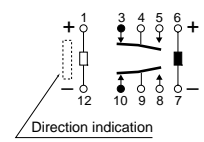

Tolerance: $\pm 0.1 \pm 0.04$

(Deenergized condition)

(Reset condition)

Tolerance: $\pm 0.1 \pm 0.04$

(Reset condition)

(Reset condition)

2. Surface-mount terminal

CAD Data



Type	External dimensions (General tolerance: $\pm 0.3 \pm 0.12$)		Suggested mounting pad (Top view) (Tolerance: $\pm 0.1 \pm 0.04$)	
	Single side stable and 1 coil latching type	2 coil latching type (L2, LT)	Single side stable and 1 coil latching type	2 coil latching type (L2, LT)
SA type				
SL type				
SS type				

Schematic (Top view)

Single side stable

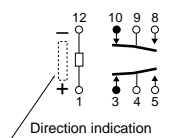

(Deenergized condition)

1 coil latching

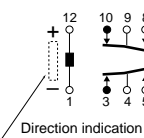

(Reset condition)

2 coil latching (L2)

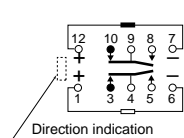

(Reset condition)

2 coil latching (LT)

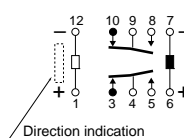

(Reset condition)

NOTES

1. Packing style

1) The relay is packed in a tube with the relay orientation mark on the left side, as shown in the figure below.

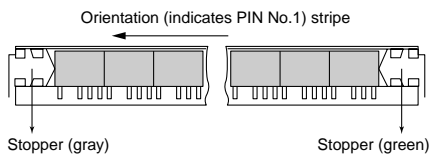

2) Tape and reel packing (surface-mount terminal type)

(1) Tape dimensions

(i) SA type

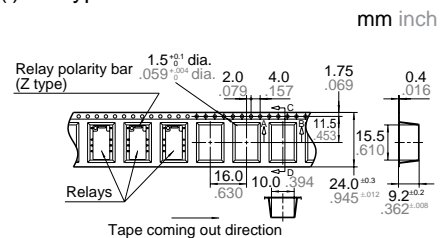

(ii) SL type

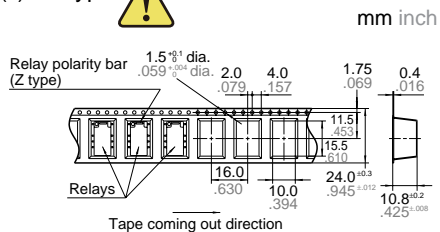

(iii) SS type

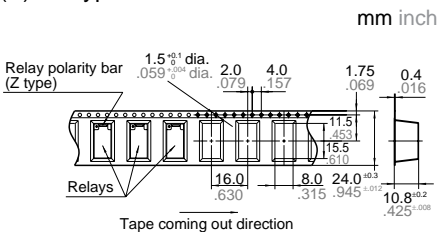

(2) Dimensions of plastic reel

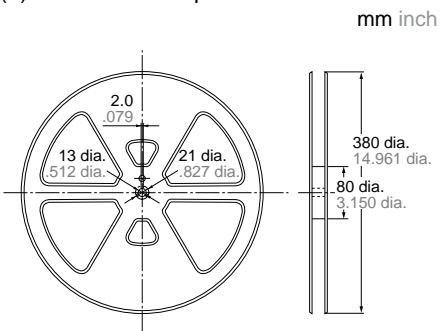

2. Automatic insertion

To maintain the internal function of the relay, the chucking pressure should not exceed the values below.

Chucking pressure in the direction A:
4.9 N {500gf} or less

Chucking pressure in the direction B:
9.8 N {1 kgf} or less

Chucking pressure in the direction C:
9.8 N {1 kgf} or less

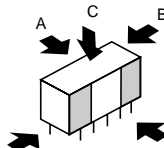

Please chuck the portion.

Avoid chucking the center of the relay. In addition, excessive chucking pressure to the pinpoint of the relay should be avoided.

For general cautions for use, please refer to the "Cautions for use of Signal Relays" or "General Application Guidelines".