

阅读申明

- 1.本站收集的数据手册和产品资料都来自互联网，版权归原作者所有。如读者和版权方有任何异议请及时告之，我们将妥善解决。
- 2.本站提供的中文数据手册是英文数据手册的中文翻译，其目的是协助用户阅读，该译文无法自动跟随原稿更新，同时也可能存在翻译上的不当。建议读者以英文原稿为参考以便获得更精准的信息。
- 3.本站提供的产品资料，来自厂商的技术支持或者使用者的心得体会等，其内容可能存在描述上的差异，建议读者做出适当判断。
- 4.如需与我们联系，请发邮件到marketing@iczoom.com，主题请标有“数据手册”字样。

Read Statement

1. The datasheets and other product information on the site are all from network reference or other public materials, and the copyright belongs to the original author and original published source. If readers and copyright owners have any objections, please contact us and we will deal with it in a timely manner.
2. The Chinese datasheets provided on the website is a Chinese translation of the English datasheets. Its purpose is for reader's learning exchange only and do not involve commercial purposes. The translation cannot be automatically updated with the original manuscript, and there may also be improper translations. Readers are advised to use the English manuscript as a reference for more accurate information.
3. All product information provided on the website refer to solutions from manufacturers' technical support or users the contents may have differences in description, and readers are advised to take the original article as the standard.
4. If you have any questions, please contact us at marketing@iczoom.com and mark the subject with "Datasheets" .

High capacity SSR
up to 40A
with wide variation

AQ-N RELAYS



FEATURES

1. Five types available from 10A to 40A
2. Built-in varistor
3. Includes operation LED (red)
4. Dielectric voltage of 4,000V
5. 4 to 32V DC input voltage
6. Both zero-cross and random types available

TYPICAL APPLICATIONS

1. Molding machine (heater control)
2. Temperature controlled bath (heater control)
3. Printing machines (heater control)
4. Wrapping and packing machine (heater control)
5. Machine tools (Motor control)

Compliance with RoHS Directive

ORDERING INFORMATION

A	Q	N				
AQ-N Solid State Relays						
Load current						
1: 10 A						
2: 15 A						
3: 20 A						
4: 25 A						
6: 40 A						
Load voltage						
1: 75 to 250 V AC, Zero-cross						
2: 75 to 250 V AC, Random						
Input voltage						
1: 4 to 32 V DC						
Function						
Nil: None						
V: Built-in varistor						
L: With LED indication						
VL: Built-in varistor and with LED indication						

TYPES

1. Standard type

Type	Load current	Load voltage	Part No.
Zero-cross type	10A	75 to 250V AC	AQN111
	15A		AQN211
	20A		AQN311
	25A		AQN411
	40A		AQN611
Random type	10A	75 to 250V AC	AQN121
	15A		AQN221
	20A		AQN321
	25A		AQN421
	40A		AQN621

2. With LED indication type

Type	Load current	Load voltage	Part No.
Zero-cross type	10A	75 to 250V AC	AQN111L
	15A		AQN211L
	20A		AQN311L
	25A		AQN411L
	40A		AQN611L
Random type	10A	75 to 250V AC	AQN121L
	15A		AQN221L
	20A		AQN321L
	25A		AQN421L
	40A		AQN621L

3. With varistor type

Type	Load current	Load voltage	Part No.
Zero-cross type	10A	75 to 250V AC	AQN111V
	15A		AQN211V
	20A		AQN311V
	25A		AQN411V
	40A		AQN611V
Random type	10A	75 to 250V AC	AQN121V
	15A		AQN221V
	20A		AQN321V
	25A		AQN421V
	40A		AQN621V

4. With varistor and LED indication type

Type	Load current	Load voltage	Part No.
Zero-cross type	10A	75 to 250V AC	AQN111VL
	15A		AQN211VL
	20A		AQN311VL
	25A		AQN411VL
	40A		AQN611VL
Random type	10A	75 to 250V AC	AQN121VL
	15A		AQN221VL
	20A		AQN321VL
	25A		AQN421VL
	40A		AQN621VL

Standard packing; carton: 2 pcs., case: 100 pcs.

5. Accessories

Type	Part No.	Packaged quantity
Standard heat sink (10A, 15A and 20A)	AQP-HS-J10A	5 in a carton, 20 in a case
Standard heat sink (25A)	AQP-HS-30/40A	5 in a carton, 20 in a case
Standard heat sink (40A)	AQP-HS-J25A	No carton, 5 in a case
Slim heat sink (45mm wide) (Mountable on a DIN rail)	AQP-HS-SJ20A	No carton, 8 in a case
DIN rail mounting plate	AQP-DP	10 in a carton, 100 in a case
Terminal cover	AQP-NPC	2 in a carton, 100 in a case

RATINGS

1. Ratings (Measurement condition: at 20°C 68°F, Input ripple: 1% or less)

1) Zero-cross type

Item	Type	10A	15A	20A	25A	40A	Remarks
	Part No.	AQN111 AQN111L AQN111V AQN111VL	AQN211 AQN211L AQN211V AQN211VL	AQN311 AQN311L AQN311V AQN311VL	AQN411 AQN411L AQN411V AQN411VL	AQN611 AQN611L AQN611V AQN611VL	
Input side	Input voltage	4 to 32V					*1
	Input current	Max. 20mA					*1
	Drop-out voltage	Min. 1V					
Output side	Max. load current	10A	15A	20A	25A	40A	*2
	Load voltage	75V to 250V					
	Frequency	45Hz to 65Hz					
	Non-repetitive surge current	100A	150A	200A	250A	400A	In one cycle at 60Hz *3
	Max. "OFF-state" leakage current	Max. 10mA					at 60Hz
	Max. "ON-state" voltage drop	1.6V					at Max. carrying current
	Min. load current	100mA					*4

Notes: *1. Please refer to REFERENCE DATA, "3. Input current vs. input voltage".

*2. Please refer to REFERENCE DATA, "1. Load current vs. ambient temperature".

*3. Please refer to REFERENCE DATA, "2. Non-repetitive surge current vs. carrying time".

*4. When the load current is less than the rated minimum load current, please refer to "Cautions for Use of SSR".

AQ-N

2) Random type

Item	Type	10A	15A	20A	25A	40A	Remarks
	Part No.	AQN121 AQN121L AQN121V AQN121VL	AQN221 AQN221L AQN221V AQN221VL	AQN321 AQN321L AQN321V AQN321VL	AQN421 AQN421L AQN421V AQN421VL	AQN621 AQN621L AQN621V AQN621VL	
Input side	Input voltage	4 to 32V					*1
	Input current	Max. 20mA					*1
	Drop-out voltage	Min. 1V					
Output side	Max. load current	10A	15A	20A	25A	40A	*2
	Load voltage	75V to 250V					
	Frequency	45Hz to 65Hz					
	Non-repetitive surge current	100A	150A	200A	250A	400A	In one cycle at 60Hz *3
	Max. "OFF-state" leakage current	Max. 10mA					at 60Hz
	Max. "ON-state" voltage drop	1.6V					at Max. carrying current
	Min. load current	100mA					*4

Notes: *1. Please refer to REFERENCE DATA, "3. Input current vs. input voltage".

*2. Please refer to REFERENCE DATA, "1. Load current vs. ambient temperature".

*3. Please refer to REFERENCE DATA, "2. Non-repetitive surge current vs. carrying time".

*4. When the load current is less than the rated minimum load current, please refer to "Cautions for Use of SSR".

2. Characteristics (Measurement condition: at 20°C 68°F, Input ripple: 1% or less)

1) Zero-cross type

Type	10A	15A	20A	25A	40A	Remarks
Part No.	AQN111 AQN111L AQN111V AQN111VL	AQN211 AQN211L AQN211V AQN211VL	AQN311 AQN311L AQN311V AQN311VL	AQN411 AQN411L AQN411V AQN411VL	AQN611 AQN611L AQN611V AQN611VL	
Operate time, max.	1/2 cycle of voltage sine wave + 1ms					
Release time, max.	1/2 cycle of voltage sine wave + 1ms					
Insulation resistance, min.	100MΩ between input and output					at 500 V DC
Breakdown voltage	4,000 Vrms between input and output; 2,500 Vrms between input, output and case					for 1min.
Vibration resistance (Functional)	10 to 55Hz double amplitude of 1.5mm					X, Y, Z axes
Shock resistance (Functional)	Min. 980 m/s ²					X, Y, Z axes
Ambient temperature	-20°C to +80°C -4°F to +176°F*2					Non-condensing at low temperatures
Storage temperature	-25°C to +85°C -13°F to +185°F					
Operational method	Zero-cross (Turn-ON and Turn-OFF)					

2) Random type

Type	10A	15A	20A	25A	40A	Remarks
Part No.	AQN121 AQN121L AQN121V AQN121VL	AQN221 AQN221L AQN221V AQN221VL	AQN321 AQN321L AQN321V AQN321VL	AQN421 AQN421L AQN421V AQN421VL	AQN621 AQN621L AQN621V AQN621VL	
Operate time, max.	1ms					
Release time, max.	1/2 cycle of voltage sine wave + 1ms					
Insulation resistance, min.	100MΩ between input and output					at 500 V DC
Breakdown voltage	4,000 Vrms between input and output; 2,500 Vrms between input, output and case					for 1min.
Vibration resistance (Functional)	10 to 55Hz double amplitude of 1.5mm					X, Y, Z axes
Shock resistance (Functional)	Min. 980 m/s ²					X, Y, Z axes
Ambient temperature	-20°C to +80°C -4°F to +176°F					Non-condensing at low temperatures
Storage temperature	-25°C to +85°C -13°F to +185°F					
Operational method	Random Turn-ON, Zero-cross Turn-OFF					

REFERENCE DATA

1. Load current vs. ambient temperature

Use load current within range specified in the figure below.

Tested condition

With external heat sink

- 1) (1) 10A, 15A, 20A type
Shown with standard heat sink (AQP801)
- (2) Shown with 25A type standard heat sink (AQP804)
- (3) Shown with 40A type standard heat sink (AQP806)
- (4) In the case of the AQP812 slim heat-sink types, characteristics data are available for each type. Please refer to (6).

- 2) If attached to a heat sink, use a heat conductive compound (Ex. Toshiba silicone YG6111 or TSK5303) of similar coating to improve cooling.

Without external heat sink

If the mounting surface is not metallic and a heat sink is not used, expose the bottom surface and plate surface to improve heat dissipation.

(1) 10A type

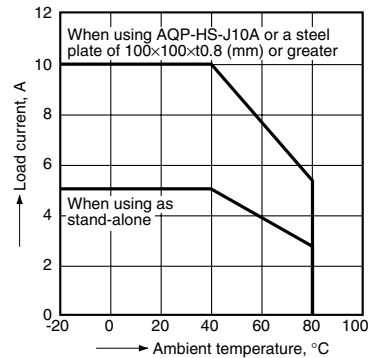

(2) 15A type

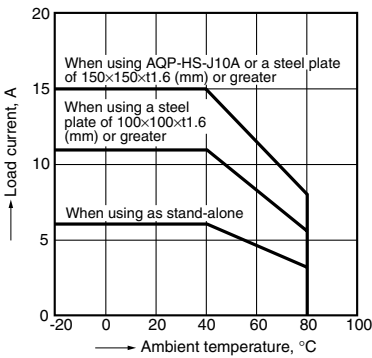

(3) 20A type

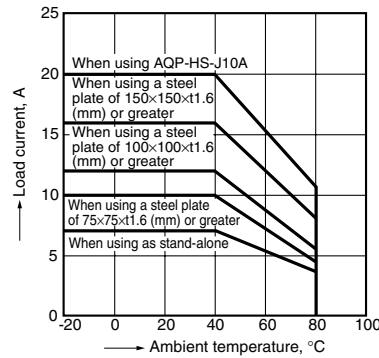

(4) 25A type

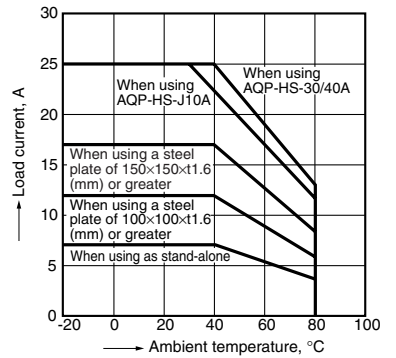

(5) 40A type

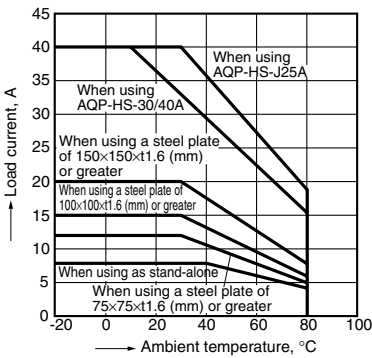

(6) Data when mounted on an AQP-HS-SJ20A slim heat sink

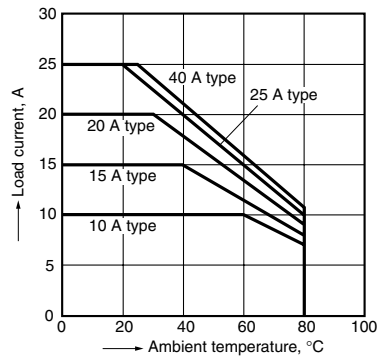

2. Non-repetitive surge current vs. carrying time

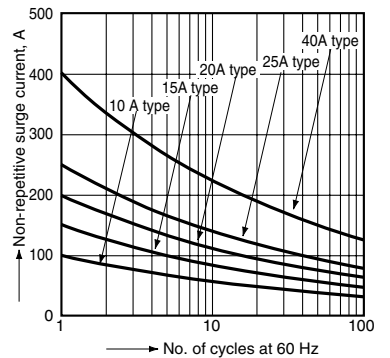

3. Input current vs. input voltage

10A, 15A, 20A, 25A, 40A common

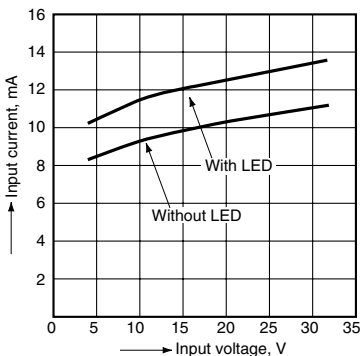

AQ-N

DIMENSIONS (mm inch)

The CAD data of the products with a **CAD Data** mark can be downloaded from: <http://panasonic-electric-works.net/ac>

* The right figure is the LED indication type. The standard type has the same dimensions.

CAD Data

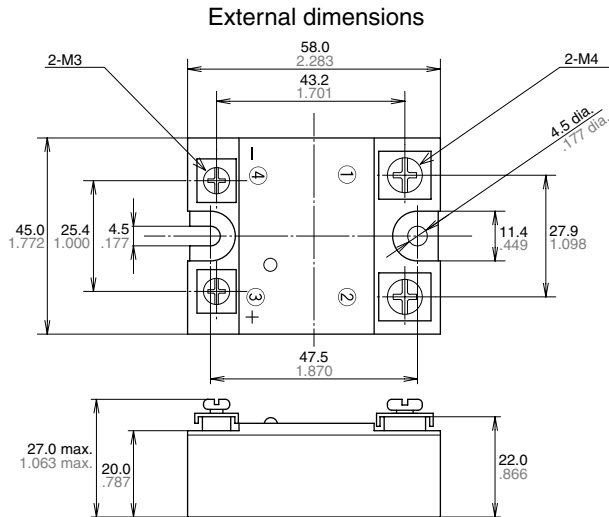

Schematic

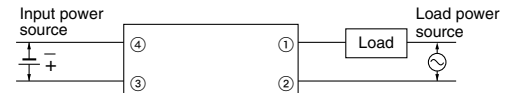

Mounting dimensions

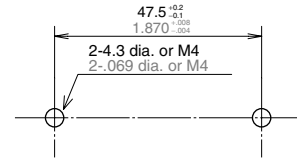

ACCESSORIES

AQP-HS-SJ20A Slim Heat Sink

CAD Data

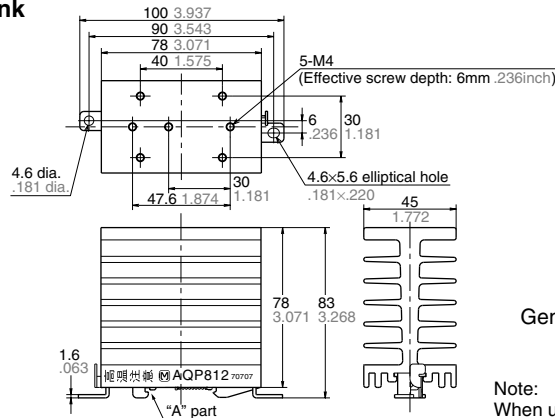
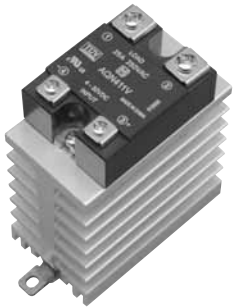

Mounting dimensions

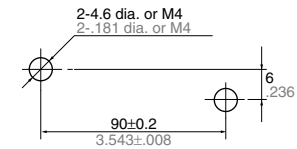

General tolerance: $\pm 1.0 \pm .039$

Note: When using on a DIN rail, please install so that the "A" part is on top.

AQP-HS-J10A Standard Heat Sink

CAD Data

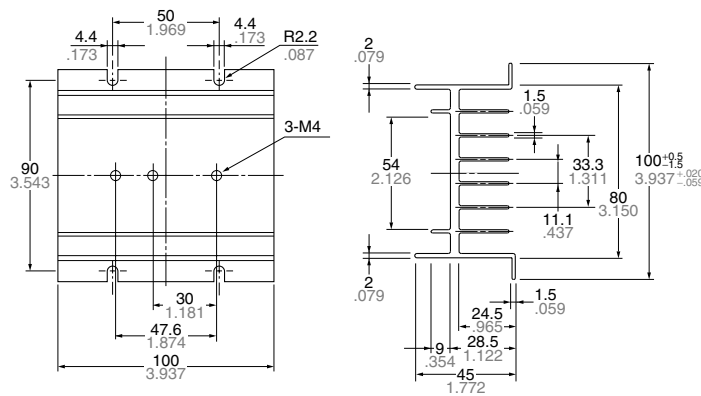

Mounting dimensions

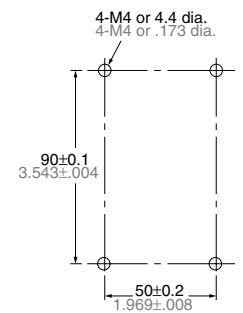

AQP-HS-30/40A Standard Heat Sink

CAD Data

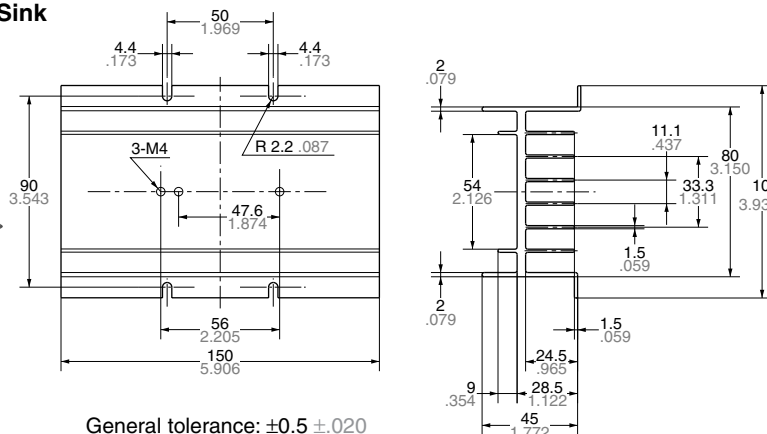

Mounting dimensions

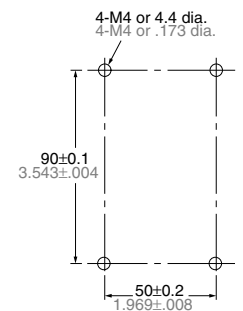

General tolerance: $\pm 0.5 \pm .020$

AQP-HS-J25A Standard Heat Sink

CAD Data

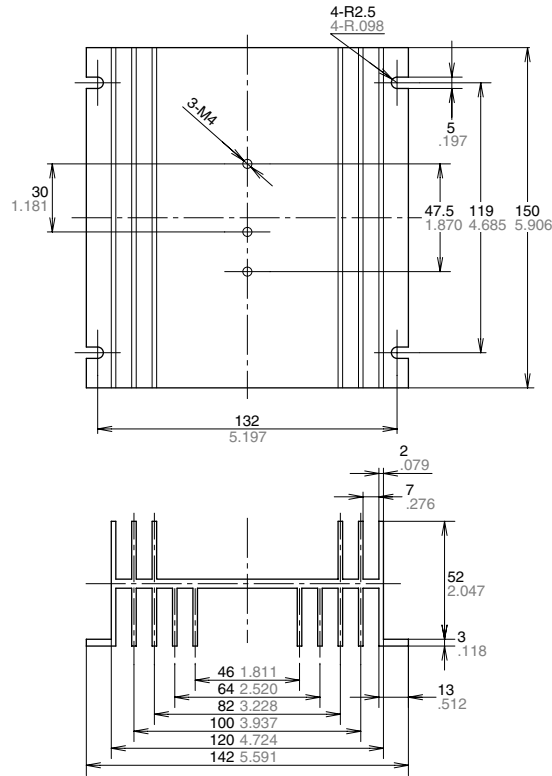

Mounting dimensions

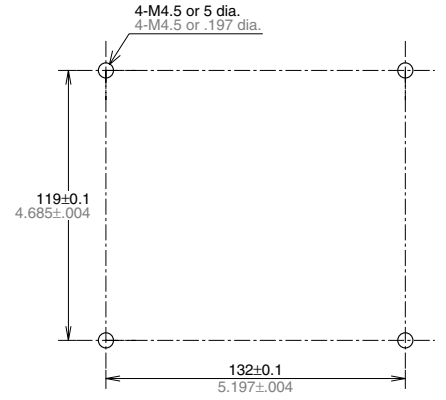

AQP-DP DIN Rail Mounting Plate

CAD Data

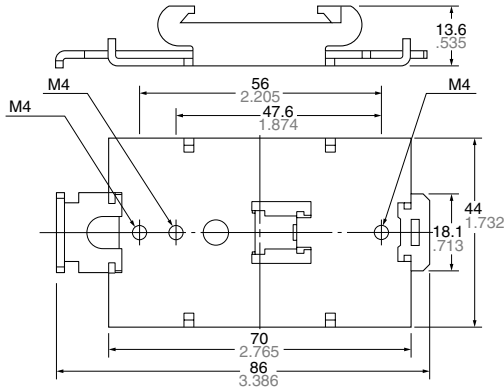

General tolerance: ±0.5 ±0.020

AT8-DLA1 Mounting Rail

CAD Data

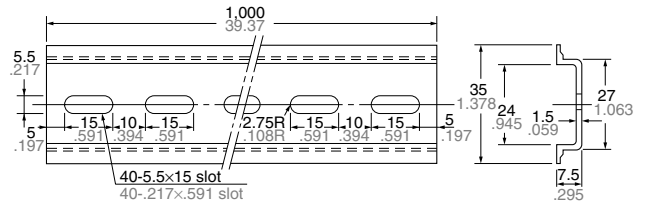

ATA4806 Fastening Plate

CAD Data

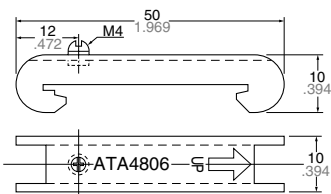

AQP-NPC Terminal Cover

CAD Data

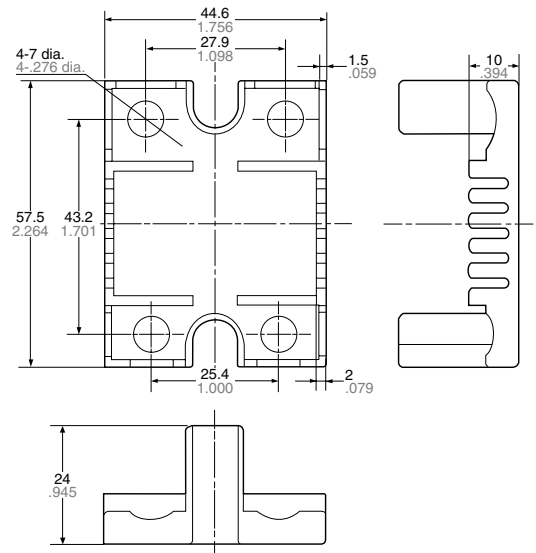
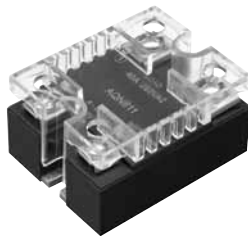

Recommended Temperature Controllers

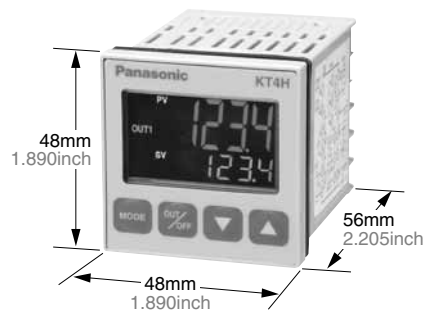

<KT4H Temperature Controller>

Our temperature controller is recommended for use with our Solid State Relays.

Features

- Data can be collected using the RS485 communications interface via a PLC.
- Improved visibility using a negative type LCD and backlight.
- Depth-wise length (chassis dimension) is 56 mm 2.205 inch.

Substitute part numbers

Power supply	Control output	Part No.
100 to 240 V AC	Relay contact	AKT4H111100

*For detailed product information about temperature controllers, please refer to our website:
http://panasonic-denko.co.jp/ac/e/fasys/component/temperature_controller/

For Cautions for Use