

## 阅读申明

- 1.本站收集的数据手册和产品资料都来自互联网，版权归原作者所有。如读者和版权方有任何异议请及时告之，我们将妥善解决。
- 2.本站提供的中文数据手册是英文数据手册的中文翻译，其目的是协助用户阅读，该译文无法自动跟随原稿更新，同时也可能存在翻译上的不当。建议读者以英文原稿为参考以便获得更精准的信息。
- 3.本站提供的产品资料，来自厂商的技术支持或者使用者的心得体会等，其内容可能存在描述上的差异，建议读者做出适当判断。
- 4.如需与我们联系，请发邮件到marketing@iczoom.com，主题请标有“数据手册”字样。

## Read Statement

1. The datasheets and other product information on the site are all from network reference or other public materials, and the copyright belongs to the original author and original published source. If readers and copyright owners have any objections, please contact us and we will deal with it in a timely manner.
2. The Chinese datasheets provided on the website is a Chinese translation of the English datasheets. Its purpose is for reader's learning exchange only and do not involve commercial purposes. The translation cannot be automatically updated with the original manuscript, and there may also be improper translations. Readers are advised to use the English manuscript as a reference for more accurate information.
3. All product information provided on the website refer to solutions from manufacturers' technical support or users the contents may have differences in description, and readers are advised to take the original article as the standard.
4. If you have any questions, please contact us at marketing@iczoom.com and mark the subject with "Datasheets" .

# Ultra Small Surface Mount Coaxial Connectors - 1.9mm or 2.4mm Mated Height

## U.FL Series



### Up to 6GHz Transmission Speed

#### Mated height comparison (with E.FL series)

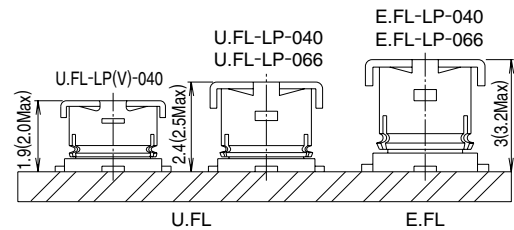

### ■ Features

- 1. Nominal mated height of 1.9 or 2.4mm (Max. 2.0 or 2.5mm)**
- 2. Small mounting area**  
The receptacle occupies an area of 7.7mm<sup>2</sup>.
- 3. Light weight**  
Receptacle: 15.7mg
- 4. Accepts high frequency transmission.**  
To meet the frequency requirements of a wide variety of miniature devices, the connectors offer high frequency performance from DC to 6GHz, with a V.S.W.R. of 1.3 to 1.5 max.
- 5. Automatic board placement**  
Packaged on tape-and-reel the receptacles can be placed with vacuum nozzles of the automatic placement equipment.
- 6. Plugs are terminated with ultra-fine coaxial (fluorinated resin insulated) cable**  
Standard ultra-fine coaxial cable of 0.81mm diameter (single braid shielding) is used for the plug termination, assuring secure and stable connections.
- 7. Simple connector mating / unmating**  
Use of available extraction tool assures correct disconnection of the plug and receptacle.
- 8. Verification of the fully mated condition**  
Tactile click sensation confirms fully mated condition, assuring complete electrical and mechanical connection.

### ■ Applications

Cellular phones, PHS, mobile phones, wireless communication devices, electronic measuring instruments, GPS, wireless LAN, Bluetooth and any application requiring high frequency transmission using small coaxial connectors.

### ● Space Factor of Mated Connector



## U.F.L Series Ultra Small Surface Mount Coaxial Connectors - 1.9mm or 2.4mm Mated Height

### Product Specifications

Ratings	Nominal characteristic impedance	50 ohms	Operating temperature range	-40°C to +90°C	Storage temperature range	-30°C to +70°C
	Frequency range	DC to 6GHz	Operating humidity	90%RH max.	Storage humidity	90%RH max.

Item	Specification	Conditions	
1. Contact resistance	Center : 20 m ohms max. Outer : 10 m ohms max.	10 mA max.	
2. Insulation resistance	500 M ohms min.	100 V DC	
3. Withstanding voltage	No flashover or insulation breakdown.	200 V AC / 1 minute	
4. V.S.W.R.*	Part No.	Up to 3GHz	3 to 6GHz
	U.FL-LP-040 dia.0.81mm Coaxial Cable Assembly	1.3 Max	1.35 Max
	U.FL-LP(V)-040 dia.0.81mm Coaxial Cable Assembly	1.3 Max	1.3 Max
	U.FL-LP-066 dia.1.13mm Coaxial Cable Assembly	1.3 Max	1.4 Max
	U.FL-LP-066 dia.1.32mm Coaxial Cable Assembly	1.3 Max	1.5 Max
	U.FL-LP-062 dia.1mm Coaxial Cable Assembly	1.3 Max	1.3 Max
	U.FL-LP-088 dia.1.37mm Coaxial Cable Assembly	1.3 Max	1.4 Max
5. Durability (mating / un-mating, with corresponding plug)	Contact resistance Center : 25 m ohms max. Outer : 15 m ohms max.	30 cycles	
6. Vibration	No electrical discontinuity of 1μs min.	Frequency: 10 to 100 Hz, single amplitude of 1.5mm, acceleration of 59m/s <sup>2</sup> , for 5 cycles in the direction of each of the 3 axis.	
7. Shock	No damage, cracks or parts dislocation.	Acceleration of 735 m/s <sup>2</sup> , 11ms duration, sine half-wave waveform, 3 cycles in each of 3 axes.	
8. Humidity (Steady state)	No damage, cracks or parts dislocation. Insulation resistance 10 M ohms min.(humidity high) Insulation resistance 500 M ohms min.(dry)	96 hours at temperature of 40°C and humidity of 95%.	
9. Temperature cycle	No damage, cracks or parts dislocation. Contact resistance: 25 m ohms max. (Center) 15 m ohms max. (Outer)	Temperature: -40°C→+5 to +35°C→+90°C→+5 to +35°C Time: 30min.→ 3min. →30min.→ 3min. 5 cycles	
10. Salt spray	No excessive corrosion	5% salt water solution, 48 hours	

\*V.S.W.R. Measurement System

The above V.S.W.R. standard values were measured using the measurement connection shown below.

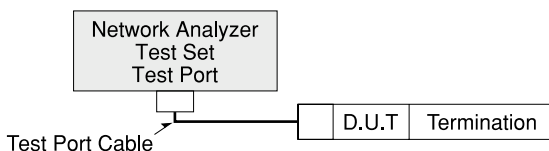

Note 1: Cable type connectors were measured with SMA conversion adapters attached to both ends of the harness product of a suitable 100cm cable.

Note 2: Board type connectors were mounted to a 50Ω glass epoxy board and measurements were conducted with SMA conversion adapters attached.

### Material / Finishes

Part	Material		Finish	Remarks
Shell	Phosphor bronze		Silver plated	_____
Male center contact	Brass		Gold plated	_____
Female center contact	Phosphor bronze		Gold plated	_____
Insulator	Plug	PBT	Color: Black	UL94V-0
	Receptacle	LCP	Color: Beige	UL94V-0

## Receptacles



- Note 1: Receptacles of (01) specification are sold by the bag with 100 pieces per bag. Please order in pack units.
- Note 2: Receptacles of (10) specification are sold by the reel (which contains 2,500 pieces). Please order in reel units.
- Note 3: Receptacles of (40) specification are sold by the reel (Which contains 4,000 pieces)
- Note 4: This area may be covered by insulating material.



## Recommended PCB Mounting Pattern



Part No.	CL No.	Packaging	Weight / EA	RoHS
U.F.L-R-SMT-1(01)	331-0472-2-01	Bag packaging (100 pieces/bag)	15.7/mg	YES
U.F.L-R-SMT-1(10)	331-0472-2-10	Reel packaging (2,500 pieces/reel)		
U.F.L-R-SMT-1(40)	331-0472-2-40	Reel packaging (4,000 pieces/reel)		

## Packaging Specifications

### Embossed Carrier Tape Dimensions

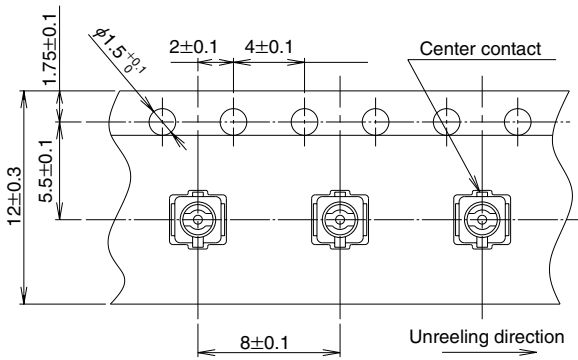

### Reel Dimensions

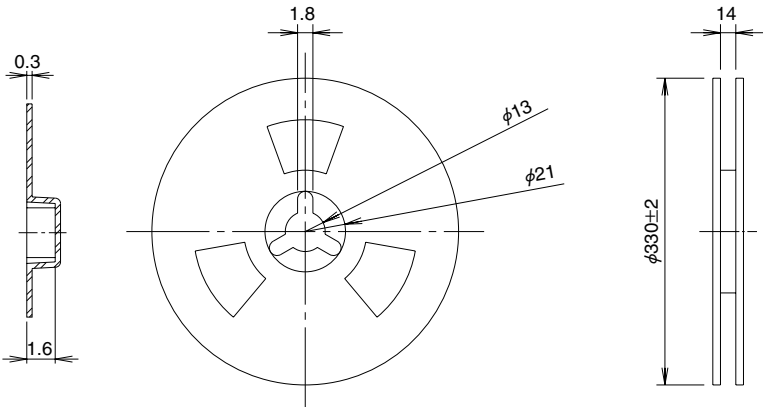

U.FL Series Ultra Small Surface Mount Coaxial Connectors - 1.9mm or 2.4mm Mated Height

## ■ Cable Assembly (Plug)

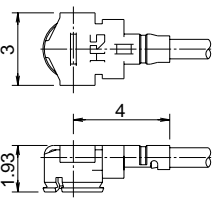
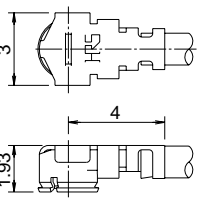
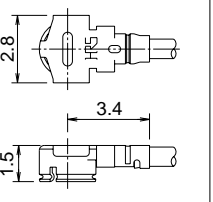
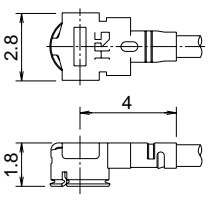
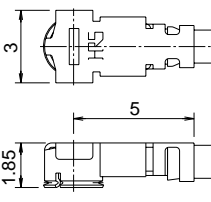

	U.FL-LP-040	U.FL-LP-066	U.FL-LP(V)-040	U.FL-LP-062	U.FL-LP-088
Part No.					
Mated Height	2.5mm Max. (2.4mm Nom.)	2.5mm Max. (2.4mm Nom.)	2.0mm Max. (1.9mm Nom.)	2.4mm Max. (2.3mm Nom.)	2.4mm Max. (2.3mm Nom.)
Applicable cable	Dia. 0.81mm Coaxial cable	Dia. 1.13mm and Dia. 1.32mm Coaxial cable	Dia. 0.81mm Coaxial cable	Dia. 1mm Coaxial cable	Dia. 1.37mm Coaxial cable
Weight (mg)	53.7	59.1	34.8	45.5	71.7
RoHS	YES				

## ● Cable Guide

Description	Cable Type	Cable Specification						
		Inner Conductor*	Dielectric Diameter	Outer Conductor*	Jacket Diameter	Nominal Impedance	Nominal attenuation	
							At 3GHz	At 6GHz
Dia.0.81mm Coaxial Cable	04	7/0.05 SA (AWG36)	Dia.0.40 PFA	Single Shield TA[SA]	Dia.0.81 PFA	50 ohms	6.52dB/m [6.45dB/m]	9.52dB/m [9.42dB/m]
Dia.1.13mm Coaxial Cable	068	7/0.08 SA (AWG32)	Dia.0.68 FEP	Single Shield TA[SA]	Dia.1.13 FEP	50 ohms	3.73dB/m [3.43dB/m]	5.44dB/m [5.13dB/m]
Dia.1.32mm Coaxial Cable	066	7/0.08 SA (AWG32)	Dia.0.66 FEP	Double Shield TA	Dia.1.32 FEP	50 ohms	3.8dB/m	5.6dB/m
Dia.1mm Coaxial Cable	062	7/0.071 SA (AWG33)	Dia.0.62 FEP	Tape, single Shield TAT	Dia.1 FEP	50 ohms	3.1dB/m	4.4dB/m
Dia.1.37mm Coaxial Cable	088	7/0.102 SA (AWG30)	Dia.0.88 FEP	Single Shield TA	Dia.1.37 FEP	50 ohms	2.8dB/m	4.3dB/m

(data as provided by cable suppliers, for reference only)

\* SA : Silver plated annealed copper wire, TA : Tin plated annealed copper wire, TAT : Tin plated copper wire alloyed with tin

## How to Specify Plug Cable Assembly

Double-Ended Cable Assembly



Single-Ended Cable Assembly

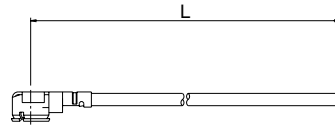

### Ordering Information

**U.FL - [1] LP - [2] - A - (L)**

①                      ②                      ③                      ④

① Series name	U.FL
② Assembly type	LP: Single ended 2LP: Double ended
③ Cable type	04 : Dia.0.81mm Coaxial Cable 068 : Dia.1.13mm Coaxial Cable 066 : Dia.1.32mm Coaxial Cable 062 : Dia.1 mm Coaxial Cable 088 : Dia.1.37mm Coaxial Cable
④ Total length(mm)	Length(L)

### Standard Tolerances for (L)

L	Standard Tolerance
L=35 to 200mm	± 4mm
L=200 to 500mm	± 8mm
L=500 to 1000mm	±12mm
L=Longer than 1000mm	±1.5% of (L)

Note1: Minimum available length (L) is 35mm

Note2: Contact nearest HRS representative if different tolerances are required.

Note3: Contact Nearest HRS representative if one end requires preparation.

Part No. of Plug	Part No. of Cable Assembly	Description	RoHS
U.FL-LP-040	U.FL-2LP-04N1T-A-(L)	Dia. 0.81mm double ended coaxial cable, color: white	YES
	U.FL-2LP-04N2T-A-(L)	Dia. 0.81mm double ended coaxial cable, color: black	
	U.FL-LP-04N1T-A-(L)	Dia. 0.81mm single ended coaxial cable, color: white	
	U.FL-LP-04N2T-A-(L)	Dia. 0.81mm single ended coaxial cable, color: black	
U.FL-LP-066	U.FL-2LP-068N1T-A-(L)	Dia. 1.13mm double ended coaxial cable, color: gray	
	U.FL-2LP-068N2T-A-(L)	Dia. 1.13mm double ended coaxial cable, color: black	
	U.FL-LP-068N1T-A-(L)	Dia. 1.13mm single ended coaxial cable, color: gray	
	U.FL-LP-068N2T-A-(L)	Dia. 1.13mm single ended coaxial cable, color: black	
U.FL-LP-066	U.FL-2LP-066N1-A-(L)	Dia. 1.32mm double ended coaxial cable, color: gray	
	U.FL-2LP-066N2-A-(L)	Dia. 1.32mm double ended coaxial cable, color: black	
	U.FL-LP-066N1-A-(L)	Dia. 1.32mm single ended coaxial cable, color: gray	
	U.FL-LP-066N2-A-(L)	Dia. 1.32mm single ended coaxial cable, color: black	
U.FL-LP(V)-040	U.FL-2LP(V)-04N1T-A-(L)	Dia. 0.81mm double ended coaxial cable, color: white	
	U.FL-2LP(V)-04N2T-A-(L)	Dia. 0.81mm double ended coaxial cable, color: black	
	U.FL-LP(V)-04N1T-A-(L)	Dia. 0.81mm single ended coaxial cable, color: white	
	U.FL-LP(V)-04N2T-A-(L)	Dia. 0.81mm single ended coaxial cable, color: black	
U.FL-LP-062	U.FL-2LP-062N1D-A-(L)	Dia. 1mm double ended coaxial cable, color: gray	
	U.FL-2LP-062N2D-A-(L)	Dia. 1mm double ended coaxial cable, color: black	
	U.FL-LP-062N1D-A-(L)	Dia. 1mm single ended coaxial cable, color: gray	
	U.FL-LP-062N2D-A-(L)	Dia. 1mm single ended coaxial cable, color: black	
U.FL-LP-088	U.FL-2LP-088N1T-A-(L)	Dia. 1.37mm double ended coaxial cable, color: gray	
	U.FL-2LP-088N2T-A-(L)	Dia. 1.37mm double ended coaxial cable, color: black	
	U.FL-LP-088N1T-A-(L)	Dia. 1.37mm single ended coaxial cable, color: gray	
	U.FL-LP-088N2T-A-(L)	Dia. 1.37mm single ended coaxial cable, color: black	

Please contact Hirose Sales Representative for cable length and cable end treatment.

**U.FL Series Ultra Small Surface Mount Coaxial Connectors - 1.9mm or 2.4mm Mated Height**

**■ Conversion Adapters**

**● SMA Conversion Adapter  
 (Mating portion: U.FL side jack - SMA side plug)**



Note: The U.FL side mating portions has a lower lock retention force than the regular product, therefore, cannot be used for purposes other than performance measurements.

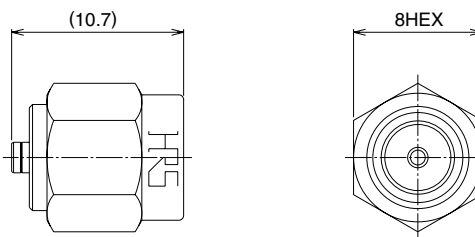

Part No.	CL No.	RoHS
HRMP-U.FLJ(40)	311-0300-2-40	YES

**● SMA Conversion Adapter  
 (Mating portion: U.FL side plug - SMA side jack)**



Note: The U.FL side mating portions has a lower lock retention force than the regular product, therefore, cannot be used for purposes other than performance measurements.

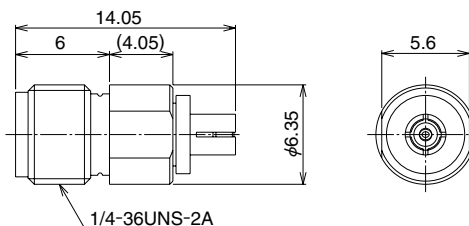

Part No.	CL No.	RoHS
HRMJ-U.FLP(40)	311-0301-5-40	YES

**● SMA Conversion Adapter  
 (Mating portion: U.FL side plug - SMA side jack)**



Note: This connector is used by compressing the mated portion of U.FL side onto the U.FL-R-SMT-1 portion.

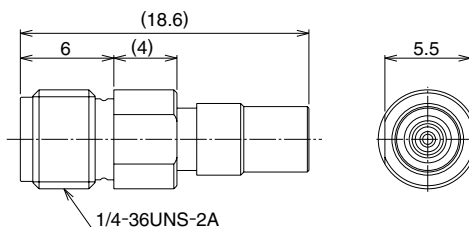

Part No.	CL No.	RoHS
HRMJ-U.FLP-ST1(40)	311-0385-5-40	YES

**■ Receptacle to Inspection**



This receptacle is used for inspecting the continuity, withstand voltage, and other aspects of the harness product.

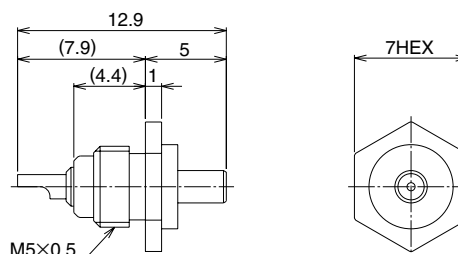

Part No.	CL No.	RoHS
U.FL-R-1	331-0466-0	YES

**■ Plug Extraction Tool**

This jig is used for extraction from a mating condition.



Note: Part No. U.FL-LP-N-2 for U.FL-LP-040/066/088.  
 Part No. U.FL-LP(V)-N-2 for U.FL-LP(V)-040/U.FL-LP-062.

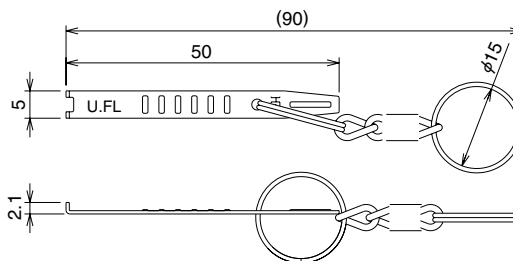

Part No.	CL No.	RoHS
U.FL-LP-N-2	331-0494-5	YES
U.FL-LP(V)-N-2	331-0493-2	

## Usage Precautions

### 1. Plugs

<p>(1) Mating / unmating</p>	<p>1) To disconnect connectors, insert the end portion of U.FL-LP-N-2 and U.FL-LP(V)-N-2 under the connector flanges and pull off vertically, in the direction of the connector mating axis.                  2) To mate the connectors, the mating axes of both connectors must be aligned and the connectors can be mated. The "click" will confirm fully mated connection. Do not attempt to insert on an extreme angle.</p> 
<p>(2) Pull forces on the cable after connectors are mated.</p>	<p>After the connectors are mating, do not apply a load to the cable in excess of the values indicated in the diagram below.</p>  <p>1N max (U.FL-LP(V)-040, U.FL-LP-062)                  2N max (U.FL-LP-040, U.FL-LP-066, U.FL-LP-088)</p> <p>3N max (U.FL-LP(V)-040, U.FL-LP-062)                  4N max (U.FL-LP-040, U.FL-LP-066, U.FL-LP-088)</p> <p>1N max (U.FL-LP(V)-040, U.FL-LP-062)                  2N max (U.FL-LP-040, U.FL-LP-066, U.FL-LP-088)</p>
<p>(3) Precautions</p>	<p>Do NOT forcefully twist or deform wires.</p>

### 2. Receptacles

<p>(1) Recommended reflow temperature profile</p>	 <p>① The temperature of the printed circuit board surface temperature at the points of contact with the terminals.                  ② Reflow soldering should be performed at a printed circuit surface temperature of 250°C max.                  ③ In individual applications the actual temperature may vary, depending on the solder paste type, volume / thickness and board size / thickness. Consult your solder paste and equipment manufacturer for specific recommendations.</p>
<p>(2) Recommended manual soldering</p>	<p>Manual soldering: 350°C for 5 seconds</p>
<p>(3) Recommended metal mask thickness</p>	<p>0.1 to 0.12 mm</p>
<p>(4) Reflow cycles</p>	<p>2 times</p>

### 3. Operating environment and storage conditions

<p>(1) Operating environment</p>	<p>The connectors are not designed to operate in the following environments:</p> <ul style="list-style-type: none"> <li>• Exposed to a excessive amounts of fine particles and dust</li> <li>• Regions and places having a high density of sulfur dioxide, hydrogen sulfide, nitrogen dioxide or other corrosive gasses.</li> <li>• Environments having large rapid variations in temperature.</li> </ul>
<p>(2) Storage conditions - Receptacle</p>	<p>Store in the Hirose Electric packaging.                  Temperature: -10 to +40°C, Humidity: 85% max.                  Use within 6 months of delivery.                  Receptacles for which the storage period has elapsed must be tested for solderability to the PC board mounting surface.</p>