

阅读申明

- 1.本站收集的数据手册和产品资料都来自互联网，版权归原作者所有。如读者和版权方有任何异议请及时告之，我们将妥善解决。
- 2.本站提供的中文数据手册是英文数据手册的中文翻译，其目的是协助用户阅读，该译文无法自动跟随原稿更新，同时也可能存在翻译上的不当。建议读者以英文原稿为参考以便获得更精准的信息。
- 3.本站提供的产品资料，来自厂商的技术支持或者使用者的心得体会等，其内容可能存在描述上的差异，建议读者做出适当判断。
- 4.如需与我们联系，请发邮件到marketing@iczoom.com，主题请标有“数据手册”字样。

Read Statement

1. The datasheets and other product information on the site are all from network reference or other public materials, and the copyright belongs to the original author and original published source. If readers and copyright owners have any objections, please contact us and we will deal with it in a timely manner.
2. The Chinese datasheets provided on the website is a Chinese translation of the English datasheets. Its purpose is for reader's learning exchange only and do not involve commercial purposes. The translation cannot be automatically updated with the original manuscript, and there may also be improper translations. Readers are advised to use the English manuscript as a reference for more accurate information.
3. All product information provided on the website refer to solutions from manufacturers' technical support or users the contents may have differences in description, and readers are advised to take the original article as the standard.
4. If you have any questions, please contact us at marketing@iczoom.com and mark the subject with "Datasheets" .

1

2

3

4

5

6

7

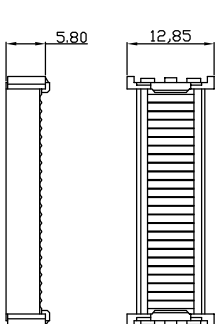
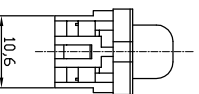
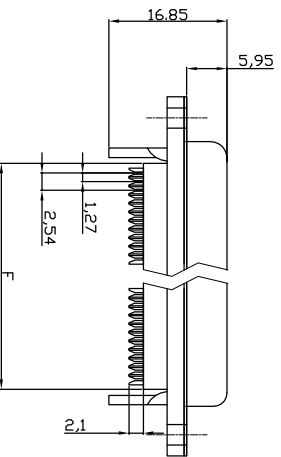
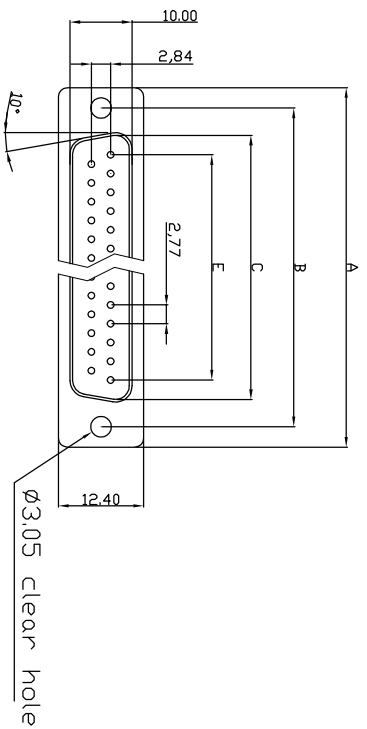
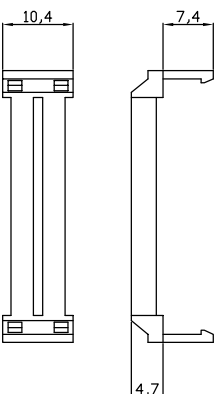
Male**Cover****Strain Relief**

| Positions | A | B | C | E | F |
|-----------|-------|-------|-------|-------|-------|
| 9 | 30.50 | 25.00 | 18.05 | 11.08 | 13.10 |
| 15 | 39.00 | 33.32 | 26.35 | 19.39 | 20.70 |
| 25 | 53.08 | 47.04 | 40.95 | 33.24 | 33.68 |
| 37 | 69.25 | 63.50 | 55.60 | 49.86 | 50.30 |

A-DXF xx LP111/FP
 Contact style: — FP - Full-plastic style
 S - Male
 No. of Contacts 09 / 15 / 25 / 37
 Standard Quality class ■

Product Specification**Material**

Insulator : Glass-Filled Thermoplastic PBT, UL94V-0
 Contact : Copper alloy

Electrical

Contact Resistance : 20 milliohms Max at 1 AMP DC.
 Insulation Resistance : 1000 megohms at 500 VDC
 Dielectric Withstanding Voltage : 1000 VAC/rms 60Hz for 1 minute
 Current Rating : 3 AMP
 Voltage Rating : 250 VAC/rms 60Hz
 Wire Spec : 26 AWG~28 AWG
 Operating Temperature: -55°C ~ +105°C
 Order Code:

RoHS compliant
 Unit: mm



File No.: E198287

1

2

3

4

5

6

7

| Scale | Free TOLERANCE | | | | | | | | | |
|-------|----------------|-----|-------------------------------|------------|--------|----------|------------|--------|-------------------|-------------|
| X. | ±0.38 | ③ | Update the dimension | 09.07.2014 | Winnie | Drawn | 15.08.2012 | Lucas | Customer-No. | |
| X.X | ±0.25 | ② | Update the wire specification | 28.06.2013 | Winnie | Approved | 09.07.2013 | Winnie | ASSMANN WSW-No. | |
| X.XX | ±0.13 | ① | Add the wire specification | 06.03.2013 | Winnie | | | | A-DXF xx LP111/FP | |
| DIM | TOL | ① | | | | | | | Drawing-No. | ASS 4890 CO |
| X.° | ±3° | | | | | | | | Replace | rev03 |
| X.X° | ±1.0° | ① | Drawn | 15.08.2012 | Lucas | | | | Sheet | 1/2 |
| Angle | TOL | Id. | Modification | Date | Name | | | | | |

ASSMANN
 WSW/ components

33.68

E

D

C

B

A

F

G

H

1

2

3

4

5

6

7

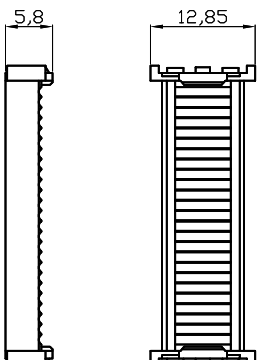
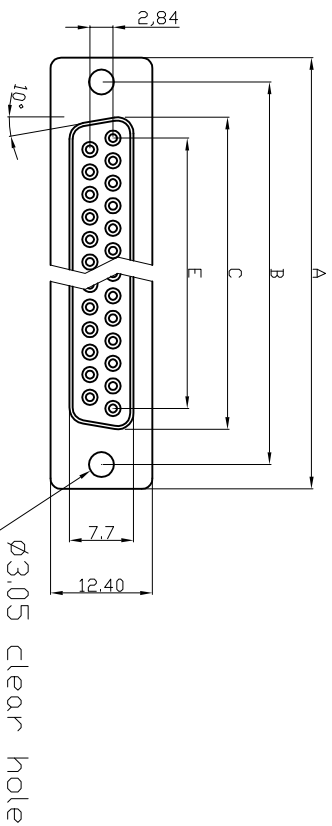
Female**Cover****Electrical**

Contact Resistance : 20 milliohms Max at 1 AMP DC.
 Insulation Resistance : 1000 megohms at 500 VDC.
 Dielectric Withstanding Voltage : 1000 VAC/rms 60Hz for 1 minute
 Current Rating : 3 AMP
 Voltage Rating : 250 VAC/rms 60Hz
 Wire Spec : 26 AWG-28 AWG
 Operating Temperature:-55°C+105°C

**Strain Relief**

| Dimensions Positions | A | B | D | E | F |
|----------------------|-------|-------|-------|-------|-------|
| 9 | 30.81 | 24.99 | 16.33 | 11.08 | 10.16 |
| 15 | 39.20 | 33.30 | 24.70 | 19.39 | 17.78 |
| 25 | 53.05 | 47.04 | 38.40 | 33.24 | 30.48 |
| 37 | 69.40 | 63.50 | 54.80 | 49.86 | 45.72 |

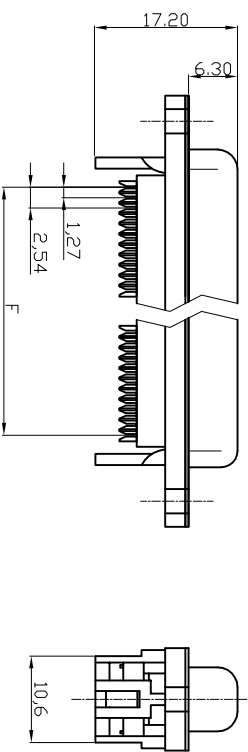
**With Insulator Support****RoHS compliant**

Unit: mm



File No.: E198287

| Scale | Free TOLERANCE |
|-------|----------------|
| X. | ±0.38 |
| X.X | ±0.25 |
| X.XX | ±0.13 |
| DIM | TOL |
| X.° | ±3° |
| X.X° | ±1.0° |
| Angle | TOL |

| Free TOLERANCE | Id. | Modification | Date | Name |
|----------------|-----|-------------------------------|------------|--------|
| ±0.38 | ③ | Update the dimension | 09.07.2014 | Winnie |
| ±0.25 | ② | Update the wire specification | 28.06.2013 | Winnie |
| ±0.13 | ① | Add the wire specification | 06.03.2013 | Winnie |
| TOL | ① | Drawn | 15.08.2012 | Lucas |

| Date | Name |
|------------|--------|
| 15.08.2012 | Lucas |
| 28.06.2013 | Winnie |

ASSMANN
 WSW/ components

| Customer-No. | Drawing-No. | Replace |
|--------------|---|-------------|
| | ASSMANN WSW-No. A-DXF XX LP111/FP | ASS 4890 CO |
| | | rev03 |
| | | Sheet 2/2 |

1

2

3

4

5

6

7

H

G

E

D

C

B

A