

## 阅读申明

- 1.本站收集的数据手册和产品资料都来自互联网，版权归原作者所有。如读者和版权方有任何异议请及时告之，我们将妥善解决。
- 2.本站提供的中文数据手册是英文数据手册的中文翻译，其目的是协助用户阅读，该译文无法自动跟随原稿更新，同时也可能存在翻译上的不当。建议读者以英文原稿为参考以便获得更精准的信息。
- 3.本站提供的产品资料，来自厂商的技术支持或者使用者的心得体会等，其内容可能存在描述上的差异，建议读者做出适当判断。
- 4.如需与我们联系，请发邮件到marketing@iczoom.com，主题请标有“数据手册”字样。

## Read Statement

1. The datasheets and other product information on the site are all from network reference or other public materials, and the copyright belongs to the original author and original published source. If readers and copyright owners have any objections, please contact us and we will deal with it in a timely manner.
2. The Chinese datasheets provided on the website is a Chinese translation of the English datasheets. Its purpose is for reader's learning exchange only and do not involve commercial purposes. The translation cannot be automatically updated with the original manuscript, and there may also be improper translations. Readers are advised to use the English manuscript as a reference for more accurate information.
3. All product information provided on the website refer to solutions from manufacturers' technical support or users the contents may have differences in description, and readers are advised to take the original article as the standard.
4. If you have any questions, please contact us at marketing@iczoom.com and mark the subject with "Datasheets" .

## PAN-WAY® METAL RACEWAY

Pan-Way® Metal Raceway is a series of single and multi-channel solutions for routing, protecting, concealing and terminating power wire and high performance copper, voice, video or fiber optic cable. Panduit metal raceway is designed with labor saving features to increase productivity and lower installed costs, while incorporating benefits of increased safety and cable protection. Pan-Way® Metal Raceway is an innovative routing solution that offers superior benefits over competitive systems:

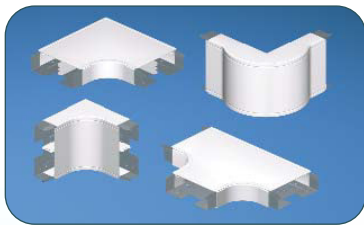

Pan-Way® Metal Raceway systems include a complete assortment of fittings, junction boxes, faceplates and accessories. They are available in white and almond color to match any decor and most popular electrical outlets. Systems are optimized for use with Panduit® Mini-Com® Modules for complete connectivity possibilities.

### PMR5 and PMR7 Single Channel Metal Raceway

- Raceway system features a patent pending bonding design that provides full continuity of the ground path between fittings and channel, for increased electrical safety
- System components incorporate an innovative snap-mount assembly method for fast installations, resulting in measurable contractor labor savings
- Fittings and mounts can be attached using various types and sizes of fasteners, eliminating the requirements of using only flat head style screws
- One-piece channel construction eliminates the problem of channel separation, associated with competitive two-piece designs, saving installation time

### PMR40 Multi-Channel Metal Raceway

- Raceway accepts standard double gang faceplates for increased termination options and reduced number of components
- System includes optional faceplates and fittings to support high performance Category 6A copper and fiber optic cabling terminations
- Full capacity 2 inch bend radius fittings provide necessary cable protection without restricting channel capacity

A.  
System  
Overview

B1.  
Cable Ties

B2.  
Cable  
Accessories

B3.  
Stainless  
Steel Ties

C1.  
Wiring  
Duct

C2.  
Surface  
Raceway

C3.  
Abrasion  
Protection

C4.  
Cable  
Management

D1.  
Terminals

D2.  
Power  
Connectors

D3.  
Grounding  
Connectors

E1.  
Labeling  
Systems

E2.  
Labels

E3.  
Pre-Printed  
& Write-On  
Markers

E4.  
Permanent  
Identification

E5.  
Lockout/  
Tagout  
& Safety  
Solutions

F.  
Index

A.  
System  
Overview

## PMR40 Raceway Roadmap

B1.  
Cable Ties

B2.  
Cable  
Accessories

B3.  
Stainless  
Steel Ties

C1.  
Wiring  
Duct

C2.  
Surface  
Raceway

C3.  
Abrasion  
Protection

C4.  
Cable  
Management

D1.  
Terminals

D2.  
Power  
Connectors

D3.  
Grounding  
Connectors

E1.  
Labeling  
Systems

E2.  
Labels

E3.  
Pre-Printed  
& Write-On  
Markers

E4.  
Permanent  
Identification

E5.  
Lockout/  
Tagout  
& Safety  
Solutions

F.  
Index

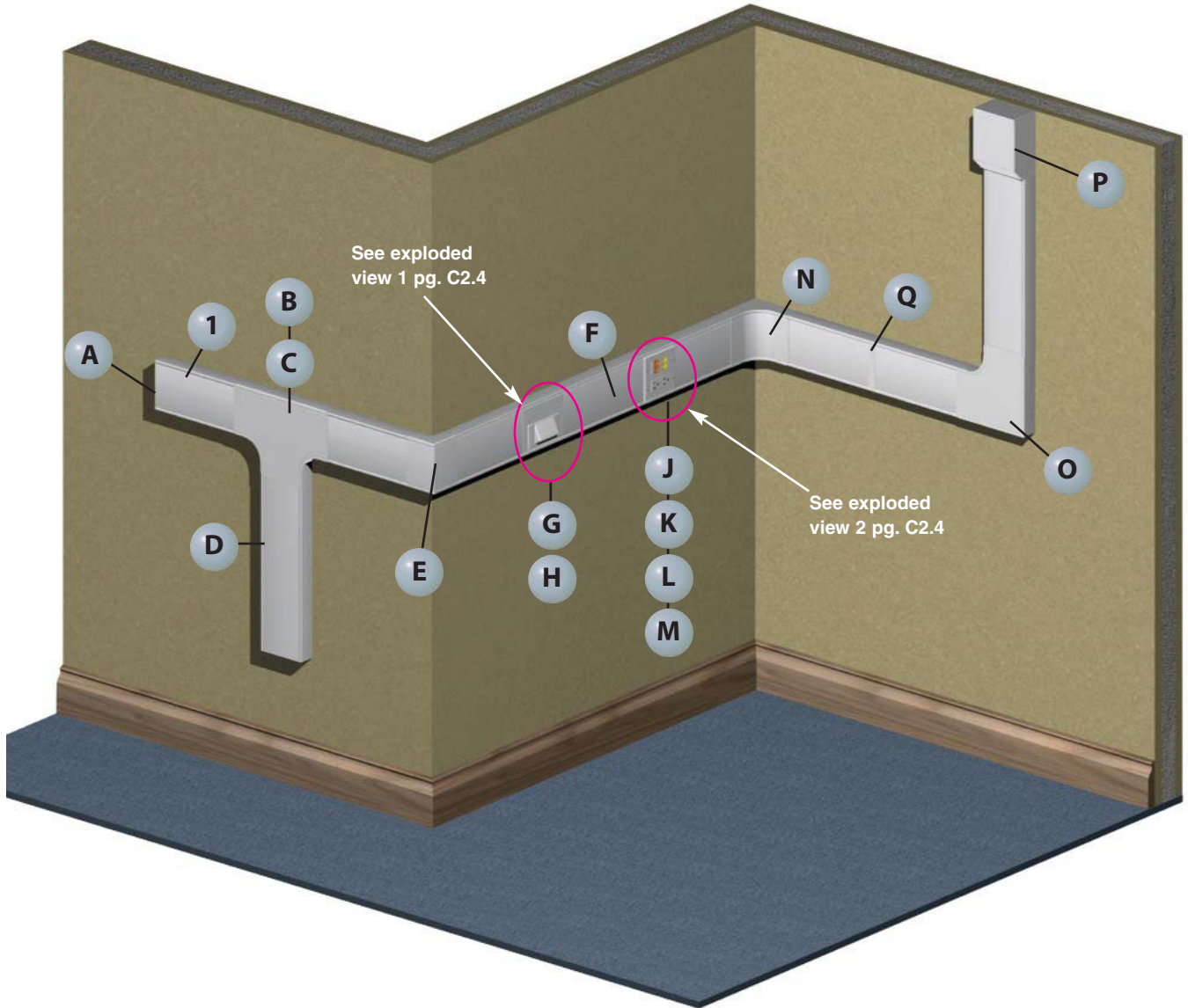



**1** PMR40\*\* – PMR40 Metal Raceway (page C2.5)

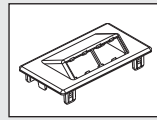

**G** PMR40FH4\*\* – Horizontal Sloped Communication Faceplate (page C2.6)

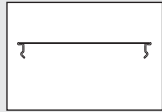

**1** PMR40C\*\* – PMR40 Cover (page C2.5)

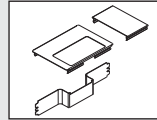

**H** PMR40DP50\*\* – PMR40 50/50 Data Plate (page C2.6)

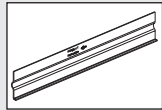

**1** PMR40DW\* – PMR40 Divider Wall (page C2.5)

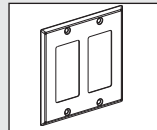

**J** MP2GR\*\* – Double Gang Rectangular Faceplate (page C2.17)

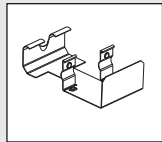

**1** PMR40DC-X – PMR40 Divider Clip (page C2.5)

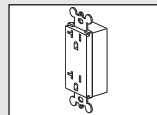

**K** ERU20\*\* – 20 A Specification Grade Rectangular Outlet (page C2.61)

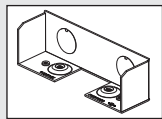

**A** PMR40EC\*\* – End Cap (page C2.6)

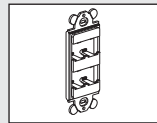

**L** CFG4 – Mini-Com® Frame (see SA-NCCB51)

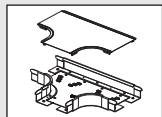

**B** PMR40T\*\* – Tee Fitting (page C2.6)

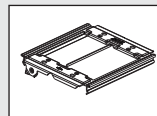

**M** PMR40DB50 – Device Bracket (page C2.6)

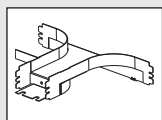

**C** PMR40TD50 – Tee Divider Insert (page C2.6)

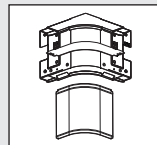

**N** PMR40IC\*\* – Inside Corner (page C2.6)

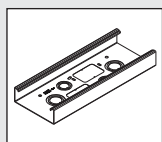

**D** PMR40BF\*\* – Backfeed Fitting (page C2.6)

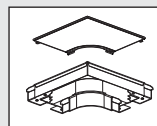

**O** PMR40RA\*\* – Right Angle (page C2.5)

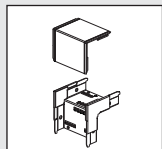

**E** PMR40SOC\*\* – Outside Corner (no bend radius) (page C2.6)

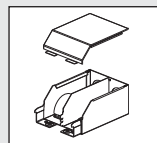

**P** PMR40EE\*\* – Entrance End (page C2.6)

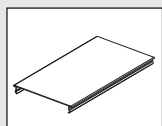

**F** PMR40C\*\*7.5 – Pre-Cut Cover for mounting devices on 12" centers (page C2.5)

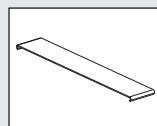

**Q** PMR40SC\*\*-X – Seam Clip (page C2.5)

A. System Overview

B1. Cable Ties

B2. Cable Accessories

B3. Stainless Steel Ties

C1. Wiring Duct

C2. Surface Raceway

C3. Abrasion Protection

C4. Cable Management

D1. Terminals

D2. Power Connectors

D3. Grounding Connectors

E1. Labeling Systems

E2. Labels

E3. Pre-Printed & Write-On Markers

E4. Permanent Identification

E5. Lockout/Tagout & Safety Solutions

F. Index

A.  
System  
Overview

## PMR40 Configurations

B1.  
Cable Ties

### Exploded View 1

	Components Required	See page
A.	PMR40FH4 = Horizontal sloped communication faceplate.	C2.6
B.	PMR40DP50** = PMR40 50/50 data plate and offset divider wall.	C2.6
C.	Mini-Com® Modules.	—

B2.  
Cable  
Accessories

B3.  
Stainless  
Steel Ties

C1.  
Wiring  
Duct

C2.  
Surface  
Raceway

C3.  
Abrasion  
Protection

C4.  
Cable  
Management

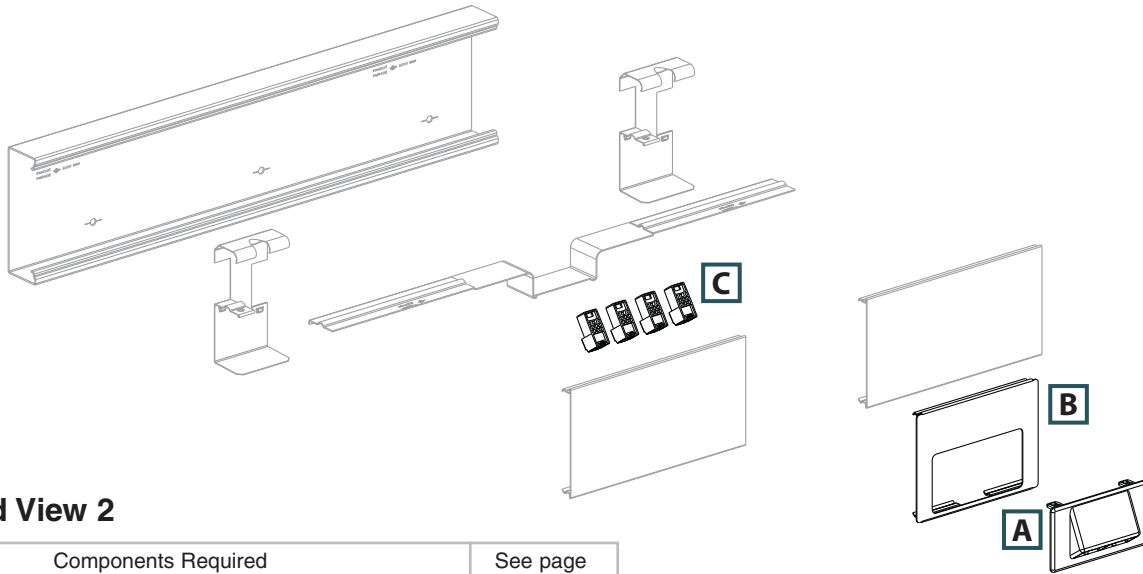

D1.  
Terminals

### Exploded View 2

	Components Required	See page
A.	MP2GR** = Double gang rectangular faceplate.	C2.17
B.	ERU20** = 20 V specification grade rectangular outlet.	C2.61
C.	CFG4 = Mini-Com® Frame.	—
D.	Mini-Com® Modules.	—
E.	PMR40DB50 = Device bracket.	C2.6

D2.  
Power  
Connectors

D3.  
Grounding  
Connectors

E1.  
Labeling  
Systems

E2.  
Labels

E3.  
Pre-Printed  
& Write-On  
Markers

E4.  
Permanent  
Identification

E5.  
Lockout/  
Tagout  
& Safety  
Solutions

F.  
Index

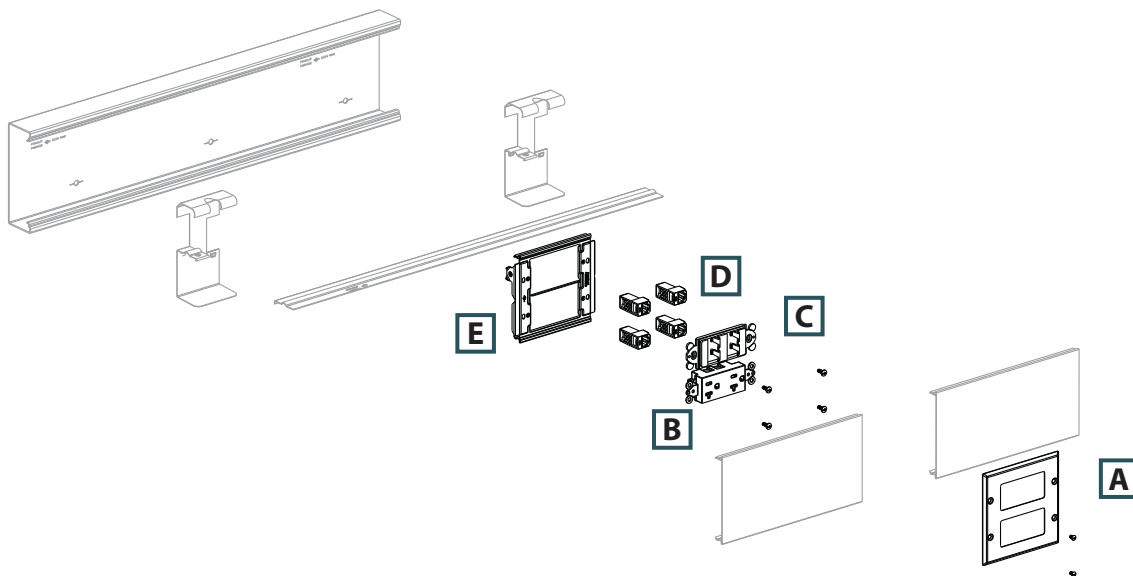

## Pan-Way® PMR40 Metal Raceway System

- c-UL-us listed and rated to 600 V; meets UL 5 and CSA22.2 No. 62-93 safety standards
- Raceway accepts standard double gang faceplates for increased termination options and reduced number of components
- System includes optional faceplates and fittings to support high performance Category 6A copper and fiber optic cabling terminations

- Full capacity 2 inch bend radius fittings provide necessary cable protection without restricting channel capacity
- Supplied with pre-punched mounting holes

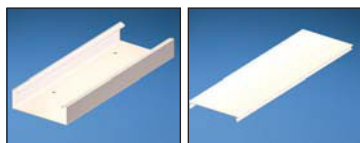
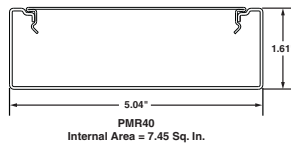

PMR40B

PMR40C

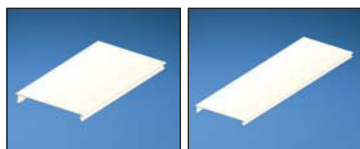

PMR40C\*\*\*

PMR40C\*\*\*

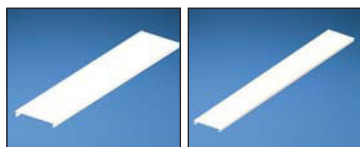

PMR40C\*\*\*

PMR40C\*\*\*



PMR40DW5

PMR40DC

Part Number	Part Description	Raceway Size	Color‡	Length Ft.	Std. Pkg. Qty.
<b>PMR40 Metal Raceway Base</b>					
<b>PMR40BWH10</b>	PMR40 raceway base available in 10' lengths. Supplied with pre-punched mounting holes.	5.04" x 1.61" (128.0mm x 40.9mm)	White	10	10
<b>PMR40 Metal Raceway Cover</b>					
<b>PMR40CWH5</b>	PMR40 raceway cover available in 5' lengths.	—	White	5	5
<b>PMR40 Metal Raceway Pre-cut Covers</b>					
<b>PMR40CWH7.75</b>	7.75" pre-cut cover. To be used with PMR40 raceway for mounting devices on 12" centers.	—	White	—	1
<b>PMR40CWH13.75</b>	13.75" pre-cut cover. To be used with PMR40 raceway for mounting devices on 18" centers.	—	White	—	1
<b>PMR40CWH19.75</b>	19.75" pre-cut cover. To be used with PMR40 raceway for mounting devices on 24" centers.	—	White	—	1
<b>PMR40CWH31.75</b>	31.75" pre-cut cover. To be used with PMR40 raceway for mounting devices on 36" centers.	—	White	—	1
<b>PMR40 Metal Raceway Divider Wall</b>					
<b>PMR40DW5</b>	PMR40 divider wall snaps into PMR40DC-X to create separate channels. Must use wire retainers to ensure channel separation per UL/CSA. Available in 5' lengths.	—	Gray	5	5
<b>PMR40 Metal Raceway Divider Wall Clip</b>					
<b>PMR40DC-X</b>	Divider wall clip. Required for supporting PMR40DW. 30" spacing recommended between clips.	—	Gray	—	10

‡For other colors replace WH (White) with AL (Almond). Order number of feet required in multiples of standard carton quantity. Order raceway base and cover separately.

## Pan-Way® PMR40 Metal Raceway Fittings

- PMR40 fittings are designed to exceed the TIA/EIA-568-B and 569-B required minimum bend radius for high performance copper and fiber optic cabling systems



PMR40SCWH-X

PMR40BC

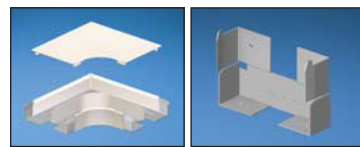

PMR40RA

PMR40SIC

Part Number	Part Description	Color‡	Std. Pkg. Qty.	Std. Ctn. Qty.
<b>PMR40SCWH-X</b>	Seam clip. Used to join sections of PMR40 raceway.	White	10	100
<b>PMR40BC</b>	Base coupler. Used to join sections of PMR40 raceway base.	Gray	10	100
<b>PMR40RAWH</b>	Right angle fitting. Used to join sections of PMR40 raceway at right angles.	White	1	10
<b>PMR40SIC</b>	Inside corner fitting w/out bend radius control. Used to join sections of PMR40 raceway at inside corners.	Gray	1	10

‡For other colors replace WH (White) with AL (Almond).

Table continues on page C2.6

A. System Overview

B1. Cable Ties

B2. Cable Accessories

B3. Stainless Steel Ties

C1. Wiring Duct

C2. Surface Raceway

C3. Abrasion Protection

C4. Cable Management

D1. Terminals

D2. Power Connectors

D3. Grounding Connectors

E1. Labeling Systems

E2. Labels

E3. Pre-Printed & Write-On Markers

E4. Permanent Identification

E5. Lockout/ Tagout & Safety Solutions

F. Index

A. System Overview

 **Pan-Way® PMR40 Metal Raceway Fittings (continued)**

B1. Cable Ties



**PMR40IC**



**PMR40I45E**

B2. Cable Accessories



**PMR40SOC**



**PMR40OC**

B3. Stainless Steel Ties

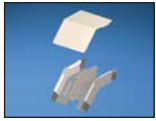

**PMR40E45E**



**PMR40T**

C1. Wiring Duct



**PMR40TD50**



**PMR40EC**

C2. Surface Raceway



**PMR40EE**



**PMR40TR**

C3. Abrasion Protection



**PMR40BF**



**PMR40PC**

D1. Terminals



**PMR40ICC**



**PMR40WR**

D2. Power Connectors



**PMR40DB50**



**PMR40DP50**

D3. Grounding Connectors



**PMR40FH2**



**PMR40FH4**

E1. Labeling Systems



**PMR40KH2**



**PMR40KH4**

E2. Labels



**RBFIWH**

E3. Pre-Printed & Write-On Markers

E4. Permanent Identification

E5. Lockout/Tagout & Safety Solutions

Part Number	Part Description	Color‡	Std. Pkg. Qty.	Std. Ctn. Qty.
<b>PMR40ICWH</b>	Inside corner fitting. Used to join sections of PMR40 raceway at inside corners.	White	1	10
<b>PMR40I45EWH</b>	Internal 45° elbow fitting. Used to join sections of PMR40 raceway at 45° inside corners.	White	1	10
<b>PMR40SOCWH</b>	Outside corner fitting without bend radius control. Used to join sections of PMR40 raceway at outside corners.	White	1	10
<b>PMR40OCWH</b>	Outside corner fitting. Used to join sections of PMR40 raceway at outside corners.	White	1	10
<b>PMR40E45EWH</b>	External 45° elbow fitting. Used to join sections of PMR40 raceway at 45° outside corners.	White	1	10
<b>PMR40TWH</b>	Tee fitting. Used to join sections of PMR40 raceway at tee intersections.	White	1	10
<b>PMR40TD50</b>	Tee divider insert for a 50/50 data/power split. Maintains a 50/50 channel separation for power and data applications.	Gray	1	10
<b>PMR40ECWH</b>	End cap fitting. Used to terminate or allow entry into PMR40 raceway. Breakouts for 1/2" conduit.	White	1	10
<b>PMR40EEWH</b>	Entrance end fitting. Breakouts for 3/4", 1", and 1 1/4" conduit which allows entry from ceiling or wall.	White	1	10
<b>PMR40TRWH</b>	WIREMOLD* to PMR40 transition fitting. In-line transition fitting from WIREMOLD* 4000 series to PMR40 raceway.	White	1	10
<b>PMR40BFWH</b>	Backfeed fitting. Allows cable entry through the back of the PMR40 raceway. Two round breakouts for 1/2", 3/4" and 1" conduit, two round breakouts for 3/4", 1", and 1 1/4" conduit and two 1 11/16" X 2 9/16" rectangular breakouts.	White	1	10
<b>PMR40PCWH</b>	Panel connector. To connect PMR40 raceway with surface type panel boxes.	White	1	10
<b>PMR40ICC</b>	Internal corner coupling.	Gray	1	10
<b>PMR40WR-X</b>	Wire retainer. Used to hold wires in place during installation.	Gray	10	100
<b>PMR40DB50</b>	Device mounting bracket 50/50 split. Used to mount NEMA standard single gang electrical outlets and communication devices with either screw-on or snap-on single gang faceplates.	Gray	1	10
<b>PMR40DP50WH</b>	PMR40 data plate for mounting data faceplates PMR40FH2, PMR40FH4, PMR40KH2 or PMR40KH4 when a 50/50 split channel is used in the PMR40 base. Includes data plate, 2.50" pre-cut cover, and offset divider wall.	White	1	10
<b>PMR40FH2WH</b>	Snap-on horizontal sloped communication faceplate. Accepts two Panduit® Mini-Com® Modules (not included). Note: Customer needs to purchase PMR40DP50WH.	White	1	10
<b>PMR40FH4WH</b>	Snap-on horizontal sloped communication faceplate. Accepts four Panduit® Mini-Com® Modules (not included). Note: Customer needs to purchase PMR40DP50WH.	White	1	10
<b>PMR40KH2WH</b>	Snap-on horizontal sloped communication faceplate. Accepts two Keystone modules (not included). Note: Customer needs to purchase PMR40DP50WH.	White	1	10
<b>PMR40KH4WH</b>	Snap-on horizontal sloped communication faceplate. Accepts four Keystone modules (not included). Note: Customer needs to purchase PMR40DP50WH.	White	1	10
<b>RBFIWH</b>	Rectangular blank faceplate. Snap-in insert for any NEMA standard rectangular opening in metal raceway faceplates. Reserves the location for future use.	White	1	10

‡For other colors replace WH (White) with AL (Almond).

\*WIREMOLD is a registered trademark of the Wiremold Co.

## Cable Fill Capacities for PMR40 Metal Raceway

This information is to be used as a guide in selecting the proper size raceway. The maximum amounts may vary according to the cable installation methods, straightness of cables, etc.



**A = 7.45 in.<sup>2</sup>**

**Cable fill #1:** Open channel without devices

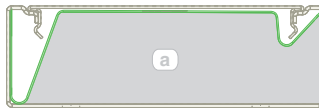

**A = 6.18 in.<sup>2</sup>**

**Cable fill #2:** Undivided, wire retainer only



**A = 2.64 in.<sup>2</sup>**

**B = 3.04 in.<sup>2</sup>**

**Cable fill #3:** Divided with wire retainer

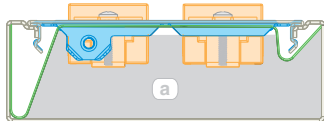

**A = 4.64 in.<sup>2</sup>**

**Cable fill #4:** Undivided with duplex receptacle on two sides

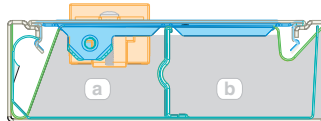

**A = 1.87 in.<sup>2</sup>**

**B = 2.84 in.<sup>2</sup>**

**Cable fill #5:** Divided with duplex receptacle on (A) side

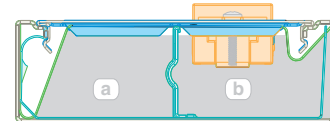

**A = 2.49 in.<sup>2</sup>**

**B = 2.21 in.<sup>2</sup>**

**Cable fill #6:** Divided with duplex receptacle on (B) side

**SPEC = 40% cable fill** – Recommended by TIA/EIA-569-B for design.

**MAX for 60% cable fill** – Recommended by TIA/EIA-569-B for unplanned additions.

**MAX for 40% power cable fill** – Based on available internal area.

Raceway Type and Configuration	Fill Area (in <sup>2</sup> )	Electrical Cables			Data Grade Cables		Data Grade Cables		Audio/Video	
		14 AWG	12 AWG	10 AWG	24 AWG/UTP CM		24 AWG/UTP CM		RG6	
		THHN/T90			Cat. 6		Cat. 6A			
		0.111	0.130	0.164	DIA. = 0.250		DIA. = 0.330		DIA. = 0.275	
		FILL			FILL		FILL		FILL	
		MAX 40%	MAX 40%	MAX 40%	SPEC 40%	MAX 60%	SPEC 40%	MAX 60%	SPEC 40%	MAX 60%
1. PMR40 - Undivided (base and cover)	7.45	307	224	140	60	91	34	52	50	75
2. PMR40 - Undivided, wire retainer only	6.18	255	186	117	50	75	28	43	41	62
3a. PMR40 - Divided, with wire retainer	2.64	109	79	50	21	32	12	18	17	26
	3b. PMR40 - Divided, with wire retainer	3.04	125	91	57	24	37	14	21	30
4. PMR40 - Undivided with duplex receptacle 2 sides	4.64	191	139	87	—	—	—	—	—	—
5a. PMR40 - Divided with duplex receptacle on (A) side	1.87	78	57	36	—	—	—	—	—	—
	5b. PMR40 - Divided with duplex receptacle on (A) side	2.84	—	—	—	23	34	13	19	19
6a. PMR40 - Divided with duplex receptacle on (B) side	2.49	—	—	—	20	30	11	17	16	25
	6b. PMR40 - Divided with duplex receptacle on (B) side	2.21	91	66	41	—	—	—	—	—

AWG dimensions represent typical outer cable diameter in inches.



A.  
System  
Overview

## PMR5/7 Raceway Roadmap

B1.  
Cable Ties

B2.  
Cable  
Accessories

B3.  
Stainless  
Steel Ties

C1.  
Wiring  
Duct

C2.  
Surface  
Raceway

C3.  
Abrasion  
Protection

C4.  
Cable  
Management

D1.  
Terminals

D2.  
Power  
Connectors

D3.  
Grounding  
Connectors

E1.  
Labeling  
Systems

E2.  
Labels

E3.  
Pre-Printed  
& Write-On  
Markers

E4.  
Permanent  
Identification

E5.  
Lockout/  
Tagout  
& Safety  
Solutions

F.  
Index

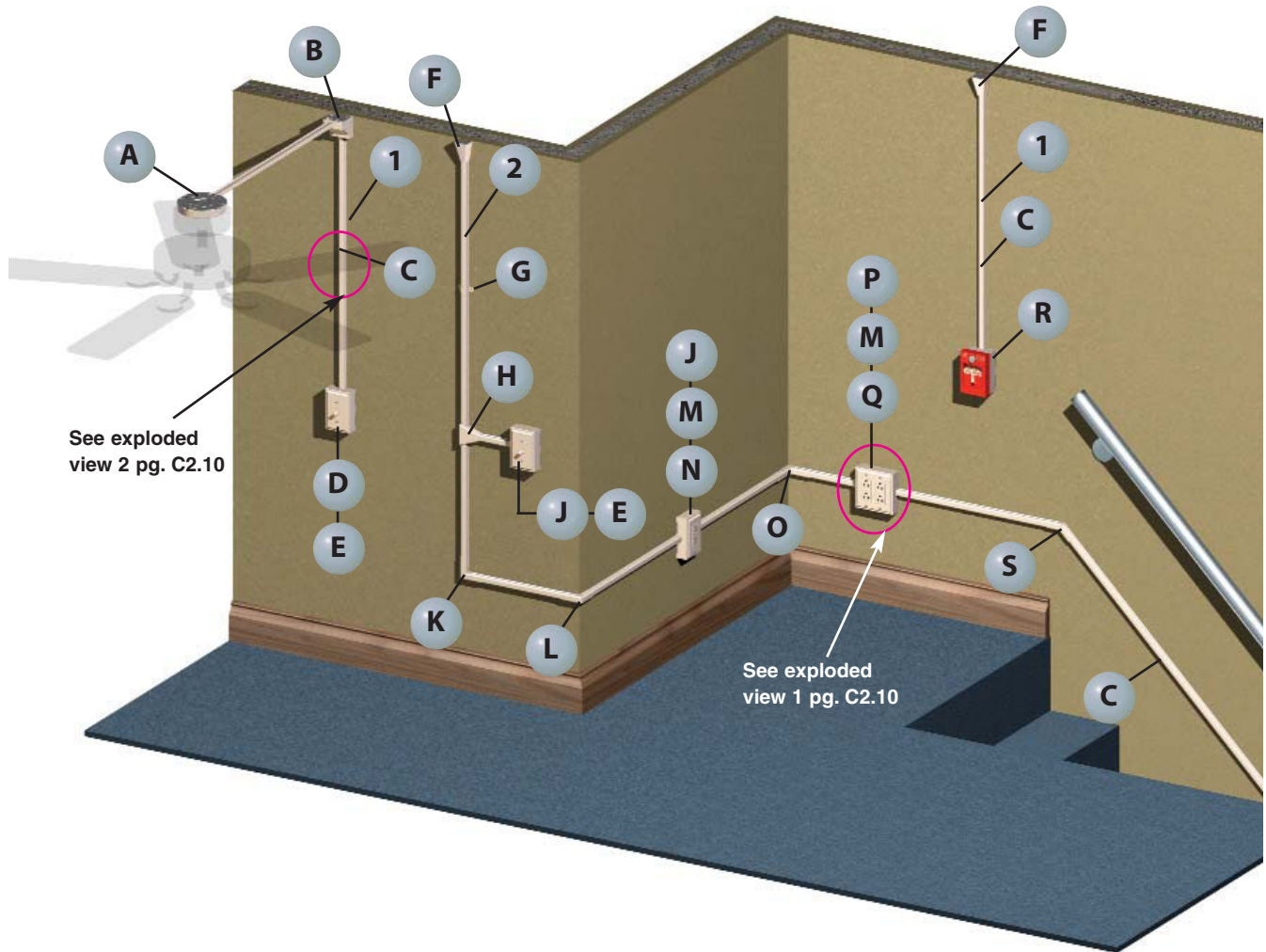

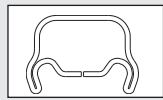

**1** PMR5\*\* – PMR5 Metal Raceway (page C2.11)

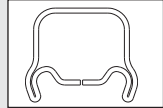

**2** PMR7\*\* – PMR7 Metal Raceway (page C2.11)



**A** PMR5738A\*\* – Round Fan/Fixture Box (page C2.16)

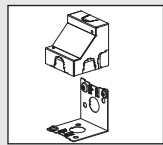

**B** PMR57CB\*\* – Corner Box (page C2.12)

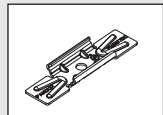

**C** PMR57SC-X – Supporting Clip (page C2.11)

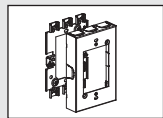

**D** PMR5751\*\* – Single Gang Extension Box (page C2.15)

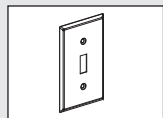

**E** MP1TS\*\* – Single Gang Toggle Switch Faceplate (page C2.17)

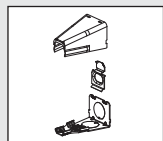

**F** PMR57EE\*\* – Entrance End Fitting (page C2.12)

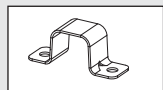

**G** PMR7MS\*\* – Mounting Strap (page C2.11)

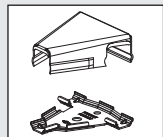

**H** PMR57T\*\* – Tee Fitting (page C2.12)

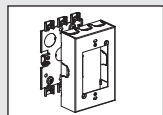

**J** PMR5747\*\* – Single Gang Shallow Outlet Box (page C2.15)

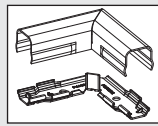

**K** PMR7RA\*\* – Right Angle Fitting (page C2.12)

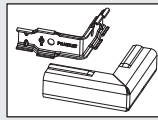

**L** PMR7OC\*\* – Outside Corner Fitting (page C2.12)

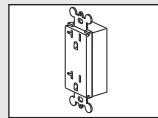

**M** ERU20\*\* – 20 A Specification Grade Rectangular Outlet (page C2.61)

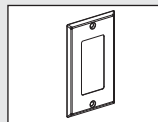

**N** MP1GR\*\* – Single Gang Rectangular Faceplate (page C2.17)

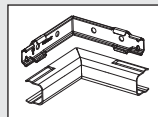

**O** PMR7IC\*\* – Inside Corner Fitting (page C2.12)

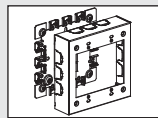

**P** PMR5747-2\*\* – Double Gang Shallow Outlet Box (page C2.15)

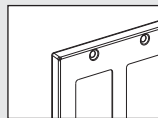

**Q** MP2GR\*\* – Double Gang Rectangular Faceplate (page C2.17)

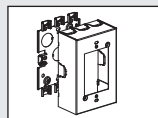

**R** PMR5748\*\* – Single Gang Outlet Box (page C2.15)

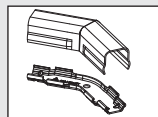

**S** PMR7DA\*\* – Diagonal 45° Angle Fitting (page C2.12)

A. System Overview

B1. Cable Ties

B2. Cable Accessories

B3. Stainless Steel Ties

C1. Wiring Duct

C2. Surface Raceway

C3. Abrasion Protection

C4. Cable Management

D1. Terminals

D2. Power Connectors

D3. Grounding Connectors

E1. Labeling Systems

E2. Labels

E3. Pre-Printed & Write-On Markers

E4. Permanent Identification

E5. Lockout/Tagout & Safety Solutions

F. Index

A.  
System  
Overview

## PMR5/PMR7 Configurations

B1.  
Cable Ties

### Exploded View 1

	Components Required	See page
A.	MP2GR = Double gang rectangular faceplate.	C2.17
B.	ERU20 = 20 A Specification rectangular outlet.	C2.61
C.	PMR5747-2 = Double gang deep outlet box.	C2.15

B2.  
Cable  
Accessories

B3.  
Stainless  
Steel Ties

C1.  
Wiring  
Duct

C2.  
Surface  
Raceway

C3.  
Abrasion  
Protection

C4.  
Cable  
Management

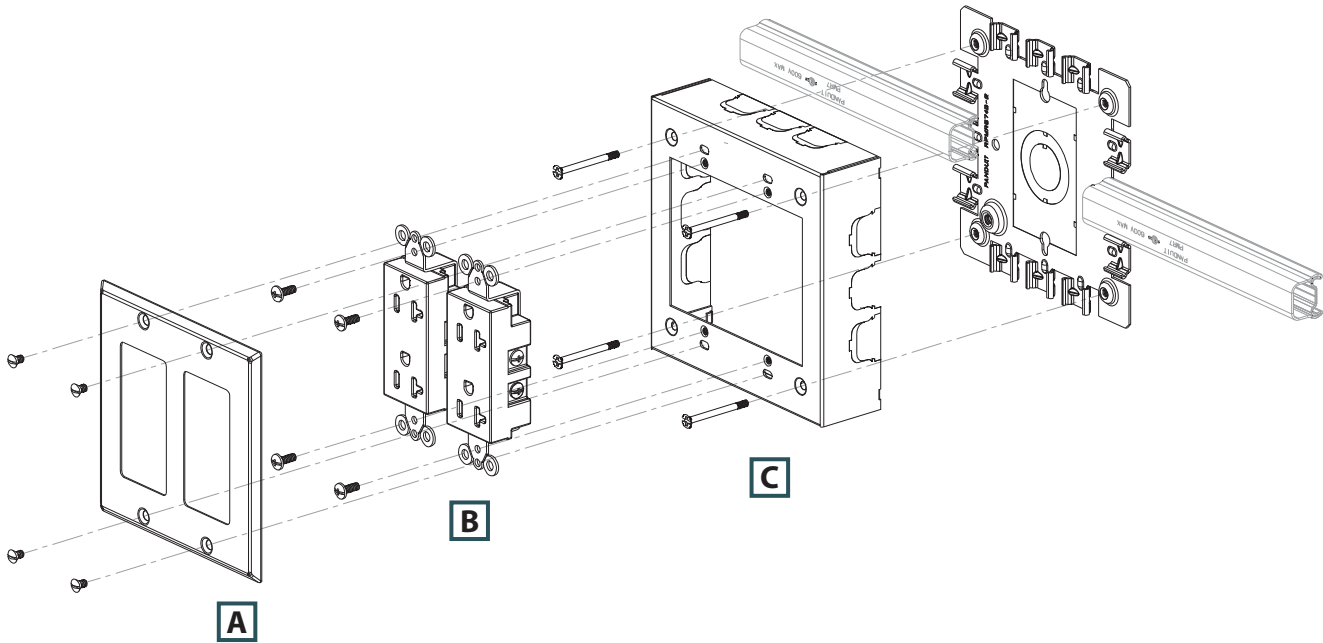

D1.  
Terminals

D2.  
Power  
Connectors

### Exploded View 2

	Components Required	See page
A.	PMR57SC-X = Supporting clip.	C2.11
B.	PMR7*** = PMR7 metal raceway.	C2.11

D3.  
Grounding  
Connectors

E1.  
Labeling  
Systems

E2.  
Labels

E3.  
Pre-Printed  
& Write-On  
Markers

E4.  
Permanent  
Identification

E5.  
Lockout/  
Tagout  
& Safety  
Solutions

F.  
Index

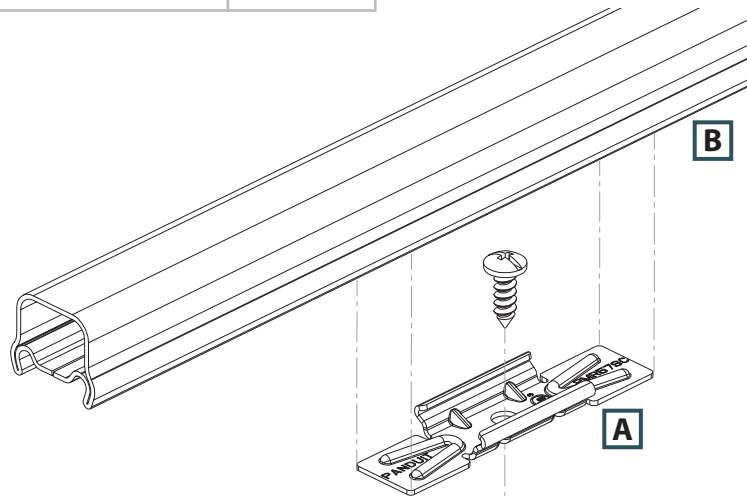

## c-UL-us Pan-Way® PMR5/PMR7 Metal Raceway System

- c-UL-us listed and rated to 600 V; meets UL 5 and CSA22.2 No. 62-93 safety standards
- Raceway system features a patent pending bonding design that provides full continuity of the ground path between fittings and channel, for increased electrical safety
- System components incorporate a unique snap mount assembly method for faster installation

- Fittings and mounts can be attached using various types and sizes of fasteners, eliminating the requirements of using only flat head style screws
- One-piece channel construction eliminates the problem of channel separation, associated with competitive two-piece designs, saving installation time

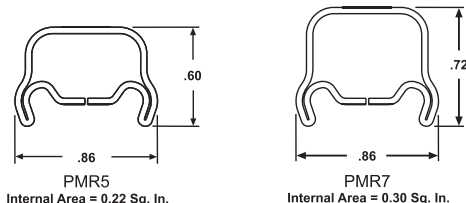

PMR5

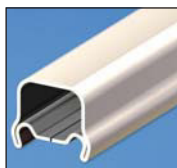

PMR7



PMR57SC

PMR57JC



PMR57GC

PMR5WPB  
PMR7WPB



PMR5MS  
PMR7MS

Part Number	Part Description	Raceway Size	Color‡	Length (Ft.)	Std. Pkg. Qty.	Std. Ctn. Qty.
<b>PMR5 Metal Raceway</b>						
<b>PMR5WH5</b>	One-piece single channel metal surface raceway. Available in 5' lengths.	0.86" x 0.60" (21.8mm x 15.2mm)	White	5	5	50
<b>PMR5WH10</b>	One-piece single channel metal surface raceway. Available in 10' lengths.	0.86" x 0.60" (21.8mm x 15.2mm)	White	10	10	100
<b>PMR7 Metal Raceway</b>						
<b>PMR7WH5</b>	One-piece single channel metal surface raceway. Available in 5' lengths.	0.86" x 0.72" (21.8mm x 18.3mm)	White	5	5	50
<b>PMR7WH10</b>	One-piece single channel metal surface raceway. Available in 10' lengths.	0.86" x 0.72" (21.8mm x 18.3mm)	White	10	10	100
<b>PMR7 Metal Raceway</b>						
<b>PMR57SC-X</b>	Supporting clip used to support lengths of PMR5 or PMR7 raceway at any desired point.	—	Gray	—	10	100
<b>PMR7 Metal Raceway</b>						
<b>PMR57JC-X</b>	Joint coupling used to join two lengths of PMR5 or PMR7 raceway.	—	Gray	—	10	100
<b>PMR7 Metal Raceway</b>						
<b>PMR57GC-X</b>	Ground clip used to provide additional grounding of raceway or to ground remote installations. For use with PMR5 or PMR7 raceway.	—	Gray	—	10	100
<b>Supporting Clip</b>						
<b>PMR5WPB-X</b>	Bushing used to protect wires from abrasion. For use with PMR5 raceway.	—	Gray	—	10	100
<b>PMR7WPB-X</b>	Bushing used to protect wires from abrasion. For use with PMR7 raceway.	—	Gray	—	10	100
<b>PMR7 Metal Raceway</b>						
<b>PMR5MSWH-X</b>	Mounting strap for use with PMR5 raceway.	—	White	—	10	100
<b>PMR7MSWH-X</b>	Mounting strap for use with PMR7 raceway.	—	White	—	10	100

‡For other colors replace WH (White) with AL (Almond).

A.  
System  
Overview

B1.  
Cable  
Ties

B2.  
Cable  
Accessories

B3.  
Stainless  
Steel Ties

C1.  
Wiring  
Duct

C2.  
Surface  
Raceway

C3.  
Abrasion  
Protection

C4.  
Cable  
Management

D1.  
Terminals

D2.  
Power  
Connectors

D3.  
Grounding  
Connectors

E1.  
Labeling  
Systems

E2.  
Labels

E3.  
Pre-Printed  
& Write-On  
Markers

E4.  
Permanent  
Identification

E5.  
Lockout/  
Tagout  
& Safety  
Solutions

F.  
Index

A. System Overview

B1. Cable Ties

B2. Cable Accessories

B3. Stainless Steel Ties

C1. Wiring Duct

C2. Surface Raceway

C3. Abrasion Protection

C4. Cable Management

D1. Terminals

D2. Power Connectors

D3. Grounding Connectors

E1. Labeling Systems

E2. Labels

E3. Pre-Printed & Write-On Markers

E4. Permanent Identification

E5. Lockout/Tagout & Safety Solutions

F. Index



## Pan-Way® PMR5/PMR7 Metal Raceway Fittings

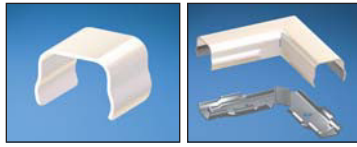

**PMR5CC**  
**PMR7CC**



**PMR5RA**  
**PMR7RA**

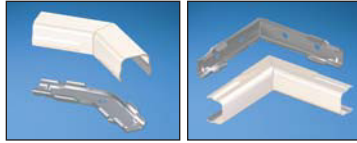

**PMR5DA**  
**PMR7DA**



**PMR5IC**  
**PMR7IC**



**PMR5OC**  
**PMR7OC**



**PMR5LTE**



**PMR5RTE**

**PMR57T**



**PMR57EE**

**PMR57AOC**



**PMR57CB**

**PMR57TR**  
**PMR7TR**



**PMR57EBC**

**PMR57ECC**



**PMR57JBC50**  
**PMR57JBC75**

**PMR57CC50**  
**PMR57CC75**

Part Number	Part Description	Color‡	Std. Pkg. Qty.	Std. Ctn. Qty.
<b>PMR5CCWH-X</b>	Coupler fitting for use with PMR5 raceway.	White	10	100
<b>PMR7CCWH-X</b>	Coupler fitting for use with PMR7 raceway.	White	10	100
<b>PMR5RAWH</b>	Right angle fitting for use with PMR5 raceway.	White	1	10
<b>PMR7RAWH</b>	Right angle fitting for use with PMR7 raceway.	White	1	10
<b>PMR5DAWH</b>	Diagonal 45° angle fitting for use with PMR5 raceway.	White	1	10
<b>PMR7DAWH</b>	Diagonal 45° angle fitting for use with PMR7 raceway.	White	1	10
<b>PMR5ICWH</b>	Inside corner fitting for use with PMR5 raceway.	White	1	10
<b>PMR7ICWH</b>	Inside corner fitting for use with PMR7 raceway.	White	1	10
<b>PMR5OCWH</b>	Outside corner fitting for use with PMR5 raceway.	White	1	10
<b>PMR7OCWH</b>	Outside corner fitting for use with PMR7 raceway.	White	1	10
<b>PMR57LTEWH</b>	Left twisted elbow for 90° twist with 90° turn. For double turn at right angles from one surface to another, such as a flat run on a sidewall to a flat run on a ceiling. For use with PMR5 and PMR7 raceway.	White	1	10
<b>PMR57RTEWH</b>	Right twisted elbow for 90° twist with 90° turn. For double turn at right angles from one surface to another, such as a flat run on a sidewall to a flat run on a ceiling. For use with PMR5 and PMR7 raceway.	White	1	10
<b>PMR57TWH</b>	Tee fitting for use with PMR5 or PMR7 raceway.	White	1	10
<b>PMR57EEWH</b>	Entrance end fitting. 1/2" conduit breakouts allows entry of PMR5 or PMR7 raceway from a box, the ceiling, or a wall. Spring steel bushing included for use when connecting to a box.	White	1	10
<b>PMR57AOCWH</b>	Adjustable offset allows PMR5 or PMR7 to be mounted flush to wall when connected to surface type panel boxes. Adjustable between 5/8" and 1 3/8" from surface to center of conduit. 1/2" chase nipple and locknut included.	White	1	10
<b>PMR57CBWH</b>	Corner box for connecting PMR5 or PMR7 raceway. Each leg has 1/2" conduit breakouts and room for splicing.	White	1	10
<b>PMR57TRWH</b>	WIREMOLD* to PMR5 transition fitting. In-line transition fitting from WIREMOLD* 500 series to PMR5 raceway.	White	1	10
<b>PMR77TRWH</b>	WIREMOLD* to PMR7 Transition fitting. In-line transition fitting from WIREMOLD* 700 series to PMR7 raceway.	White	1	10
<b>PMR57EBCWH</b>	Elbow box connector used to connect PMR5 or PMR7 raceway to boxes at a right angle. Breakouts for 1/2" conduit.	White	1	10
<b>PMR57ECCWH</b>	Elbow conduit connector used to connect PMR5 or PMR7 raceway to conduit at a right angle. Breakouts for 1/2" conduit.	White	1	10
<b>PMR57JBC50-X</b>	Junction box connector used to connect PMR5 or PMR7 raceway to boxes with 1/2" conduit breakout.	White	10	100
<b>PMR57JBC75-X</b>	Junction box connector used to connect PMR5 or PMR7 raceway to boxes with 3/4" conduit breakout.	White	10	100
<b>PMR57CC50-X</b>	Conduit connector used to connect PMR5 or PMR7 raceway to 1/2" conduit.	White	10	100
<b>PMR57CC75-X</b>	Conduit connector used to connect PMR5 or PMR7 raceway to 3/4" conduit.	White	10	100

‡For other colors replace WH (White) with AL (Almond).

\*WIREMOLD is a registered trademark of the Wiremold Co.

**cUL<sup>us</sup> PMR5 and PMR7 Raceway Accessories**



**PMR57MRT**



**PMRTUP\*\***

Part Number	Part Description	Color	Std. Pkg. Qty.	Std. Ctn. Qty.
<b>PMR57MRT</b>	Metal raceway tool. To aid in the installation and removal of PMR5 and PMR7 metal raceway base sections.	Black	1	10
<b>PMRTUPAL</b>	Touch-up paint pen. Used to repair areas of metal raceway where paint has been removed or damaged.	—	1	10
<b>PMRTUPWH</b>	Touch-up paint pen. Used to repair areas of metal raceway where paint has been removed or damaged.	—	1	10

A. System Overview

B1. Cable Ties

B2. Cable Accessories

B3. Stainless Steel Ties

C1. Wiring Duct

C2. Surface Raceway

C3. Abrasion Protection

C4. Cable Management

D1. Terminals

D2. Power Connectors

D3. Grounding Connectors

E1. Labeling Systems

E2. Labels

E3. Pre-Printed & Write-On Markers

E4. Permanent Identification

E5. Lockout/Tagout & Safety Solutions

F. Index

A. System Overview

## Cable Fill Capacities for PMR5/PMR7 Metal Raceway

B1. Cable Ties

This information is to be used as a guide in selecting the proper size raceway. The maximum amounts may vary according to the cable installation methods, straightness of cables, etc.

B2. Cable Accessories

B3. Stainless Steel Ties

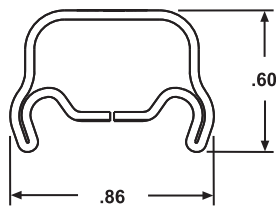

PMR5

$$A = .22 \text{ in.}^2$$

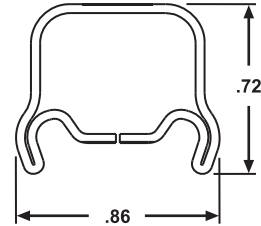

PMR7

$$A = .30 \text{ in.}^2$$

C1. Wiring Duct

C2. Surface Raceway

C3. Abrasion Protection

C4. Cable Management

**SPEC = 40% cable fill** – The recommended design in cable capacity, leaves room for future moves, adds, and changes.

**MAX for Data = 60% cable fill** – The maximum cable quantity based on cable interweaving and packing factors.

D1. Terminals

D2. Power Connectors

D3. Grounding Connectors

Raceway Type and Configuration	Fill Area (In. <sup>2</sup> )	Electrical Cables			Data Grade Cables		Data Grade Cables		Audio/Video		Fiber Optic Cable	
		14 AWG	12 AWG	10 AWG	24 AWG/UTP CM		24 AWG/UTP CM		RG6		2 Strand	
		THHN/T90			Category 6		Category 6A		Dia. = 0.275		Dia. = 0.175	
		0.111	0.130	0.164	Dia. = 0.250		Dia. = 0.330		FILL		FILL	
		MAX	MAX	MAX	SPEC	MAX	SPEC	MAX	SPEC	MAX	SPEC	MAX
PMR5	0.22	9	6	4	1	2	1	1	1	2	3	5
PMR7	0.30	12	8	5	2	3	1	2	2	3	4	7

AWG dimensions represent typical outer cable diameter in inches.

E1. Labeling Systems

E2. Labels

E3. Pre-Printed & Write-On Markers

E4. Permanent Identification

E5. Lockout/Tagout & Safety Solutions

F. Index

 **Pan-Way® Metal Raceway Boxes**

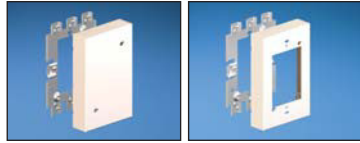

PMR5760

PMR5751



PMR5751-2

PMR5751-3

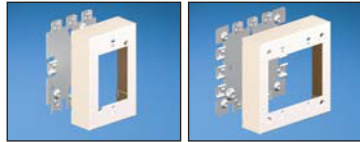

PMR5747

PMR5747-2

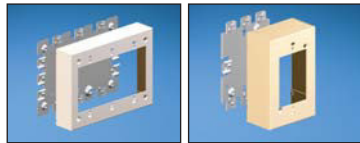

PMR5747-3

PMR5748

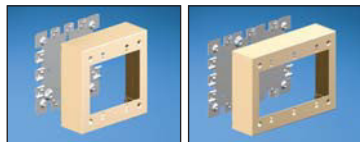

PMR5748-2

PMR5748-3

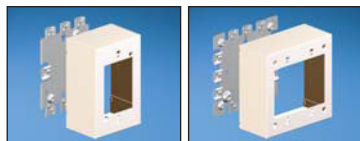

PMR5744S

PMR5744S-2

Part Number	Part Description	Color‡	Std. Pkg. Qty.	Std. Ctn. Qty.
PMR5760WH	Single gang blank extension box. For use with Pan-Way® PMR5 or PMR7 Raceway. 4.92"L x 3.17"W x 0.94"H (125.0mm x 80.5mm x 23.8mm)	White	1	10
PMR5751WH	Single gang extension box. Box accepts Pan-Way® Faceplates or any NEMA standard single gang faceplate. For use with Pan-Way® PMR5 or PMR7 Raceway. 4.92"L x 3.17"W x .94"H (125.0mm x 80.5mm x 23.8mm)	White	1	10
PMR5751-2WH	Double gang extension box. Box accepts Pan-Way® Faceplates or any standard double gang faceplate. For use with Pan-Way® PMR5 or PMR7 Raceway. 4.92"L x 4.92"W x .94"H (125.0mm x 125.0mm x 23.8mm)	White	1	10
PMR5751-3WH	Three gang extension box. Box accepts Pan-Way® Faceplates or any standard three gang faceplate. For use with Pan-Way® PMR5 or PMR7 Raceway. 4.92"L x 6.72"W x .94"H (125.0mm x 170.7mm x 23.8mm)	White	1	10
PMR5747WH	Single gang shallow outlet box. Box accepts Pan-Way® Faceplates or any NEMA standard single gang faceplate. For use with Pan-Way® PMR5 or PMR7 Raceway. Breakouts for 1/2" conduit. 4.92"L x 3.17"W x 1.38"H (125.0mm x 80.5mm x 34.9mm)	White	1	10
PMR5747-2WH	Double gang shallow outlet box. Box accepts Pan-Way® Faceplates or any standard double gang faceplate. For use with Pan-Way® PMR5 or PMR7 Raceway. Breakouts for 1/2" and 1" conduit. 4.92"L x 4.92"W x 1.38"H (125.0mm x 125.0mm x 34.9mm)	White	1	10
PMR5747-3WH	Three gang shallow outlet box. Box accepts Pan-Way® Faceplates or any standard three gang faceplate. For use with Pan-Way® PMR5 or PMR7 Raceway. Breakouts for 1/2" conduit. 4.92"L x 6.72"W x 1.38"H (125.0mm x 170.7mm x 34.9mm)	White	1	10
PMR5748WH	Single gang outlet box. Box accepts Pan-Way® Faceplates or any NEMA standard single gang faceplate. For use with Pan-Way® PMR5 or PMR7 Raceway. Breakouts for 1/2" conduit. 4.92"L x 3.17"W x 1.75"H (125.0mm x 80.5mm x 44.5mm)	White	1	10
PMR5748-2WH	Double gang outlet box. Box accepts Pan-Way® Faceplates or any standard double gang faceplate. For use with Pan-Way® PMR5 or PMR7 Raceway. Breakouts for 1/2" and 1" conduit. 4.92"L x 4.92"W x 1.75"H (125.0mm x 125.0mm x 44.5mm)	White	1	10
PMR5748-3WH	Three gang outlet box. Box accepts Pan-Way® Faceplates or any standard three gang faceplate. For use with Pan-Way® PMR5 or PMR7 Raceway. Breakouts for 1/2" conduit. 4.92"L x 6.72"W x 1.75"H (125.0mm x 170.7mm x 44.5mm)	White	1	10
PMR5744SWH	Single gang intermediate outlet box. Box accepts Pan-Way® Faceplates or any NEMA standard single gang faceplate. For use with Pan-Way® PMR5 or PMR7 Raceway. Breakouts for 1/2" conduit. 4.92"L x 3.17"W x 2.25"H (125.0mm x 80.5mm x 57.2mm)	White	1	10
PMR5744S-2WH	Double gang intermediate outlet box. Box accepts Pan-Way® Faceplates or any standard double gang faceplate. For use with Pan-Way® PMR5 or PMR7 Raceway. Breakouts for 1/2" and 1" conduit. 4.92"L x 4.92"W x 2.25"H (125.0mm x 125.0mm x 57.2mm)	White	1	10

‡For other colors replace WH (White) with AL (Almond).

Table continues on page C2.16

A.  
System  
Overview

B1.  
Cable Ties

B2.  
Cable  
Accessories

B3.  
Stainless  
Steel Ties

C1.  
Wiring  
Duct

C2.  
Surface  
Raceway

C3.  
Abrasion  
Protection

C4.  
Cable  
Management

D1.  
Terminals

D2.  
Power  
Connectors

D3.  
Grounding  
Connectors

E1.  
Labeling  
Systems

E2.  
Labels

E3.  
Pre-Printed  
& Write-On  
Markers

E4.  
Permanent  
Identification

E5.  
Lockout/  
Tagout  
& Safety  
Solutions

F.  
Index



A. System Overview

**cUL<sub>us</sub> Pan-Way® Metal Raceway Boxes (continued)**

B1. Cable Ties

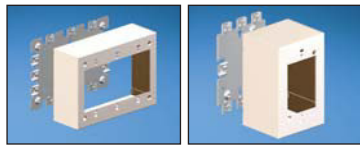

PMR5744S-3

PMR5744

B2. Cable Accessories

B3. Stainless Steel Ties

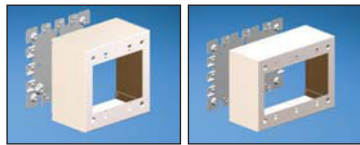

PMR5744-2

PMR5744-3

C1. Wiring Duct

C2. Surface Raceway



PMR5738

PMR5738A

C3. Abrasion Protection

C4. Cable Management



PMR5739

PMR5737

D1. Terminals

D2. Power Connectors



PMR5737A

PMR5739A

D3. Grounding Connectors

E1. Labeling Systems



PMR5736

PMR5752

E2. Labels

E3. Pre-Printed & Write-On Markers



PMR5753

E4. Permanent Identification

E5. Lockout/Tagout & Safety Solutions

F. Index

Part Number	Part Description	Color‡	Std. Pkg. Qty.	Std. Ctn. Qty.
PMR5744S-3WH	Three gang intermediate outlet box. Box accepts Pan-Way® Faceplates or any standard three gang faceplate. For use with Pan-Way® PMR5 or PMR7 Raceway. Breakouts for 1/2" conduit. 4.92"L x 6.72"W x 2.25"H (125.0mm x 170.7mm x 57.2mm)	White	1	10
PMR5744WH	Single gang deep outlet box. Box accepts Pan-Way® Faceplates or any NEMA standard single gang faceplate. For use with Pan-Way® PMR5 or PMR7 Raceway. Breakouts for 1/2" conduit. 4.92"L x 3.17"W x 2.75"H (125.0mm x 80.5mm x 69.9mm)	White	1	10
PMR5744-2WH	Double gang deep outlet box. Box accepts Pan-Way® Faceplates or any standard double gang faceplate. For use with Pan-Way® PMR5 or PMR7 Raceway. Breakouts for 1/2" and 1" conduit. 4.92"L x 4.92"W x 2.75"H (125.0mm x 80.5mm x 69.9mm)	White	1	10
PMR5744-3WH	Three gang deep outlet box. Box accepts Pan-Way® Faceplates or any standard three gang faceplate. For use with Pan-Way® PMR5 or PMR7 Raceway. Breakouts for 1/2" conduit. 4.92"L x 6.72"W x 2.75"H (125.0mm x 170.7mm x 69.9mm)	White	1	10
PMR5738WH	Round fixture box with solid base is c-UL-us rated to accept devices up to 50 lbs. For use with Pan-Way® PMR5 or PMR7 Raceway. Base has four 1/2" conduit breakouts. Dia.= 4.77"D x 1.00"H (121.2mm x 25.4mm)	White	1	10
PMR5738AWH	Round fan or fixture box with solid base is c-UL-us rated to accept devices up to 50 lbs. For use with Pan-Way® PMR5 or PMR7 Raceway. Base has four 1/2" conduit breakouts. Dia. = 5.53"D x 1.00"H (140.5mm x 25.4mm)	White	1	10
PMR5739WH	Round fixture box with solid base is c-UL-us rated to accept devices up to 50 lbs. For use with Pan-Way® PMR5 or PMR7 Raceway. Base has four 1/2" conduit breakouts. Dia. = 6.37"D x 1.00"H (161.8mm x 25.4mm)	White	1	10
PMR5737WH	Round extension box with open base is c-UL-us rated to accept devices up to 50 lbs. For use with Pan-Way® PMR5 or PMR7 Raceway. Dia. = 4.76"D x 1.00"H (121.0mm x 25.4mm)	White	1	10
PMR5737AWH	Round extension box with open base is c-UL-us rated to accept devices up to 50 lbs. For use with Pan-Way® PMR5 or PMR7 Raceway. Dia. = 5.53"D x 1.00"H (140.5mm x 25.4mm)	White	1	10
PMR5739AWH	Round extension box with open base is c-UL-us rated to accept devices up to 50 lbs. For use with Pan-Way® PMR5 or PMR7 Raceway. Dia. = 6.37"D x 1.00"H (161.8mm x 25.4mm)	White	1	10
PMR5736WH	Round Blank Faceplate for use with Pan-Way PMR5 or PMR7 Round Outlet Boxes: PMR5737, PMR5737A, PMR5738, PMR5738A, PMR5739 and PMR5739A. Knockout for 1/2" conduit. Dia. = 4.25"D x 0.45"H (108.0mm x 11.5mm).	White	1	50
PMR5752RD	Alarm device box. Box accepts alarm devices and safety signals designed to fit 4" square back boxes. For use with Pan-Way® PMR5 or PMR7 Raceway. Breakouts for 1/2" and 1" conduit. 4.92"L x 4.92"W x 1.42" H (125.0mm x 125.0mm x 36.1mm) <b>Available in red only.</b>	Red	1	10
PMR5753RD	Deep alarm device box. Box accepts alarm devices and safety signals designed to fit 4" square back boxes. For use with Pan-Way® PMR5 or PMR7 Raceway. Breakouts for 1/2" and 1" conduit. 4.92"L x 4.92"W x 2.80"H (125.0mm x 125.0mm x 71.0mm) <b>Available in red only.</b>	Red	1	10

‡For other colors replace WH (White) with AL (Almond).



## Pan-Way® Metal Raceway Faceplates

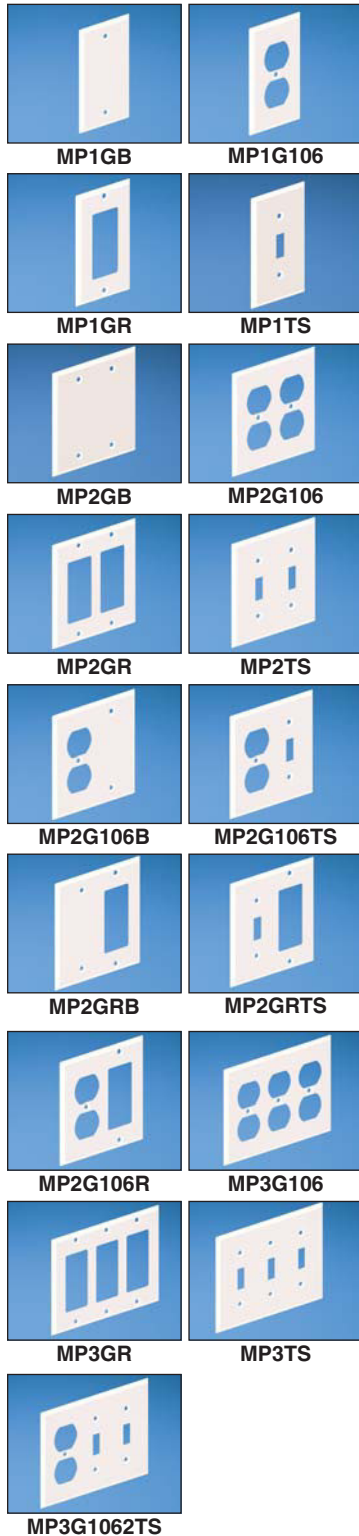

Part Number	Part Description	Color‡	Std. Pkg. Qty.	Std. Ctn. Qty.
MP1GBWH	Metal single gang blank faceplate.	White	1	10
MP1G106WH	Metal single gang 106 duplex faceplate. Covers one NEMA standard 106 duplex electrical outlet or one standard 106 communication module frame.	White	1	10
MP1GRWH	Metal single gang rectangular faceplate. Covers one NEMA standard rectangular electrical outlet or one standard rectangular communication module frame.	White	1	10
MP1TSWH	Metal single gang toggle switch faceplate. Covers one NEMA standard toggle switch.	White	1	10
MP2GBWH	Metal double gang blank faceplate.	White	1	10
MP2G106WH	Metal double gang 106 duplex faceplate. Covers two NEMA standard 106 duplex electrical outlets or two standard 106 communication module frames.	White	1	10
MP2GRWH	Metal double gang rectangular faceplate. Covers two NEMA standard rectangular electrical outlets or two standard rectangular communication module frames.	White	1	10
MP2TSWH	Metal double gang toggle switch faceplate. Covers two NEMA standard toggle switches.	White	1	10
MP2G106BWH	Metal double gang 106 duplex/blank faceplate. Covers one NEMA standard 106 duplex electrical outlet or standard 106 communication module frame with opposite side blank.	White	1	10
MP2G106TSWH	Metal double gang 106 duplex/toggle switch faceplate. Covers one NEMA standard 106 duplex outlet or standard 106 communication module frame and one NEMA standard toggle switch.	White	1	10
MP2GRBWH	Metal double gang rectangular/blank faceplate. Covers one NEMA standard rectangular electrical outlet or standard rectangular communication module frame with opposite side blank.	White	1	10
MP2GRTSWH	Metal double gang rectangular/toggle switch faceplate. Covers one NEMA standard rectangular electrical outlet or standard rectangular communication module frame and one NEMA standard toggle switch.	White	1	10
MP2G106RWH	Metal double gang 106 duplex/rectangular faceplate. Covers one NEMA standard 106 duplex outlet or standard 106 communication module frame and one NEMA standard rectangular outlet or standard rectangular communication module frame.	White	1	10
MP3G106WH	Metal three gang 106 duplex faceplate. Covers three NEMA standard 106 duplex electrical outlets or three standard 106 communication module frames.	White	1	10
MP3GRWH	Metal three gang rectangular faceplate. Covers three NEMA standard rectangular electrical outlets or three standard rectangular communication module frames.	White	1	10
MP3TSWH	Metal three gang toggle switch faceplate. Covers three NEMA standard toggle switches.	White	1	10
MP3G1062TSWH	Metal three gang 106 duplex/two toggle switch faceplate. Covers one NEMA standard 106 duplex electrical outlet or one standard 106 communication module frame and two NEMA standard toggle switches.	White	1	10

‡For other colors replace WH (White) with AL (Almond).

A.  
System  
Overview

B1.  
Cable Ties

B2.  
Cable  
Accessories

B3.  
Stainless  
Steel Ties

C1.  
Wiring  
Duct

C2.  
Surface  
Raceway

C3.  
Abrasion  
Protection

C4.  
Cable  
Management

D1.  
Terminals

D2.  
Power  
Connectors

D3.  
Grounding  
Connectors

E1.  
Labeling  
Systems

E2.  
Labels

E3.  
Pre-Printed  
& Write-On  
Markers

E4.  
Permanent  
Identification

E5.  
Lockout/  
Tagout  
& Safety  
Solutions

F.  
Index

A. System Overview

B1. Cable Ties

B2. Cable Accessories

B3. Stainless Steel Ties

## PAN-WAY® NON-METALLIC SURFACE RACEWAY

Pan-Way® Non-Metallic Surface Raceways provide maximum flexibility for routing, protecting, concealing and terminating high performance copper, voice, video, fiber optic and power cabling. Panduit surface raceways are designed with attention to function and aesthetics to blend with any décor. Panduit surface raceway systems include transition fittings that facilitate seamless integration of one Panduit surface raceway system to another. Panduit Surface Raceway Systems work with all Panduit® Mini-Com® Modules for complete connectivity possibilities.

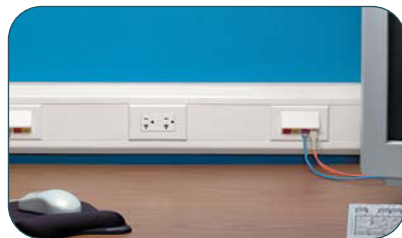

- Aesthetically pleasing
- Lightweight
- Tamper resistant
- Bend radius control
- Resists dents and conceals scratches and chips
- Ease of modifications and additions
- Lowest installed cost

C1. Wiring Duct

C2. Surface Raceway

C3. Abrasion Protection

C4. Cable Management

D1. Terminals

D2. Power Connectors

D3. Grounding Connectors

E1. Labeling Systems

E2. Labels

E3. Pre-Printed & Write-On Markers

E4. Permanent Identification

E5. Lockout/Tagout & Safety Solutions

F. Index

Panduit surface raceway provides a variety of choices when selecting data and electrical terminations. All Panduit surface raceways include a full complement of fittings that are designed to maintain the proper bend radius control required for high performance copper and fiber optic cabling systems. All of the raceways accept either NEMA 70mm standard screw-on faceplates or superior Pan-Way® Snap-On Faceplates. Panduit surface raceway systems work with all Panduit® Mini-Com® Modules, for complete connectivity possibilities.