

## 阅读申明

- 1.本站收集的数据手册和产品资料都来自互联网，版权归原作者所有。如读者和版权方有任何异议请及时告之，我们将妥善解决。
- 2.本站提供的中文数据手册是英文数据手册的中文翻译，其目的是协助用户阅读，该译文无法自动跟随原稿更新，同时也可能存在翻译上的不当。建议读者以英文原稿为参考以便获得更精准的信息。
- 3.本站提供的产品资料，来自厂商的技术支持或者使用者的心得体会等，其内容可能存在描述上的差异，建议读者做出适当判断。
- 4.如需与我们联系，请发邮件到marketing@iczoom.com，主题请标有“数据手册”字样。

## Read Statement

1. The datasheets and other product information on the site are all from network reference or other public materials, and the copyright belongs to the original author and original published source. If readers and copyright owners have any objections, please contact us and we will deal with it in a timely manner.
2. The Chinese datasheets provided on the website is a Chinese translation of the English datasheets. Its purpose is for reader's learning exchange only and do not involve commercial purposes. The translation cannot be automatically updated with the original manuscript, and there may also be improper translations. Readers are advised to use the English manuscript as a reference for more accurate information.
3. All product information provided on the website refer to solutions from manufacturers' technical support or users the contents may have differences in description, and readers are advised to take the original article as the standard.
4. If you have any questions, please contact us at marketing@iczoom.com and mark the subject with "Datasheets" .

# High Voltage Ceramic Capacitors DC10-40kV

**HIGH VOLTAGE  
CERAMIC  
CAPACITORS**

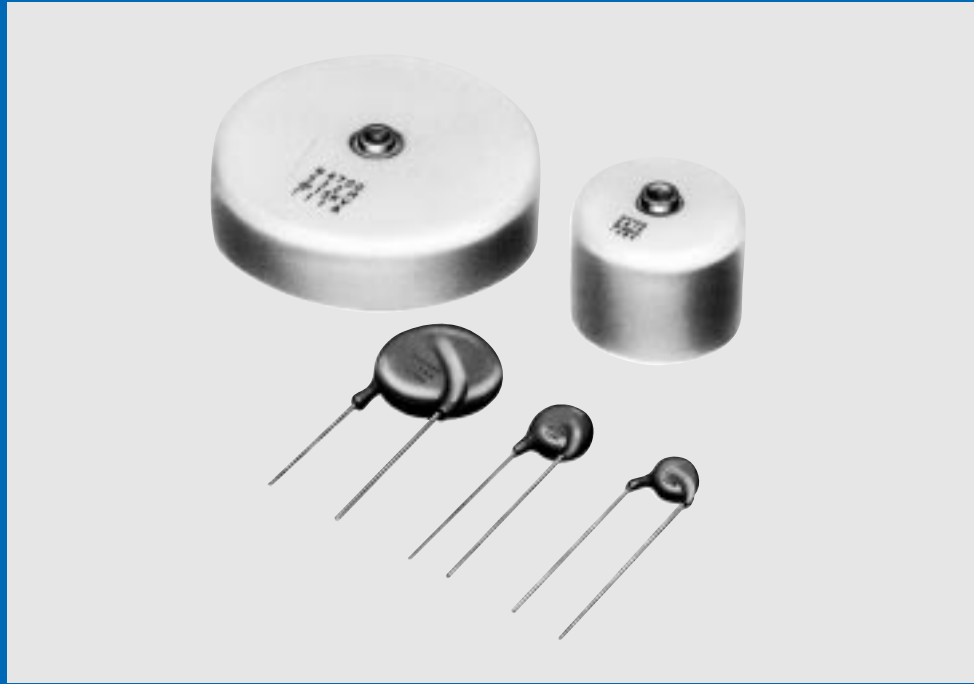

# CONTENTS

1

<b>Part Numbering</b>	2
<b>1 Radial Lead Type DHR Series (DC10-15kV)</b>	3
● Specifications and Test Methods	5
● Typical Characteristics Data/Packaging	7
<b>DHR Series ⚠Caution/Notice</b>	8
<b>2 Mold Type DHS N4700 Series (DC10-40kV)</b>	10
● Typical Characteristics Data / Specifications and Test Methods	12
<b>3 Mold Type DHS Z5V Series (DC20-40kV)</b>	13
● Typical Characteristics Data	14
● Specifications and Test Methods	15
<b>DHS Series ⚠Caution and Notice</b>	16
<b>ISO9000 Certifications</b>	18

2

3

## ● Part Numbering

### High Voltage Ceramic Capacitors (over 10kV)

(Global Part Number) 

DH	R	B3	4A	101	M	2B	B
①	②	③	④	⑤	⑥	⑦	⑧

#### ① Product ID

Product ID	
<b>DH</b>	High Voltage Ceramic Capacitors (over 10kV)

#### ② Series Category

Code	Contents
<b>R</b>	Radial Type
<b>S</b>	Mold Type

First three digits of part number (①Product ID and ②Series Category) express "Series Name".

#### ③ Temperature Characteristics

Code	Temp. Char.	Cap. Change or Temp. Coeff.	Temp. Range
<b>B3</b>	<b>B</b>	±10%	−25 to +85°C
<b>F4</b>	<b>Z5V</b>	+22%, −82%	+10 to +85°C
<b>4E</b>	<b>ZM</b> <b>N4700</b>	−4700±1000ppm/°C	+20 to +85°C

#### ④ Rated Voltage

Code	Rated Voltage
<b>4A</b>	DC10kV
<b>4B</b>	DC12kV
<b>4C</b>	DC15kV
<b>4D</b>	DC20kV
<b>4F</b>	DC30kV
<b>4G</b>	DC40kV

#### ⑤ Capacitance

Expressed by three figures. The unit is pico-farad (pF). The first and second figures are significant digits, and the third figure expresses the number of zeros which follow the two numbers. If there is a decimal point, it is expressed by the capital letter "R". In this case, all figures are significant digits.

#### ⑥ Capacitance Tolerance

Code	Capacitance Tolerance
<b>K</b>	±10%
<b>M</b>	±20%
<b>Z</b>	+80%, −20%

#### ⑦ Lead Type (DHR Series)

Code	Lead Type	Lead Spacing	Lead Diameter
<b>2B</b>	Straight Long	9.5mm	ø0.65mm
<b>2F</b>		12.7mm	ø0.8mm

#### ⑦ Body Diameter and Terminal Type (DHS Series)

Code	Body Diameter	Terminal Type
<b>C2</b>	20mm	ISO M4, P0.7 Tapped Holes (Metric Screw Thread)
<b>D2</b>	24mm	
<b>H2</b>	30mm	
<b>L2</b>	38mm	
<b>N2</b>	43mm	
<b>R2</b>	52mm	
<b>T2</b>	60mm	No.8-32, NC-2B Tapped Holes (Inch Screw Thread)
<b>CX</b>	20mm	
<b>DX</b>	24mm	
<b>HX</b>	30mm	
<b>LX</b>	38mm	
<b>NX</b>	43mm	
<b>RX</b>	52mm	
<b>TX</b>	60mm	

#### ⑧ Packaging

Code	Packaging
<b>B</b>	Bulk

# High Voltage Ceramic Capacitors DC10-40kV



## Radial Lead Type DHR Series (DC10-15kV)

### ■ Features

1. Small size
2. Excellent heat-proof, humidity-proof and high-dielectric strength voltage.
3. Coated with flame-retardant epoxy resin.

### ■ Applications

1. Color TV doublers and triplers
2. High voltage DC power supplies (PPCs, X-ray apparatus, air cleaner, lasers, etc.)
3. Tuning capacitor in focus circuit for display

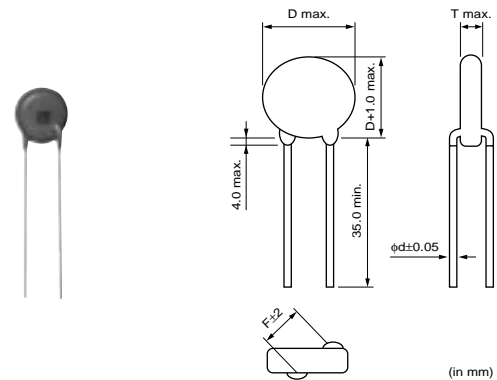

### ■ Marking

		Temp. Char.	ZM	B
Nominal body dia.				
ø8mm			101 10K	101 10K
ø9mm and 10mm			221K 10K•	221M 10K
ø11mm to 14mm			ZM 471K 10K	B 471M 10K
ø15mm to 18mm			102KZ M 10K 0050	102MB M 10K 0050
Temperature Characteristics	Nominal body dia. ø8mm		Omitted	Omitted
	Nominal body dia. ø9 and 10mm		Marked with • (dot)	
	Nominal body dia. ø11 to 14mm		Marked with code.	
	Nominal body dia. ø15mm min.		Marked with Z.	Marked with code.
<b>Nominal Capacitance</b>			Under 100pF : Actual value, 100pF and over : Marked with 3 figures.	
<b>Capacitance Tolerance</b>			Marked with code, omitted for nominal body diameter ø8mm and under.	
<b>Rated Voltage</b>			Marked with code.	
<b>Manufacturer's Identification</b>			Marked with M, omitted for nominal body diameter ø14mm and under.	
<b>Manufactured Date</b>			Abbreviation, omitted for nominal body diameter ø14mm and under. (Ex.) 0050 ① : Last numeral in year ③ : Fix No. ① ② ③ ② : Number in the month	

## ZM Characteristics

Part Number	Rated Voltage (kV)	Capacitance (pF)	Body Dia. D (mm)	Lead Spacing F (mm)	Body Thickness T (mm)	Lead Dia. ød (mm)
DHR4E4A101K2BB	DC10	100 +10, -10%	8.0	9.5	7.0	0.65
DHR4E4A151K2BB	DC10	150 +10, -10%	8.0	9.5	7.0	0.65
DHR4E4A221K2BB	DC10	220 +10, -10%	9.0	9.5	7.0	0.65
DHR4E4A331K2BB	DC10	330 +10, -10%	10.0	9.5	7.0	0.65
DHR4E4A471K2BB	DC10	470 +10, -10%	12.0	9.5	7.0	0.65
DHR4E4A681K2BB	DC10	680 +10, -10%	13.0	9.5	7.0	0.65
DHR4E4A102K2BB	DC10	1000 +10, -10%	15.0	9.5	7.0	0.65
DHR4E4B101K2BB	DC12	100 +10, -10%	8.0	9.5	7.3	0.65
DHR4E4B151K2BB	DC12	150 +10, -10%	9.0	9.5	7.3	0.65
DHR4E4B221K2BB	DC12	220 +10, -10%	9.0	9.5	7.3	0.65
DHR4E4B331K2BB	DC12	330 +10, -10%	11.0	9.5	7.3	0.65
DHR4E4B471K2BB	DC12	470 +10, -10%	12.0	9.5	7.3	0.65
DHR4E4B681K2BB	DC12	680 +10, -10%	14.0	9.5	7.3	0.65
DHR4E4B102K2BB	DC12	1000 +10, -10%	16.0	9.5	7.3	0.65
DHR4E4C101K2BB	DC15	100 +10, -10%	8.0	9.5	8.2	0.65
DHR4E4C151K2BB	DC15	150 +10, -10%	9.0	9.5	8.2	0.65
DHR4E4C221K2BB	DC15	220 +10, -10%	10.0	9.5	8.2	0.65
DHR4E4C331K2BB	DC15	330 +10, -10%	12.0	9.5	8.2	0.65
DHR4E4C471K2BB	DC15	470 +10, -10%	13.0	9.5	8.2	0.65
DHR4E4C681K2BB	DC15	680 +10, -10%	15.0	9.5	8.2	0.65
DHR4E4C102K2FB	DC15	1000 +10, -10%	18.0	12.7	8.2	0.8

## B Characteristics

Part Number	Rated Voltage (kV)	Capacitance (pF)	Body Dia. D (mm)	Lead Spacing F (mm)	Body Thickness T (mm)	Lead Dia. ød (mm)
DHRB34A101M2BB	DC10	100 +20, -20%	8.0	9.5	7.0	0.65
DHRB34A151M2BB	DC10	150 +20, -20%	8.0	9.5	7.0	0.65
DHRB34A221M2BB	DC10	220 +20, -20%	9.0	9.5	7.0	0.65
DHRB34A331M2BB	DC10	330 +20, -20%	10.0	9.5	7.0	0.65
DHRB34A471M2BB	DC10	470 +20, -20%	12.0	9.5	7.0	0.65
DHRB34A681M2BB	DC10	680 +20, -20%	13.0	9.5	7.0	0.65
DHRB34A102M2BB	DC10	1000 +20, -20%	15.0	9.5	7.0	0.65
DHRB34B101M2BB	DC12	100 +20, -20%	8.0	9.5	7.7	0.65
DHRB34B151M2BB	DC12	150 +20, -20%	9.0	9.5	7.5	0.65
DHRB34B221M2BB	DC12	220 +20, -20%	9.0	9.5	7.5	0.65
DHRB34B331M2BB	DC12	330 +20, -20%	11.0	9.5	7.5	0.65
DHRB34B471M2BB	DC12	470 +20, -20%	12.0	9.5	7.5	0.65
DHRB34B681M2BB	DC12	680 +20, -20%	14.0	9.5	7.5	0.65
DHRB34B102M2BB	DC12	1000 +20, -20%	16.0	9.5	7.5	0.65
DHRB34C101M2BB	DC15	100 +20, -20%	8.0	9.5	8.5	0.65
DHRB34C151M2BB	DC15	150 +20, -20%	9.0	9.5	8.2	0.65
DHRB34C221M2BB	DC15	220 +20, -20%	10.0	9.5	8.2	0.65
DHRB34C331M2BB	DC15	330 +20, -20%	12.0	9.5	8.2	0.65
DHRB34C471M2BB	DC15	470 +20, -20%	13.0	9.5	8.2	0.65
DHRB34C681M2BB	DC15	680 +20, -20%	15.0	9.5	8.2	0.65
DHRB34C102M2FB	DC15	1000 +20, -20%	18.0	12.7	8.2	0.8

# Specifications and Test Methods

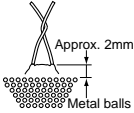
No.	Item	Specifications	Testing Method																		
1	Operating Temperature Range	-25 to +100°C	—																		
2	Capacitance	Within the specified tolerance.	The capacitance should be measured at 20°C with 1±0.2kHz and AC 5V(r.m.s.) max.																		
3	Dissipation Factor (D.F.)	<table border="1" style="margin-left: auto; margin-right: auto;"> <tr> <td>ZM</td> <td>1.0% max.</td> </tr> <tr> <td>B</td> <td>2.5% max.</td> </tr> </table>	ZM	1.0% max.	B	2.5% max.	Same condition as capacitance.														
ZM	1.0% max.																				
B	2.5% max.																				
4	Insulation Resistance (I.R.)	Between Lead Wires 10000MΩ min.	The insulation resistance should be measured with DC1000V within 60±5 sec. of charging.																		
5	Dielectric Strength	Between Lead Wires	No failure. The capacitor should not be damaged when DC voltage of 150% of the rated voltage is applied between the lead wires for 60±5 sec. in insulating liquid or gas. (Charge/Discharge current≤50mA)																		
		Body Insulation	No failure. The capacitor is placed in the container with metal balls of diameter 1mm so that each lead wire, shortcircuited, is kept approximately 2mm off the metal balls as shown in the figure at right, and DC voltage of 3kV is applied for 10 sec. between capacitor lead wires and metal balls. (Charge/Discharge current≤50mA)																		
																					
6	Temperature Characteristics	<table border="1" style="margin-left: auto; margin-right: auto;"> <thead> <tr> <th>Temp. Char.</th> <th>Temp. Coefficient or Max. Cap. Change</th> </tr> </thead> <tbody> <tr> <td>ZM</td> <td>-4700±1000ppm/°C</td> </tr> <tr> <td>B</td> <td>±10%</td> </tr> </tbody> </table>	Temp. Char.	Temp. Coefficient or Max. Cap. Change	ZM	-4700±1000ppm/°C	B	±10%	The capacitance measurement should be made at each step specified in table. Capacitance change from the value of step 3 should not exceed the limit specified.												
Temp. Char.	Temp. Coefficient or Max. Cap. Change																				
ZM	-4700±1000ppm/°C																				
B	±10%																				
		<table border="1" style="margin-left: auto; margin-right: auto;"> <thead> <tr> <th>Step Char.</th> <th>1</th> <th>2</th> <th>3</th> <th>4</th> <th>5</th> </tr> </thead> <tbody> <tr> <td>ZM</td> <td style="text-align: center;">—</td> <td style="text-align: center;">—</td> <td style="text-align: center;">20±2°C</td> <td style="text-align: center;">85±2°C</td> <td style="text-align: center;">20±2°C</td> </tr> <tr> <td>B</td> <td style="text-align: center;">20±2°C</td> <td style="text-align: center;">-25±3°C</td> <td style="text-align: center;">20±2°C</td> <td style="text-align: center;">85±2°C</td> <td style="text-align: center;">20±2°C</td> </tr> </tbody> </table>		Step Char.	1	2	3	4	5	ZM	—	—	20±2°C	85±2°C	20±2°C	B	20±2°C	-25±3°C	20±2°C	85±2°C	20±2°C
Step Char.	1	2	3	4	5																
ZM	—	—	20±2°C	85±2°C	20±2°C																
B	20±2°C	-25±3°C	20±2°C	85±2°C	20±2°C																
7	Soldering Effect	Appearance	No marked defect.																		
		Capacitance Change	Within ±10%																		
		Dielectric Strength (Between Lead Wires)	No failure.																		
		The lead wires should be immersed into the melted solder of 350±10°C up to about 1.5 to 2.0mm from the main body for 3.5±0.5 sec. Post-treatment: Capacitor should be stored for 24±2 hrs. at *room condition.																			
8	Humidity (Under Steady State)	Appearance	No marked defect.																		
		Capacitance Change	Within ±10%																		
		D.F.	<table border="1" style="margin-left: auto; margin-right: auto;"> <tr> <td>ZM</td> <td>1.5% max.</td> </tr> <tr> <td>B</td> <td>4.0% max.</td> </tr> </table>	ZM	1.5% max.	B	4.0% max.														
		ZM	1.5% max.																		
		B	4.0% max.																		
I.R.	5000MΩ min.																				
Dielectric Strength (Between Lead Wires)	No failure.																				
		Set the capacitor for 240±8 hrs. at 40±2°C in 90 to 95% relative humidity. Post-treatment: Capacitor should be stored for 1 to 2 hrs. at *room condition.																			
9	Life	Appearance	No marked defect.																		
		Capacitance Change	Within ±10%																		
		D.F.	<table border="1" style="margin-left: auto; margin-right: auto;"> <tr> <td>ZM</td> <td>1.5% max.</td> </tr> <tr> <td>B</td> <td>4.0% max.</td> </tr> </table>	ZM	1.5% max.	B	4.0% max.														
		ZM	1.5% max.																		
		B	4.0% max.																		
I.R.	5000MΩ min.																				
Dielectric Strength (Between Lead Wires)	No failure																				
		Apply a DC voltage of 125% of the rated voltage for 1000 <sup>+48</sup> <sub>0</sub> hrs. in silicon oil at 85±2°C. Post-treatment: Capacitor should be stored for 24±2 hrs. at *room condition. (Charge/Discharge current≤50mA)																			

(Note) Tests for Dielectric Strength (between lead wires), Charge Discharge Test, Humidity, Temperature Cycle and Life should be performed with specimens having molded resin (MR1023C : made by Murata) extending over 3mm on all the surface.

\* "room condition" Temperature: 15 to 35°C, Relative humidity: 45 to 75%, Atmospheric pressure: 86 to 106kPa

Continued on the following page.

# 1 Specifications and Test Methods

Continued from the preceding page.

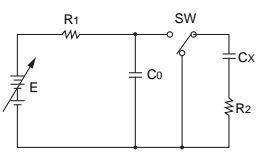
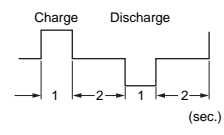
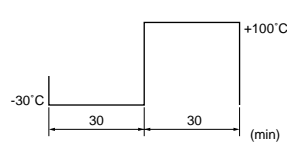
No.	Item	Specifications	Testing Method				
10	Charge Discharge Test	Appearance Capacitance Change D.F. I.R. Dielectric Strength (Between Lead Wires)	<p>Charge discharge test should be measured in the following test circuit and cycle.</p> <p>Applied voltage : Rated voltage Cycle time : 20000 cycle</p> <p>Post-treatment : Capacitor should be stored for 4 hrs. at *room condition.</p> <div style="display: flex; justify-content: space-around;"> <div style="text-align: center;"> <p>&lt;Circuit&gt;</p>  </div> <div style="text-align: center;"> <p>&lt;Cycle&gt;</p>  </div> </div> <p>Cx : specimen R1 : circuit protective resistor (300kΩ) C0 : supplied energy for Cx. C0≧10Cx R2 : current limiting resistor (E/10Ω) E : direct-current voltage source</p>				
	Appearance	No marked defect.					
	Capacitance Change	Within ±10%					
	D.F.	<table border="1" style="margin-left: auto; margin-right: auto;"> <tr> <td>ZM</td> <td>1.5% max.</td> </tr> <tr> <td>B</td> <td>4.0% max.</td> </tr> </table>		ZM	1.5% max.	B	4.0% max.
	ZM	1.5% max.					
B	4.0% max.						
I.R.	5000MΩ min.						
Dielectric Strength (Between Lead Wires)	No failure.						
11	Temperature Cycle	Appearance Capacitance Change D.F. I.R. Dielectric Strength (Between Lead Wires)	<p>Temperature cycle should be measured in the following test.</p> <p>Cycle time : 5 cycle Post-treatment : Capacitor should be stored for 4 hrs. at *room condition.</p> <div style="text-align: center;">  </div>				
	Appearance	No marked defect.					
	Capacitance Change	Within ±10%					
	D.F.	<table border="1" style="margin-left: auto; margin-right: auto;"> <tr> <td>ZM</td> <td>1.5% max.</td> </tr> <tr> <td>B</td> <td>4.0% max.</td> </tr> </table>		ZM	1.5% max.	B	4.0% max.
	ZM	1.5% max.					
B	4.0% max.						
I.R.	5000MΩ min.						
Dielectric Strength (Between Lead Wires)	No failure.						
12	Strength of Lead	Pull	Lead wire should not be cut off. Capacitor should not be broken.				
		Bending	As shown in the figure at right, fix the body of the capacitor and apply a tensile weight gradually to each lead wire in the radial direction of the capacitor up to 10N and keep it for 10±1 sec.				
Solderability of Leads		Lead wire should be soldered with uniform coating on the axial direction over $\frac{3}{4}$ of the circumferential direction.	Each lead wire should be subjected to 5N of weight and bent 90° at the point of egress, in one direction, then returned to its original position and bent 90° in the opposite direction at the rate of one bend in 2 to 3 sec.				

(Note) Tests for Dielectric Strength (between lead wires), Charge Discharge Test, Humidity, Temperature Cycle and Life should be performed with specimens having molded resin (MR1023C : made by Murata) extending over 3mm on all the surface.

\* "room condition" Temperature: 15 to 35°C, Relative humidity: 45 to 75%, Atmospheric pressure: 86 to 106kPa



# Typical Characteristics Data/Packaging

## ■ Cap.-Temp. Char.

ZM Characteristics

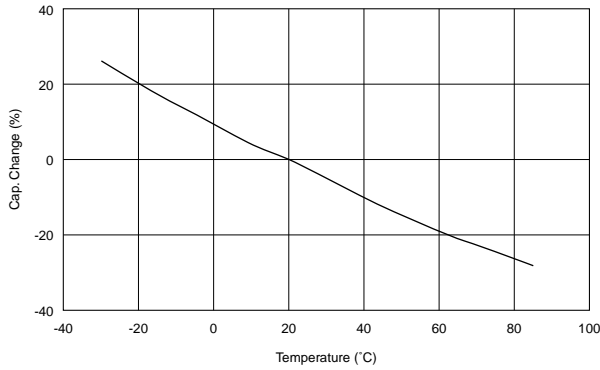

B Characteristics

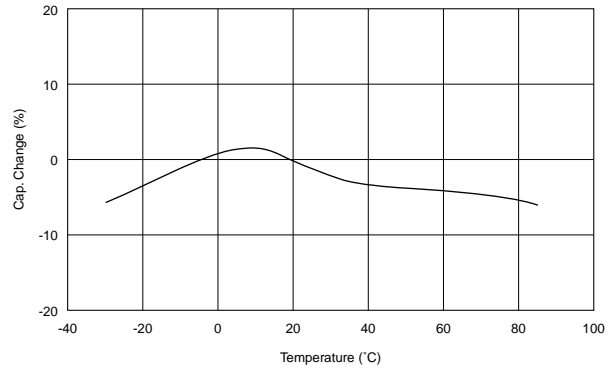

## ■ Cap.-DC Bias Char.

ZM Characteristics

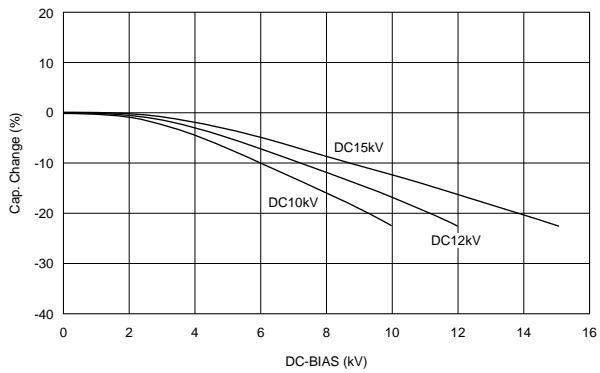

B Characteristics

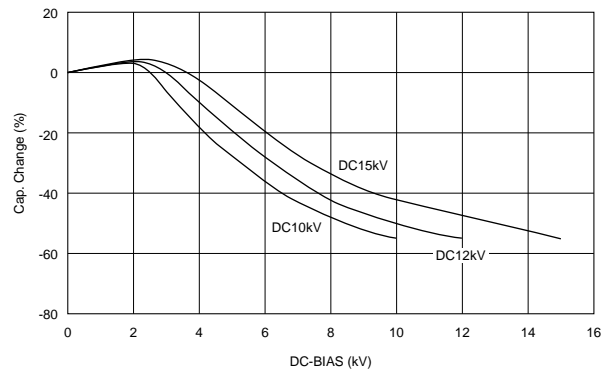

## ■ Packaging Styles



Minimum Quantity (Order in Sets Only)	200 (pcs.)
Minimum Order Quantity	200 (pcs.)

- "Minimum Quantity" means the number of units of each delivery or order. The quantity should be an integral multiple of the "minimum quantity". (Please note that the actual delivery quantity in a package may change sometimes.)

## ■ Example

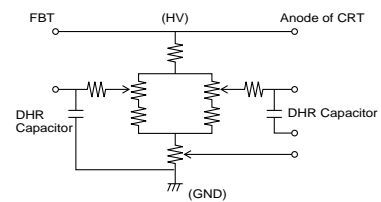

## DHR Series ⚠Caution/Notice

### ■ ⚠Caution (Rating)

#### 1. Operating Voltage

When DC-rated capacitors are to be used in AC or ripple current circuits, be sure to maintain the  $V_{p-p}$  value of the applied voltage or the  $V_{o-p}$  which contains DC bias within the rated voltage range.

When the voltage is applied to the circuit, starting or stopping may generate irregular voltage for a transit period because of resonance or switching. Be sure to use a capacitor with a rated voltage range that includes these irregular voltages.

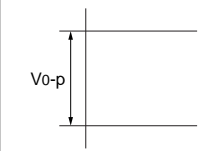
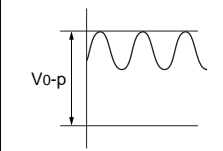
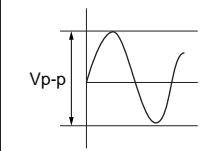
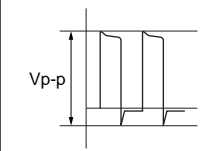
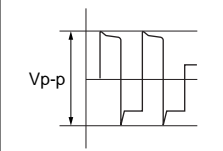
Voltage	DC Voltage	DC+AC Voltage	AC Voltage	Pulse Voltage (1)	Pulse Voltage (2)
Positional Measurement					

#### 2. Operating Temperature and Self-generated Heat

Keep the surface temperature of a capacitor below the upper limit of its rated operating temperature range. Be sure to take into account the heat generated by the capacitor itself. When the capacitor is used in a high-frequency current, pulse current or similar current, it may self-generate heat due to dielectric loss. The applied voltage load should be such that the capacitor's self-generated heat is within  $10^{\circ}\text{C}$  at an atmosphere temperature of  $25^{\circ}\text{C}$ . When measuring, use a thermocouple of small thermal capacity-K of  $\phi 0.1\text{mm}$  in conditions where the capacitor is not affected by radiant heat from other components or surrounding ambient fluctuations. Excessive heat may lead to deterioration of the capacitor's characteristics and reliability. (Never attempt to perform measurement with the cooling fan running. Otherwise, accurate measurement cannot be ensured.)

Failure to follow the above cautions may result, worst case, in a short circuit and cause fuming or partial dispersion when the product is used.

### ■ ⚠Caution (Storage and Operation Condition)

#### Operating and storage environment

The insulating coating of capacitors does not form a perfect seal; therefore, do not use or store capacitors in a corrosive atmosphere, especially where chloride gas, sulfide gas, acid, alkali, salt or the like are present. And avoid exposure to moisture.

The capacitor is designed to be used in insulating media, such as epoxy resin, silicone oil, etc.

There must be 3mm or more of insulating media for each direction of the capacitor.

Before cleaning, bonding, or molding this product,

verify that these processes do not affect product quality by testing the performance of a cleaned, bonded or molded product in the intended equipment. Store the capacitors where the temperature and relative humidity do not exceed  $-10$  to  $40$  degrees centigrade and  $15$  to  $85\%$ . Use capacitors within 6 months.

**FAILURE TO FOLLOW THE ABOVE CAUTIONS MAY RESULT, WORST CASE, IN A SHORT CIRCUIT AND CAUSE FUMING OR PARTIAL DISPERSION WHEN THE PRODUCT IS USED.**

■ ⚠Caution (Soldering and Mounting)

1. Vibration and impact

Do not expose a capacitor or its leads to excessive shock or vibration during use.

2. Soldering

When soldering this product to a PCB/PWB, do not exceed the solder heat resistance specification of the capacitor. Subjecting this product to excessive heating could melt the internal junction solder and may result in thermal shocks that can crack the ceramic element.

When soldering capacitor with a soldering iron, it should be performed in following conditions.

Temperature of iron-tip: 400 degrees C. max.

Soldering iron wattage: 50W max.

Soldering time: 3.5 sec. max.

FAILURE TO FOLLOW THE ABOVE CAUTIONS MAY RESULT, WORST CASE, IN A SHORT CIRCUIT AND CAUSE FUMING OR PARTIAL DISPERSION WHEN THE PRODUCT IS USED.

■ ⚠Caution (Handling)

Vibration and impact

Do not expose a capacitor or its leads to excessive shock or vibration during use.

FAILURE TO FOLLOW THE ABOVE CAUTIONS MAY RESULT, WORST CASE, IN A SHORT CIRCUIT AND CAUSE FUMING OR PARTIAL DISPERSION WHEN THE PRODUCT IS USED.

■ Notice (Soldering and Mounting)

Cleaning (ultrasonic cleaning)

To perform ultrasonic cleaning, observe the following conditions. Rinse bath capacity : Output of 20 watts per liter or less.

Rinsing time : 5 min maximum.

Do not vibrate the PCB/PWB directly.

Excessive ultrasonic cleaning may lead to fatigue destruction of the lead wires.

■ Notice (Rating)

Capacitance change of capacitor

1. Class 1 capacitors

Capacitance might change a little depending on the surrounding temperature or an applied voltage.

Please contact us if you intend to use this product in a strict time constant circuit.

2. Class 2 and 3 capacitors

Class 2 and 3 capacitors with temperature characteristics B, E and F have an aging

characteristic, whereby the capacitor continually decreases its capacitance slightly if the capacitor is left on for a long time. Moreover, capacitance might change greatly depending on the surrounding temperature or an applied voltage. So, it is not likely to be suitable for use in a time constant circuit. Please contact us if you need detailed information.

# High Voltage Ceramic Capacitors DC10-40kV



## Mold Type DHS N4700 Series (DC10-40kV)

2

Murata's high voltage ceramic capacitors, DHS N4700 series, are designed to meet the stringent requirements of high voltage applications.

These capacitors are especially appropriate for applications which require a low dissipation factor and a small voltage coefficient.

### ■ Features

1. Epoxy resin encapsulated
2. Small size
3. Low dissipation factor and low heating value
4. Linear temperature characteristic
5. Low DC, AC-voltage coefficient

### ■ Applications

- Gas laser
- DC HV power supplies
- Lightning arresters, voltage distribution systems
- Electron microscopes, synchroscopes
- Electrostatic coating machines

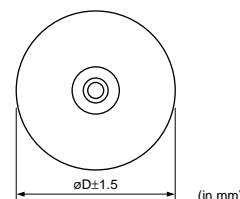
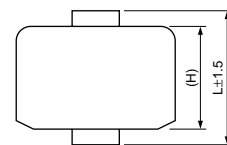

DC Rated Voltage (kV)	Depth of tapped holes (mm)
10, 15	4
20, 30	6
40	8

Part Number	Capacitance (pF)	Capacitance Tolerance (%)	DC Rated Voltage (kV)	Dimensions (mm)			Terminal Type (Screw Thread Type)			
				D	L	H				
DHS4E4A561KC2B	560	±10	10	20	16	12	ISO M4, P0.7 (Metric Screw Thread)			
DHS4E4A122KH2B	1200			30						
DHS4E4A282KL2B	2800			38						
DHS4E4A502KR2B	5000			52						
DHS4E4A802KT2B	8000			60						
DHS4E4A561MCXB	560	±20		10			20	16	12	No.8-32, NC-2B (Inch Screw Thread)
DHS4E4A122MHXB	1200						30			
DHS4E4A282MLXB	2800						38			
DHS4E4A502MRXB	5000						52			
DHS4E4A802MTXB	8000						60			
DHS4E4C371KC2B	370	±10	15		20	18	14			ISO M4, P0.7 (Metric Screw Thread)
DHS4E4C112KH2B	1100				30					
DHS4E4C192KL2B	1900				38					
DHS4E4C342KR2B	3400				52					
DHS4E4C532KT2B	5300				60					
DHS4E4C371MCXB	370	±20		15	20			18	14	No.8-32, NC-2B (Inch Screw Thread)
DHS4E4C112MHXB	1100				30					
DHS4E4C192MLXB	1900				38					
DHS4E4C342MRXB	3400				52					
DHS4E4C532MTXB	5300				60					

Continued on the following page.

Continued from the preceding page.

Part Number	Capacitance (pF)	Capacitance Tolerance (%)	DC Rated Voltage (kV)	Dimensions (mm)			Terminal Type (Screw Thread Type)			
				D	L	H				
DHS4E4D281KC2B	280	±10	20	20	24	20	ISO M4, P0.7 (Metric Screw Thread)			
DHS4E4D881KH2B	880			30						
DHS4E4D142KL2B	1400			38						
DHS4E4D252KR2B	2500			52						
DHS4E4D402KT2B	4000			60						
DHS4E4D281MCXB	280	±20		20				28	24	No.8-32, NC-2B (Inch Screw Thread)
DHS4E4D881MHXB	880			30						
DHS4E4D142MLXB	1400			38						
DHS4E4D252MRXB	2500			52						
DHS4E4D402MTXB	4000			60						
DHS4E4F191KC2B	190	±10	30	20	36	32	ISO M4, P0.7 (Metric Screw Thread)			
DHS4E4F591KH2B	590			30						
DHS4E4F941KL2B	940			38						
DHS4E4F172KR2B	1700			52						
DHS4E4F272KT2B	2700			60						
DHS4E4F191MCXB	190	±20		20				36	32	No.8-32, NC-2B (Inch Screw Thread)
DHS4E4F591MHXB	590			30						
DHS4E4F941MLXB	940			38						
DHS4E4F172MRXB	1700			52						
DHS4E4F272MTXB	2700			60						
DHS4E4G141KC2B	140	±10	40	20	36	32	ISO M4, P0.7 (Metric Screw Thread)			
DHS4E4G441KH2B	440			30						
DHS4E4G701KL2B	700			38						
DHS4E4G132KR2B	1300			52						
DHS4E4G202KT2B	2000			60						
DHS4E4G141MCXB	140	±20		20				36	32	No.8-32, NC-2B (Inch Screw Thread)
DHS4E4G441MHXB	440			30						
DHS4E4G701MLXB	700			38						
DHS4E4G132MRXB	1300			52						
DHS4E4G202MTXB	2000			60						

2

# Typical Characteristics Data / Specifications and Test Methods

## Temperature Characteristic

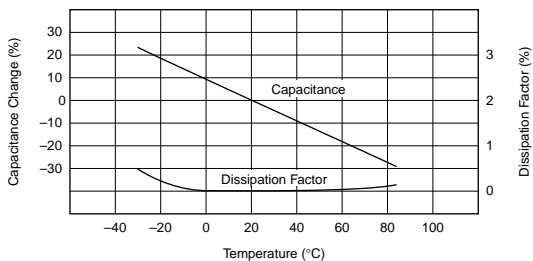

## Typical Voltage Coefficient

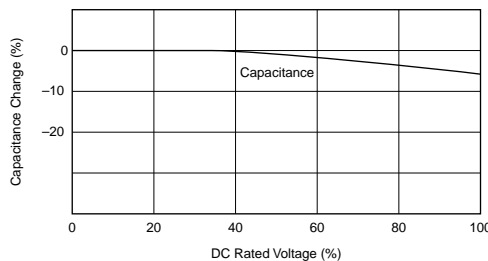

## Frequency Characteristic

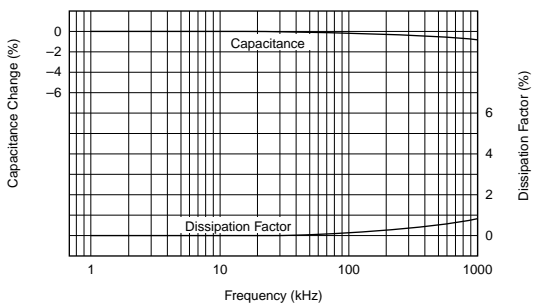

No	Item	Specifications	Testing Method												
1	Operating Temperature Range	-20 to +85°C	—————												
2	Capacitance	Within the specified tolerance.	The capacitance should be measured at 20°C with 1±0.1kHz and AC 1 to 5V(r.m.s.).												
3	Temperature Characteristics	Temperature coefficient -4700±1000ppm/°C (Temp. range: +20 to +85°C)	The capacitance measurement should be made at each step specified in table. Capacitance change from the value of step 3 should not exceed the limit specified. <table border="1"> <thead> <tr> <th>Step</th> <th>1</th> <th>2</th> <th>3</th> <th>4</th> <th>5</th> </tr> </thead> <tbody> <tr> <td>Temp. (°C)</td> <td>—</td> <td>—</td> <td>20±2</td> <td>85±2</td> <td>20±2</td> </tr> </tbody> </table>	Step	1	2	3	4	5	Temp. (°C)	—	—	20±2	85±2	20±2
Step	1	2	3	4	5										
Temp. (°C)	—	—	20±2	85±2	20±2										
4	Dissipation Factor (D.F.)	0.3% max.	The dissipation factor should be measured at 20°C with 1±0.1kHz and AC 1 to 5V(r.m.s.).												
5	Dielectric Strength	Between Terminal	No failure. The capacitor should not be damaged when DC voltage of 150% of the rated voltage is applied between the terminals for 60±5 sec. in insulating liquid or gas. (Charge/Discharge current ≤ 50mA)												
6	Insulation Resistance (I.R.)	1000MΩ min.	The insulation resistance should be measured with DC1000V within 60±5 sec. of charging.												
7	Strength of Terminal	Torque Strength	Capacitor should not be broken. When mounting the capacitor on equipment, be sure to mount them within the torque strength values shown in the table below. <table border="1"> <thead> <tr> <th>Terminal Type</th> <th>torque (N·m)</th> </tr> </thead> <tbody> <tr> <td>ISO M4, No.8-32</td> <td>1.5</td> </tr> </tbody> </table>	Terminal Type	torque (N·m)	ISO M4, No.8-32	1.5								
Terminal Type	torque (N·m)														
ISO M4, No.8-32	1.5														
8	Life	Appearance	No marked defect.												
		Capacitance Change	Within ±5%												
		D.F.	1.0% max.												
		I.R.	1000MΩ min.												
9	Humidity (Under Steady State)	Appearance	No marked defect.												
		Capacitance Change	Within ±5%												
		D.F.	1.0% max.												
		I.R.	1000MΩ min.												

\* "room condition" Temperature: 15 to 35°C, Relative humidity: 45 to 75%, Atmospheric pressure: 86 to 106kPa

# High Voltage Ceramic Capacitors DC10-40kV



## Mold Type DHS Z5V Series (DC20-40kV)

### ■ Features

1. Epoxy resin encapsulated
2. Small size
3. Highly reliable internal construction
4. Wide selection of values
5. Up to DC 40kV working voltage

### ■ Applications

- Electrostatic coating machines
- Electron microscopes, synchroscopes
- CRT power supplies
- Lightning arrester voltage distribution systems
- DC HV power supplies

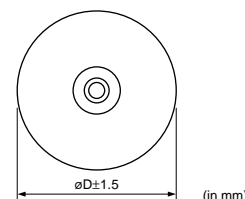
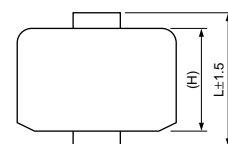

3

Part Number	Capacitance (pF)	Capacitance Tolerance (%)	DC Rated Voltage (kV)	Dimensions (mm)			Terminal Type (Screw Thread Type)	
				D	L	H		
DHSF44D601ZD2B	600	+80, -20	20	24	26	24	ISO M4, P0.7 (Metric Screw Thread)	
DHSF44D102ZH2B	1000			30				
DHSF44D242ZN2B	2400			43				
DHSF44D332ZR2B	3300			52				
DHSF44D482ZT2B	4800			60				
DHSF44D601ZDXB	600			24				
DHSF44D102ZHXB	1000			30				
DHSF44D242ZNXB	2400			43				
DHSF44D332ZRXB	3300			52				
DHSF44D482ZTXB	4800			60				
DHSF44F461ZD2B	460		30	34	32	32	ISO M4, P0.7 (Metric Screw Thread)	
DHSF44F781ZH2B	780							24
DHSF44F182ZN2B	1800							30
DHSF44F252ZR2B	2500							43
DHSF44F362ZT2B	3600							52
DHSF44F461ZDXB	460							60
DHSF44F781ZHXB	780							24
DHSF44F182ZNXB	1800							30
DHSF44F252ZRXB	2500							43
DHSF44F362ZTXB	3600							52
DHSF44G341ZD2B	340	40	41	39	39	ISO M4, P0.7 (Metric Screw Thread)		
DHSF44G571ZH2B	570						24	
DHSF44G132ZN2B	1300						30	
DHSF44G192ZR2B	1900						43	
DHSF44G272ZT2B	2700						52	
DHSF44G341ZDXB	340						60	
DHSF44G571ZHXB	570						24	
DHSF44G132ZNXB	1300						30	
DHSF44G192ZRXB	1900						43	
DHSF44G272ZTXB	2700						52	
							No.8-32, NC-2B (Inch Screw Thread)	

# Typical Characteristics Data

## ■ Dissipation Factor and Capacitance-Temperature

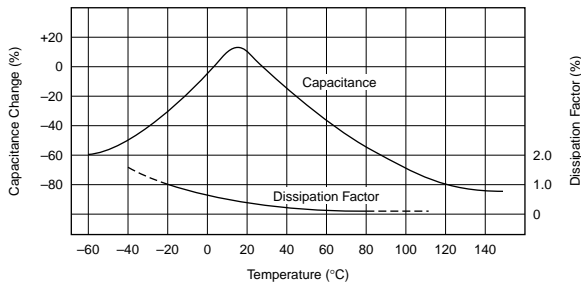

## ■ Life

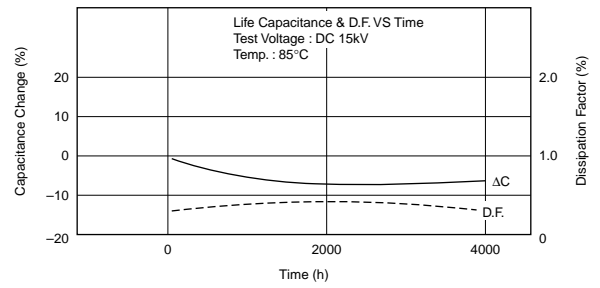

3

## ■ Dissipation Factor and Capacitance-Frequency

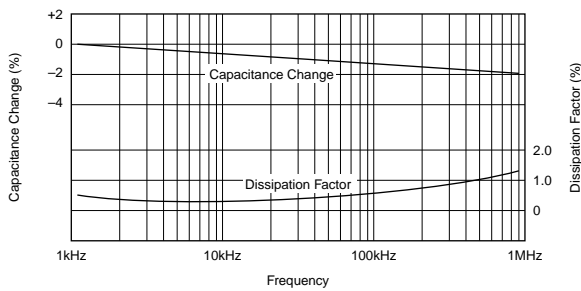

## ■ Humidity

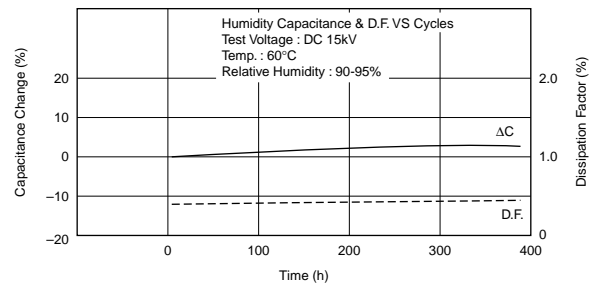

## ■ Typical Voltage Coefficient

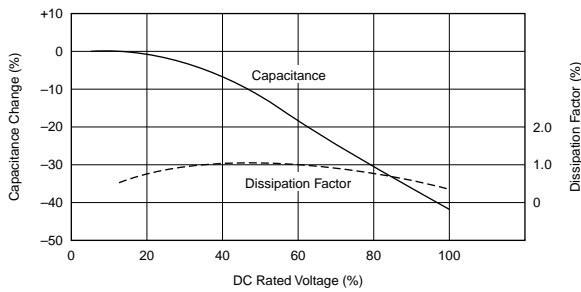



## Specifications and Test Methods

No	Item		Specifications	Testing Method												
1	Operating Temperature Range		-20 to +85°C													
2	Capacitance		Within the specified tolerance.	The capacitance should be measured at 25°C with 1±0.1kHz and AC 1 to 5V (r.m.s.).												
3	Temperature Characteristics		Capacitance change +22%/-82% (Temp. range: +10 to +85°C)	The capacitance measurement should be made at each step specified in table. Capacitance change from the value of step 3 should not exceed the limit specified. <table border="1" style="width: 100%; border-collapse: collapse; text-align: center;"> <thead> <tr> <th>Step</th> <th>1</th> <th>2</th> <th>3</th> <th>4</th> <th>5</th> </tr> </thead> <tbody> <tr> <td>Temp. (°C)</td> <td>25±2</td> <td>-20±3</td> <td>25±2</td> <td>85±2</td> <td>25±2</td> </tr> </tbody> </table>	Step	1	2	3	4	5	Temp. (°C)	25±2	-20±3	25±2	85±2	25±2
Step	1	2	3	4	5											
Temp. (°C)	25±2	-20±3	25±2	85±2	25±2											
4	Dissipation Factor (D.F.)		1.5% max.	The dissipation factor should be measured at 25°C with 1±0.1kHz and AC 1 to 5V (r.m.s.).												
5	Dielectric Strength	Between Terminal	No failure.	The capacitor should not be damaged when DC voltage of 150% of the rated voltage is applied between the terminals for 60±5 sec. in insulating liquid or gas. (Charge/Discharge current ≤ 50mA)												
6	Insulation Resistance (I.R.)		1000MΩ min.	The insulation resistance should be measured with DC1000V within 60±5 sec. of charging.												
7	Strength of Terminal	Torque Strength	Capacitor should not be broken.	When mounting the capacitors on equipment, be sure to mount them within the torque strength values shown in the table below. <table border="1" style="width: 100%; border-collapse: collapse; text-align: center;"> <thead> <tr> <th>Terminal Type</th> <th>torque (N·m)</th> </tr> </thead> <tbody> <tr> <td>ISO M4, No.8-32</td> <td>1.5</td> </tr> </tbody> </table>	Terminal Type	torque (N·m)	ISO M4, No.8-32	1.5								
Terminal Type	torque (N·m)															
ISO M4, No.8-32	1.5															
8	Life	Appearance	No marked defect.	Apply a DC voltage of 125% of the rated voltage for 100+24/-0 hrs. in silicon oil at 85±2°C. Post-treatment: Capacitor should be stored for 24 hrs. at *room condition. (Charge/Discharge current ≤ 50mA)												
		Capacitance Change	Within ±20%													
		D.F.	5.0% max.													
		I.R.	1000MΩ min.													
9	Humidity (Under Steady State)	Appearance	No marked defect.	Set the capacitor for 100+24/-0 hrs. at 40±2°C in 90 to 95% relative humidity. Post-treatment: Capacitor should be stored for 24 hrs. at *room condition.												
		Capacitance Change	Within ±20%													
		D.F.	5.0% max.													
		I.R.	1000MΩ min.													

\* "room condition" Temperature: 15 to 35°C, Relative humidity: 45 to 75%, Atmospheric pressure: 86 to 106kPa

3

## DHS Series ⚠️Caution and Notice

### ⚠️Caution

#### 1. Operating voltage

When DC-rated capacitors are to be used in AC or ripple current circuits, be sure to maintain the  $V_{p-p}$  value of the applied voltage or the  $V_{o-p}$  which contains DC bias within the rated voltage range. When the voltage is applied to the circuit, starting or stopping may generate irregular voltage for a transit period because of resonance or switching. Be sure to use a capacitor with a rated voltage range that includes these irregular voltages.

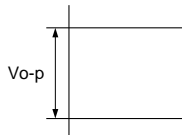
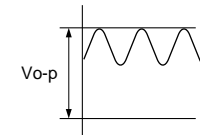
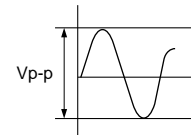
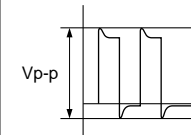
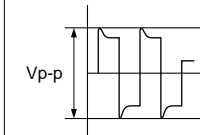
Voltage	DC Voltage	DC+AC Voltage	AC Voltage	Pulse Voltage (1)	Pulse Voltage (2)
Positional Measurement					

#### 2. Operating temperature and self-generated heat

Keep the surface temperature of a capacitor below the upper limit of its rated operating temperature range. Be sure to take into account the heat generated by the capacitor itself.

When the capacitor is used in a high-frequency current, pulse current or similar current, it may self-generate heat due to dielectric loss. The applied voltage load should be such that the capacitor's self-generated heat is within 10°C at an atmosphere temperature of 25°C.

When measuring, use a thermocouple of small thermal capacity-K of  $\varnothing 0.1\text{mm}$  in conditions where the capacitor is not affected by radiant heat from other components or surrounding ambient fluctuations.

Excessive heat may lead to deterioration of the capacitor's characteristics and reliability. (Never attempt to perform measurement with the cooling fan running. Otherwise, accurate measurement cannot be ensured.)

#### 3. Installation

Installation torque should not exceed the torque strength values in "Specifications and Test Methods".

Do not use a screw with a thread depth greater than specified.

Avoid installation in which any bending torque is applied to the capacitor terminal.

Do not rework or resolder the terminal.

#### 4. Operating and storage environment

The insulating coating of capacitors does not form a perfect seal; therefore, do not use or store capacitors in a corrosive atmosphere, especially where chloride gas, sulfide gas, acid, alkali, salt or the like are present. And avoid exposure to moisture.

Before cleaning, bonding, or molding this product, verify that these processes do not affect product quality by testing the performance of a cleaned, bonded or molded product in the intended equipment.

Store the capacitors where the temperature and relative humidity do not exceed  $-10$  to  $40^\circ\text{C}$  and 15 to 85%. Use capacitors within 6 months.

#### 5. Vibration and impact

Do not expose a capacitor to excessive shock or vibration during use.

Failure to follow the above cautions may result, worst case, in a short circuit and cause fuming or partial dispersion when the product is used.

## DHS Series ⚠Caution and Notice

### ■ Notice

#### Capacitance change of capacitor

##### ● Class 1 capacitors

Capacitance might change a little depending on the surrounding temperature or an applied voltage.

Please contact us if you intend to use this product in a strict time constant circuit.

##### ● Class 2 and 3 capacitors

Class 2 and 3 capacitors with temperature characteristics B, E and F have an aging characteristic, whereby the capacitor continually decreases its capacitance slightly if the capacitor is left on for a long time. Moreover, capacitance might change greatly depending on the surrounding temperature or an applied voltage. So, it is not likely to be suitable for use in a time constant circuit.

Please contact us if you need detailed information.

## ISO9000 Certifications

Manufacturing plants which produce the products in this catalog have obtained the ISO9000 quality system certificate.

Plant	Certified Date	Organization	Registration No.	Applied standard
Izumo Murata Manufacturing Co., Ltd.	Feb. 1. '00	Underwriters Laboratories Inc.	A5587	ISO9001
Murata Electronics (Thailand), Ltd.	Apr. 8. '02	Underwriters Laboratories Inc.	A6279	ISO9001

**⚠Note:**

**1. Export Control**

⟨For customers outside Japan⟩

No muRata products should be used or sold, through any channels, for use in the design, development, production, utilization, maintenance or operation of, or otherwise contribution to (1) any weapons (Weapons of Mass Destruction (nuclear, chemical or biological weapons or missiles) or conventional weapons) or (2) goods or systems specially designed or intended for military end-use or utilization by military end-users.

⟨For customers in Japan⟩

For products which are controlled items subject to the "Foreign Exchange and Foreign Trade Law" of Japan, the export license specified by the law is required for export.

**2. Please contact our sales representatives or product engineers before using the products in this catalog for the applications listed below, which require especially high reliability for the prevention of defects which might directly damage a third party's life, body or property, or when one of our products is intended for use in applications other than those specified in this catalog.**

- |                             |  |
|-----------------------------|--|
| ① Aircraft equipment        | ② Aerospace equipment  |
| ③ Undersea equipment        | ④ Power plant equipment  |
| ⑤ Medical equipment         | ⑥ Transportation equipment (vehicles, trains, ships, etc.)   |
| ⑦ Traffic signal equipment  | ⑧ Disaster prevention / crime prevention equipment   |
| ⑨ Data-processing equipment | ⑩ Application of similar complexity and/or reliability requirements to the applications listed above |

**3. Product specifications in this catalog are as of April 2003. They are subject to change or our products in it may be discontinued without advance notice. Please check with our sales representatives or product engineers before ordering. If there are any questions, please contact our sales representatives or product engineers.**

**4. Please read rating and ⚠CAUTION (for storage, operating, rating, soldering, mounting and handling) in this catalog to prevent smoking and/or burning, etc.**

**5. This catalog has only typical specifications because there is no space for detailed specifications. Therefore, please approve our product specifications or transact the approval sheet for product specifications before ordering.**

**6. Please note that unless otherwise specified, we shall assume no responsibility whatsoever for any conflict or dispute that may occur in connection with the effect of our and/or a third party's intellectual property rights and other related rights in consideration of your use of our products and/or information described or contained in our catalogs. In this connection, no representation shall be made to the effect that any third parties are authorized to use the rights mentioned above under licenses without our consent.**

**7. No ozone depleting substances (ODS) under the Montreal Protocol are used in our manufacturing process.**