

阅读申明

- 1.本站收集的数据手册和产品资料都来自互联网，版权归原作者所有。如读者和版权方有任何异议请及时告之，我们将妥善解决。
- 2.本站提供的中文数据手册是英文数据手册的中文翻译，其目的是协助用户阅读，该译文无法自动跟随原稿更新，同时也可能存在翻译上的不当。建议读者以英文原稿为参考以便获得更精准的信息。
- 3.本站提供的产品资料，来自厂商的技术支持或者使用者的心得体会等，其内容可能存在描述上的差异，建议读者做出适当判断。
- 4.如需与我们联系，请发邮件到marketing@iczoom.com，主题请标有“数据手册”字样。

Read Statement

1. The datasheets and other product information on the site are all from network reference or other public materials, and the copyright belongs to the original author and original published source. If readers and copyright owners have any objections, please contact us and we will deal with it in a timely manner.
2. The Chinese datasheets provided on the website is a Chinese translation of the English datasheets. Its purpose is for reader's learning exchange only and do not involve commercial purposes. The translation cannot be automatically updated with the original manuscript, and there may also be improper translations. Readers are advised to use the English manuscript as a reference for more accurate information.
3. All product information provided on the website refer to solutions from manufacturers' technical support or users the contents may have differences in description, and readers are advised to take the original article as the standard.
4. If you have any questions, please contact us at marketing@iczoom.com and mark the subject with "Datasheets" .



MULTILAYER CERAMIC CHIP CAPACITORS



C Series High Q Capacitors

Type: C0603 [EIA CC0201]

Issue date: April 2011

**TDK MLCC
US Catalog**

Version B11

REMINDERS

Please read before using this product

SAFETY REMINDERS



REMINDERS

1. If you intend to use a product listed in this catalog for a purpose that may cause loss of life or other damage, you must contact our company's sales window.
2. We may modify products or discontinue production of a product listed in this catalog without prior notification.
3. We provide "Delivery Specification" that explain precautions for the specifications and safety of each product listed in this catalog. We strongly recommend that you exchange these delivery specifications with customers that use one of these products.
4. If you plan to export a product listed in this catalog, keep in mind that it may be a restricted item according to the "Foreign Exchange and Foreign Trade Control Law". In such cases, it is necessary to acquire export permission in harmony with this law.
5. Any reproduction or transferring of the contents of this catalog is prohibited without prior permission from our company.
6. We are not responsible for problems that occur related to the intellectual property rights or other rights of our company or a third party when you use a product listed in this catalog. We do not grant license of these rights.
7. This catalog only applies to products purchased through our company or one of our company's official agencies. This catalog does not apply to products that are purchased through other third parties.



C Series High Q Capacitors

Type: C0603

Available Through Distribution Only*

Features



- Higher Q factor than standard capacitors
- High stability with respect to time, temperature, frequency, and voltage
- Excellent attenuation
- High self-resonant frequency
- Lower power dissipation/less energy absorption
- Capacitance range of 0.2pF to 15pF
- Available in standard and tight tolerance
- Please contact TDK for Q values

Applications



- High-frequency applications
- PA modules
- Cellular communication, Bluetooth
- Cable/satellite TV
- GPS/satellite radio
- Filter networks/matching networks
- RF amplifiers/Low noise amplifiers
- VCOs, TCXOs, etc.
- DC blocking circuits

Shape & Dimensions

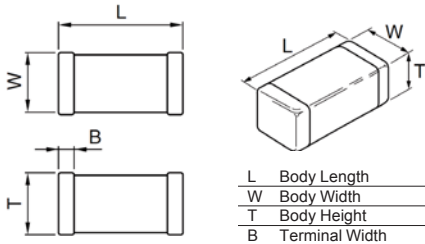

Dimensions in mm



Part Number Construction

Series Name	C	0603	C0G	1E	150	J	T	XXXX	Internal Codes		
Dimensions L x W (mm)									Packaging Style		
Case Code	Length	Width							Packaging Code	Style	
C0603	0.60 ± 0.03	0.30 ± 0.03							T	Tape & Reel	
Temperature Characteristic									Capacitance Tolerance		
Temperature Characteristics	Capacitance Change	Temperature Range							Tolerance Code	Tolerance	
C0G	0±30 ppm/°C	-55 to +125°C							W	± 0.05 pF	
Rated Voltage (DC)									B	± 0.10 pF	
Voltage Code	Voltage (DC)									C	± 0.25 pF
1E	25V									D	± 0.50 pF
Nominal Capacitance (pF)									E	± 0.20 pF	
The capacitance is expressed in three digit codes and in units of pico Farads (pF). The first and second digits identify the first and second significant figures of the capacitance. The third digit identifies the multiplier. R designates a decimal point.											
Capacitance Code	Capacitance									G	± 2%
0R5	0.5pF									J	± 5%
010	1pF										
102	1,000pF (1nF)										
105	1,000,000pF (1µF)										

* This series is available through the distribution channel only. Please see www.tdk.com/distributor.php for a list of authorized distributors.



Capacitance Range Chart

C0603 [EIA CC0201]

Capacitance Range Chart

Temperature Characteristics: C0G (0 ± 30ppm/°C)
 Rated Voltage: 25V(1E)

Capacitance (pF)	Cap Code	Temperature Characteristics	Tolerance							
			W (±0.05)	B (±0.10pF)	C (±0.25pF)	D (±0.50pF)	E (±0.20pF)	G (±2%)	J (±5%)	
0.2	0R2	-55 to 125°C, 0±30 ppm/°C	█	█						
0.3	0R3									
0.4	0R4									
0.5	0R5									
0.6	0R6									
0.7	0R7									
0.8	0R8									
0.9	0R9									
1	010									
1.1	1R1									
1.2	1R2									
1.3	1R3									
1.5	1R5									
1.6	1R6									
1.8	1R8									
2	020									
2.2	2R2									
2.4	2R4									
2.7	2R7									
3	030									
3.3	3R3									
3.6	3R6									
3.9	3R9									
4	040									
4.3	4R3									
4.7	4R7									
5	050									
5.1	5R1									
5.6	5R6									
6	060									
6.2	6R2									
6.8	6R8									
7	070									
7.5	7R5									
8	080									
8.2	8R2									
9	090									
9.1	9R1									
10	100					█	█			
11	110									
12	120									
13	130									
15	150									
16	160									
18	180									
20	200							█	█	

Standard Thickness
 0.30 mm

* This series is available through the distribution channel only. Please see www.tdk.com/distributor.php for a list of authorized distributors.



Capacitance Range Table

C0603 [EIA CC0201]

Class 1 (Temperature Compensating)

Temperature Characteristics: C0G (-55 to 125°C, 0±30 ppm/°C)

TDK Part Number (Ordering Code)	Temperature Characteristics	Rated Voltage	Capacitance (pF)	Capacitance Tolerance	Thickness (mm)
C0603C0G1E0R2WTQ	C0G	25V	0.2	± 0.05pF	0.30 ± 0.03
C0603C0G1E0R2BTQ	C0G	25V	0.2	± 0.10pF	0.30 ± 0.03
C0603C0G1E0R3WTQ	C0G	25V	0.3	± 0.05pF	0.30 ± 0.03
C0603C0G1E0R3BTQ	C0G	25V	0.3	± 0.10pF	0.30 ± 0.03
C0603C0G1E0R4WTQ	C0G	25V	0.4	± 0.05pF	0.30 ± 0.03
C0603C0G1E0R4BTQ	C0G	25V	0.4	± 0.10pF	0.30 ± 0.03
C0603C0G1E0R5WTQ	C0G	25V	0.5	± 0.05pF	0.30 ± 0.03
C0603C0G1E0R5BTQ	C0G	25V	0.5	± 0.10pF	0.30 ± 0.03
C0603C0G1E0R6WTQ	C0G	25V	0.6	± 0.05pF	0.30 ± 0.03
C0603C0G1E0R6BTQ	C0G	25V	0.6	± 0.10pF	0.30 ± 0.03
C0603C0G1E0R7WTQ	C0G	25V	0.7	± 0.05pF	0.30 ± 0.03
C0603C0G1E0R8WTQ	C0G	25V	0.7	± 0.05pF	0.30 ± 0.03
C0603C0G1E0R7BTQ	C0G	25V	0.7	± 0.10pF	0.30 ± 0.03
C0603C0G1E0R8BTQ	C0G	25V	0.8	± 0.10pF	0.30 ± 0.03
C0603C0G1E0R9WTQ	C0G	25V	0.9	± 0.05pF	0.30 ± 0.03
C0603C0G1E0R9BTQ	C0G	25V	0.9	± 0.10pF	0.30 ± 0.03
C0603C0G1E010BTQ	C0G	25V	1.0	± 0.10pF	0.30 ± 0.03
C0603C0G1E010CTQ	C0G	25V	1.0	± 0.25pF	0.30 ± 0.03
C0603C0G1E1R1BTQ	C0G	25V	1.1	± 0.10pF	0.30 ± 0.03
C0603C0G1E1R1CTQ	C0G	25V	1.1	± 0.25pF	0.30 ± 0.03
C0603C0G1E1R2BTQ	C0G	25V	1.2	± 0.10pF	0.30 ± 0.03
C0603C0G1E1R2CTQ	C0G	25V	1.2	± 0.25pF	0.30 ± 0.03
C0603C0G1E1R3BTQ	C0G	25V	1.3	± 0.10pF	0.30 ± 0.03
C0603C0G1E1R3CTQ	C0G	25V	1.3	± 0.25pF	0.30 ± 0.03
C0603C0G1E1R5BTQ	C0G	25V	1.5	± 0.10pF	0.30 ± 0.03
C0603C0G1E1R5CTQ	C0G	25V	1.5	± 0.25pF	0.30 ± 0.03
C0603C0G1E1R6BTQ	C0G	25V	1.6	± 0.10pF	0.30 ± 0.03
C0603C0G1E1R6CTQ	C0G	25V	1.6	± 0.25pF	0.30 ± 0.03
C0603C0G1E1R8BTQ	C0G	25V	1.8	± 0.10pF	0.30 ± 0.03
C0603C0G1E1R8CTQ	C0G	25V	1.8	± 0.25pF	0.30 ± 0.03
C0603C0G1E020BTQ	C0G	25V	2.0	± 0.10pF	0.30 ± 0.03
C0603C0G1E020CTQ	C0G	25V	2.0	± 0.25pF	0.30 ± 0.03
C0603C0G1E2R2BTX	C0G	25V	2.2	± 0.10pF	0.30 ± 0.03
C0603C0G1E2R2CTX	C0G	25V	2.2	± 0.25pF	0.30 ± 0.03
C0603C0G1E2R4BTX	C0G	25V	2.4	± 0.10pF	0.30 ± 0.03
C0603C0G1E2R4CTX	C0G	25V	2.4	± 0.25pF	0.30 ± 0.03
C0603C0G1E2R7BTX	C0G	25V	2.7	± 0.10pF	0.30 ± 0.03
C0603C0G1E2R7CTX	C0G	25V	2.7	± 0.25pF	0.30 ± 0.03
C0603C0G1E030BTX	C0G	25V	3.0	± 0.10pF	0.30 ± 0.03
C0603C0G1E030CTX	C0G	25V	3.0	± 0.25pF	0.30 ± 0.03
C0603C0G1E3R3BTX	C0G	25V	3.3	± 0.10pF	0.30 ± 0.03
C0603C0G1E3R3CTX	C0G	25V	3.3	± 0.25pF	0.30 ± 0.03
C0603C0G1E3R6BTX	C0G	25V	3.6	± 0.10pF	0.30 ± 0.03
C0603C0G1E3R6CTX	C0G	25V	3.6	± 0.25pF	0.30 ± 0.03

* This series is available through the distribution channel only. Please see www.tdk.com/distributor.php for a list of authorized distributors.



Capacitance Range Table

C0603 [EIA CC0201]

Class 1 (Temperature Compensating)

Temperature Characteristics: C0G (-55 to 125°C, 0±30 ppm/°C)

TDK Part Number (Ordering Code)	Temperature Characteristics	Rated Voltage	Capacitance (pF)	Capacitance Tolerance	Thickness (mm)
C0603C0G1E3R9BTX	C0G	25V	3.9	± 0.10pF	0.30 ± 0.03
C0603C0G1E3R9CTX	C0G	25V	3.9	± 0.25pF	0.30 ± 0.03
C0603C0G1E040BTX	C0G	25V	4.0	± 0.10pF	0.30 ± 0.03
C0603C0G1E040CTX	C0G	25V	4.0	± 0.25pF	0.30 ± 0.03
C0603C0G1E4R3BTX	C0G	25V	4.3	± 0.10pF	0.30 ± 0.03
C0603C0G1E4R3CTX	C0G	25V	4.3	± 0.25pF	0.30 ± 0.03
C0603C0G1E4R7BTX	C0G	25V	4.7	± 0.10pF	0.30 ± 0.03
C0603C0G1E4R7CTX	C0G	25V	4.7	± 0.25pF	0.30 ± 0.03
C0603C0G1E050BTX	C0G	25V	5.0	± 0.10pF	0.30 ± 0.03
C0603C0G1E050CTX	C0G	25V	5.0	± 0.25pF	0.30 ± 0.03
C0603C0G1E5R1BTX	C0G	25V	5.1	± 0.10pF	0.30 ± 0.03
C0603C0G1E5R1CTX	C0G	25V	5.1	± 0.25pF	0.30 ± 0.03
C0603C0G1E5R6BTX	C0G	25V	5.6	± 0.10pF	0.30 ± 0.03
C0603C0G1E5R6CTX	C0G	25V	5.6	± 0.25pF	0.30 ± 0.03
C0603C0G1E060BTX	C0G	25V	6.0	± 0.10pF	0.30 ± 0.03
C0603C0G1E060CTX	C0G	25V	6.0	± 0.25pF	0.30 ± 0.03
C0603C0G1E6R2BTX	C0G	25V	6.2	± 0.10pF	0.30 ± 0.03
C0603C0G1E6R2CTX	C0G	25V	6.2	± 0.25pF	0.30 ± 0.03
C0603C0G1E6R8BTX	C0G	25V	6.8	± 0.10pF	0.30 ± 0.03
C0603C0G1E6R8CTX	C0G	25V	6.8	± 0.25pF	0.30 ± 0.03
C0603C0G1E070BTX	C0G	25V	7.0	± 0.10pF	0.30 ± 0.03
C0603C0G1E070CTX	C0G	25V	7.0	± 0.25pF	0.30 ± 0.03
C0603C0G1E7R5BTX	C0G	25V	7.5	± 0.10pF	0.30 ± 0.03
C0603C0G1E7R5CTX	C0G	25V	7.5	± 0.25pF	0.30 ± 0.03
C0603C0G1E080BTX	C0G	25V	8.0	± 0.10pF	0.30 ± 0.03
C0603C0G1E080CTX	C0G	25V	8.0	± 0.25pF	0.30 ± 0.03
C0603C0G1E8R2BTX	C0G	25V	8.2	± 0.10pF	0.30 ± 0.03
C0603C0G1E8R2CTX	C0G	25V	8.2	± 0.25pF	0.30 ± 0.03
C0603C0G1E090BTX	C0G	25V	9.0	± 0.10pF	0.30 ± 0.03
C0603C0G1E090CTX	C0G	25V	9.0	± 0.25pF	0.30 ± 0.03
C0603C0G1E9R1BTX	C0G	25V	9.1	± 0.10pF	0.30 ± 0.03
C0603C0G1E9R1CTX	C0G	25V	9.1	± 0.25pF	0.30 ± 0.03
C0603C0G1E100ETX	C0G	25V	10	± 0.20pF	0.30 ± 0.03
C0603C0G1E100DTX	C0G	25V	10	± 0.50pF	0.30 ± 0.03
C0603C0G1E110GTX	C0G	25V	11	± 2%	0.30 ± 0.03
C0603C0G1E110JTX	C0G	25V	11	± 5%	0.30 ± 0.03
C0603C0G1E120GTX	C0G	25V	12	± 2%	0.30 ± 0.03
C0603C0G1E120JTX	C0G	25V	12	± 5%	0.30 ± 0.03
C0603C0G1E130GTX	C0G	25V	13	± 2%	0.30 ± 0.03
C0603C0G1E130JTX	C0G	25V	13	± 5%	0.30 ± 0.03
C0603C0G1E150GTX	C0G	25V	15	± 2%	0.30 ± 0.03
C0603C0G1E150JTX	C0G	25V	15	± 5%	0.30 ± 0.03
C0603C0G1E160GTX	C0G	25V	16	± 2%	0.30 ± 0.03
C0603C0G1E160JTX	C0G	25V	16	± 5%	0.30 ± 0.03

* This series is available through the distribution channel only. Please see www.tdk.com/distributor.php for a list of authorized distributors.



Capacitance
Range Table

C0603 [EIA CC0201]

Class 1 (Temperature Compensating)

Temperature Characteristics: C0G (-55 to 125°C, 0±30 ppm/°C)

TDK Part Number (Ordering Code)	Temperature Characteristics	Rated Voltage	Capacitance (pF)	Capacitance Tolerance	Thickness (mm)
C0603C0G1E180GTX	C0G	25V	18	± 2%	0.30 ± 0.03
C0603C0G1E180JTX	C0G	25V	18	± 5%	0.30 ± 0.03
C0603C0G1E200GTX	C0G	25V	20	± 2%	0.30 ± 0.03
C0603C0G1E200JTX	C0G	25V	20	± 5%	0.30 ± 0.03

* This series is available through the distribution channel only. Please see www.tdk.com/distributor.php for a list of authorized distributors.



General Specifications

C0603 Series – High Q Capacitors

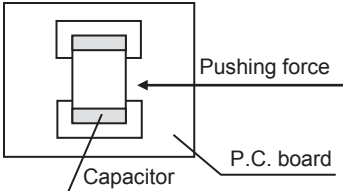
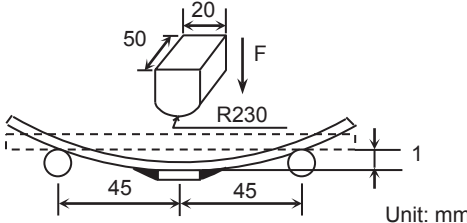
No.	Item	Performance	Test or Inspection Method						
1	External Appearance	No defects which may affect performance.	Inspect with magnifying glass (10×).						
2	Insulation Resistance	10,000MΩ min.	Apply rated voltage for 60s.						
3	Voltage Proof	Withstand test voltage without insulation breakdown or other damage.	<table border="1"> <thead> <tr> <th>Class</th> <th>Apply voltage</th> </tr> </thead> <tbody> <tr> <td>Class 1</td> <td>3 × rated voltage</td> </tr> </tbody> </table> <p>Above DC voltage shall be applied for 1 to 5s. Charge / discharge current shall not exceed 50mA.</p>	Class	Apply voltage	Class 1	3 × rated voltage		
Class	Apply voltage								
Class 1	3 × rated voltage								
4	Capacitance	Within the specified tolerance.	<table border="1"> <thead> <tr> <th>Class</th> <th>Measuring Frequency</th> <th>Measuring voltage</th> </tr> </thead> <tbody> <tr> <td>Class 1</td> <td>1MHz±10%</td> <td>0.5 - 5 V_{rms}</td> </tr> </tbody> </table>	Class	Measuring Frequency	Measuring voltage	Class 1	1MHz±10%	0.5 - 5 V _{rms}
Class	Measuring Frequency	Measuring voltage							
Class 1	1MHz±10%	0.5 - 5 V _{rms}							
5	Q (Class 1)	<table border="1"> <thead> <tr> <th>Rated Capacitance</th> <th>Q</th> </tr> </thead> <tbody> <tr> <td>C ≥ 30pF</td> <td>1,000 min.</td> </tr> <tr> <td>C < 30pF</td> <td>400 + 20 × C min.</td> </tr> </tbody> </table> <p>C : Rated capacitance (pF)</p>	Rated Capacitance	Q	C ≥ 30pF	1,000 min.	C < 30pF	400 + 20 × C min.	See No.4 in this table for measuring condition.
Rated Capacitance	Q								
C ≥ 30pF	1,000 min.								
C < 30pF	400 + 20 × C min.								
6	Temperature Characteristics of Capacitance (Class 1)	<table border="1"> <thead> <tr> <th>T.C.</th> <th>Temperature Coefficient</th> </tr> </thead> <tbody> <tr> <td>COG</td> <td>0 ± 30 ppm/°C</td> </tr> </tbody> </table> <p>Capacitance drift Within ± 0.2% or ±0.05pF, whichever larger.</p>	T.C.	Temperature Coefficient	COG	0 ± 30 ppm/°C	<p>Temperature coefficient shall be calculated based on values at 25°C and 85°C temperature.</p> <p>Measuring temperature below 20°C shall be -10°C and -25°C.</p>		
T.C.	Temperature Coefficient								
COG	0 ± 30 ppm/°C								
7	Robustness of Terminations	No sign of termination coming off, breakage of ceramic, or other abnormal signs.	<p>Reflow solder the capacitor on P.C. board (shown in Appendix 1) and apply a pushing force of 2N for 10 ± 1s.</p> 						
8	Bending	No mechanical damage.	<p>Reflow solder the capacitor on P.C. board (shown in Appendix 2) and bend it for 1mm.</p>  <p>Unit: mm</p>						

* This series is available through the distribution channel only. Please see www.tdk.com/distributor.php for a list of authorized distributors.



No.	Item	Performance	Test or Inspection Method						
9	Solderability	<p>New solder to cover over 75% of termination.</p> <p>25% may have pinholes or rough spots but not concentrated in one spot.</p> <p>Ceramic surface of A sections shall not be exposed due to melting or shifting of termination material.</p>	<p>Completely soak both terminations in solder at $235 \pm 5^\circ\text{C}$ for $2 \pm 0.5\text{s}$.</p> <p>Solder: H63A (JIS Z 3282)</p> <p>Flux: Isopropyl alcohol (JIS K 8839) Rosin (JIS K 5902) 25% solid solution.</p>						
10	Resistance to solder heat		<p>Completely soak both terminations in solder at $260 \pm 5^\circ\text{C}$ for $5 \pm 1\text{s}$.</p> <p>Preheating condition Temp.: $150 \pm 10^\circ\text{C}$ Time : 1 to 2min.</p> <p>Flux: Isopropyl alcohol (JIS K 8839) Rosin (JIS K 5902) 25% solid solution.</p> <p>Solder: H63A (JIS Z 3282)</p>						
	External appearance	No cracks are allowed and terminations shall be covered at least 60% with new solder.							
	Capacitance	<table border="1"> <thead> <tr> <th colspan="2">Characteristics</th> <th>Change from the value before test</th> </tr> </thead> <tbody> <tr> <td>Class 1</td> <td>C0G</td> <td>Capacitance drift within $\pm 2.5\%$ or $\pm 0.25\text{pF}$, whichever larger.</td> </tr> </tbody> </table>	Characteristics		Change from the value before test	Class 1	C0G	Capacitance drift within $\pm 2.5\%$ or $\pm 0.25\text{pF}$, whichever larger.	
Characteristics		Change from the value before test							
Class 1	C0G	Capacitance drift within $\pm 2.5\%$ or $\pm 0.25\text{pF}$, whichever larger.							
	Q (Class 1)	<table border="1"> <thead> <tr> <th>Rated Capacitance</th> <th>Q</th> </tr> </thead> <tbody> <tr> <td>$C \geq 30\text{pF}$</td> <td>1,000 min.</td> </tr> <tr> <td>$C < 30\text{pF}$</td> <td>$400 + 20 \times C$ min.</td> </tr> </tbody> </table> <p style="text-align: center;">C : Rated capacitance (pF)</p>	Rated Capacitance	Q	$C \geq 30\text{pF}$	1,000 min.	$C < 30\text{pF}$	$400 + 20 \times C$ min.	<p>Leave the capacitor in ambient conditions for 6 to 24h before measurement.</p>
Rated Capacitance	Q								
$C \geq 30\text{pF}$	1,000 min.								
$C < 30\text{pF}$	$400 + 20 \times C$ min.								
	Insulation Resistance	Meet the initial spec.							
	Voltage Proof	No insulation breakdown or other damage.							
11	Vibration		<p>Reflow solder the capacitor on P.C. board (shown in Appendix 1) before testing.</p> <p>Vibrate the capacitor with amplitude of 1.5mm P-P sweeping the frequencies from 10Hz to 55Hz and back to 10Hz after 1min.</p> <p>Repeat this for 2h each in 3 perpendicular directions.</p>						
	External appearance	No mechanical damage.							
	Capacitance	<table border="1"> <thead> <tr> <th colspan="2">Characteristics</th> <th>Change from the value before test</th> </tr> </thead> <tbody> <tr> <td>Class 1</td> <td>C0G</td> <td>Capacitance drift within $\pm 2.5\%$ or $\pm 0.25\text{pF}$, whichever larger.</td> </tr> </tbody> </table>	Characteristics		Change from the value before test	Class 1	C0G	Capacitance drift within $\pm 2.5\%$ or $\pm 0.25\text{pF}$, whichever larger.	
Characteristics		Change from the value before test							
Class 1	C0G	Capacitance drift within $\pm 2.5\%$ or $\pm 0.25\text{pF}$, whichever larger.							
	Q (Class 1)	<table border="1"> <thead> <tr> <th>Rated Capacitance</th> <th>Q</th> </tr> </thead> <tbody> <tr> <td>$C \geq 30\text{pF}$</td> <td>1,000 min.</td> </tr> <tr> <td>$C < 30\text{pF}$</td> <td>$400 + 20 \times C$ min.</td> </tr> </tbody> </table> <p style="text-align: center;">C : Rated capacitance (pF)</p>	Rated Capacitance	Q	$C \geq 30\text{pF}$	1,000 min.	$C < 30\text{pF}$	$400 + 20 \times C$ min.	
Rated Capacitance	Q								
$C \geq 30\text{pF}$	1,000 min.								
$C < 30\text{pF}$	$400 + 20 \times C$ min.								

* This series is available through the distribution channel only. Please see www.tdk.com/distributor.php for a list of authorized distributors.



No.	Item	Performance	Test or Inspection Method							
12	Temperature cycle		Reflow solder the capacitors on a P.C. board (shown in Appendix 1) before testing. Expose the capacitor in the conditions in step 1 through step 4, and repeat 5 times consecutively. Leave the capacitor in ambient conditions for 6 to 24h before measurement.							
	External appearance	No mechanical damage.								
	Capacitance	<table border="1"> <thead> <tr> <th colspan="2">Characteristics</th> <th>Change from the value before test</th> </tr> </thead> <tbody> <tr> <td>Class 1</td> <td>C0G</td> <td>Capacitance drift within $\pm 2.5\%$ or $\pm 0.25\text{pF}$, whichever larger.</td> </tr> </tbody> </table>		Characteristics		Change from the value before test	Class 1	C0G	Capacitance drift within $\pm 2.5\%$ or $\pm 0.25\text{pF}$, whichever larger.	
		Characteristics		Change from the value before test						
	Class 1	C0G		Capacitance drift within $\pm 2.5\%$ or $\pm 0.25\text{pF}$, whichever larger.						
	Q (Class 1)	<table border="1"> <thead> <tr> <th>Rated Capacitance</th> <th>Q</th> </tr> </thead> <tbody> <tr> <td>$C \geq 30\text{pF}$</td> <td>1,000 min.</td> </tr> <tr> <td>$C < 30\text{pF}$</td> <td>$400 + 20 \times C$ min.</td> </tr> </tbody> </table> <p style="text-align: center;">C : Rated capacitance (pF)</p>		Rated Capacitance	Q	$C \geq 30\text{pF}$	1,000 min.	$C < 30\text{pF}$	$400 + 20 \times C$ min.	
Rated Capacitance	Q									
$C \geq 30\text{pF}$	1,000 min.									
$C < 30\text{pF}$	$400 + 20 \times C$ min.									
Insulation Resistance	Meet the initial spec.									
Voltage Proof	No insulation breakdown or other damage.									
13	Moisture Resistance (Steady State)		Reflow solder the capacitor on P.C. board (shown in Appendix 1) before testing. Leave at temperature $40 \pm 2^\circ\text{C}$, 90 to 95%RH for 500 +24,0h. Leave the capacitor in ambient condition for 6 to 24h before measurement.							
	External appearance	No mechanical damage.								
	Capacitance	<table border="1"> <thead> <tr> <th colspan="2">Characteristics</th> <th>Change from the value before test</th> </tr> </thead> <tbody> <tr> <td>Class 1</td> <td>C0G</td> <td>Capacitance drift within $\pm 5\%$ or $\pm 0.5\text{pF}$, whichever larger.</td> </tr> </tbody> </table>		Characteristics		Change from the value before test	Class 1	C0G	Capacitance drift within $\pm 5\%$ or $\pm 0.5\text{pF}$, whichever larger.	
		Characteristics		Change from the value before test						
	Class 1	C0G		Capacitance drift within $\pm 5\%$ or $\pm 0.5\text{pF}$, whichever larger.						
	Q (Class 1)	<table border="1"> <thead> <tr> <th>Rated Capacitance</th> <th>Q</th> </tr> </thead> <tbody> <tr> <td>$C \geq 30\text{pF}$</td> <td>350 min.</td> </tr> <tr> <td>$10\text{pF} \leq C < 30\text{pF}$</td> <td>$275 + 5/2 \times C$ min.</td> </tr> <tr> <td>$C < 10\text{pF}$</td> <td>$200 + 10 \times C$ min.</td> </tr> </tbody> </table> <p style="text-align: center;">C : Rated capacitance (pF)</p>		Rated Capacitance	Q	$C \geq 30\text{pF}$	350 min.	$10\text{pF} \leq C < 30\text{pF}$	$275 + 5/2 \times C$ min.	$C < 10\text{pF}$
Rated Capacitance	Q									
$C \geq 30\text{pF}$	350 min.									
$10\text{pF} \leq C < 30\text{pF}$	$275 + 5/2 \times C$ min.									
$C < 10\text{pF}$	$200 + 10 \times C$ min.									
Insulation Resistance	1,000M Ω min.									

* This series is available through the distribution channel only. Please see www.tdk.com/distributor.php for a list of authorized distributors.



No.	Item	Performance	Test or Inspection Method							
14	Moisture Resistance									
	External appearance	No mechanical damage.	Reflow solder the capacitors on P.C. board (shown in Appendix 1) before testing.							
	Capacitance	<table border="1"> <thead> <tr> <th colspan="2">Characteristics</th> <th>Change from the value before test</th> </tr> </thead> <tbody> <tr> <td>Class 1</td> <td>C0G</td> <td>Capacitance drift within $\pm 7.5\%$ or $\pm 0.75\text{pF}$, whichever larger.</td> </tr> </tbody> </table>		Characteristics		Change from the value before test	Class 1	C0G	Capacitance drift within $\pm 7.5\%$ or $\pm 0.75\text{pF}$, whichever larger.	Apply the rated voltage at temperature $40 \pm 2^\circ\text{C}$ and 90 to 95%RH for 500 +24,0h.
		Characteristics		Change from the value before test						
		Class 1	C0G	Capacitance drift within $\pm 7.5\%$ or $\pm 0.75\text{pF}$, whichever larger.						
<table border="1"> <thead> <tr> <th>Rated Capacitance</th> <th>Q</th> </tr> </thead> <tbody> <tr> <td>$C \geq 30\text{pF}$</td> <td>200 min.</td> </tr> <tr> <td>$C < 30\text{pF}$</td> <td>$100 + 10/3 \times C$ min.</td> </tr> </tbody> </table>		Rated Capacitance	Q	$C \geq 30\text{pF}$	200 min.	$C < 30\text{pF}$	$100 + 10/3 \times C$ min.	Charge/discharge current shall not exceed 50mA.		
Rated Capacitance	Q									
$C \geq 30\text{pF}$	200 min.									
$C < 30\text{pF}$	$100 + 10/3 \times C$ min.									
C : Rated capacitance (pF)		Leave the capacitor in ambient conditions for 6 to 24h before measurement.								
Q (Class 1)		Use this measurement for initial value.								
	Insulation Resistance	500M Ω min.								
15	Life									
	External appearance	No mechanical damage.	Reflow solder the capacitor on P.C. board (shown in Appendix 1) before testing.							
	Capacitance	<table border="1"> <thead> <tr> <th colspan="2">Characteristics</th> <th>Change from the value before test</th> </tr> </thead> <tbody> <tr> <td>Class 1</td> <td>C0G</td> <td>Capacitance drift within $\pm 3\%$ or $\pm 0.3\text{pF}$, whichever larger.</td> </tr> </tbody> </table>		Characteristics		Change from the value before test	Class 1	C0G	Capacitance drift within $\pm 3\%$ or $\pm 0.3\text{pF}$, whichever larger.	Apply 2x rated voltage at $125 \pm 2^\circ\text{C}$ for 1,000 +48, 0h.
		Characteristics		Change from the value before test						
		Class 1	C0G	Capacitance drift within $\pm 3\%$ or $\pm 0.3\text{pF}$, whichever larger.						
<table border="1"> <thead> <tr> <th>Rated Capacitance</th> <th>Q</th> </tr> </thead> <tbody> <tr> <td>$C \geq 30\text{pF}$</td> <td>350 min.</td> </tr> <tr> <td>$10\text{pF} \leq C < 30\text{pF}$</td> <td>$275 + 5/2 \times C$ min.</td> </tr> <tr> <td>$C < 10\text{pF}$</td> <td>$200 + 10 \times C$ min.</td> </tr> </tbody> </table>		Rated Capacitance	Q	$C \geq 30\text{pF}$	350 min.	$10\text{pF} \leq C < 30\text{pF}$	$275 + 5/2 \times C$ min.	$C < 10\text{pF}$	$200 + 10 \times C$ min.	Charge/discharge current shall not exceed 50mA.
Rated Capacitance	Q									
$C \geq 30\text{pF}$	350 min.									
$10\text{pF} \leq C < 30\text{pF}$	$275 + 5/2 \times C$ min.									
$C < 10\text{pF}$	$200 + 10 \times C$ min.									
C : Rated capacitance (pF)		Leave the capacitors in ambient condition for 6 to 24h before measurement.								
Q (Class 1)		Use this measurement for initial value.								
	Insulation Resistance	1,000M Ω min.								

* This series is available through the distribution channel only. Please see www.tdk.com/distributor.php for a list of authorized distributors.



C0603 Series – High Q Capacitors

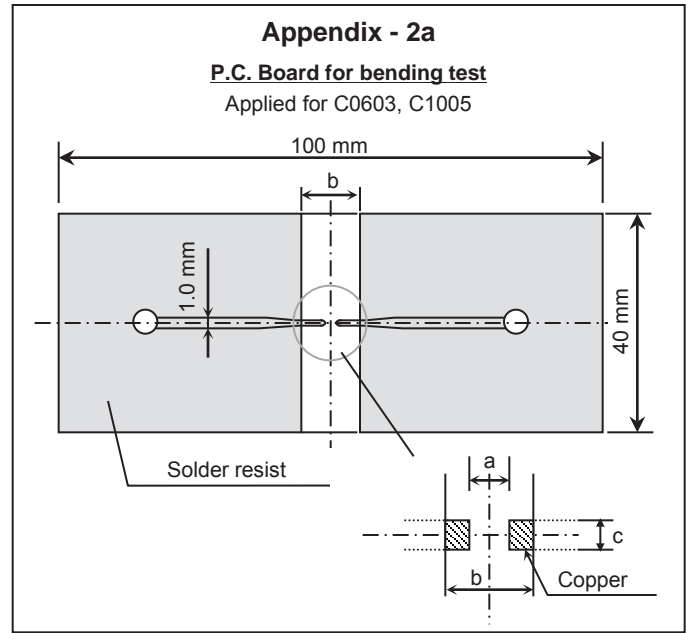
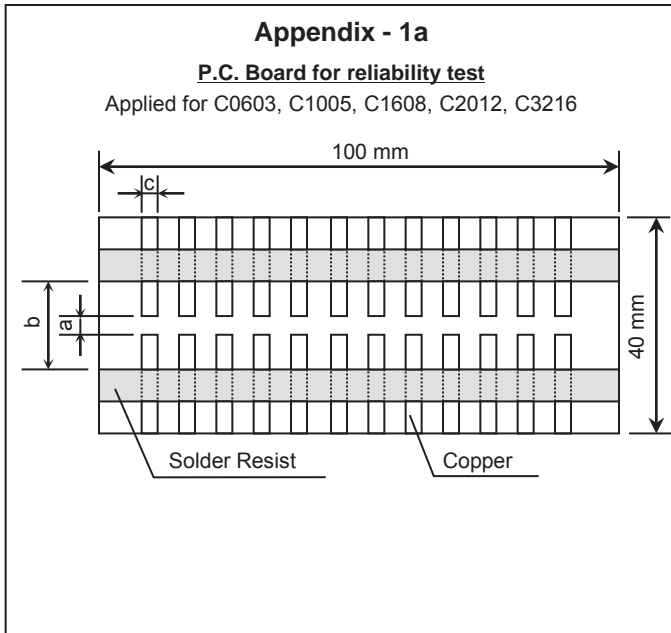

Material : Glass Epoxy (As per JIS C6484 GE4)

P.C. Board thickness : Appendix - 2 0.8mm
Appendix - 1 1.6mm

Case Code		Dimensions (mm)		
JIS	EIA	a	b	c
C0603	CC0201	0.3	0.8	0.3

- Copper (thickness 0.035mm)
- Solder resist

* This series is available through the distribution channel only. Please see www.tdk.com/distributor.php for a list of authorized distributors.

Soldering Information

C0603 Series – High Q Capacitors

Recommended Soldering Land Pattern

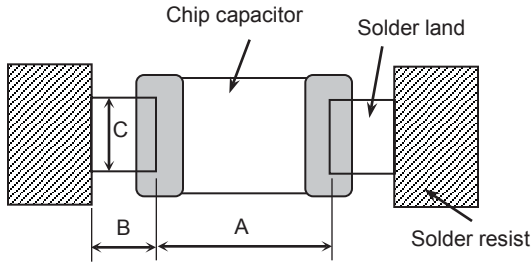

Reflow Soldering		Unit: mm
Type	C0603	
Symbol	[CC0201]	
A	0.25 ~ 0.35	
B	0.2 ~ 0.3	
C	0.25 ~ 0.35	

Recommended Solder Amount

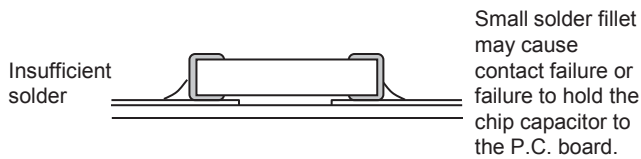
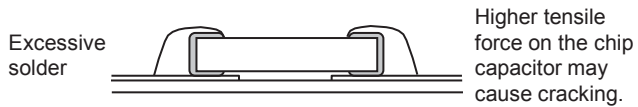

Recommended Soldering Profile

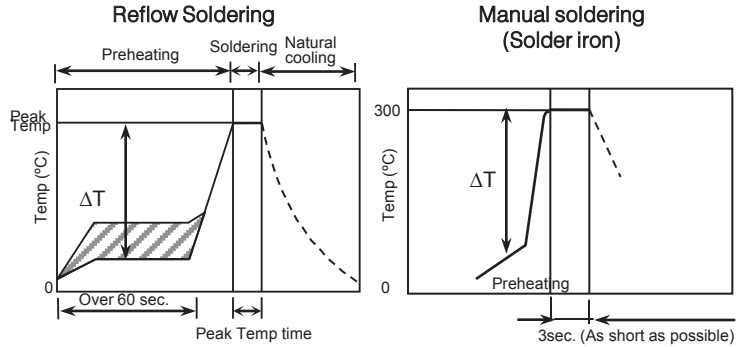

Recommended soldering duration

Solder	Temp./Dura.	Reflow Soldering	
		Peak temp (°C)	Duration (sec.)
Sn-Pb Solder		230 max.	20 max.
Lead-Free Solder		260 max.	10 max.

Recommended solder compositions
 Sn-37Pb (Sn-Pb solder)
 Sn-3.0Ag-0.5Cu (Lead Free Solder)

Preheating Condition

Soldering	Temp. (°C)
Reflow soldering	$\Delta T \leq 150$
Manual soldering	$\Delta T \leq 150$

* This series is available through the distribution channel only. Please see www.tdk.com/distributor.php for a list of authorized distributors.



Packaging Information

C0603 Series – High Q Capacitors

Carrier Tape Configuration

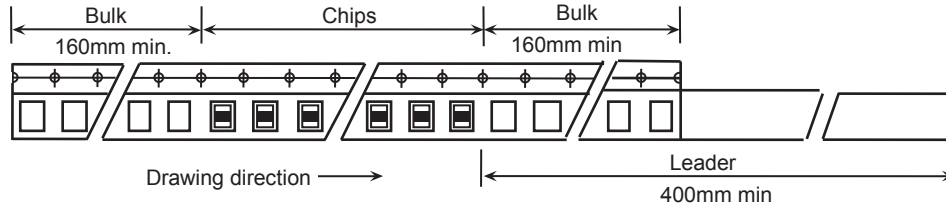

Peel Back Force (Top Tape)

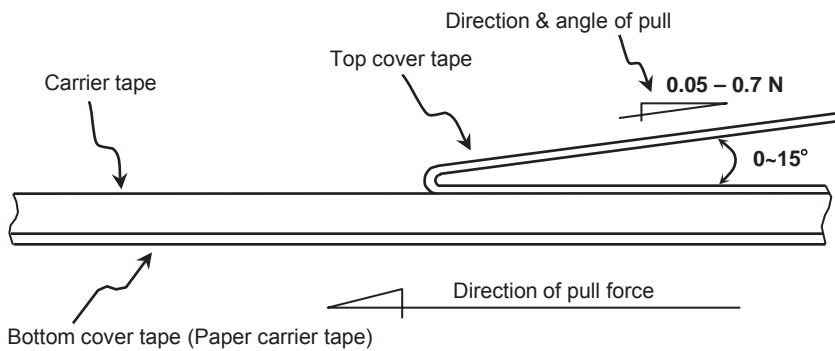

- Carrier tape shall be flexible enough to be wound around a minimum radius of 30mm with components in tape.
- The missing of components shall be less than 0.1%
- Components shall not stick to the cover tape.
- The cover tape shall not protrude beyond the edges of the carrier tape and shall not cover the sprocket holes.

Chip Quantity Per Reel and Structure of Reel

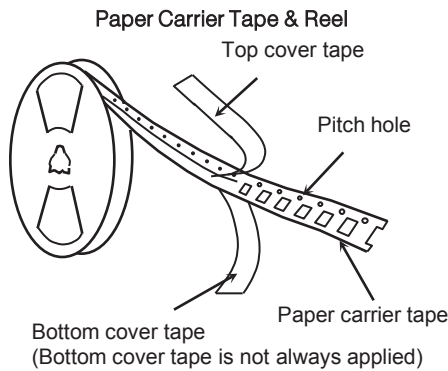

Case Code		Chip Thickness (mm)	Taping Material	Chip quantity (pcs.)
JIS	EIA			φ178mm (7") reel
C0603	CC0201	0.30	Paper	15,000

* This series is available through the distribution channel only. Please see www.tdk.com/distributor.php for a list of authorized distributors.



Additional Information

C0603 Series – High Q Capacitors

• Shape & Dimensions

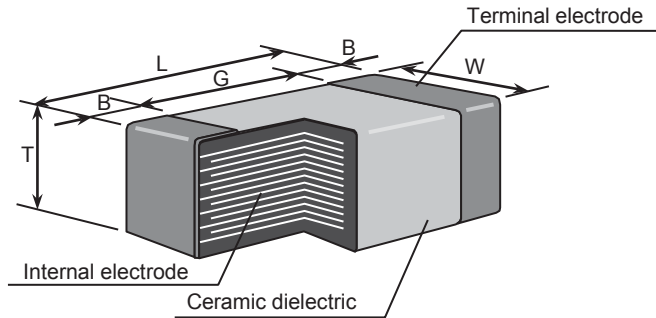

Case Code		Dimensions (mm)				
JIS	EIA	L	W	T	B	G
C0603	CC0201	0.60	0.30	0.30	0.15	0.20 min.

• Inside Structure & Material System

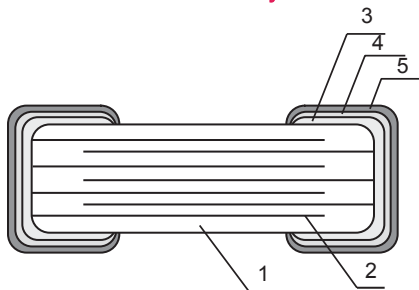

No.	NAME	MATERIAL
		Class 1
(1)	Ceramic Dielectric	CaZrO ₃
(2)	Internal Electrode	Nickel (Ni)
(3)	Termination	Copper (Cu)
(4)		Nickel (Ni)
(5)		Tin (Sn)

• Environmental Information

TDK Corporation established internal product environmental assurance standards that include the six hazardous substances banned by the EU RoHS Directive¹ enforced on July 1, 2006 along with additional substances independently banned by TDK and has successfully completed making general purpose electronic components conform to the RoHS Directive².

1. Abbreviation for Restriction on Hazardous Substances, which refers to the regulation EU Directive 2002/95/EC on hazardous substances by the European Union (EU) effective from July 1, 2006. The Directive bans the use of six specific hazardous substances in electric and electronic devices and products handled within the EU. The six substances are lead, mercury, cadmium, hexavalent chromium, PBB (polybrominated biphenyls), and PBDE (polybrominated diphenyl ethers).
2. This means that, in conformity with the EU Directive 2002/95/EC, lead, cadmium, mercury, hexavalent chromium, and specific bromine-based flame retardants, PBB and PBDE, have not been used, except for exempted applications.

For REACH (SVHC : 15 substances according to ECHA / October 2008) : All TDK MLCC do not contain these 15 substances.

For European Directive 2000/53/CE and 2005/673/CE : Cadmium, Hexavalent Chromium, Mercury, Lead are not contained in all TDK MLCC.

For European Directive 2003/11/CE : Pentabromodiphenyl-ether, Octabromodiphenyl-ether are not contained in all TDK MLCC.

* This series is available through the distribution channel only. Please see www.tdk.com/distributor.php for a list of authorized distributors.