

阅读申明

- 1.本站收集的数据手册和产品资料都来自互联网，版权归原作者所有。如读者和版权方有任何异议请及时告之，我们将妥善解决。
- 2.本站提供的中文数据手册是英文数据手册的中文翻译，其目的是协助用户阅读，该译文无法自动跟随原稿更新，同时也可能存在翻译上的不当。建议读者以英文原稿为参考以便获得更精准的信息。
- 3.本站提供的产品资料，来自厂商的技术支持或者使用者的心得体会等，其内容可能存在描述上的差异，建议读者做出适当判断。
- 4.如需与我们联系，请发邮件到marketing@iczoom.com，主题请标有“数据手册”字样。

Read Statement

1. The datasheets and other product information on the site are all from network reference or other public materials, and the copyright belongs to the original author and original published source. If readers and copyright owners have any objections, please contact us and we will deal with it in a timely manner.
2. The Chinese datasheets provided on the website is a Chinese translation of the English datasheets. Its purpose is for reader's learning exchange only and do not involve commercial purposes. The translation cannot be automatically updated with the original manuscript, and there may also be improper translations. Readers are advised to use the English manuscript as a reference for more accurate information.
3. All product information provided on the website refer to solutions from manufacturers' technical support or users the contents may have differences in description, and readers are advised to take the original article as the standard.
4. If you have any questions, please contact us at marketing@iczoom.com and mark the subject with "Datasheets" .



MULTILAYER CERAMIC CHIP CAPACITORS



C Series Mid Voltage Application

Type: C1005 [EIA CC0402]
C1608 [EIA CC0603]
C2012 [EIA CC0805]
C3216 [EIA CC1206]
C3225 [EIA CC1210]
C4532 [EIA CC1812]
C5750 [EIA CC2220]

Issue date: April 2011



**TDK MLCC
US Catalog**

Version B11

REMINDERS

Please read before using this product

SAFETY REMINDERS



REMINDERS

1. If you intend to use a product listed in this catalog for a purpose that may cause loss of life or other damage, you must contact our company's sales window.
2. We may modify products or discontinue production of a product listed in this catalog without prior notification.
3. We provide "Delivery Specification" that explain precautions for the specifications and safety of each product listed in this catalog. We strongly recommend that you exchange these delivery specifications with customers that use one of these products.
4. If you plan to export a product listed in this catalog, keep in mind that it may be a restricted item according to the "Foreign Exchange and Foreign Trade Control Law". In such cases, it is necessary to acquire export permission in harmony with this law.
5. Any reproduction or transferring of the contents of this catalog is prohibited without prior permission from our company.
6. We are not responsible for problems that occur related to the intellectual property rights or other rights of our company or a third party when you use a product listed in this catalog. We do not grant license of these rights.
7. This catalog only applies to products purchased through our company or one of our company's official agencies. This catalog does not apply to products that are purchased through other third parties.



C Series Mid Voltage Application

Type: C1005, C1608, C2012, C3216, C3225, C4532, C5750

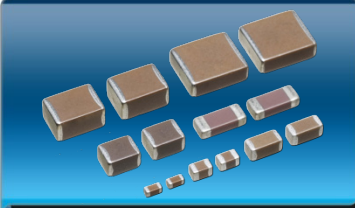

Features



- Unique electrode design allows higher voltage application in smaller case size
- SMT package will help down sizing and lightening of the weight of the product
- A monolithic structure ensures superior mechanical strength and reliability.
- High capacitance has been achieved through precision technologies that enable the use of multiple thinner ceramic dielectric layers.
- Owing to their low ESR and excellent frequency characteristics, these products are optimally suited for high frequency and high-density type power supplies.
- High-accuracy automatic mounting is facilitated through the maintenance of very precise dimensional tolerances.
- Low residual inductance assures superior frequency characteristics.
- Low stray capacitance ensures high conformity with nominal values, thereby simplifying the circuit design process.
- Voltage rating of up to 630V
- High mechanical strength
- No polarity

Applications



- Snubber in switching power supply
- Ringer cap in telephone set and modem
- Flash light in camera
- DSU/TA in ISDN lines
- HID (High Intensity Discharge Lamp)
- Output bypass in power supply
- Driver circuit in plasma display
- Noise bypass in automotive
- Other mid voltage applications

Shape & Dimensions

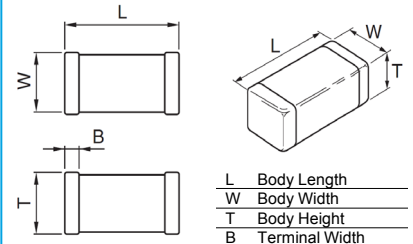

Dimensions in mm

Part Number Construction

Series Name C 3216 X7R 2J 103 K T XXXX

Dimensions L x W (mm)	Length	Width
Case Code		
C1005	1.00 ± 0.05	0.50 ± 0.05
C1608	1.60 ± 0.10	0.80 ± 0.10
C2012	2.00 ± 0.20	1.25 ± 0.20
C3216	3.20 ± 0.20	1.60 ± 0.20
C3225	3.20 ± 0.40	2.50 ± 0.30
C4532	4.50 ± 0.40	3.20 ± 0.40
C5750	5.70 ± 0.40	5.00 ± 0.40

Temperature Characteristic	Capacitance Change	Temperature Range
Characteristics		
C0G	0±30 ppm/°C	-55 to +125°C
X6S	± 22%	-55 to +105°C
X7R	± 15%	-55 to +125°C
X7S	± 22%	-55 to +125°C
X7T	+22/-33%	-55 to +125°C

Rated Voltage (DC)	Voltage (DC)
Code	
2A	100V
2E	250V
2W	450V
2J	630V

Internal Codes	Style
Code	
T	Tape & Reel

Capacitance Tolerance	Tolerance
Code	
J	± 5%
K	± 10%
M	± 20%

Nominal Capacitance (pF)	Capacitance
Code	
0R5	0.5pF
010	1pF
102	1,000pF (1nF)
105	1,000,000pF (1µF)

The capacitance is expressed in three digit codes and in units of pico Farads (pF). The first and second digits identify the first and second significant figures of the capacitance. The third digit identifies the multiplier. R designates a decimal point.









Capacitance Range Chart

C1005 [EIA CC0402]

Capacitance Range Chart

Temperature Characteristics: X7R ($\pm 15\%$), X5R ($\pm 15\%$), Y5V (+22/-82%)
 Rated Voltage: 100V (2A)

Capacitance (pF)	Cap Code	Tolerance	X7S
			2A (100V)
1,000	102	K: $\pm 10\%$ M: $\pm 20\%$	
1,500	152		
2,200	222		
3,300	332		
4,700	472		
6,800	682		
10,000	103		

Standard Thickness

 0.50 mm



Capacitance Range Table

C1005 [EIA CC0402]

Class 2 (Temperature Stable)

Temperature Characteristics: X7S (-55 to +125°C, ±22%)

TDK Part Number (Ordering Code)	Temperature Characteristics	Rated Voltage	Capacitance (pF)	Capacitance Tolerance	Thickness (mm)
C1005X7S2A102K	X7S	100V	1,000	± 10%	0.50 ± 0.05
C1005X7S2A102M	X7S	100V	1,000	± 20%	0.50 ± 0.05
C1005X7S2A152K	X7S	100V	1,500	± 10%	0.50 ± 0.05
C1005X7S2A152M	X7S	100V	1,500	± 20%	0.50 ± 0.05
C1005X7S2A222K	X7S	100V	2,200	± 10%	0.50 ± 0.05
C1005X7S2A222M	X7S	100V	2,200	± 20%	0.50 ± 0.05
C1005X7S2A332K	X7S	100V	3,300	± 10%	0.50 ± 0.05
C1005X7S2A332M	X7S	100V	3,300	± 20%	0.50 ± 0.05
C1005X7S2A472K	X7S	100V	4,700	± 10%	0.50 ± 0.05
C1005X7S2A472M	X7S	100V	4,700	± 20%	0.50 ± 0.05
C1005X7S2A682K	X7S	100V	6,800	± 10%	0.50 ± 0.05
C1005X7S2A682M	X7S	100V	6,800	± 20%	0.50 ± 0.05
C1005X7S2A103K	X7S	100V	10,000	± 10%	0.50 ± 0.05
C1005X7S2A103M	X7S	100V	10,000	± 20%	0.50 ± 0.05



Capacitance Range Chart

C1608 [EIA CC0603]

Capacitance Range Chart

Temperature Characteristics: C0G ($0 \pm 30\text{ppm}/^\circ\text{C}$)
 Rated Voltage: 250V (2E), 100V (2A)

Capacitance (pF)	Cap Code	Tolerance	C0G		
			2E (250V)	2A (100V)	
100	101	J: $\pm 5\%$	█	█	
120	121				
150	151				
180	181				
220	221				
270	271				
330	331				
390	391				
470	471				
560	561				
680	681				
820	821				
1,000	102				█
1,200	122				

Capacitance Range Chart

Temperature Characteristics: X7R ($\pm 15\%$), X7S ($\pm 22\%$)
 Rated Voltage: 100V (2A)

Capacitance (pF)	Cap Code	Tolerance	X7R	X7S
			2A (100V)	2A (100V)
1,000	102	K: $\pm 10\%$ M: $\pm 20\%$	█	
1,500	152			
2,200	222			
3,300	332			
4,700	472			
6,800	682			
10,000	103			
15,000	153			
22,000	223			
33,000	333			█
47,000	473			
68,000	683			
100,000	104			█

Standard Thickness

0.80 mm



Capacitance Range Table

C1608 [EIA CC0603]

Class 1 (Temperature Compensating)

Temperature Characteristics: C0G (-55 to 125°C, 0±30 ppm/°C)

TDK Part Number (Ordering Code)	Temperature Characteristics	Rated Voltage	Capacitance (pF)	Capacitance Tolerance	Thickness (mm)
C1608C0G2A101J	C0G	100V	100	± 5%	0.80 ± 0.10
C1608C0G2A121J	C0G	100V	120	± 5%	0.80 ± 0.10
C1608C0G2A151J	C0G	100V	150	± 5%	0.80 ± 0.10
C1608C0G2A181J	C0G	100V	180	± 5%	0.80 ± 0.10
C1608C0G2A221J	C0G	100V	220	± 5%	0.80 ± 0.10
C1608C0G2A271J	C0G	100V	270	± 5%	0.80 ± 0.10
C1608C0G2A331J	C0G	100V	330	± 5%	0.80 ± 0.10
C1608C0G2A391J	C0G	100V	390	± 5%	0.80 ± 0.10
C1608C0G2A471J	C0G	100V	470	± 5%	0.80 ± 0.10
C1608C0G2A561J	C0G	100V	560	± 5%	0.80 ± 0.10
C1608C0G2A681J	C0G	100V	680	± 5%	0.80 ± 0.10
C1608C0G2A821J	C0G	100V	820	± 5%	0.80 ± 0.10
C1608C0G2A102J	C0G	100V	1,000	± 5%	0.80 ± 0.10
C1608C0G2A122J	C0G	100V	1,200	± 5%	0.80 ± 0.10
C1608C0G2E101J	C0G	250V	100	± 5%	0.80 ± 0.10
C1608C0G2E121J	C0G	250V	120	± 5%	0.80 ± 0.10
C1608C0G2E151J	C0G	250V	150	± 5%	0.80 ± 0.10
C1608C0G2E181J	C0G	250V	180	± 5%	0.80 ± 0.10
C1608C0G2E221J	C0G	250V	220	± 5%	0.80 ± 0.10
C1608C0G2E271J	C0G	250V	270	± 5%	0.80 ± 0.10
C1608C0G2E331J	C0G	250V	330	± 5%	0.80 ± 0.10
C1608C0G2E391J	C0G	250V	390	± 5%	0.80 ± 0.10
C1608C0G2E471J	C0G	250V	470	± 5%	0.80 ± 0.10
C1608C0G2E561J	C0G	250V	560	± 5%	0.80 ± 0.10
C1608C0G2E681J	C0G	250V	680	± 5%	0.80 ± 0.10

Class 2 (Temperature Stable)

Temperature Characteristics: X7R (-55 to +125°C, ±15%)

TDK Part Number (Ordering Code)	Temperature Characteristics	Rated Voltage	Capacitance (pF)	Capacitance Tolerance	Thickness (mm)
C1608X7R2A102K	X7R	100V	1,000	± 10%	0.80 ± 0.10
C1608X7R2A102M	X7R	100V	1,000	± 20%	0.80 ± 0.10
C1608X7R2A152K	X7R	100V	1,500	± 10%	0.80 ± 0.10
C1608X7R2A152M	X7R	100V	1,500	± 20%	0.80 ± 0.10
C1608X7R2A222K	X7R	100V	2,200	± 10%	0.80 ± 0.10
C1608X7R2A222M	X7R	100V	2,200	± 20%	0.80 ± 0.10
C1608X7R2A332K	X7R	100V	3,300	± 10%	0.80 ± 0.10
C1608X7R2A332M	X7R	100V	3,300	± 20%	0.80 ± 0.10
C1608X7R2A472K	X7R	100V	4,700	± 10%	0.80 ± 0.10
C1608X7R2A472M	X7R	100V	4,700	± 20%	0.80 ± 0.10
C1608X7R2A682K	X7R	100V	6,800	± 10%	0.80 ± 0.10
C1608X7R2A682M	X7R	100V	6,800	± 20%	0.80 ± 0.10
C1608X7R2A103K	X7R	100V	10,000	± 10%	0.80 ± 0.10
C1608X7R2A103M	X7R	100V	10,000	± 20%	0.80 ± 0.10
C1608X7R2A153K	X7R	100V	15,000	± 10%	0.80 ± 0.10



Capacitance Range Table

C1608 [EIA CC0603]

Class 2 (Temperature Stable)

Temperature Characteristics: X7R (-55 to +125°C, ±15%), X7S (-55 to +125°C, ±22%)

TDK Part Number (Ordering Code)	Temperature Characteristics	Rated Voltage	Capacitance (pF)	Capacitance Tolerance	Thickness (mm)
C1608X7R2A153M	X7R	100V	15,000	± 20%	0.80 ± 0.10
C1608X7R2A223K	X7R	100V	22,000	± 10%	0.80 ± 0.10
C1608X7R2A223M	X7R	100V	22,000	± 20%	0.80 ± 0.10
C1608X7S2A333K	X7S	100V	33,000	± 10%	0.80 ± 0.10
C1608X7S2A333M	X7S	100V	33,000	± 20%	0.80 ± 0.10
C1608X7S2A473K	X7S	100V	47,000	± 10%	0.80 ± 0.10
C1608X7S2A473M	X7S	100V	47,000	± 20%	0.80 ± 0.10
C1608X7S2A683K	X7S	100V	68,000	± 10%	0.80 ± 0.10
C1608X7S2A683M	X7S	100V	68,000	± 20%	0.80 ± 0.10
C1608X7S2A104K	X7S	100V	100,000	± 10%	0.80 ± 0.10
C1608X7S2A104M	X7S	100V	100,000	± 20%	0.80 ± 0.10



Capacitance Range Chart

C2012 [EIA CC0805]

Capacitance Range Chart

Temperature Characteristics: C0G ($0 \pm 30\text{ppm}/^\circ\text{C}$)
 Rated Voltage: 250V (2E), 100V (2A)

Capacitance (pF)	Cap Code	Tolerance	C0G	
			2E (250V)	2A (100V)
100	101	J: $\pm 5\%$		
220	221			
470	471			
820	821			
1,000	102			
1,200	122			
1,500	152			
1,800	182			
2,200	222			
2,700	272			
3,300	332			
3,900	392			
4,700	472			

Capacitance Range Chart

Temperature Characteristics: X7R ($\pm 15\%$), X7S ($\pm 22\%$), X7T ($+22/-33\%$)
 Rated Voltage: 450V (2W), 250V (2E), 100V (2A)

Capacitance (pF)	Cap Code	Tolerance	X7R		X7S	X7T	
			2E (250V)	2A (100V)	2A (100V)	2W (450V)	2E (250V)
1,000	102	K: $\pm 10\%$ M: $\pm 20\%$					
1,500	152						
2,200	222						
3,300	332						
4,700	472						
6,800	682						
10,000	103						
15,000	153						
22,000	223						
33,000	333						
47,000	473						
68,000	683						
100,000	104						
150,000	154						
220,000	224						
330,000	334						
470,000	474						
1,000,000	105						

Standard Thickness

	0.60 mm
	0.85 mm
	1.25 mm



Capacitance Range Table

C2012 [EIA CC0805]

Class 1 (Temperature Compensating)

Temperature Characteristics: C0G (-55 to 125°C, 0±30 ppm/°C)

TDK Part Number (Ordering Code)	Temperature Characteristics	Rated Voltage	Capacitance (pF)	Capacitance Tolerance	Thickness (mm)
C2012C0G2A101J	C0G	100V	100	± 5%	0.60 ± 0.10
C2012C0G2A221J	C0G	100V	220	± 5%	0.60 ± 0.10
C2012C0G2A471J	C0G	100V	470	± 5%	0.60 ± 0.10
C2012C0G2A102J	C0G	100V	1,000	± 5%	0.60 ± 0.10
C2012C0G2A122J	C0G	100V	1,200	± 5%	0.60 ± 0.10
C2012C0G2A152J	C0G	100V	1,500	± 5%	0.60 ± 0.10
C2012C0G2A182J	C0G	100V	1,800	± 5%	0.85 ± 0.10
C2012C0G2A222J	C0G	100V	2,200	± 5%	0.85 ± 0.10
C2012C0G2A272J	C0G	100V	2,700	± 5%	1.25 ± 0.20
C2012C0G2A332J	C0G	100V	3,300	± 5%	1.25 ± 0.20
C2012C0G2A392J	C0G	100V	3,900	± 5%	1.25 ± 0.20
C2012C0G2A472J	C0G	100V	4,700	± 5%	1.25 ± 0.20
C2012C0G2E101J	C0G	250V	100	± 5%	0.60 ± 0.10
C2012C0G2E821J	C0G	250V	820	± 5%	0.60 ± 0.10
C2012C0G2E102J	C0G	250V	1,000	± 5%	0.85 ± 0.10
C2012C0G2E122J	C0G	250V	1,200	± 5%	0.85 ± 0.10
C2012C0G2E152J	C0G	250V	1,500	± 5%	0.85 ± 0.10
C2012C0G2E182J	C0G	250V	1,800	± 5%	1.25 ± 0.20
C2012C0G2E222J	C0G	250V	2,200	± 5%	1.25 ± 0.20
C2012C0G2E272J	C0G	250V	2,700	± 5%	1.25 ± 0.20

Class 2 (Temperature Stable)

Temperature Characteristics: X7R (-55 to +125°C, ±15%)

TDK Part Number (Ordering Code)	Temperature Characteristics	Rated Voltage	Capacitance (pF)	Capacitance Tolerance	Thickness (mm)
C2012X7R2A102K	X7R	100V	1,000	± 10%	0.85 ± 0.10
C2012X7R2A102M	X7R	100V	1,000	± 20%	0.85 ± 0.10
C2012X7R2A152K	X7R	100V	1,500	± 10%	0.85 ± 0.10
C2012X7R2A152M	X7R	100V	1,500	± 20%	0.85 ± 0.10
C2012X7R2A222K	X7R	100V	2,200	± 10%	0.85 ± 0.10
C2012X7R2A222M	X7R	100V	2,200	± 20%	0.85 ± 0.10
C2012X7R2A332K	X7R	100V	3,300	± 10%	0.85 ± 0.10
C2012X7R2A332M	X7R	100V	3,300	± 20%	0.85 ± 0.10
C2012X7R2A472K	X7R	100V	4,700	± 10%	0.85 ± 0.10
C2012X7R2A472M	X7R	100V	4,700	± 20%	0.85 ± 0.10
C2012X7R2A682K	X7R	100V	6,800	± 10%	0.85 ± 0.10
C2012X7R2A682M	X7R	100V	6,800	± 20%	0.85 ± 0.10
C2012X7R2A103K	X7R	100V	10,000	± 10%	0.85 ± 0.10
C2012X7R2A103M	X7R	100V	10,000	± 20%	0.85 ± 0.10
C2012X7R2A153K	X7R	100V	15,000	± 10%	1.25 ± 0.20
C2012X7R2A153M	X7R	100V	15,000	± 20%	1.25 ± 0.20
C2012X7R2A223K	X7R	100V	22,000	± 10%	1.25 ± 0.20
C2012X7R2A223M	X7R	100V	22,000	± 20%	1.25 ± 0.20
C2012X7R2A333K	X7R	100V	33,000	± 10%	1.25 ± 0.20
C2012X7R2A333M	X7R	100V	33,000	± 20%	1.25 ± 0.20



Capacitance Range Table

C2012 [EIA CC0805]

Class 2 (Temperature Stable)

Temperature Characteristics: X7R (-55 to +125°C, ±15%), X7S (-55 to +125°C, ±22%), X7T (-55 to +125°C, +22/-33%)

TDK Part Number (Ordering Code)	Temperature Characteristics	Rated Voltage	Capacitance (pF)	Capacitance Tolerance	Thickness (mm)
C2012X7R2A473K	X7R	100V	47,000	± 10%	1.25 ± 0.20
C2012X7R2A473M	X7R	100V	47,000	± 20%	1.25 ± 0.20
C2012X7R2A683K	X7R	100V	68,000	± 10%	0.85 ± 0.10
C2012X7R2A683M	X7R	100V	68,000	± 20%	0.85 ± 0.10
C2012X7R2A104K	X7R	100V	100,000	± 10%	1.25 ± 0.20
C2012X7R2A104M	X7R	100V	100,000	± 20%	1.25 ± 0.20
C2012X7R2E102K	X7R	250V	1,000	± 10%	0.85 ± 0.10
C2012X7R2E102M	X7R	250V	1,000	± 20%	0.85 ± 0.10
C2012X7R2E152K	X7R	250V	1,500	± 10%	0.85 ± 0.10
C2012X7R2E152M	X7R	250V	1,500	± 20%	0.85 ± 0.10
C2012X7R2E222K	X7R	250V	2,200	± 10%	0.85 ± 0.10
C2012X7R2E222M	X7R	250V	2,200	± 20%	0.85 ± 0.10
C2012X7R2E332K	X7R	250V	3,300	± 10%	0.85 ± 0.10
C2012X7R2E332M	X7R	250V	3,300	± 20%	0.85 ± 0.10
C2012X7R2E472K	X7R	250V	4,700	± 10%	0.85 ± 0.10
C2012X7R2E472M	X7R	250V	4,700	± 20%	0.85 ± 0.10
C2012X7R2E682K	X7R	250V	6,800	± 10%	1.25 ± 0.20
C2012X7R2E682M	X7R	250V	6,800	± 20%	1.25 ± 0.20
C2012X7R2E103K	X7R	250V	10,000	± 10%	1.25 ± 0.20
C2012X7R2E103M	X7R	250V	10,000	± 20%	1.25 ± 0.20
C2012X7R2E153K	X7R	250V	15,000	± 10%	1.25 ± 0.20
C2012X7R2E153M	X7R	250V	15,000	± 20%	1.25 ± 0.20
C2012X7R2E223K	X7R	250V	22,000	± 10%	1.25 ± 0.20
C2012X7R2E223M	X7R	250V	22,000	± 20%	1.25 ± 0.20
C2012X7S2A154K	X7S	100V	150,000	± 10%	0.85 ± 0.10
C2012X7S2A154M	X7S	100V	150,000	± 20%	0.85 ± 0.10
C2012X7S2A224K	X7S	100V	220,000	± 10%	0.85 ± 0.10
C2012X7S2A224M	X7S	100V	220,000	± 20%	0.85 ± 0.10
C2012X7S2A334K	X7S	100V	330,000	± 10%	1.25 ± 0.20
C2012X7S2A334M	X7S	100V	330,000	± 20%	1.25 ± 0.20
C2012X7S2A474K	X7S	100V	470,000	± 10%	1.25 ± 0.20
C2012X7S2A474M	X7S	100V	470,000	± 20%	1.25 ± 0.20
C2012X7S2A105K	X7S	100V	1,000,000	± 10%	1.25 ± 0.20
C2012X7S2A105M	X7S	100V	1,000,000	± 20%	1.25 ± 0.20
C2012X7T2E333K	X7T	250V	33,000	± 10%	1.25 ± 0.20
C2012X7T2E473K	X7T	250V	47,000	± 10%	1.25 ± 0.20
C2012X7T2E683K	X7T	250V	68,000	± 10%	1.25 ± 0.20
C2012X7T2E104K	X7T	250V	100,000	± 10%	1.25 ± 0.20
C2012X7T2W103K	X7T	450V	10,000	± 10%	0.85 ± 0.10
C2012X7T2W153K	X7T	450V	15,000	± 10%	0.85 ± 0.10
C2012X7T2W223K	X7T	450V	22,000	± 10%	1.25 ± 0.20
C2012X7T2W333K	X7T	450V	33,000	± 10%	1.25 ± 0.20
C2012X7T2W473K	X7T	450V	47,000	± 10%	1.25 ± 0.20



Capacitance Range Chart

C3216 [EIA CC1206]

Capacitance Range Chart

Temperature Characteristics: C0G (0 ± 30ppm/°C)
 Rated Voltage: 630V (2J), 250V (2E), 100V (2A)

Capacitance (pF)	Cap Code	Tolerance	C0G			
			2J (630V)	2E (250V)	2A (100V)	
100	101	J: ± 5%	0.60			
120	121		0.60			
150	151		0.60			
180	181		0.60			
220	221		0.60			
270	271		0.60			
330	331		0.60			
390	391		0.60			
470	471		0.60			
560	561		0.60			
680	681		0.60			
820	821		0.60			
1,000	102		0.60			
1,200	122		0.60			
1,500	152		0.60			
1,800	182		0.60			
2,200	222		0.60			
2,700	272		0.60			
3,300	332		0.60	1.30		
3,900	392		0.60	1.30	0.60	
4,700	472	0.60	1.30	0.60	0.60	
5,600	562	0.60	1.30	0.60	0.60	
6,800	682	0.60	1.30	0.60	0.60	
8,200	822	0.60	1.30	0.60	0.60	
10,000	103	0.60	1.30	0.60	0.60	

Capacitance Range Chart

Temperature Characteristics: X7R (±15%), X7S (±22%), X7T (+22/-33%)
 Rated Voltage: 630V (2J), 450V (2W), 250V (2E), 100V (2A)

Capacitance (pF)	Cap Code	Tolerance	X7R			X7S	X7T		
			2J (630V)	2E (250V)	2A (100V)	2A (100V)	2J (630V)	2W (450V)	2E (250V)
1,000	102	K: ± 10% M: ± 20%	1.15						
1,500	152		1.15						
2,200	222	1.15							
3,300	332	1.15							
4,700	472	1.15							
6,800	682	1.15							
10,000	103	1.15							
15,000	153	1.15							
22,000	223	1.15	1.30			0.60			
33,000	333	1.15	1.30			0.60			
47,000	473	1.15	1.30			0.60			
68,000	683	1.15	1.30			0.60			
100,000	104	1.15	1.30			0.60	0.60		
150,000	154	1.15	1.30			0.60	0.60	0.60	
220,000	224	1.15	1.30			0.60	0.60	0.60	
330,000	334	1.15	1.30			0.60	0.60	0.60	
470,000	474	1.15	1.30			0.60	0.60	0.60	
1,000,000	105	1.15	1.30			0.60	0.60	0.60	
2,200,000	225	1.15	1.30			0.60	0.60	0.60	

Standard Thickness

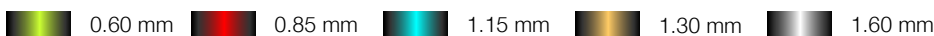



Capacitance Range Table

C3216 [EIA CC1206]

Class 1 (Temperature Compensating)

Temperature Characteristics: C0G (-55 to 125°C, 0±30 ppm/°C)

TDK Part Number (Ordering Code)	Temperature Characteristics	Rated Voltage	Capacitance (pF)	Capacitance Tolerance	Thickness (mm)
C3216C0G2A392J	C0G	100V	3,900	± 5%	0.60 ± 0.10
C3216C0G2A472J	C0G	100V	4,700	± 5%	0.85 ± 0.10
C3216C0G2A562J	C0G	100V	5,600	± 5%	0.85 ± 0.10
C3216C0G2A682J	C0G	100V	6,800	± 5%	1.15 ± 0.10
C3216C0G2A822J	C0G	100V	8,200	± 5%	1.15 ± 0.10
C3216C0G2A103J	C0G	100V	10,000	± 5%	1.15 ± 0.10
C3216C0G2E332J	C0G	250V	3,300	± 5%	0.85 ± 0.10
C3216C0G2E392J	C0G	250V	3,900	± 5%	1.15 ± 0.10
C3216C0G2E472J	C0G	250V	4,700	± 5%	1.15 ± 0.10
C3216C0G2E562J	C0G	250V	5,600	± 5%	1.15 ± 0.10
C3216C0G2E682J	C0G	250V	6,800	± 5%	1.60 ± 0.30
C3216C0G2E822J	C0G	250V	8,200	± 5%	1.60 ± 0.30
C3216C0G2J101J	C0G	630V	100	± 5%	0.60 ± 0.10
C3216C0G2J121J	C0G	630V	120	± 5%	0.60 ± 0.10
C3216C0G2J151J	C0G	630V	150	± 5%	0.60 ± 0.10
C3216C0G2J181J	C0G	630V	180	± 5%	0.60 ± 0.10
C3216C0G2J221J	C0G	630V	220	± 5%	0.60 ± 0.10
C3216C0G2J271J	C0G	630V	270	± 5%	0.60 ± 0.10
C3216C0G2J331J	C0G	630V	330	± 5%	0.60 ± 0.10
C3216C0G2J391J	C0G	630V	390	± 5%	0.60 ± 0.10
C3216C0G2J471J	C0G	630V	470	± 5%	0.85 ± 0.10
C3216C0G2J561J	C0G	630V	560	± 5%	0.85 ± 0.10
C3216C0G2J681J	C0G	630V	680	± 5%	0.85 ± 0.10
C3216C0G2J821J	C0G	630V	820	± 5%	0.85 ± 0.10
C3216C0G2J102J	C0G	630V	1,000	± 5%	0.85 ± 0.10
C3216C0G2J122J	C0G	630V	1,200	± 5%	0.85 ± 0.10
C3216C0G2J152J	C0G	630V	1,500	± 5%	1.15 ± 0.10
C3216C0G2J182J	C0G	630V	1,800	± 5%	1.15 ± 0.10
C3216C0G2J222J	C0G	630V	2,200	± 5%	1.15 ± 0.10
C3216C0G2J272J	C0G	630V	2,700	± 5%	1.60 ± 0.30
C3216C0G2J332J	C0G	630V	3,300	± 5%	1.60 ± 0.30

Class 2 (Temperature Stable)

Temperature Characteristics: X7R (-55 to +125°C, ±15%)

TDK Part Number (Ordering Code)	Temperature Characteristics	Rated Voltage	Capacitance (pF)	Capacitance Tolerance	Thickness (mm)
C3216X7R2A333K	X7R	100V	33,000	± 10%	1.15 ± 0.10
C3216X7R2A333M	X7R	100V	33,000	± 20%	1.15 ± 0.10
C3216X7R2A473K	X7R	100V	47,000	± 10%	1.15 ± 0.10
C3216X7R2A473M	X7R	100V	47,000	± 20%	1.15 ± 0.10
C3216X7R2A683K	X7R	100V	68,000	± 10%	1.60 ± 0.30
C3216X7R2A683M	X7R	100V	68,000	± 20%	1.60 ± 0.30
C3216X7R2A104K	X7R	100V	100,000	± 10%	1.60 ± 0.30
C3216X7R2A104M	X7R	100V	100,000	± 20%	1.60 ± 0.30
C3216X7R2A154K	X7R	100V	150,000	± 10%	1.60 ± 0.30



Capacitance Range Table

C3216 [EIA CC1206]

Class 2 (Temperature Stable)

Temperature Characteristics: X7R (-55 to +125°C, ±15%), X7S (-55 to +125°C, ±22%), X7T (-55 to +125°C, +22/-33%)

TDK Part Number (Ordering Code)	Temperature Characteristics	Rated Voltage	Capacitance (pF)	Capacitance Tolerance	Thickness (mm)
C3216X7R2A154M	X7R	100V	150,000	± 20%	1.60 ± 0.30
C3216X7R2A224K	X7R	100V	220,000	± 10%	1.15 ± 0.10
C3216X7R2A224M	X7R	100V	220,000	± 20%	1.15 ± 0.10
C3216X7R2A334K	X7R	100V	330,000	± 10%	1.30 ± 0.15
C3216X7R2A334M	X7R	100V	330,000	± 20%	1.30 ± 0.15
C3216X7R2A474K	X7R	100V	470,000	± 10%	1.60 ± 0.30
C3216X7R2A474M	X7R	100V	470,000	± 20%	1.60 ± 0.30
C3216X7R2A105K	X7R	100V	1,000,000	± 10%	1.60 ± 0.30
C3216X7R2A105M	X7R	100V	1,000,000	± 20%	1.60 ± 0.30
C3216X7R2E153K	X7R	250V	15,000	± 10%	1.15 ± 0.10
C3216X7R2E153M	X7R	250V	15,000	± 20%	1.15 ± 0.10
C3216X7R2E223K	X7R	250V	22,000	± 10%	1.15 ± 0.10
C3216X7R2E223M	X7R	250V	22,000	± 20%	1.15 ± 0.10
C3216X7R2E333K	X7R	250V	33,000	± 10%	1.60 ± 0.30
C3216X7R2E333M	X7R	250V	33,000	± 20%	1.60 ± 0.30
C3216X7R2E473K	X7R	250V	47,000	± 10%	1.60 ± 0.30
C3216X7R2E473M	X7R	250V	47,000	± 20%	1.60 ± 0.30
C3216X7R2E683K	X7R	250V	68,000	± 10%	1.60 ± 0.30
C3216X7R2E683M	X7R	250V	68,000	± 20%	1.60 ± 0.30
C3216X7R2E104K	X7R	250V	100,000	± 10%	1.60 ± 0.30
C3216X7R2E104M	X7R	250V	100,000	± 20%	1.60 ± 0.30
C3216X7R2J102K	X7R	630V	1,000	± 10%	1.15 ± 0.10
C3216X7R2J102M	X7R	630V	1,000	± 20%	1.15 ± 0.10
C3216X7R2J152K	X7R	630V	1,500	± 10%	1.15 ± 0.10
C3216X7R2J152M	X7R	630V	1,500	± 20%	1.15 ± 0.10
C3216X7R2J222K	X7R	630V	2,200	± 10%	1.15 ± 0.10
C3216X7R2J222M	X7R	630V	2,200	± 20%	1.15 ± 0.10
C3216X7R2J332K	X7R	630V	3,300	± 10%	1.15 ± 0.10
C3216X7R2J332M	X7R	630V	3,300	± 20%	1.15 ± 0.10
C3216X7R2J472K	X7R	630V	4,700	± 10%	1.15 ± 0.10
C3216X7R2J472M	X7R	630V	4,700	± 20%	1.15 ± 0.10
C3216X7R2J682K	X7R	630V	6,800	± 10%	1.15 ± 0.10
C3216X7R2J682M	X7R	630V	6,800	± 20%	1.15 ± 0.10
C3216X7R2J103K	X7R	630V	10,000	± 10%	1.15 ± 0.10
C3216X7R2J103M	X7R	630V	10,000	± 20%	1.15 ± 0.10
C3216X7R2J153K	X7R	630V	15,000	± 10%	1.30 ± 0.15
C3216X7R2J153M	X7R	630V	15,000	± 20%	1.30 ± 0.15
C3216X7R2J223K	X7R	630V	22,000	± 10%	1.30 ± 0.15
C3216X7R2J223M	X7R	630V	22,000	± 20%	1.30 ± 0.15
C3216X7R2J333K	X7R	630V	33,000	± 10%	1.60 ± 0.30
C3216X7R2J333M	X7R	630V	33,000	± 20%	1.60 ± 0.30
C3216X7S2A225K	X7S	100V	2,200,000	± 10%	1.60 ± 0.30
C3216X7S2A225M	X7S	100V	2,200,000	± 20%	1.60 ± 0.30
C3216X7T2E154K	X7T	250V	150,000	± 10%	1.30 ± 0.15



Capacitance Range Table

C3216 [EIA CC1206]

Class 2 (Temperature Stable)

Temperature Characteristics: X7T (-55 to +125°C, +22/-33%)

TDK Part Number (Ordering Code)	Temperature Characteristics	Rated Voltage	Capacitance (pF)	Capacitance Tolerance	Thickness (mm)
C3216X7T2E224K	X7T	250V	220,000	± 10%	1.60 ± 0.30
C3216X7T2W683K	X7T	450V	68,000	± 10%	1.30 ± 0.15
C3216X7T2W104K	X7T	450V	100,000	± 10%	1.60 ± 0.30
C3216X7T2J103K	X7T	630V	10,000	± 10%	0.85 ± 0.10
C3216X7T2J153K	X7T	630V	15,000	± 10%	0.85 ± 0.10
C3216X7T2J223K	X7T	630V	22,000	± 10%	1.15 ± 0.10
C3216X7T2J333K	X7T	630V	33,000	± 10%	1.15 ± 0.10
C3216X7T2J473K	X7T	630V	47,000	± 10%	1.60 ± 0.30



Capacitance Range Chart

C3225 [EIA CC1210]

Capacitance Range Chart

Temperature Characteristics: C0G ($0 \pm 30\text{ppm}/^\circ\text{C}$)
 Rated Voltage: 630V (2J), 250V (2E), 100V (2A)

Capacitance (pF)	Cap Code	Tolerance	C0G		
			2J (630V)	2E (250V)	2A (100V)
3,900	392	J: $\pm 5\%$			
4,700	472				
5,600	562				
6,800	682				
10,000	103				
15,000	153				
22,000	223				
33,000	333				
47,000	473				

Capacitance Range Chart

Temperature Characteristics: X7R ($\pm 15\%$), X7S ($\pm 22\%$), X7T ($+22/-33\%$)
 Rated Voltage: 630V (2J), 450V (2W), 250V (2E), 100V (2A)

Capacitance (pF)	Cap Code	Tolerance	X7R			X7S	X7T		
			2J (630V)	2E (250V)	2A (100V)	2A (100V)	2J (630V)	2W (450V)	2E (250V)
47,000	473	K: $\pm 10\%$ M: $\pm 20\%$							
68,000	683								
100,000	104								
150,000	154								
220,000	224								
330,000	334								
470,000	474								
680,000	684								
1,000,000	105								
2,200,000	225								
3,300,000	335								
4,700,000	475								

Standard Thickness

- 1.25 mm
- 1.60 mm
- 2.00 mm
- 2.30 mm



Capacitance Range Table

C3225 [EIA CC1210]

Class 1 (Temperature Compensating)

Temperature Characteristics: C0G (-55 to 125°C, 0±30 ppm/°C)

TDK Part Number (Ordering Code)	Temperature Characteristics	Rated Voltage	Capacitance (pF)	Capacitance Tolerance	Thickness (mm)
C3225C0G2A153J	C0G	100V	15,000	± 5%	1.30 ± 0.15
C3225C0G2A223J	C0G	100V	22,000	± 5%	1.60 ± 0.30
C3225C0G2A333J	C0G	100V	33,000	± 5%	2.00 ± 0.20
C3225C0G2A473J	C0G	100V	47,000	± 5%	2.30 ± 0.20
C3225C0G2E103J	C0G	250V	10,000	± 5%	1.60 ± 0.30
C3225C0G2E153J	C0G	250V	15,000	± 5%	2.00 ± 0.20
C3225C0G2J392J	C0G	630V	3,900	± 5%	1.30 ± 0.15
C3225C0G2J472J	C0G	630V	4,700	± 5%	1.60 ± 0.30
C3225C0G2J562J	C0G	630V	5,600	± 5%	1.60 ± 0.30
C3225C0G2J682J	C0G	630V	6,800	± 5%	2.00 ± 0.20

Class 2 (Temperature Stable)

Temperature Characteristics: X7R (-55 to +125°C, ±15%), X7S (-55 to +125°C, ±22%), X7T (-55 to +125°C, +22/-33%)

TDK Part Number (Ordering Code)	Temperature Characteristics	Rated Voltage	Capacitance (pF)	Capacitance Tolerance	Thickness (mm)
C3225X7R2A334K	X7R	100V	330,000	± 10%	2.00 ± 0.20
C3225X7R2A334M	X7R	100V	330,000	± 20%	2.00 ± 0.20
C3225X7R2A474K	X7R	100V	470,000	± 10%	2.00 ± 0.20
C3225X7R2A474M	X7R	100V	470,000	± 20%	2.00 ± 0.20
C3225X7R2A684K	X7R	100V	680,000	± 10%	1.60 ± 0.30
C3225X7R2A684M	X7R	100V	680,000	± 20%	1.60 ± 0.30
C3225X7R2A105K	X7R	100V	1,000,000	± 10%	2.00 ± 0.20
C3225X7R2A105M	X7R	100V	1,000,000	± 20%	2.00 ± 0.20
C3225X7R2A225K	X7R	100V	2,200,000	± 10%	2.30 ± 0.20
C3225X7R2A225M	X7R	100V	2,200,000	± 20%	2.30 ± 0.20
C3225X7R2E104K	X7R	250V	100,000	± 10%	2.00 ± 0.20
C3225X7R2E104M	X7R	250V	100,000	± 20%	2.00 ± 0.20
C3225X7R2E154K	X7R	250V	150,000	± 10%	2.00 ± 0.20
C3225X7R2E154M	X7R	250V	150,000	± 20%	2.00 ± 0.20
C3225X7R2E224K	X7R	250V	220,000	± 10%	2.00 ± 0.20
C3225X7R2E224M	X7R	250V	220,000	± 20%	2.00 ± 0.20
C3225X7R2J473K	X7R	630V	47,000	± 10%	2.00 ± 0.20
C3225X7R2J473M	X7R	630V	47,000	± 20%	2.00 ± 0.20
C3225X7R2J683K	X7R	630V	68,000	± 10%	2.00 ± 0.20
C3225X7R2J683M	X7R	630V	68,000	± 20%	2.00 ± 0.20
C3225X7S2A335K	X7S	100V	3,300,000	± 10%	2.00 ± 0.20
C3225X7S2A335M	X7S	100V	3,300,000	± 20%	2.00 ± 0.20
C3225X7S2A475K	X7S	100V	4,700,000	± 10%	2.00 ± 0.20
C3225X7S2A475M	X7S	100V	4,700,000	± 20%	2.00 ± 0.20
C3225X7T2E334K	X7T	250V	330,000	± 10%	2.00 ± 0.20
C3225X7T2W224K	X7T	450V	220,000	± 10%	2.00 ± 0.20
C3225X7T2J104K	X7T	630V	100,000	± 10%	1.60 ± 0.30
C3225X7T2J154K	X7T	630V	150,000	± 10%	2.00 ± 0.20



Capacitance Range Chart

C4532 [EIA CC1812]

Capacitance Range Chart

Temperature Characteristics: C0G ($0 \pm 30\text{ppm}/^\circ\text{C}$)
 Rated Voltage: 630V (2J), 250V (2E), 100V (2A)

Capacitance (pF)	Cap Code	Tolerance	C0G		
			2J (630V)	2E (250V)	2A (100V)
8,200	822	J: $\pm 5\%$			
10,000	103				
15,000	153				
22,000	223				
33,000	333				
47,000	473				
68,000	683				
100,000	104				

Capacitance Range Chart

Temperature Characteristics: X7R ($\pm 15\%$), X7S ($\pm 22\%$), X7T ($+22/-33\%$)
 Rated Voltage: 630V (2J), 450V (2W), 250V (2E), 100V (2A)

Capacitance (pF)	Cap Code	Tolerance	X7R			X7S	X7T		
			2J (630V)	2E (250V)	2A (100V)	2A (100V)	2J (630V)	2W (450V)	2E (250V)
68,000	683	K: $\pm 10\%$ M: $\pm 20\%$							
100,000	104								
150,000	154								
220,000	224								
330,000	334								
470,000	474								
680,000	684								
1,000,000	105								
1,500,000	155								
2,200,000	225								
4,700,000	475								

Standard Thickness

- 1.60 mm
- 2.00 mm
- 2.30 mm
- 2.50 mm
- 3.20 mm



Capacitance Range Table

C4532 [EIA CC1812]

Class 1 (Temperature Compensating)

Temperature Characteristics: C0G (-55 to 125°C, 0±30 ppm/°C)

TDK Part Number (Ordering Code)	Temperature Characteristics	Rated Voltage	Capacitance (pF)	Capacitance Tolerance	Thickness (mm)
C4532C0G2A473J	C0G	100V	47,000	± 5%	2.00 ± 0.20
C4532C0G2A683J	C0G	100V	68,000	± 5%	2.50 ± 0.30
C4532C0G2A104J	C0G	100V	100,000	± 5%	3.20 ± 0.30
C4532C0G2E223J	C0G	250V	22,000	± 5%	1.60 ± 0.30
C4532C0G2E333J	C0G	250V	33,000	± 5%	2.00 ± 0.20
C4532C0G2E473J	C0G	250V	47,000	± 5%	3.20 ± 0.30
C4532C0G2J822J	C0G	630V	8,200	± 5%	1.60 ± 0.30
C4532C0G2J103J	C0G	630V	10,000	± 5%	1.60 ± 0.30
C4532C0G2J153J	C0G	630V	15,000	± 5%	2.50 ± 0.30
C4532C0G2J223J	C0G	630V	22,000	± 5%	3.20 ± 0.30

Class 2 (Temperature Stable)

Temperature Characteristics: X7R (-55 to +125°C, ±15%), X7S (-55 to +125°C, ±22%), X7T (-55 to +125°C, +22/-33%)

TDK Part Number (Ordering Code)	Temperature Characteristics	Rated Voltage	Capacitance (pF)	Capacitance Tolerance	Thickness (mm)
C4532X7R2A684K	X7R	100V	680,000	± 10%	2.30 ± 0.20
C4532X7R2A684M	X7R	100V	680,000	± 20%	2.30 ± 0.20
C4532X7R2A105K	X7R	100V	1,000,000	± 10%	2.30 ± 0.20
C4532X7R2A105M	X7R	100V	1,000,000	± 20%	2.30 ± 0.20
C4532X7R2A155K	X7R	100V	1,500,000	± 10%	2.30 ± 0.20
C4532X7R2A155M	X7R	100V	1,500,000	± 20%	2.30 ± 0.20
C4532X7R2A225K	X7R	100V	2,200,000	± 10%	2.30 ± 0.20
C4532X7R2A225M	X7R	100V	2,200,000	± 20%	2.30 ± 0.20
C4532X7R2E154K	X7R	250V	150,000	± 10%	1.60 ± 0.30
C4532X7R2E154M	X7R	250V	150,000	± 20%	1.60 ± 0.30
C4532X7R2E224K	X7R	250V	220,000	± 10%	2.30 ± 0.20
C4532X7R2E224M	X7R	250V	220,000	± 20%	2.30 ± 0.20
C4532X7R2E334K	X7R	250V	330,000	± 10%	2.30 ± 0.20
C4532X7R2E334M	X7R	250V	330,000	± 20%	2.30 ± 0.20
C4532X7R2E474K	X7R	250V	470,000	± 10%	2.30 ± 0.20
C4532X7R2E474M	X7R	250V	470,000	± 20%	2.30 ± 0.20
C4532X7R2J683K	X7R	630V	68,000	± 10%	1.60 ± 0.30
C4532X7R2J683M	X7R	630V	68,000	± 20%	1.60 ± 0.30
C4532X7R2J104K	X7R	630V	100,000	± 10%	2.30 ± 0.20
C4532X7R2J104M	X7R	630V	100,000	± 20%	2.30 ± 0.20
C4532X7S2A475M	X7S	100V	4,700,000	± 20%	2.30 ± 0.20
C4532X7T2E684K	X7T	250V	680,000	± 10%	1.60 ± 0.30
C4532X7T2E105K	X7T	250V	1,000,000	± 10%	2.50 ± 0.30
C4532X7T2W334K	X7T	450V	330,000	± 10%	1.60 ± 0.30
C4532X7T2W474K	X7T	450V	470,000	± 10%	2.30 ± 0.20
C4532X7T2J154K	X7T	630V	150,000	± 10%	1.60 ± 0.30
C4532X7T2J224K	X7T	630V	220,000	± 10%	2.00 ± 0.20



Capacitance Range Chart

C5750 [EIA CC2220]

Capacitance Range Chart

Temperature Characteristics: X7R ($\pm 15\%$), X7S ($\pm 22\%$), X7T ($+22/-33\%$), X6S ($\pm 22\%$)
 Rated Voltage: 630V (2J), 450V (2W), 250V (2E), 100V (2A)

Capacitance (pF)	Cap Code	Tolerance	X7R			X7S	X7T			X6S
			2J (630V)	2E (250V)	2A (100V)	2A (100V)	2J (630V)	2W (450V)	2E (250V)	2W (450V)
150,000	154	K: $\pm 10\%$ M: $\pm 20\%$								
220,000	224									
330,000	334									
470,000	474									
680,000	684									
1,000,000	105									
1,500,000	155									
2,200,000	225									
3,300,000	335									
4,700,000	475									
10,000,000	106									
15,000,000	156									

Standard Thickness

- 1.60 mm
- 2.00 mm
- 2.30 mm
- 2.50 mm



Capacitance Range Table

C5750 [EIA CC2220]

Class 2 (Temperature Stable)

Temperature Characteristics: X7R (-55 to +125°C, ±15%), X7S (-55 to +125°C, ±22%), X7T (-55 to +125°C, +22/-33%), X6S (-55 to +105°C, ±22%)

TDK Part Number (Ordering Code)	Temperature Characteristics	Rated Voltage	Capacitance (pF)	Capacitance Tolerance	Thickness (mm)
C5750X7R2A105K	X7R	100V	1,000,000	± 10%	2.30 ± 0.20
C5750X7R2A105M	X7R	100V	1,000,000	± 20%	2.30 ± 0.20
C5750X7R2A155K	X7R	100V	1,500,000	± 10%	2.30 ± 0.20
C5750X7R2A155M	X7R	100V	1,500,000	± 20%	2.30 ± 0.20
C5750X7R2A225K	X7R	100V	2,200,000	± 10%	2.30 ± 0.20
C5750X7R2A225M	X7R	100V	2,200,000	± 20%	2.30 ± 0.20
C5750X7R2A335K	X7R	100V	3,300,000	± 10%	2.30 ± 0.20
C5750X7R2A335M	X7R	100V	3,300,000	± 20%	2.30 ± 0.20
C5750X7R2A475K	X7R	100V	4,700,000	± 10%	2.30 ± 0.20
C5750X7R2A475M	X7R	100V	4,700,000	± 20%	2.30 ± 0.20
C5750X7R2E334K	X7R	250V	330,000	± 10%	1.60 ± 0.30
C5750X7R2E334M	X7R	250V	330,000	± 20%	1.60 ± 0.30
C5750X7R2E474K	X7R	250V	470,000	± 10%	2.30 ± 0.20
C5750X7R2E474M	X7R	250V	470,000	± 20%	2.30 ± 0.20
C5750X7R2E684K	X7R	250V	680,000	± 10%	2.30 ± 0.20
C5750X7R2E684M	X7R	250V	680,000	± 20%	2.30 ± 0.20
C5750X7R2E105K	X7R	250V	1,000,000	± 10%	2.30 ± 0.20
C5750X7R2E105M	X7R	250V	1,000,000	± 20%	2.30 ± 0.20
C5750X7R2J154K	X7R	630V	150,000	± 10%	1.60 ± 0.30
C5750X7R2J154M	X7R	630V	150,000	± 20%	1.60 ± 0.30
C5750X7R2J224K	X7R	630V	220,000	± 10%	2.30 ± 0.20
C5750X7R2J224M	X7R	630V	220,000	± 20%	2.30 ± 0.20
C5750X7S2A106M	X7S	100V	10,000,000	± 20%	2.30 ± 0.20
C5750X7S2A156M	X7S	100V	15,000,000	± 20%	2.50 ± 0.30
C5750X7T2E155K	X7T	250V	1,500,000	± 10%	2.00 ± 0.20
C5750X7T2E225K	X7T	250V	2,200,000	± 10%	2.50 ± 0.30
C5750X7T2W684K	X7T	450V	680,000	± 10%	2.00 ± 0.20
C5750X7T2W105K	X7T	450V	1,000,000	± 10%	2.50 ± 0.30
C5750X7T2J334K	X7T	630V	330,000	± 10%	2.00 ± 0.20
C5750X7T2J474K	X7T	630V	470,000	± 10%	2.50 ± 0.30
C5750X6S2W105K	X6S	450V	1,000,000	± 10%	2.50 ± 0.30
C5750X6S2W225K	X6S	450V	2,200,000	± 10%	2.50 ± 0.30



No.	Item	Performance	Test or Inspection Method																					
1	External Appearance	No defects which may affect performance.	Inspect with magnifying glass (3×).																					
2	Insulation Resistance	10,000MΩ or 500MΩ•μF min. whichever smaller.	Apply rated voltage for 60s. As for the rated voltage 630V DC, apply 500V DC.																					
3	Voltage Proof	Withstand test voltage without insulation breakdown or other damage.	<table border="1"> <thead> <tr> <th>Class</th> <th>Rated Voltage</th> <th>Apply voltage</th> </tr> </thead> <tbody> <tr> <td rowspan="2">Class 1</td> <td>100V</td> <td>3 × rated voltage</td> </tr> <tr> <td>Over 100V</td> <td>1.5 × rated voltage</td> </tr> <tr> <td rowspan="2">Class 2</td> <td>100V</td> <td>2.5 × rated voltage</td> </tr> <tr> <td>Over 100V</td> <td>1.5 × rated voltage</td> </tr> </tbody> </table>	Class	Rated Voltage	Apply voltage	Class 1	100V	3 × rated voltage	Over 100V	1.5 × rated voltage	Class 2	100V	2.5 × rated voltage	Over 100V	1.5 × rated voltage								
			Class	Rated Voltage	Apply voltage																			
Class 1	100V	3 × rated voltage																						
	Over 100V	1.5 × rated voltage																						
Class 2	100V	2.5 × rated voltage																						
	Over 100V	1.5 × rated voltage																						
			Above DC voltage shall be applied for 1 to 5s. Charge / discharge current shall not exceed 50mA.																					
4	Capacitance	Within the specified tolerance.	<table border="1"> <thead> <tr> <th>Class</th> <th>Rated Capacitance</th> <th>Measuring Frequency</th> <th>Measuring voltage</th> </tr> </thead> <tbody> <tr> <td rowspan="2">Class 1</td> <td>1000pF and under</td> <td>1MHz±10%</td> <td rowspan="2">0.5 - 5 V_{rms}</td> </tr> <tr> <td>Over 1000pF</td> <td>1kHz ± 10%</td> </tr> <tr> <td rowspan="2">Class 2</td> <td>10uF and under</td> <td>1kHz±10%</td> <td>0.5±0.2V_{rms}</td> </tr> <tr> <td>Over 10uF</td> <td>120Hz±20%</td> <td>1.0±0.2V_{rms}</td> </tr> <tr> <td colspan="3"></td> <td>0.5±0.2 V_{rms}</td> </tr> </tbody> </table>	Class	Rated Capacitance	Measuring Frequency	Measuring voltage	Class 1	1000pF and under	1MHz±10%	0.5 - 5 V _{rms}	Over 1000pF	1kHz ± 10%	Class 2	10uF and under	1kHz±10%	0.5±0.2V _{rms}	Over 10uF	120Hz±20%	1.0±0.2V _{rms}				0.5±0.2 V _{rms}
			Class	Rated Capacitance	Measuring Frequency	Measuring voltage																		
Class 1	1000pF and under	1MHz±10%	0.5 - 5 V _{rms}																					
	Over 1000pF	1kHz ± 10%																						
Class 2	10uF and under	1kHz±10%	0.5±0.2V _{rms}																					
	Over 10uF	120Hz±20%	1.0±0.2V _{rms}																					
			0.5±0.2 V _{rms}																					
5	Q (Class 1)	1,000 min.	See No.4 in this table for measuring condition.																					
6	Dissipation Factor (Class 2)	T.C.	See No.4 in this table for measuring condition.																					
		D.F.																						
		X7R		0.05 max.																				
		X7S		0.05 max.																				
X7T	0.025 max.																							
7	Temperature Characteristics of Capacitance (Class 1)	T.C.	Temperature coefficient shall be calculated based on values at 25°C and 85°C temperature. Measuring temperature below 20°C shall be -10°C and -25°C.																					
		Temperature Coefficient																						
		COG		0 ± 30 (ppm/°C)																				
		Capacitance drift within ± 0.2%																						

C Series – Mid Voltage Application

General Specifications

No.	Item	Performance	Test or Inspection Method																		
8	Temperature Characteristics of Capacitance (Class 2)	Capacitance Change (%) <table border="1" style="margin-left: 20px;"> <thead> <tr> <th colspan="2">No Voltage Applied</th> </tr> </thead> <tbody> <tr> <td>X7R:</td> <td>± 15%</td> </tr> <tr> <td>X7S:</td> <td>± 22%</td> </tr> <tr> <td>X7T:</td> <td>+22/-33%</td> </tr> </tbody> </table>	No Voltage Applied		X7R:	± 15%	X7S:	± 22%	X7T:	+22/-33%	Capacitance shall be measured by the steps shown in the following table after thermal equilibrium is obtained for each step. ΔC be calculated ref. STEP 3 reading <table border="1" style="margin-left: 20px;"> <thead> <tr> <th>Step</th> <th>Temperature (°C)</th> </tr> </thead> <tbody> <tr> <td>1</td> <td>Reference temp. ± 2</td> </tr> <tr> <td>2</td> <td>Min. operating temp. ± 2</td> </tr> <tr> <td>3</td> <td>Reference temp. ± 2</td> </tr> <tr> <td>4</td> <td>Max. operating temp. ± 2</td> </tr> </tbody> </table>	Step	Temperature (°C)	1	Reference temp. ± 2	2	Min. operating temp. ± 2	3	Reference temp. ± 2	4	Max. operating temp. ± 2
No Voltage Applied																					
X7R:	± 15%																				
X7S:	± 22%																				
X7T:	+22/-33%																				
Step	Temperature (°C)																				
1	Reference temp. ± 2																				
2	Min. operating temp. ± 2																				
3	Reference temp. ± 2																				
4	Max. operating temp. ± 2																				
9	Robustness of Terminations	No sign of termination coming off, breakage of ceramic, or other abnormal signs.	Reflow solder the capacitors on P.C. board (shown in Appendix 1a or Appendix 1b) and apply a pushing force of 2N (C1005) or 5N (C1608, C2012, C3216, C3225, C4532, C5750) with 10 ± 1 s. <div style="text-align: center; margin-top: 10px;"> </div>																		
10	Bending	No mechanical damage.	Reflow solder the capacitors on P.C. board (shown in Appendix 2a or Appendix 2b) and bend 1mm. <div style="text-align: center; margin-top: 10px;"> </div>																		
11	Solderability	New solder to cover over 75% of termination. 25% may have pin holes or rough spots but not concentrated in one spot. Ceramic surface of A sections shall not be exposed due to melting or shifting of termination material. <div style="text-align: center; margin-top: 10px;"> </div>	Completely soak both terminations in solder at $235 \pm 5^\circ\text{C}$ for 2 ± 0.5 s. Solder : H63A (JIS Z 3282) Flux : Isopropyl alcohol (JIS K 8839) Rosin (JIS K 5902) 25% solid solution.																		

No.	Item	Performance	Test or Inspection Method		
12	Resistance to solder heat		Completely soak both terminations in solder at $260 \pm 5^\circ\text{C}$ for $5 \pm 1\text{s}$. Preheating condition Temp. : $150 \pm 10^\circ\text{C}$ Time : 1 to 2min. Flux: Isopropyl alcohol (JIS K 8839) Rosin (JIS K 5902) 25% solid solution. Solder: H63A (JIS Z 3282) Leave the capacitor in ambient conditions for 6 to 24h (Class 1) or $24 \pm 2\text{h}$ (Class 2) before measurement.		
	External appearance	No cracks are allowed and terminations shall be covered at least 60% with new solder			
	Capacitance	Characteristics		Change from the value before test	
		Class 1		C0G	$\pm 2.5\%$
		Class 2		X7R	$\pm 7.5\%$
				X7S	
	X7T				
	Q (Class 1)	1,000 min.			
	D.F. (Class 2)	Meet the initial spec.			
	Insulation Resistance	Meet the initial spec.			
Voltage Proof	No insulation breakdown or other damage.				
13	Vibration		Reflow solder the capacitor on a P.C. board (shown in Appendix 1a or Appendix 1b) before testing. Vibrate the capacitor with amplitude of 1.5mm P-P sweeping the frequencies from 10Hz to 55Hz and back to 10Hz in about 1min. Repeat this for 2h each in 3 perpendicular directions.		
	External appearance	No mechanical damage.			
	Capacitance	Characteristics		Change from the value before test	
		Class 1		C0G	$\pm 2.5\%$
		Class 2		X7R	$\pm 7.5\%$
				X7S	
	X7T				
	Q (Class 1)	1,000 min.			
	D.F. (Class 2)	Meet the initial spec.			



No.	Item	Performance	Test or Inspection Method			
14	Temperature cycle		Reflow solder the capacitors on a P.C. board (shown in Appendix 1a or Appendix 1b) before testing. Expose the capacitor in the condition step1 through step 4, and repeat 5 times consecutively. Leave the capacitor in ambient conditions for 6 to 24h (Class 1) or 24±2h (Class 2) before measurement.			
	External appearance	No mechanical damage.				
	Capacitance	Characteristics		Change from the value before test		
		Class 1			C0G	±2.5 %
		Class 2			X7R	± 7.5 %
	X7S			X7T		
	Q (Class 1)	1,000 min.				
D.F. (Class 2)	Meet the initial spec.					
Insulation Resistance	Meet the initial spec.					
Voltage Proof	No insulation breakdown or other damage.					
15	Moisture Resistance (Steady State)		Reflow solder the capacitor on P.C. board (shown in Appendix 1a or Appendix 1b) before testing. Leave at temperature 40±2°C, 90 to 95%RH for 500 +24,0h. Leave the capacitor in ambient condition for 6 to 24h (Class1) or 24±2h (Class 2) before measurement.			
	External appearance	No mechanical damage.				
	Capacitance	Characteristics		Change from the value before test		
		Class 1			C0G	± 5 %
		Class 2			X7R	± 12.5 %
	X7S			X7T		
	Q (Class 1)	350 min.				
D.F. (Class 2)	Characteristics X7R: 200% of initial spec. max. X7S: 200% of initial spec. max X7T: 200% of initial spec. max					
Insulation Resistance	1,000MΩ or 50MΩ•μF min. whichever smaller.					

Step	Temperature (°C)	Time (min.)
1	Min. operating temp. ±3	30 ± 3
2	Reference Temp.	2 – 5
3	Max. operating temp. ± 2	30 ± 2
4	Reference Temp.	2 - 5



General Specifications

C Series – Mid Voltage Application

No.	Item	Performance	Test or Inspection Method												
16	Moisture Resistance														
	External appearance	No mechanical damage.	Reflow solder the capacitors on P.C. board (shown in Appendix 1a or Appendix 1b) before testing.												
	Capacitance	<table border="1"> <thead> <tr> <th colspan="2">Characteristics</th> <th>Change from the value before test</th> </tr> </thead> <tbody> <tr> <td>Class 1</td> <td>C0G</td> <td>± 7.5 %</td> </tr> <tr> <td rowspan="3">Class 2</td> <td>X7R</td> <td rowspan="3">± 12.5 %</td> </tr> <tr> <td>X7S</td> </tr> <tr> <td>X7T</td> </tr> </tbody> </table>		Characteristics		Change from the value before test	Class 1	C0G	± 7.5 %	Class 2	X7R	± 12.5 %	X7S	X7T	Apply the rated voltage at temperature 40±2°C and 90 to 95%RH for 500 +24,0h.
		Characteristics		Change from the value before test											
		Class 1	C0G	± 7.5 %											
	Class 2	X7R	± 12.5 %												
X7S															
X7T															
		Charge/discharge current shall not exceed 50mA.													
		Leave the capacitor in ambient conditions for 6 to 24h (Class 1) or 24±2h (Class 2) before measurement.													
		Voltage conditioning (only for class 2): Voltage treat the capacitors under testing temperature and voltage for 1 hour.													
Q (Class 1)		200 min.													
D.F. (Class 2)		Characteristics X7R: 200% of initial spec. max. X7S: 200% of initial spec. max X7T: 200% of initial spec. max	Leave the capacitors in ambient condition for 24±2h before measurement. Use this measurement for initial value.												
Insulation Resistance		500MΩ or 25MΩ•μF min. whichever smaller.													
17	Life														
	External appearance	No mechanical damage.	Reflow solder the capacitor on P.C. board (shown in Appendix 1a or Appendix 1b) before testing.												
	Capacitance	<table border="1"> <thead> <tr> <th colspan="2">Characteristics</th> <th>Change from the value before test</th> </tr> </thead> <tbody> <tr> <td>Class 1</td> <td>C0G</td> <td>± 3 %</td> </tr> <tr> <td rowspan="3">Class 2</td> <td>X7R</td> <td rowspan="3">± 15 %</td> </tr> <tr> <td>X7S</td> </tr> <tr> <td>X7T</td> </tr> </tbody> </table>		Characteristics		Change from the value before test	Class 1	C0G	± 3 %	Class 2	X7R	± 15 %	X7S	X7T	Apply voltage at 125±2°C for 1,000 +48, 0h. Applied voltage is 1xRV. Some items may be tested at higher voltage (1.2x, 1.5x or 2xRV).
		Characteristics		Change from the value before test											
		Class 1	C0G	± 3 %											
	Class 2	X7R	± 15 %												
X7S															
X7T															
		Charge/discharge current shall not exceed 50mA.													
		Leave the capacitors in ambient condition for 6 to 24h (Class 1) or 24±2h (Class 2) before measurement.													
		Voltage conditioning (only for class 2): Voltage treat the capacitor under testing temperature and voltage for 1 hour.													
Q (Class 1)		350 min.													
D.F. (Class 2)		Characteristics X7R: 200% of initial spec. max. X7S: 200% of initial spec. max X7T: 200% of initial spec. max	Leave the capacitor in ambient conditions for 24±2h before measurement. Use this measurement for initial value.												
Insulation Resistance		1,000MΩ or 50MΩ•μF min. whichever smaller.													

*As for the initial measurement of capacitors (Class 2) on number 8, 12, 13, 14 and 15, leave capacitor at 150 –10, 0°C for 1 hour and measure the value after leaving capacitor for 24±2h in ambient condition.

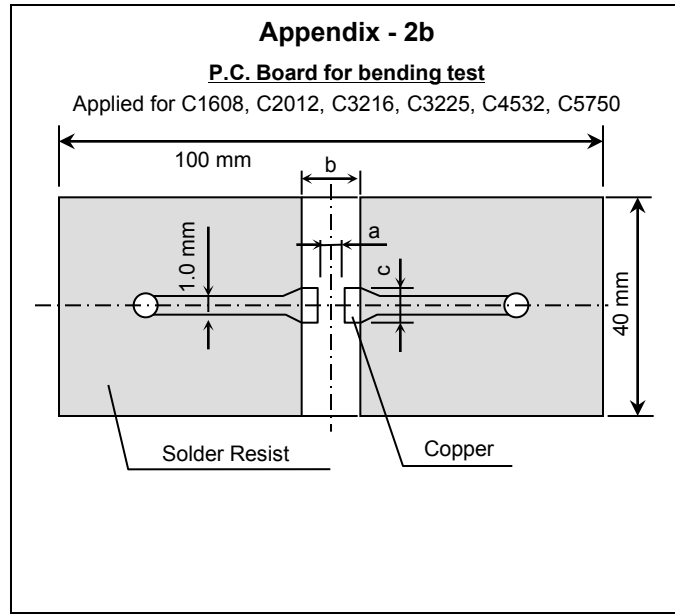
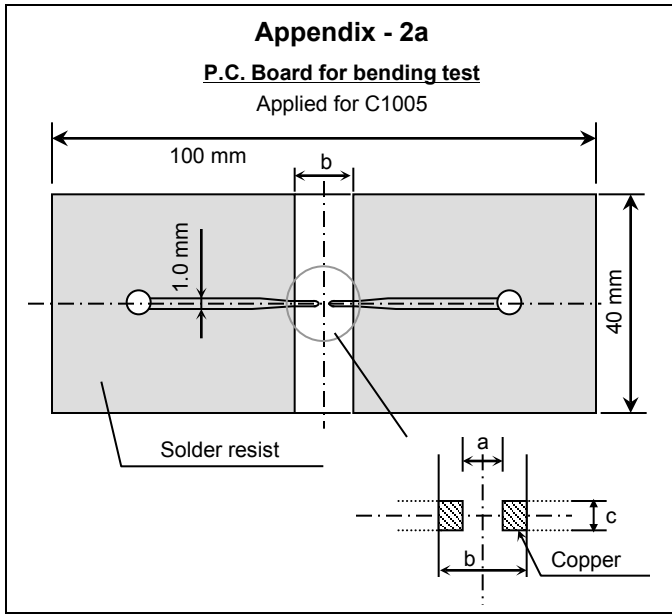
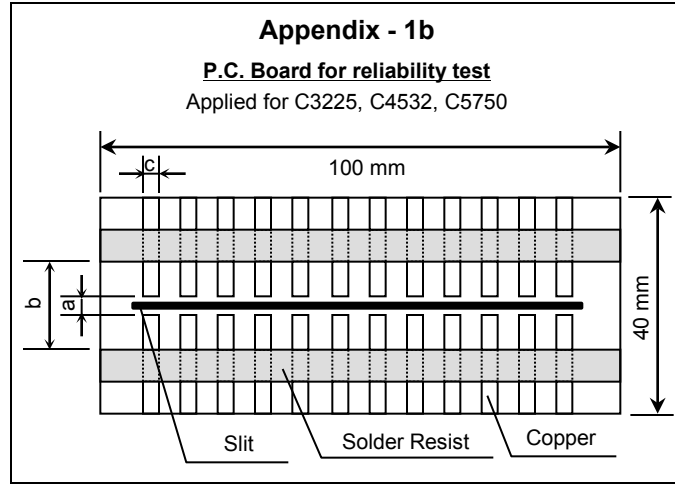
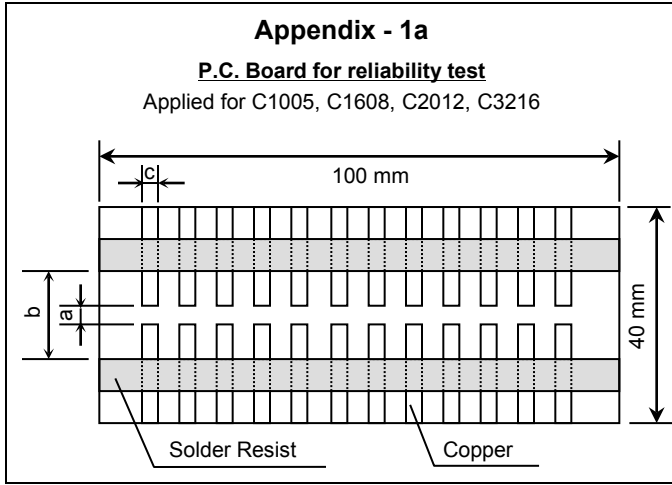

Material : Glass Epoxy (As per JIS C6484 GE4)

P.C. Board thickness : Appendix-2a 0.8mm
Appendix-1a, 1b, 2b 1.6mm

- Copper (thickness 0.035mm)
- Solder resist

Case Code		Dimensions (mm)		
JIS	EIA	a	b	c
C1005	CC0402	0.4	1.5	0.5
C1608	CC0603	1.0	3.0	1.2
C2012	CC0805	1.2	4.0	1.65
C3216	CC1206	2.2	5.0	2.0
C3225	CC1210	2.2	5.0	2.9
C4532	CC1812	3.5	7.0	3.7
C5750	CC2220	4.5	8.0	5.6

Soldering Information

C Series – Mid Voltage Application

Recommended Soldering Land Pattern

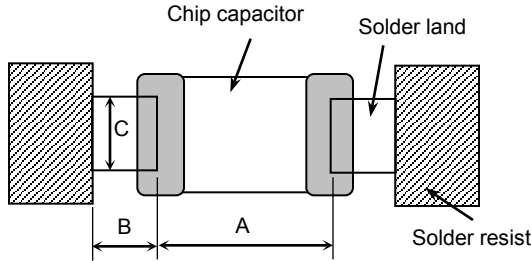

Wave Soldering Unit: mm

Type	C1608 [CC0603]	C2012 [CC0805]	C3216 [CC1206]
A	0.7 - 1.0	1.0 - 1.3	2.1 - 2.5
B	0.8 - 1.0	1.0 - 1.2	1.1 - 1.3
C	0.6 - 0.8	0.8 - 1.1	1.0 - 1.3

Reflow Soldering Unit: mm

Type	C1005 [CC0402]	C1608 [CC0603]	C2012 [CC0805]
A	0.3 - 0.5	0.6 - 0.8	0.9 - 1.2
B	0.35 - 0.45	0.6 - 0.8	0.7 - 0.9
C	0.4 - 0.6	0.6 - 0.8	0.9 - 1.2

Reflow Soldering Unit: mm

Type	C3216 [CC1206]	C3225 [CC1210]	C4532 [CC1812]	C5750 [CC2220]
A	2.0 - 2.4	2.0 - 2.4	3.1 - 3.7	4.1 - 4.8
B	1.0 - 1.2	1.0 - 1.2	1.2 - 1.4	1.2 - 1.4
C	1.1 - 1.6	1.9 - 2.5	2.4 - 3.2	4.0 - 5.0

Recommended Solder Amount

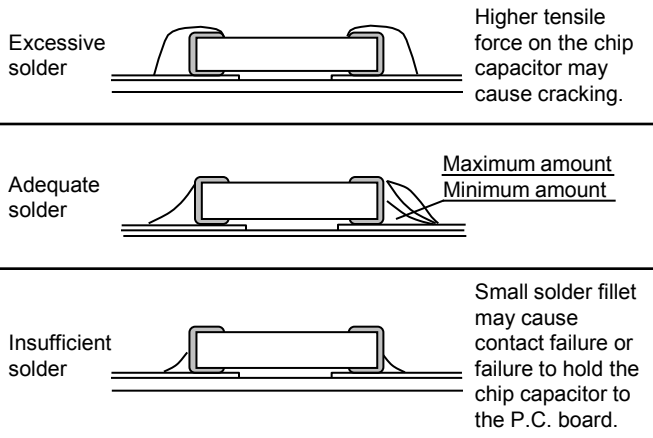

Recommended Soldering Profile

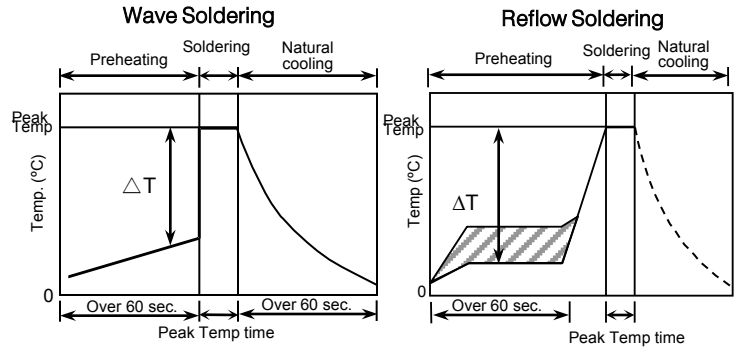

Manual soldering (Solder iron)

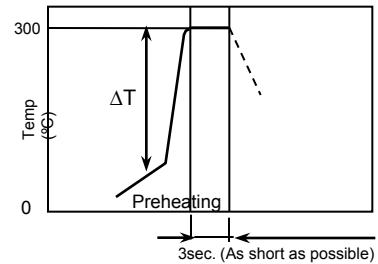

Recommended soldering duration

Solder	Temp./Dura.	Wave Soldering		Reflow Soldering	
		Peak temp (°C)	Duration (sec.)	Peak temp (°C)	Duration (sec.)
Sn-Pb Solder		250 max.	3 max.	230 max.	20 max.
Lead-Free Solder		260 max.	5 max.	260 max.	10 max.

Recommended solder compositions

- Sn-37Pb (Sn-Pb solder)
- Sn-3.0Ag-0.5Cu (Lead Free Solder)

Preheating Condition

Soldering	Case Size - JIS (EIA)	Temp. (°C)
Wave soldering	C1608(CC0603), C2012(CC0805), C3216(CC1206)	$\Delta T \leq 150$
	C1005(CC0402), C1608(CC0603), C2012(CC0805), C3216(CC1206)	$\Delta T \leq 150$
Reflow soldering	C3225(CC1210), C4532(CC1812), C5750(CC2220)	$\Delta T \leq 130$
	C1005(CC0402), C1608(CC0603), C2012(CC0805), C3216(CC1206)	$\Delta T \leq 150$
Manual soldering	C3225(CC1210), C4532(CC1812), C5750(CC2220)	$\Delta T \leq 130$



Packaging Information

C Series – Mid Voltage Application

Carrier Tape Configuration

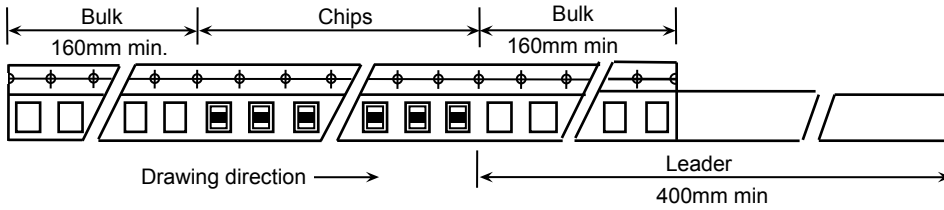

Peel Back Force (Top Tape)

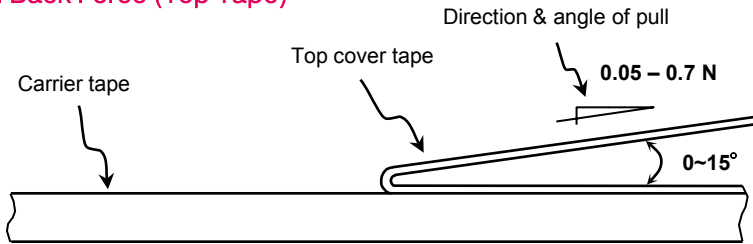

- Carrier tape shall be flexible enough to be wound around a minimum radius of 30mm with components in tape.
- The missing of components shall be less than 0.1%
- Components shall not stick to the cover tape.
- The cover tape shall not protrude beyond the edges of the carrier tape not shall cover the sprocket holes.

Chip Quantity Per Reel and Structure of Reel (Paper & Plastic)

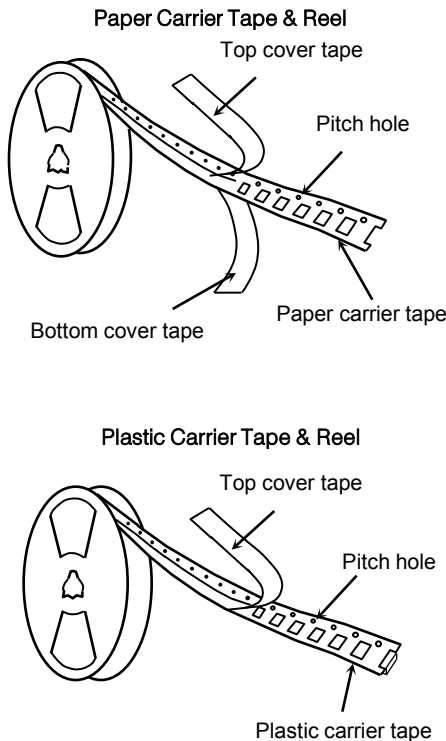

Case Code		Chip Thickness	Taping Material	Chip quantity (pcs.)		
JIS	EIA			φ178mm (7") reel	φ330mm (13") reel	
C1005	CC0402	0.50 mm	Paper	10,000	50,000	
C1608	CC0603	0.80 mm	Paper	4,000	10,000	
C2012	CC0805	0.60 mm	Paper/Plastic	4,000	20,000	
		0.85 mm	Plastic		10,000	
		1.25 mm			2,000	
C3216	CC1206	0.60 mm	Paper	4,000	10,000	
		0.85 mm	Paper/Plastic			
		1.15 mm	Plastic			2,000
		1.30 mm				
		1.60 mm				
C3225	CC1210	1.15 mm	Plastic	2,000	10,000	
		1.25 mm				
		1.30 mm				
		1.60 mm				
		2.00 mm				
C4532	CC1812	2.30 mm	Plastic	1,000	3,000	
		2.50 mm				
		2.80 mm				
		3.20 mm				
		2.50 mm				
C5750	CC2220	1.60 mm	Plastic	500	3,000	
		2.00 mm				
		2.30 mm				
		2.50 mm				
		2.80 mm				



Additional Information

C Series – Mid Voltage Application

• Shape & Dimensions

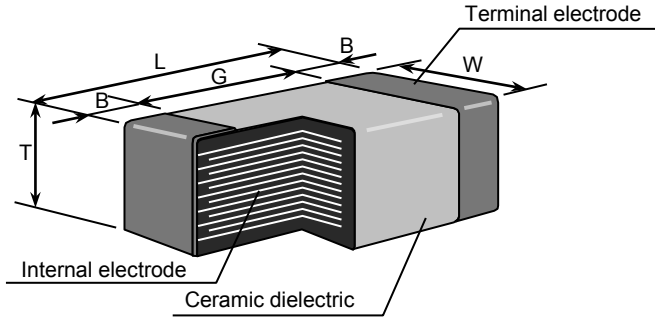

• Inside Structure & Material System

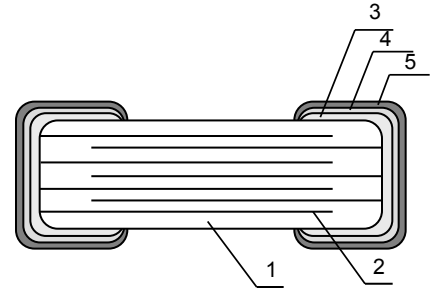

Case Code		Dimensions (mm)				
JIS	EIA	L	W	T	B	G
C1005	CC0402	1.00	0.50	0.50	0.25	0.35 min.
C1608	CC0603	1.60	0.80	0.80	0.20	0.30 min.
C2012	CC0805	2.00	1.20	0.60	0.20 min.	0.50 min.
				0.85		
				1.25		
C3216	CC1206	3.20	1.60	0.60	0.20 min.	1.00 min.
				0.85		
				1.15		
				1.30		
C3225	CC1210	3.20	2.50	1.60	0.20 min.	1.00 min.
				1.25		
				1.30		
				1.60		
				2.00		
				2.30		
C4532	CC1812	4.50	3.20	1.60	0.20 min.	2.00 min.
				2.00		
				2.30		
				2.50		
				2.80		
C5750	CC2220	5.70	5.00	3.20	0.20 min.	2.00 min.
				1.60		
				2.00		
				2.30		
				2.50		
				2.80		

No.	NAME	MATERIAL	
		Class 1	Class 2
(1)	Ceramic Dielectric	CaZrO ₃	BaTiO ₃
(2)	Internal Electrode	Nickel (Ni)	
(3)	Termination	Copper (Cu)	
(4)		Nickel (Ni)	
(5)		Tin (Sn)	

• Environmental Information

TDK Corporation established internal product environmental assurance standards that include the six hazardous substances banned by the EU RoHS Directive¹ enforced on July 1, 2006 along with additional substances independently banned by TDK and has successfully completed making general purpose electronic components conform to the RoHS Directive².

1. Abbreviation for Restriction on Hazardous Substances, which refers to the regulation EU Directive 2002/95/EC on hazardous substances by the European Union (EU) effective from July 1, 2006. The Directive bans the use of six specific hazardous substances in electric and electronic devices and products handled within the EU. The six substances are lead, mercury, cadmium, hexavalent chromium, PBB (polybrominated biphenyls), and PBDE (polybrominated diphenyl ethers).
2. This means that, in conformity with the EU Directive 2002/95/EC, lead, cadmium, mercury, hexavalent chromium, and specific bromine-based flame retardants, PBB and PBDE, have not been used, except for exempted applications.

For REACH (SVHC : 15 substances according to ECHA / October 2008) : All TDK MLCC do not contain these 15 substances.

For European Directive 2000/53/CE and 2005/673/CE : Cadmium, Hexavalent Chromium, Mercury, Lead are not contained in all TDK MLCC.

For European Directive 2003/11/CE : Pentabromodiphenyl-ether, Octabromodiphenyl-ether are not contained in all TDK MLCC.