

阅读申明

- 1.本站收集的数据手册和产品资料都来自互联网，版权归原作者所有。如读者和版权方有任何异议请及时告之，我们将妥善解决。
- 2.本站提供的中文数据手册是英文数据手册的中文翻译，其目的是协助用户阅读，该译文无法自动跟随原稿更新，同时也可能存在翻译上的不当。建议读者以英文原稿为参考以便获得更精准的信息。
- 3.本站提供的产品资料，来自厂商的技术支持或者使用者的心得体会等，其内容可能存在描述上的差异，建议读者做出适当判断。
- 4.如需与我们联系，请发邮件到marketing@iczoom.com，主题请标有“数据手册”字样。

Read Statement

1. The datasheets and other product information on the site are all from network reference or other public materials, and the copyright belongs to the original author and original published source. If readers and copyright owners have any objections, please contact us and we will deal with it in a timely manner.
2. The Chinese datasheets provided on the website is a Chinese translation of the English datasheets. Its purpose is for reader's learning exchange only and do not involve commercial purposes. The translation cannot be automatically updated with the original manuscript, and there may also be improper translations. Readers are advised to use the English manuscript as a reference for more accurate information.
3. All product information provided on the website refer to solutions from manufacturers' technical support or users the contents may have differences in description, and readers are advised to take the original article as the standard.
4. If you have any questions, please contact us at marketing@iczoom.com and mark the subject with "Datasheets" .



DIPPED RADIAL LEAD MULTILAYER CERAMIC CAPACITORS

THD Series

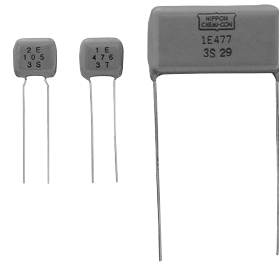

◆FEATURES

1. Small size and large capacitance, high ripple current.
2. Temperature characteristic is Y5U in EIA code.
3. Superior humidity characteristic and long life.
4. Excellent noise absorption.
5. Resin(UL94 V-0) used for coating.

◆APPLICATIONS

1. Automotive equipments.
2. Smoothing circuit of switching mode AC-DC or DC-DC converter.
3. Noise suppressor for various kinds of equipments.
4. By-pass or decoupling circuits.

◆CONSTRUCTION

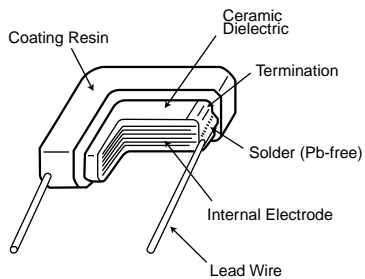

◆RATINGS

1. Category Temperature Range	-55 to +125°C
2. Rated Voltage Range	25, 50, 100, 250 V _{dc}
3. Rated Capacitance Range	0.1 to 470μF
4. Rated Capacitance Tolerance	M(±20%), Z(±20%)
5. Temperature Characteristics	E(JIS) ≒ Y5U(EIA)
6. Rated Ripple Current	See No.5 on the following table

◆SPECIFICATIONS

No.	Items		Specification	Test Condition
1	Withstand Voltage	Between Terminals	No abnormality.	250% of rated voltage shall be applied for 5 seconds.
		Terminals to Coating Resin		
2	Insulation Resistance		1000/C _R (MΩ) or 10000(MΩ) whichever is less.	Rated voltage shall be applied for 60±5 seconds at temperature 20±2°C.
3	Rated Capacitance		Within specified tolerance.	Temperature : 20±2°C Frequency : 1±0.1kHz(≥100μF, 120Hz) Voltage : 1±0.2V _{rms}
4	Dissipation Factor		5.0% maximum.	Temperature : 20±2°C Frequency : 1±0.1kHz(≥100μF, 120Hz) Voltage : 1±0.2V _{rms}

◆SPECIFICATIONS

No.	Items	Specification	Test Condition																		
5	Rated Ripple Current	<table border="1"> <tr> <td>Size code</td> <td>32</td> <td>43</td> <td>55</td> <td>76</td> <td>80</td> <td>90</td> <td>99</td> </tr> <tr> <td>Arms</td> <td>0.3</td> <td>0.8</td> <td>1.0</td> <td>1.5</td> <td>2.0</td> <td>3.0</td> <td>4.0</td> </tr> </table>	Size code	32	43	55	76	80	90	99	Arms	0.3	0.8	1.0	1.5	2.0	3.0	4.0	10kHz to 1MHz (sine curve) Ripple voltage V_p shall be less than the rated voltage.		
Size code	32	43	55	76	80	90	99														
Arms	0.3	0.8	1.0	1.5	2.0	3.0	4.0														
6	Robustness of Terminations	No visible damage.	The force applied shall be : <table border="1"> <tr> <td>Lead ϕ (mm)</td> <td>Tensile(N)</td> <td>(sec.)</td> </tr> <tr> <td>0.5 max.</td> <td>5</td> <td>10±1</td> </tr> <tr> <td>0.6 to 0.8 max.</td> <td>10</td> <td>10±1</td> </tr> </table> <table border="1"> <tr> <td>Lead ϕ (mm)</td> <td>Bending(N)</td> <td>(kg)</td> </tr> <tr> <td>0.5 max.</td> <td>2.5</td> <td>0.25</td> </tr> <tr> <td>0.6 to 0.8 max.</td> <td>5</td> <td>0.51</td> </tr> </table> Time : 2times.	Lead ϕ (mm)	Tensile(N)	(sec.)	0.5 max.	5	10±1	0.6 to 0.8 max.	10	10±1	Lead ϕ (mm)	Bending(N)	(kg)	0.5 max.	2.5	0.25	0.6 to 0.8 max.	5	0.51
Lead ϕ (mm)	Tensile(N)	(sec.)																			
0.5 max.	5	10±1																			
0.6 to 0.8 max.	10	10±1																			
Lead ϕ (mm)	Bending(N)	(kg)																			
0.5 max.	2.5	0.25																			
0.6 to 0.8 max.	5	0.51																			
7	Vibration	Appearance : No abnormality. Capacitance : To meet the initial specification. D.F. : To meet the initial specifications.	Amplitude : 1.5mm Frequency range : 10-55-10Hz (1 min) Direction and time : 2 hours each to X, Y, Z axis. Total 6 hours.																		
8	Solderability	Min. 75% of surface of the termination shall be covered with new solder.	<table border="1"> <tr> <td>Solder</td> <td>Pb Free</td> <td>Eutectic</td> </tr> <tr> <td>Solder Temperature</td> <td>245±5°C</td> <td>235±5°C</td> </tr> <tr> <td>Dipping Time</td> <td colspan="2">2±0.5sec.</td> </tr> </table>	Solder	Pb Free	Eutectic	Solder Temperature	245±5°C	235±5°C	Dipping Time	2±0.5sec.										
Solder	Pb Free	Eutectic																			
Solder Temperature	245±5°C	235±5°C																			
Dipping Time	2±0.5sec.																				
9	Resistance to Soldering Heat	Appearance : No abnormality. $\Delta C/C$: ±15% D.F. : Satisfy the initial spec.	Solder Temperature : 350±10°C Dipping Time : 3±0.5 sec. Depth : 1.5 to 2mm																		
10	Temperature Cycle	Appearance : No abnormality. $\Delta C/C$: ±15% D.F. : To meet the initial specification I.R. : To meet the initial specification	<table border="1"> <tr> <th>Step</th> <th>Temperature (°C)</th> <th>(min.)</th> </tr> <tr> <td>1</td> <td>Min. Category temperature ±3</td> <td>30±3</td> </tr> <tr> <td>2</td> <td>Room temperature</td> <td>3 max.</td> </tr> <tr> <td>3</td> <td>Max. Category temperature ±3</td> <td>30±3</td> </tr> <tr> <td>4</td> <td>Room temperature</td> <td>3 max.</td> </tr> </table> For 5 cycles for above temperature cycle.	Step	Temperature (°C)	(min.)	1	Min. Category temperature ±3	30±3	2	Room temperature	3 max.	3	Max. Category temperature ±3	30±3	4	Room temperature	3 max.			
Step	Temperature (°C)	(min.)																			
1	Min. Category temperature ±3	30±3																			
2	Room temperature	3 max.																			
3	Max. Category temperature ±3	30±3																			
4	Room temperature	3 max.																			
11	Humidity Load Life	Appearance : No abnormality. $\Delta C/C$: ±20% D.F. : 7% maximum I.R. : 50/ C_R (M Ω) or 1000(M Ω) whichever is less.	Temperature : 40±2°C Humidity : 90 to 95%RH Voltage : Rated voltage Time : 500± ²⁴ ₀ hours																		
12	Endurance	Appearance : No abnormality. $\Delta C/C$: ±20% D.F. : 7% maximum I.R. : 100/ C_R (M Ω) or 1000(M Ω) whichever is less.	Temperature : 85±2°C Voltage : 200% of rated voltage. Time : 1000± ⁴⁸ ₀ hours Temperature : 125±3°C Voltage : Rated voltage Time : 1000± ⁴⁸ ₀ hours																		

* C_R : Rated Capacitance(μ F)

◆PART NUMBERING SYSTEM

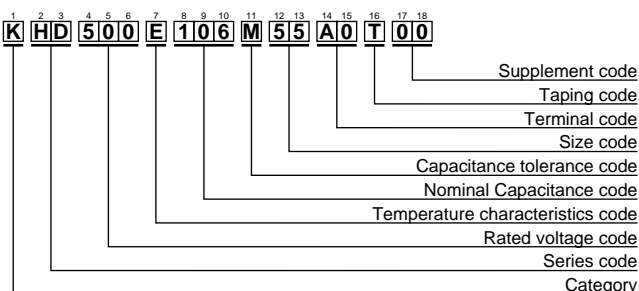

◆DIMENSIONS

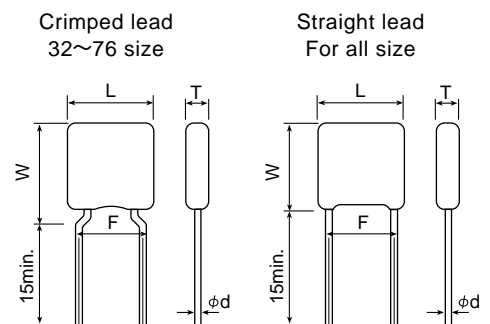



DIPPED RADIAL LEAD MULTILAYER CERAMIC CAPACITORS

THD Series

◆THD SERIES STANDARD RATINGS

Rated voltage (Vdc)	Rated Capacitance (μF)	Dimensions (mm)					Maximum ripple current (Arms)	Part Number	Previous Part Number (Just for your reference)
		Lmax.	Wmax.	Tmax.	F±0.8	φd±0.05			
25	3.3	5.0	6.5	3.0	5.0	0.5	0.3	KHD250E335M32A0T00	THD21E1E335MT
	4.7			3.5				KHD250E475M32A0T00	THD21E1E475MT
	6.8	6.5	7.0	3.5	5.0	0.5	0.8	KHD250E685M43A0T00	THD30E1E685MT
	10			4.0				KHD250E106M43A0T00	THD30E1E106MT
	15			4.0				KHD250E156M43A0T00	THD30E1E156MT
	22	7.5	9.0	4.0	5.0	0.5	1.0	KHD250E226M55A0T00	THD31E1E226MT
	33			4.5				KHD250E336M55A0T00	THD31E1E336MT
	47	13.5	15.0	4.5	10.0	0.6	2.0	KHD250E476M76A0T00	THD41E1E476MT
	68			5.0				KHD250E686M80A0B00	THD51E1E686M
	100	22.5	20.0	5.5	20.0	0.8	3.0	KHD250E107M80A0B00	THD51E1E107M
	150			6.0				KHD250E157M90C0B00	THD60E1E157M
	220	28.5	20.0	6.0	25.0	0.8	4.0	KHD250E227M90C0B00	THD60E1E227M
	330			7.5				KHD250E337M99C0B00	THD61E1E337M
	470			7.5				KHD250E477M99C0B00	THD61E1E477M
50	1.0	5.0	6.5	3.0	5.0	0.5	0.3	KHD500E105M32A0T00	THD21E1H105MT
	1.5			3.5				KHD500E155M32A0T00	THD21E1H155MT
	2.2			3.5				KHD500E225M32A0T00	THD21E1H225MT
	3.3	6.5	7.0	4.0	5.0	0.5	0.8	KHD500E335M43A0T00	THD30E1H335MT
	4.7			4.0				KHD500E475M43A0T00	THD30E1H475MT
	6.8	7.5	9.0	4.0	5.0	0.5	1.0	KHD500E685M55A0T00	THD31E1H685MT
	10			4.5				KHD500E106M55A0T00	THD31E1H106MT
	15			4.5				KHD500E156M55A0T00	THD31E1H156MT
	22	10.0	11.5	4.5	10.0	0.6	1.5	KHD500E226M76A0T00	THD41E1H226MT
	33			5.0				KHD500E336M80A0B00	THD51E1H336M
	47	13.5	15.0	5.0	20.0	0.8	3.0	KHD500E476M90C0B00	THD60E1H476M
	68			6.0				KHD500E686M90C0B00	THD60E1H686M
	100	22.5	20.0	6.0	25.0	0.8	4.0	KHD500E107M90C0B00	THD60E1H107M
	150			7.5				KHD500E157M99C0B00	THD61E1H157M
	220			7.5				KHD500E227M99C0B00	THD61E1H227M
	100	0.33	5.0	6.5	3.0	5.0	0.5	0.3	KHD101E334M32A0T00
0.47		3.5			KHD101E474M32A0T00				THD21E2A474MT
0.68		3.5			KHD101E684M32A0T00				THD21E2A684MT
1.0		6.5	7.0	3.5	5.0	0.5	0.8	KHD101E105M43A0T00	THD30E2A105MT
1.5				4.0				KHD101E155M43A0T00	THD30E2A155MT
2.2		7.5	9.0	4.0	5.0	0.5	1.0	KHD101E225M43A0T00	THD30E2A225MT
3.3				4.5				KHD101E335M55A0T00	THD31E2A335MT
4.7				4.5				KHD101E475M55A0T00	THD31E2A475MT
6.8		10.0	11.5	4.5	10.0	0.6	2.0	KHD101E685M76A0T00	THD41E2A685MT
10				5.0				KHD101E106M80A0B00	THD51E2A106M
15		13.5	15.0	5.0	20.0	0.8	3.0	KHD101E156M80A0B00	THD51E2A156M
22				6.0				KHD101E226M90C0B00	THD60E2A226M
33		22.5	20.0	6.0	25.0	0.8	4.0	KHD101E336M90C0B00	THD60E2A336M
47				7.5				KHD101E476M99C0B00	THD61E2A476M
68		28.5	20.0	7.5	25.0	0.8	4.0	KHD101E686M99C0B00	THD61E2A686M
100				7.5				KHD101E107M99C0B00	THD61E2A107M
250	0.1	6.5	7.0	3.5	5.0	0.5	0.8	KHD251E104M43A0T00	THD30E2E104MT
	0.15			4.0				KHD251E154M43A0T00	THD30E2E154MT
	0.22			4.0				KHD251E224M43A0T00	THD30E2E224MT
	0.33			4.0				KHD251E334M43A0T00	THD30E2E334MT
	0.47	7.5	9.0	4.0	5.0	0.5	1.0	KHD251E474M55A0T00	THD31E2E474MT
	0.68			4.5				KHD251E684M55A0T00	THD31E2E684MT
	1.0	10.0	11.5	4.5	10.0	0.6	1.5	KHD251E105M76A0T00	THD41E2E105MT
	1.5			5.0				KHD251E155M76A0T00	THD41E2E155MT
	2.2	13.5	15.0	5.0	20.0	0.8	3.0	KHD251E225M80A0B00	THD51E2E225M
	3.3			6.0				KHD251E335M90C0B00	THD60E2E335M
	4.7	22.5	20.0	6.0	25.0	0.8	4.0	KHD251E475M90C0B00	THD60E2E475M
	6.8			7.5				KHD251E685M99C0B00	THD61E2E685M
	10	28.5	20.0	7.5	25.0	0.8	4.0	KHD251E106M99C0B00	THD61E2E106M
	15			7.5				KHD251E156M99C0B00	THD61E2E156M