

## 阅读申明

- 1.本站收集的数据手册和产品资料都来自互联网，版权归原作者所有。如读者和版权方有任何异议请及时告之，我们将妥善解决。
- 2.本站提供的中文数据手册是英文数据手册的中文翻译，其目的是协助用户阅读，该译文无法自动跟随原稿更新，同时也可能存在翻译上的不当。建议读者以英文原稿为参考以便获得更精准的信息。
- 3.本站提供的产品资料，来自厂商的技术支持或者使用者的心得体会等，其内容可能存在描述上的差异，建议读者做出适当判断。
- 4.如需与我们联系，请发邮件到marketing@iczoom.com，主题请标有“数据手册”字样。

## Read Statement

1. The datasheets and other product information on the site are all from network reference or other public materials, and the copyright belongs to the original author and original published source. If readers and copyright owners have any objections, please contact us and we will deal with it in a timely manner.
2. The Chinese datasheets provided on the website is a Chinese translation of the English datasheets. Its purpose is for reader's learning exchange only and do not involve commercial purposes. The translation cannot be automatically updated with the original manuscript, and there may also be improper translations. Readers are advised to use the English manuscript as a reference for more accurate information.
3. All product information provided on the website refer to solutions from manufacturers' technical support or users the contents may have differences in description, and readers are advised to take the original article as the standard.
4. If you have any questions, please contact us at marketing@iczoom.com and mark the subject with "Datasheets" .

### Ceramic Capacitors (Safety Regulations) For Surface Mounting Types

Discontinued

- Type HC (Sub-Class Y1)
- Type FC (Sub-Class Y2)
- Type BC (Sub-Class Y2)



#### ■ Features

- Resin molded SMD type for flow/reflow soldering (HC) and reflow soldering (FC,BC)
- High reliability
- Safety requirement approved by UL, SEMKO, NEMKO, FIMKO, DEMKO and KTL\* \* KTL: only Type FC

#### ■ Recommended Application

- Interference suppressors circuit and Isolation circuit of IT equipment such as MODEM.
- Interference suppressors circuit of small power supply machinery such as DC-DC converters and power modules.
- Interference suppressors circuit of AC primary side for general electronic equipment.

#### ■ Explanation of Part Numbers

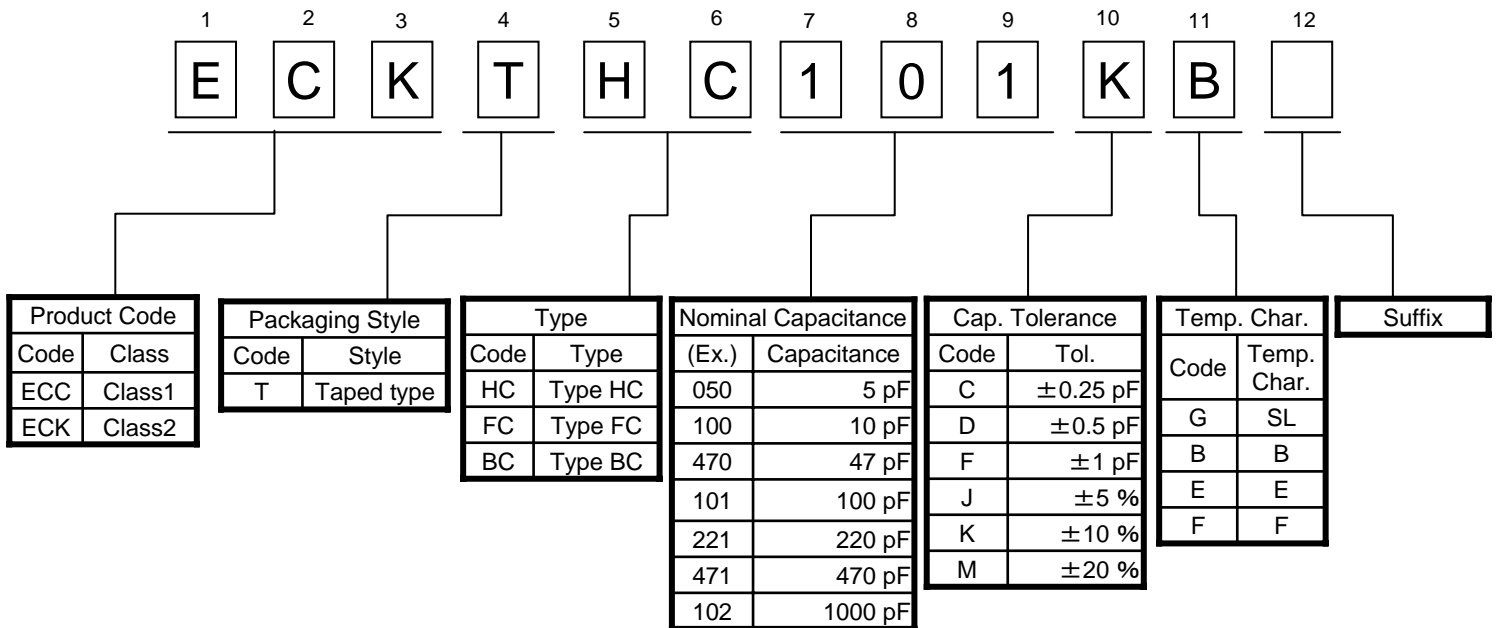

#### ■ Construction

- Type HC

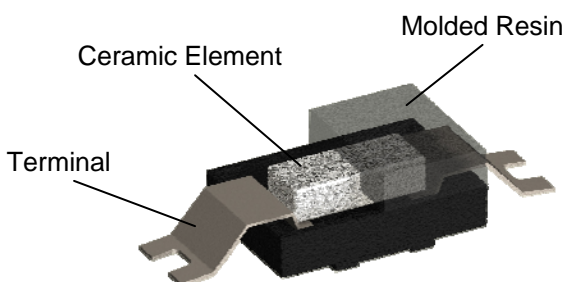

- Type FC,BC

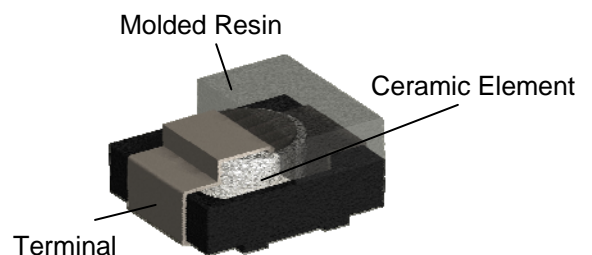

### ■ Dimensions in mm (not to scale) 【Type HC:Y1】

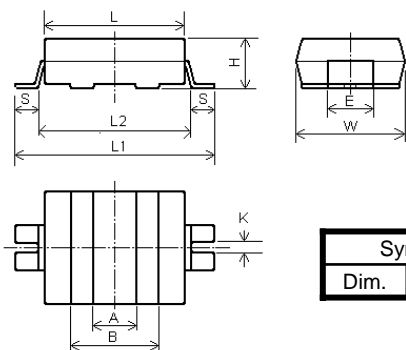

Symbol	L	W	H	S	E	A	B	L1	L2
Dim. Type HC	6.8±0.3	4.5±0.2	2.5 max	1.0±0.50	2.5±0.2	(1.7)	(3.1)	12.0±0.5	8.0 min

### ■ Specifications 【Type HC:Y1】

Characteristics	Temp. Char. B/Y5P		
Operating Temperature Range	-25 to 125 °C		
Rated Voltage	250 VAC		
Dielectric Withstanding Voltage	4000 VAC for 1 minute		
Capacitance	Within the specified tolerance, when measured at 1kHz±20%, 1 to 5 Vrms. and 20 °C		
Q or Dissipation Factor (tan δ)	tan δ < 0.025 at 1 kHz±20 %, 1 to 5 Vrms. and 20 °C		
Insulation Resistance	10000 MΩ min. at 500 VDC and 1 minute electrification		
Temperature Characteristics	Char.	Max. Cap. Change	Temp. Range
	B/Y5P	±10%	-25 ~ 85 °C

### ■ Dimensions in mm (not to scale) 【Type BC,FC:Y2】

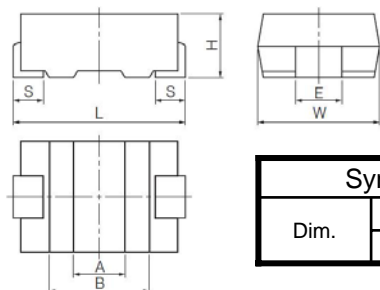

Symbol	L	W	H	S	E	A	B
Dim. Type FC	5.7±0.5	4.5±0.3	2.3 max	0.85±0.30	2.5±0.2	(1.7)	(3.1)
Type BC	7.1±0.5	6.3±0.3	2.5±0.3	1.45±0.30	2.5±0.2	(2.0)	(3.7)

### ■ Specifications 【Type BC,FC:Y2】

Characteristics	Temp. Char. SL/GP	Temp. Char. B/Y5P, E/Y5U, F/Y5V		
Operating Temperature Range	-25 to 100 °C			
Rated Voltage	250 VAC			
Dielectric Withstanding Voltage	1500 VAC for 1 minute			
Capacitance	Within the specified tolerance, when measured at 1 MHz±20 %, 1 to 5 Vrms. and 20 °C	Within the specified tolerance, when measured at 1 kHz±20 %, 1 to 5 Vrms. and 20 °C		
Q or Dissipation Factor (tan δ)	30 pF or under Q > 200+10 C (C:Cap.pF) over 30 pF Q > 500 at 1 MHz±20 %, 1 to 5 Vrms. and 20 °C	tan δ < 0.025 at 1 kHz±20 %, 1 to 5 Vrms. and 20 °C		
Insulation Resistance	10000 MΩ min. at 500 VDC and 1 minute electrification			
Temperature Characteristics	Temperature Coefficient:+350 to -1000 ppm/ °C over the temperature range 20 to 85 °C	Char.	Max. Cap. Change	Temp. Range
		B/Y5P	±10%	-25 ~ 85 °C
		E/Y5U	+20,-55%	
F/Y5V	+30,-80%			

### ■ Related Standards and Certificate Number

Certification Body	Related Standard	Certificate Number			Sub-Class	Rated Voltage	Dielectric Withstanding Voltage	Operating Temperature Range
		Type HC	Type FC	Type BC				
UL(USA)	UL60384-14	E62674	E62674	E62674	HC:Y1 BC/FC:Y2	250 VAC	HC: 4000 VAC BC/FC: 1500 VAC	HC: -25 ~ 125°C BC/FC: -25 ~ 100°C
	CAN/CSA –E60384-14	-----	-----	E62674	Y2		1500 VAC	
SEMKO(Sweden)	EN60384-14 2005	1025027	806189	1025267	HC:Y1 BC/FC:Y2	250 VAC	HC: 4000 VAC BC/FC: 1500 VAC	
FIMKO(Finland)		FI 26683	FI 16588A1 FI 17348A2	FI 26770				
DEMKO(Denmark)		D-00043	310914-01 310698-01	Issuing certification now				
NEMKO(Norway)		P11213874	P01100665 P01101830	P11214054				
KTL(Korea)	K60384-14	-----	SU03013- 3001	-----				

### ■ Ratings and Characteristics

Type Name	Part Number	Capacitance (pF)	Cap. Tolerance	Temp. Char	Dimensions in mm
Type HC	ECKTHC101KB	100	±10 %	B/Y5P	6.8L × 4.5W × 2.5H
	ECKTHC221KB	220			
	ECKTHC471KB	470			
	ECKTHC101MB	100	±20 %		
	ECKTHC221MB	220			
	ECKTHC471MB	470			
Type FC	ECCTFC100DG	10	±0.5 pF	SL/GP	5.7L × 4.5W × 2.3H
	ECCTFC150JG	15	±5 %		
	ECCTFC220JG	22			
	ECCTFC330JG	33	±10 %	B/Y5P	
	ECKTFC470KB	47			
	ECKTFC101KB	100			
	ECKTFC151KB	150			
	ECKTFC221KB	220			
	ECKTFC331KB	330			
	ECKTFC471KB	470	±20 %	E/Y5U	
	ECKTFC102ME	1000		F/Y5V	
	ECKTFC152MF	1500			
	ECKTFC222MF	2200			
Type BC	ECCTBC100DG	10	±0.5 pF	SL/GP	7.1L × 6.3W × 2.5H
	ECCTBC150JG	15	±5 %		
	ECCTBC220JG	22			
	ECCTBC330JG	33			
	ECCTBC470JG	47			
	ECCTBC680JG	68			
	ECKTBC101KB	100		±10 %	
	ECKTBC151KB	150			
	ECKTBC221KB	220			
	ECKTBC331KB	330			
	ECKTBC471KB	470			
	ECKTBC681KB	680			
	ECKTBC102ME	1000	±20 %	E/Y5U	
	ECKTBC152ME	1500			
	ECKTBC222ME	2200			

Notes \* Other capacitance values are available by special order.

### ■ Packaging Methods (Taping)

#### ● Minimum Quantity/Packing Unit

Type	Packaging style	Part Number		Minimum Packing Quantity	Packing Quantity in Carton	Carton Dimensions in mm (LWH)
Type HC	Embossed Carrier Taping	EC□□THC□□□□□	100~470pF	3000 pcs./reel	6000 pcs	350 × 350 × 62
Type FC	Embossed Carrier Taping	EC□□TFC□□□□□	10 to 2200pF	3000 pcs./reel	9000 pcs.	350 × 350 × 62
Type BC	Embossed Carrier Taping	EC□□TBC□□□□□	10 to 2200pF	2000 pcs./reel	6000 pcs.	350 × 350 × 62

#### ● Reel

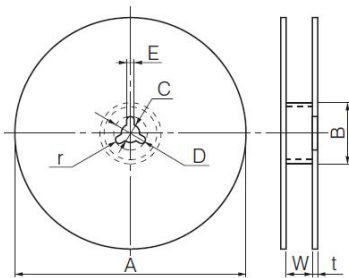

Symbol		A	B	C	D	E	W	t	r
Dim. (mm)	Type HC	330 ±5	60 min	13.0 ±0.5	21.0 ±1.0	2.0 ±0.5	25.5 ±1.5	2.0 ±0.5	R1.0
	Type FC						13.5 ±1.5		
	Type BC								

#### ● Embossed carrier taping

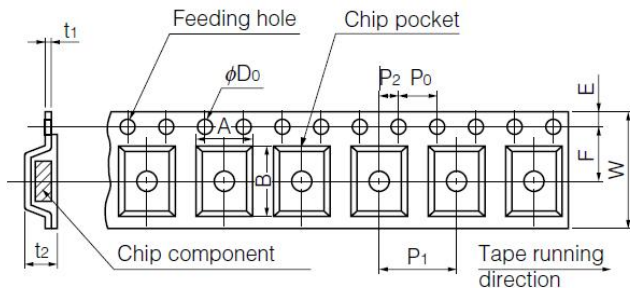

Symbol		A	B	W	F	E	P <sub>1</sub>	P <sub>2</sub>	P <sub>0</sub>	φD <sub>0</sub>	t <sub>1</sub>	t <sub>2</sub>
Dim. (mm)	Type HC	4.8 ±0.2	12.3 ±0.2	24.0 ±0.3	11.5 ±0.1	1.75 ±0.10	8.0 ±0.1	2.00 ±0.05	4.1 ±0.1	1.5 +0.1 -0	0.3 ±0.1	2.8 ±0.3
	Type FC		6.0 ±0.2	12.0 ±0.3	5.5 ±0.1							3.2 ±0.3
	Type BC	6.5 ±0.2	7.5 ±0.2									

#### ● Leader Part and Taped End

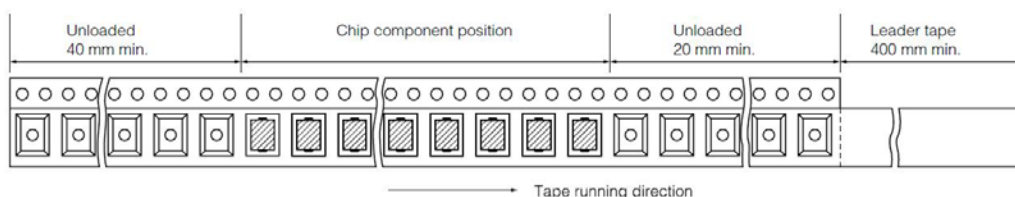

### ■ Typical Characteristics

#### ● Temperature Characteristics

Char. SL/GP  
(Temp.Coeff.: +350 to -1000 ppm/°C)

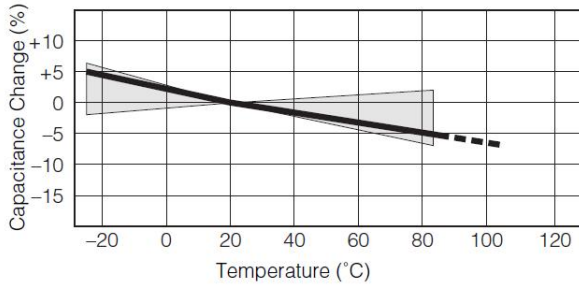

Char. B/Y5P  
Temp.Range: -25 to 85 °C  
Max.Cap.Change: ± 10 %

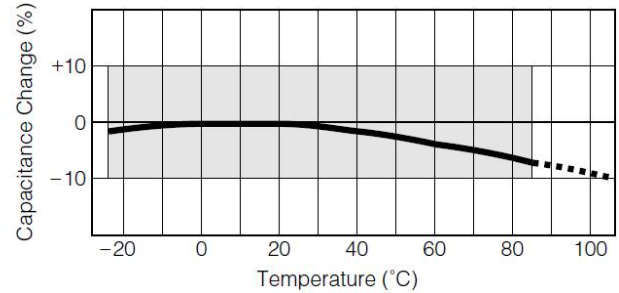

Char. E/Y5U ( Temp.Range: -25 to 85 °C  
max.Cap.Change: +20, -55 % )

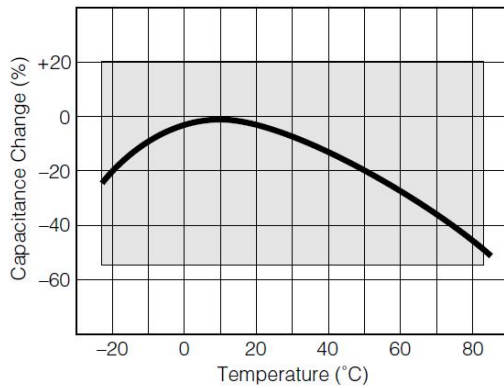

Char. F/Y5V ( Temp. Range : -25 to 85 °C  
max.Cap.Change: +30, -80 % )

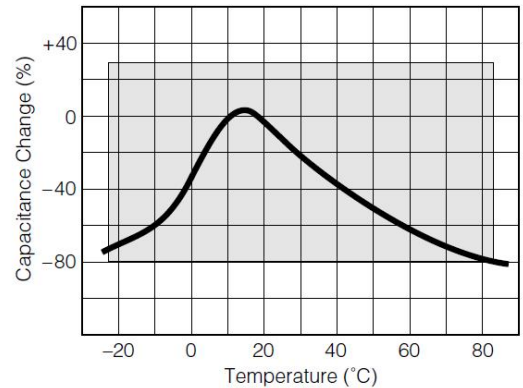

#### ● Impedance vs. Frequency Characteristics

Type FC

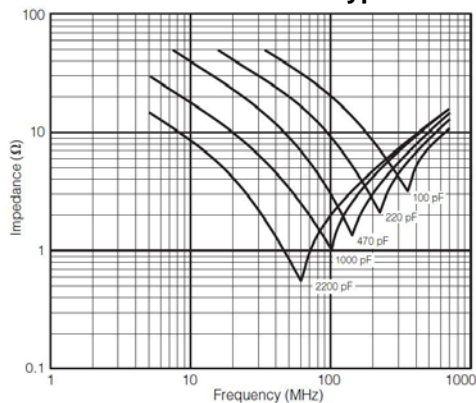

Type BC

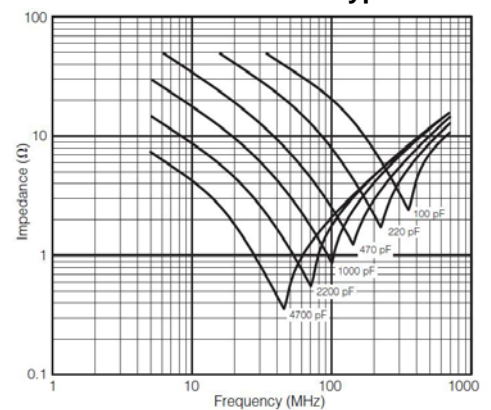

### ■ Typical Characteristics

#### ● Current vs. Voltage (Leakage Current Characteristics)

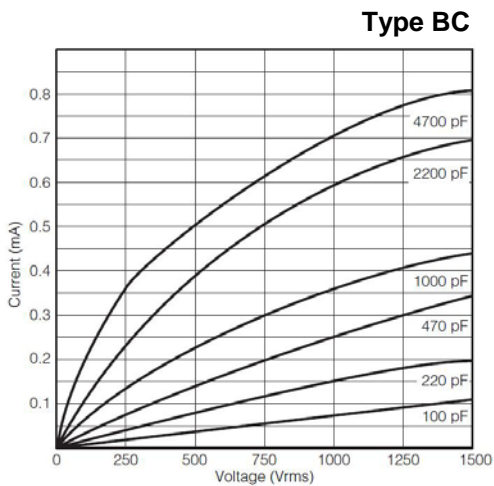
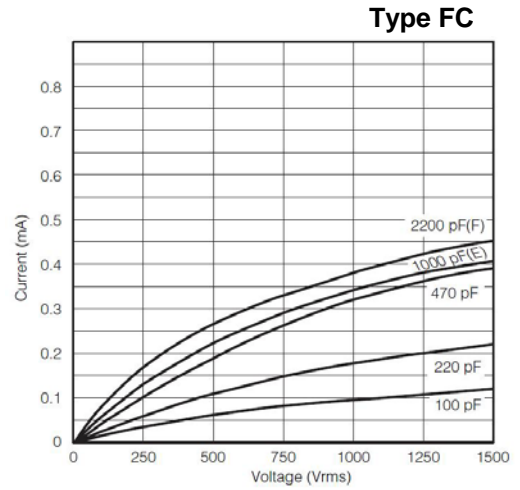
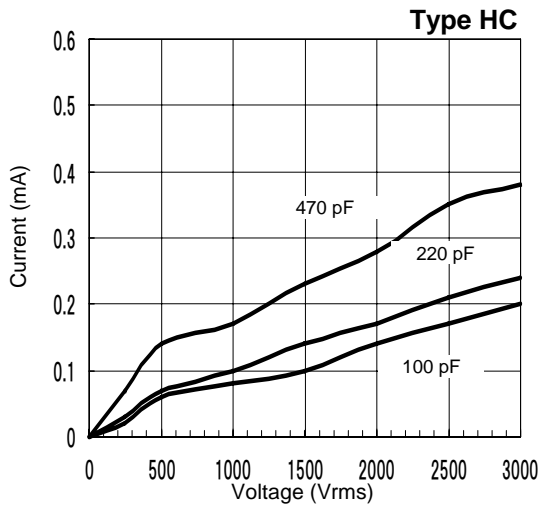

### ■ Application Examples

#### ● MODEM

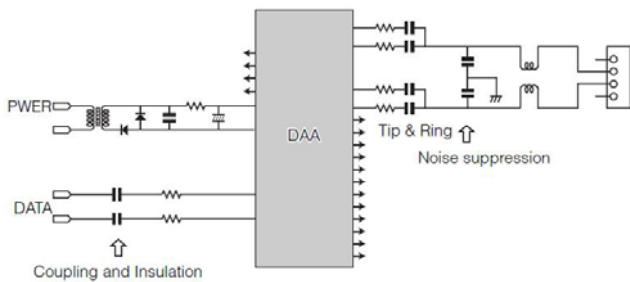

#### ● Primary circuit of Switching Power Supply

