

阅读申明

- 1.本站收集的数据手册和产品资料都来自互联网，版权归原作者所有。如读者和版权方有任何异议请及时告之，我们将妥善解决。
- 2.本站提供的中文数据手册是英文数据手册的中文翻译，其目的是协助用户阅读，该译文无法自动跟随原稿更新，同时也可能存在翻译上的不当。建议读者以英文原稿为参考以便获得更精准的信息。
- 3.本站提供的产品资料，来自厂商的技术支持或者使用者的心得体会等，其内容可能存在描述上的差异，建议读者做出适当判断。
- 4.如需与我们联系，请发邮件到marketing@iczoom.com，主题请标有“数据手册”字样。

Read Statement

1. The datasheets and other product information on the site are all from network reference or other public materials, and the copyright belongs to the original author and original published source. If readers and copyright owners have any objections, please contact us and we will deal with it in a timely manner.
2. The Chinese datasheets provided on the website is a Chinese translation of the English datasheets. Its purpose is for reader's learning exchange only and do not involve commercial purposes. The translation cannot be automatically updated with the original manuscript, and there may also be improper translations. Readers are advised to use the English manuscript as a reference for more accurate information.
3. All product information provided on the website refer to solutions from manufacturers' technical support or users the contents may have differences in description, and readers are advised to take the original article as the standard.
4. If you have any questions, please contact us at marketing@iczoom.com and mark the subject with "Datasheets" .

High Operating Temperature Radial Leaded Multilayer Ceramic Capacitors for Automotive Applications, 50 V_{DC}, 100 V_{DC}, 200 V_{DC}



FEATURES

- AEC-Q200 qualified with PPAP available
- High reliability MLCC insert with wet build process
- High operating temperature up to 175 °C
- High capacitance with small size
- Radial mounting style
- Crimp and straight leadstyles
- Material categorization:
for definitions of compliance please see www.vishay.com/doc?99912



APPLICATIONS

- Automotive applications up to 175 °C

QUICK REFERENCE DATA						
DESCRIPTION	VALUE					
Ceramic Class	1			2		
Ceramic Dielectric	C0G			X0U		
Voltage (V _{DC})	50	100	200	50	100	200
Min. Capacitance (pF)	100	100	100	47 000	47 000	82 000
Max. Capacitance (pF)	12 000	12 000	8200	1 000 000	470 000	180 000
Mounting	Radial					

MARKING

Marking indicates capacitance value and tolerance in accordance with “EIA 198”.

OPERATING TEMPERATURE RANGE

-55 °C to +175 °C (voltage derating above 150 °C)

TEMPERATURE CHARACTERISTICS

Class 1: C0G (± 30 ppm/K within -55 °C to +175 °C)
Class 2: X0U (+22 % / -56 % within -55 °C to +175 °C)

SECTIONAL SPECIFICATIONS

Climatic category (acc. to EN 60058-1)
55/125/21

APPROVALS

EIA 198
IEC 60384-9
AEC-Q200

DESIGN

- The capacitors consist of a high reliability MLCC
- Leads wires are 0.5 mm or 0.6 mm and are made of 100 % tinned copper clad steel wire
- The capacitors may be supplied with straight or kinked leads having a lead spacing of 2.5 mm and 5.0 mm
- Coating is made of flame retardant epoxy resin in accordance with UL 94 V-0

CAPACITANCE RANGE

100 pF to 1 μF

TOLERANCE ON CAPACITANCE

± 5 %, ± 10 %, ± 20 %

RATED VOLTAGE

50 V_{DC}, 100 V_{DC}, 200 V_{DC}

TEST VOLTAGE

- 50 V_{DC} and 100 V_{DC}: 250 % of rated voltage
- 200 V_{DC}: 200 % of rated voltage

INSULATION RESISTANCE

- 50 V_{DC}, 100 V_{DC}: 100 GΩ or 1000 ΩF whichever is less at rated voltage within 2 min of charging
- 200 V_{DC}: 10 GΩ or 100 ΩF whichever is less at rated voltage within 2 min of charging

DISSIPATION FACTOR

Class 1: 0.1 % max.
(C ≤ 1000 pF, at 1 MHz, 1 V; C > 1000 pF, at 1 kHz, 1 V)
Class 2: 2.5 % max. (at 1 kHz, 1 V)

LEAD CONFIGURATION AND DIMENSIONS in millimeters

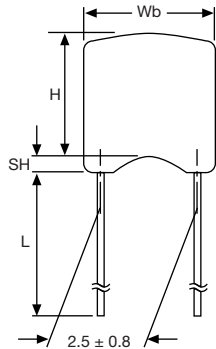

L2

Component outline for lead spacing 2.5 mm ± 0.5 mm (straight leads)

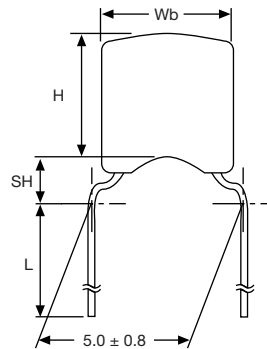

H5

Component outline for lead spacing 5.0 mm ± 0.5 mm (flat bent leads)

SIZE CODE	Wb _{MAX.}	H _{MAX.}	T _{MAX.}	LEAD DIAMETER	MAXIMUM SEATING HEIGHT (SH)	
					L2	H5
15	3.0 - 3.8	2.0 - 3.8	1.6 - 2.6	0.50 ± 0.05	1.6	2.6
20	4.3 - 5.1	2.5 - 5.1	1.9 - 3.2	0.50 ± 0.05	1.6	2.6

Notes

- Bulk packed types have a standard lead length L = 30 mm ± 5 mm.
- L2 and H5 are preferred styles.

MARKING (two sides)

SIZE 15 CAPACITANCE VALUE ≥ 100 pF

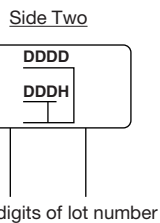
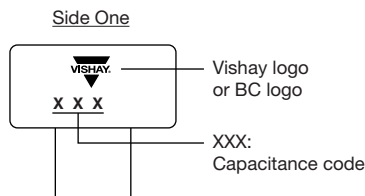

SIZE 20

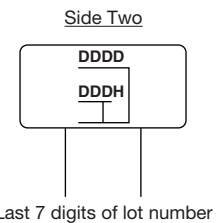
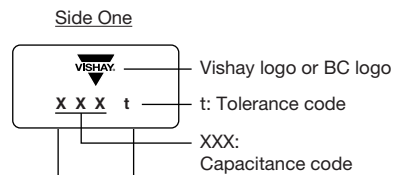

Notes

- Two significant digits followed by one digit for the multiplier: 1 = * 10, 2 = * 100, 3 = * 1000, 4 = * 10 000, 5 = * 100 000.
- The tolerance codes are J = ± 5 %, K = ± 10 %, M = ± 20 %

ORDERING CODE INFORMATION

K	104	K	15	X0U	F	5	3	H	5	H
1	2 3 4	5	6 7	8 9 10	11	12	13	14	15	16
Product Type	Capacitance (pF)	Capacitance Tolerance	Size Code	T.C. Code	Rated Voltage	Lead Diameter	Packaging/Lead Length	Lead Style	Lead Spacing	AEC-Q200 qualified
K = Radial leaded MLCC	The first two digits are the significant figures of capacitance and the last digit is a multiplier as follows: 1 = * 10 2 = * 100 3 = * 1000 4 = * 10 000 5 = * 100 000	J = ± 5 % K = ± 10 % M = ± 20 %	Please refer to relevant datasheet	Please refer to relevant datasheet	F = 50 V _{DC} H = 100 V _{DC} K = 200 V _{DC}	5 = 0.50 mm ± 0.05 mm 6 = 0.60 mm ± 0.05 mm	3 = Bulk T = Tape and reel U = Ammo	H = Flat crimp L = Straight K = Outside crimp	2 = 2.5 mm 5 = 5.0 mm	H = High operating temperature



ORDERING CODES

DIELECTRIC COG			
CAP. (pF)	50 V _{DC}	100 V _{DC}	200 V _{DC}
100	K101#15C0GF5###H	K101#15C0GH5###H	K101#15C0GK5###H
120	K121#15C0GF5###H	K121#15C0GH5###H	K121#15C0GK5###H
150	K151#15C0GF5###H	K151#15C0GH5###H	K151#15C0GK5###H
180	K181#15C0GF5###H	K181#15C0GH5###H	K181#15C0GK5###H
220	K221#15C0GF5###H	K221#15C0GH5###H	K221#15C0GK5###H
270	K271#15C0GF5###H	K271#15C0GH5###H	K271#15C0GK5###H
330	K331#15C0GF5###H	K331#15C0GH5###H	K331#15C0GK5###H
390	K391#15C0GF5###H	K391#15C0GH5###H	K391#15C0GK5###H
470	K471#15C0GF5###H	K471#15C0GH5###H	K471#15C0GK5###H
560	K561#15C0GF5###H	K561#15C0GH5###H	K561#15C0GK5###H
680	K681#15C0GF5###H	K681#15C0GH5###H	K681#15C0GK5###H
820	K821#15C0GF5###H	K821#15C0GH5###H	K821#15C0GK5###H
1000	K102#15C0GF5###H	K102#15C0GH5###H	K102#15C0GK5###H
1200	K122#15C0GF5###H	K122#15C0GH5###H	K122#20C0GK6###H
1500	K152#15C0GF5###H	K152#15C0GH5###H	K152#20C0GK6###H
1800	K182#15C0GF5###H	K182#15C0GH5###H	K182#20C0GK6###H
2200	K222#15C0GF5###H	K222#20C0GH6###H	K222#20C0GK6###H
2700	K272#15C0GF5###H	K272#20C0GH6###H	K272#20C0GK6###H
3300	K332#15C0GF5###H	K332#20C0GH6###H	K332#20C0GK6###H
3900	K392#15C0GF5###H	K392#20C0GH6###H	K392#20C0GK6###H
4700	K472#20C0GF6###H	K472#20C0GH6###H	K472#20C0GK6###H
5600	K562#20C0GF6###H	K562#20C0GH6###H	K562#20C0GK6###H
6800	K682#20C0GF6###H	K682#20C0GH6###H	K682#20C0GK6###H
8200	K822#20C0GF6###H	K822#20C0GH6###H	K822#20C0GK6###H
10 000	K103#20C0GF6###H	K103#20C0GH6###H	/
12 000	K123#20C0GF6###H	K123#20C0GH6###H	/

DIELECTRIC XOU			
CAP. (pF)	50 V _{DC}	100 V _{DC}	200 V _{DC}
47 000	K473#15X0UF5###H	K473#15X0UH5###H	/
56 000	K563#15X0UF5###H	K563#15X0UH5###H	/
68 000	K683#15X0UF5###H	K683#15X0UH5###H	/
82 000	K823#15X0UF5###H	K823#15X0UH5###H	K823#20X0UK6###H
100 000	K104#15X0UF5###H	K104#15X0UH5###H	K104#20X0UK6###H
120 000	K124#15X0UF5###H	K124#20X0UH6###H	K124#20X0UK6###H
150 000	K154#15X0UF5###H	K154#20X0UH6###H	K154#20X0UK6###H
180 000	K184#20X0UF6###H	K184#20X0UH6###H	K184#20X0UK6###H
220 000	K224#20X0UF6###H	K224#20X0UH6###H	/
270 000	K274#20X0UF6###H	K274#20X0UH6###H	/
330 000	K334#20X0UF6###H	K334#20X0UH6###H	/
390 000	K394#20X0UF6###H	K394#20X0UH6###H	/
470 000	K474#20X0UF6###H	K474#20X0UH6###H	/
560 000	K564#20X0UF6###H	/	/
680 000	K684#20X0UF6###H	/	/
820 000	K824#20X0UF6###H	/	/
1 000 000	K105#20X0UF6###H	/	/

Notes

- Lead diameter is 0.5 mm or 0.6 mm
- # 5th digit is capacitance tolerance code: ± 5 % = J; ± 10 % = K; ± 20 % = M
- # 13th digit is packaging code: Bulk = 3; Reel = T; Ammo = U
- # 14th digit is lead style code: L; H; K (L and H are preferred lead configuration)
- # 15th digit is lead spacing code: 2.5 mm = 2; 5.0 mm = 5



RATED VOLTAGE VS. TEMPERATURE (Typical)

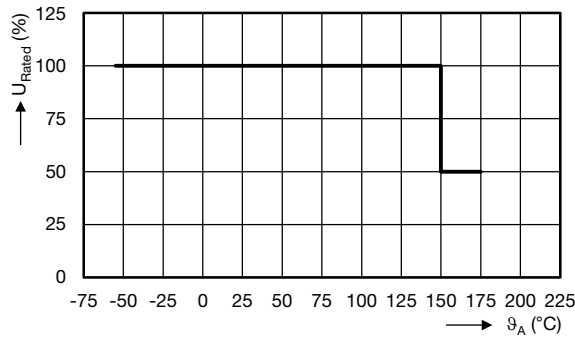

CAPACITANCE CHANGE VS. TEMPERATURE (Typical)

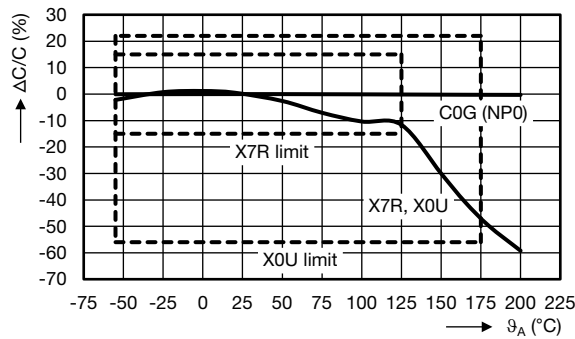

DISSIPATION FACTOR VS. TEMPERATURE (Typical)

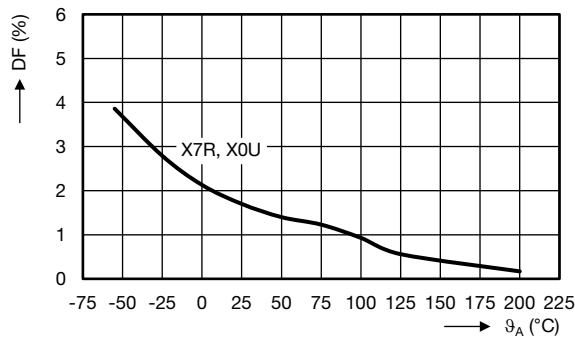

INSULATION RESISTANCE VS. TEMPERATURE (Typical)

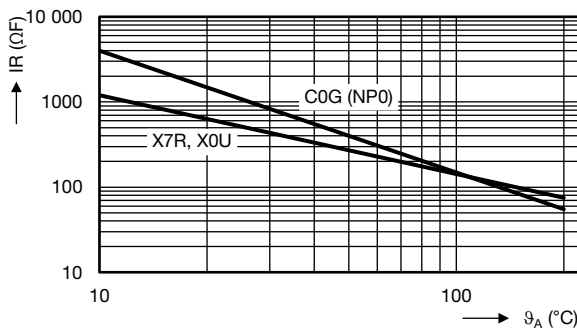

TAPING AND PACKAGING
LABELLING

Each reel is provided with a label showing the following details:

Manufacturer, K style, capacitance, tolerance, batch number, quantity of components, rated voltage, dielectric.

On special request other designations can be shown.

For example:

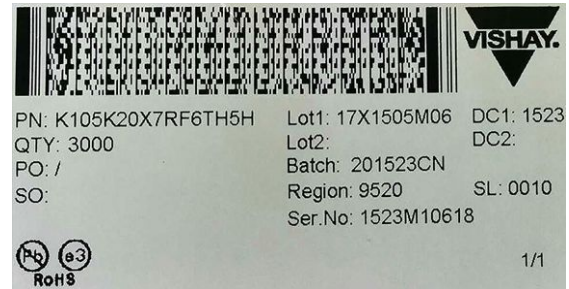

PACKAGING QUANTITIES AND BOX DIMENSIONS			
PACKAGING	SIZE CODE	SMALLEST PACKAGING QUANTITY (SPQ)	BOX DIMENSIONS L x W x H (mm)
Tape on reel	15	4000	370 x 370 x 60
	20	3000	
Ammopack	15, 20	2500	335 x 290 x 50
Bulk ⁽¹⁾	15, 20	5000	245 x 120 x 65

Note

⁽¹⁾ SPQ contains one or a multiple of poly-bags, 1000 units per bag.

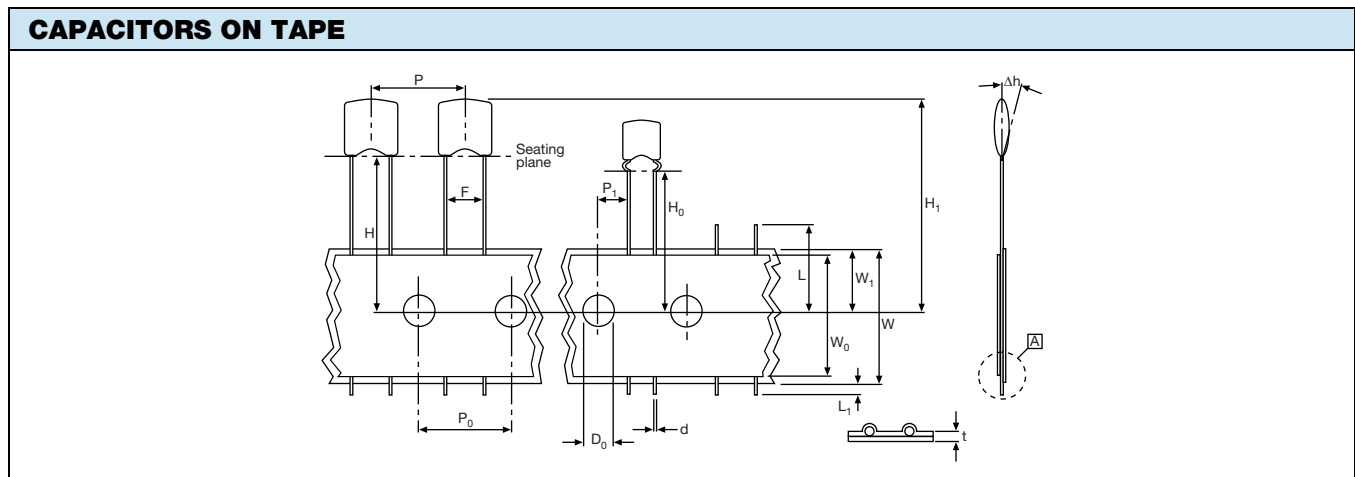

PARAMETER	SYMBOL	DIMENSIONS	
		mm	INCH
Cut-off length	L	≤ 11	≤ 0.443
Lead end protrusion	L ₁	≤ 1	≤ 0.039
Height to seating plane (straight leads)	H	≥ 18	≥ 0.709
Height to seating plane (crimp leads)	H ₀	16.0 ± 0.5	0.630 ± 0.020
Top of component height	H ₁	≤ 32	≤ 1.26
Body inclination	Δh	0 ± 1.0	0 ± 0.039
Carrier tape width	W	18.0 +1.0/-0.5	0.709 +0.039/-0.020
Hold down tape width	W ₀	15.0 REF.	0.591 REF.
Sprocket hole position	W ₁	9.00 +0.075/-0.50	0.354 +0.030/-0.020
Lead space	F	2.50 +0.60/-0.40	0.100 +0.024/-0.016
		5.00 +0.60/-0.40	0.200 +0.024/-0.016
Sprocket hole pitch	P ₀	12.70 ± 0.30	0.500 ± 0.012
Sprocket hole center to lead center at F = 2.5 mm	P ₁	5.08 ± 0.70	0.200 ± 0.028
Sprocket hole center to lead center at F = 5 mm		3.85 ± 0.70	0.150 ± 0.028
Sprocket hole diameter	D ₀	4.0 ± 0.30	0.157 ± 0.012
Overall tape thickness	t	≤ 0.90	≤ 0.035
Wire lead diameter	d	0.50 ± 0.05	0.020 ± 0.002
Taping pitch	P	12.7 REF.	0.50 REF.

REEL DATA

A maximum of 0.5 % of the total number of capacitors per reel may be missing.

A maximum of 1 consecutive vacant positions is followed by 6 consecutive components.

Tape begins and ends with a minimum of 4 empty positions (50 mm tape).

Maximum of 5 splicers per reel.

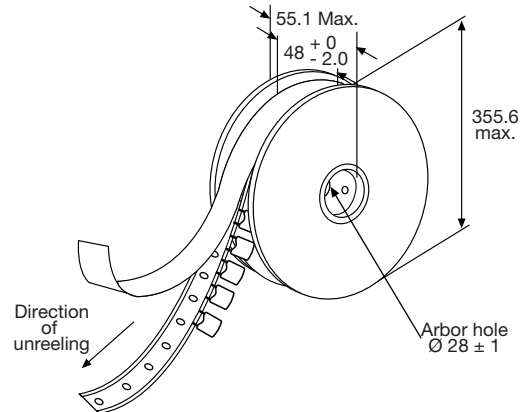
REEL

REEL DIMENSIONS		
REEL SIZE		(mm)
A	Outer diameter	355.6 max.
L	Hole diameter	28 ± 1
K	Core diameter	90
H ₁	Internal width	48 +0/-2
H ₂	External width	55 max.

AMMOPACK DATA

A maximum of 0.5 % of the total number of capacitors per pack may be missing.

A maximum of 1 consecutive vacant positions is followed by 6 consecutive components.

Tape begins and ends with a minimum of 4 empty positions (50 mm tape).

Maximum of 5 splicers per pack.

The cumulative pitch tolerance over 20 consecutive units is not to exceed ± 1.0 mm.

Lead space (F) shall be measured at 3.6 mm ± 0.5 mm from the capacitor seating plane.

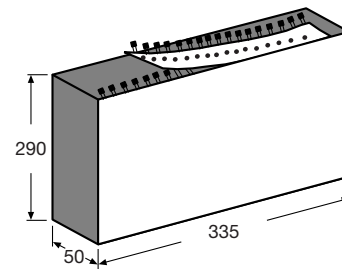
AMMOPACK

RELATED DOCUMENTS	
General Information	www.vishay.com/doc?45214

SAMPLE KIT	
Part Number	HOTC-KIT-KH
Link	www.vishay.com/doc?45234