

阅读申明

- 1.本站收集的数据手册和产品资料都来自互联网，版权归原作者所有。如读者和版权方有任何异议请及时告之，我们将妥善解决。
- 2.本站提供的中文数据手册是英文数据手册的中文翻译，其目的是协助用户阅读，该译文无法自动跟随原稿更新，同时也可能存在翻译上的不当。建议读者以英文原稿为参考以便获得更精准的信息。
- 3.本站提供的产品资料，来自厂商的技术支持或者使用者的心得体会等，其内容可能存在描述上的差异，建议读者做出适当判断。
- 4.如需与我们联系，请发邮件到marketing@iczoom.com，主题请标有“数据手册”字样。

Read Statement

1. The datasheets and other product information on the site are all from network reference or other public materials, and the copyright belongs to the original author and original published source. If readers and copyright owners have any objections, please contact us and we will deal with it in a timely manner.
2. The Chinese datasheets provided on the website is a Chinese translation of the English datasheets. Its purpose is for reader's learning exchange only and do not involve commercial purposes. The translation cannot be automatically updated with the original manuscript, and there may also be improper translations. Readers are advised to use the English manuscript as a reference for more accurate information.
3. All product information provided on the website refer to solutions from manufacturers' technical support or users the contents may have differences in description, and readers are advised to take the original article as the standard.
4. If you have any questions, please contact us at marketing@iczoom.com and mark the subject with "Datasheets" .

High Voltage Ceramic Disc Capacitors (Low loss type)

- Series: **KGE Char. SL/GP, 1 kVDC to 3 kVDC**
- Series: **HT-KB Char. B/Y5P, 500 VDC**
- Series: **KBP Char. B/Y5P, 1 kVDC to 3 kVDC**
- Series: **HT-KC Char. C/Y5S, 500 VDC**
- Series: **KRP Char. R/Y5R 1 kVDC to 3 kVDC**

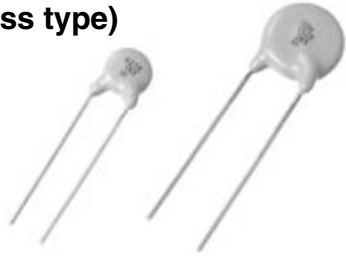

■ Features

- Wide operating temperature: -25 to 105 °C or -25 to 125 °C
- Improved "Voltage vs. Temperature Rise" achieved through low loss ceramic dielectric material.
- Flame-retardant insulating coating applied
- Easy mounting achieved through kinked Lead and Radial Taping

■ Recommended Applications

- Snubber circuit of switching power supply
- Horizontal resonance circuit of TV and CRT display
- Inverter type lighting apparatus
- Ballast circuit of LCD backlighting inverter (For series KGE)
- Others High voltage pulse and DC circuits

■ Explanation of Part Numbers

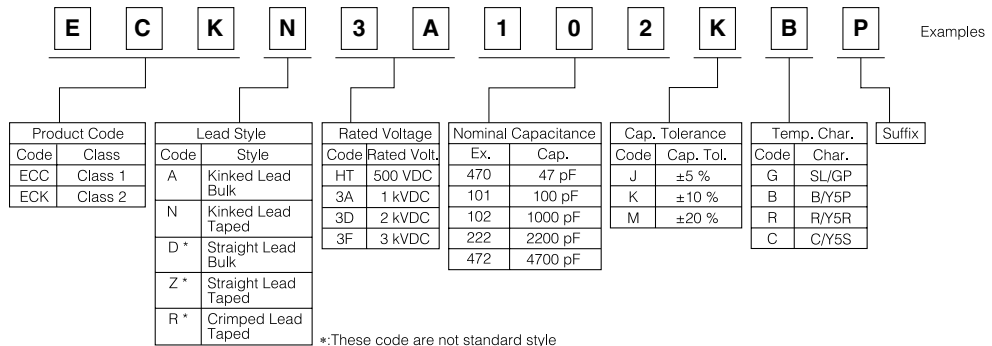

■ Specifications

Characteristic	Series KGE	Series HT-KB, KBP, HT-KC and KRP																				
Operating Temperature Range	-25 to 105 °C	Series HT-KB: -25 to 105 °C Series KBP, HT-KC and KRP: -25 to 125 °C																				
Rated Voltage	1 to 3 kVDC	500 VDC to 3 kVDC																				
Dielectric Withstanding Voltage	200 % of Rated Voltage for 1 to 5 seconds	Rated Voltage 500VDC: 1250 VDC for 1 to 5 seconds Rated Voltage 1 to 3 kVDC: 200 % of Rated Voltage for 1 to 5 seconds																				
Capacitance	Within the specified tolerance, when measured at 1 MHz ± 20 %, 1 to 5 Vrms, and 20 °C	Within the specified tolerance, when measured at 1 kHz ± 20 %, 1 to 5 Vrms, and 20 °C																				
Q or Dissipation Factor (tanδ)	30 pF or under Q ≥ 400+20 C (C:Cap.pF) over 30 pF Q ≥ 1000 at 1 MHz ± 20 %, 1 to 5 Vrms. and 20 °C	Series HT-KB and KBP: tanδ ≥ 0.025 Series HT-KC :tanδ ≥ 0.003 Series KRP :tanδ ≥ 0.002 at 1 kHz ± 20 %, 1 to 5 Vrms. and 20 °C																				
Insulation Resistance	10000 M Ω min. at 500 VDC 1 minute electrification																					
Temperature Characteristics	Temperature Coefficient: +350 to -1000 ppm/°C (Temperature Range: 20 to 85°C)	<table border="1" style="width: 100%; border-collapse: collapse;"> <tr> <th>Series</th> <th>Temp.Char</th> <th>max.Cap.Change</th> <th>Temp. Range</th> </tr> <tr> <td>HT-KB</td> <td>B/Y5P</td> <td>±10 %</td> <td>-25 to 85 °C</td> </tr> <tr> <td>KBP</td> <td>B/Y5P</td> <td>±10 %</td> <td>-25 to 85 °C</td> </tr> <tr> <td>HT-KC</td> <td>C/Y5S</td> <td>±20 %</td> <td>-25 to 85 °C</td> </tr> <tr> <td>KRP</td> <td>R/Y5R</td> <td>±15 %</td> <td>-25 to 85 °C</td> </tr> </table>	Series	Temp.Char	max.Cap.Change	Temp. Range	HT-KB	B/Y5P	±10 %	-25 to 85 °C	KBP	B/Y5P	±10 %	-25 to 85 °C	HT-KC	C/Y5S	±20 %	-25 to 85 °C	KRP	R/Y5R	±15 %	-25 to 85 °C
Series	Temp.Char	max.Cap.Change	Temp. Range																			
HT-KB	B/Y5P	±10 %	-25 to 85 °C																			
KBP	B/Y5P	±10 %	-25 to 85 °C																			
HT-KC	C/Y5S	±20 %	-25 to 85 °C																			
KRP	R/Y5R	±15 %	-25 to 85 °C																			

■ Dimensions in mm (not to scale)

Standard lead style are kinked Lead and Kinked Lead Taping as below.

As usual style as Straight Lead, Straight Lead Taping and Crimped Lead Taping are available on special order.

● Kinked Lead Type

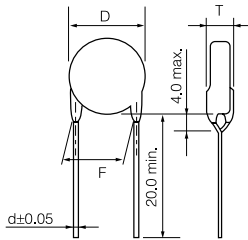

Note: Tolerance of Lead Space

Dim. F (Nominal)	Tolerance of Dim. F
5.0	±1.0
7.5	±1.5
10.0	±1.5

● Straight Lead Type (For reference)

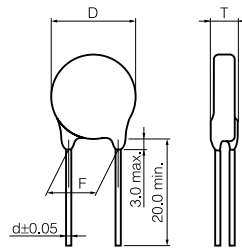

● Kinked Lead Taping

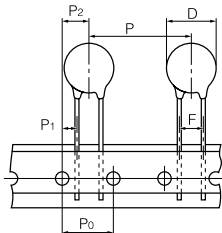
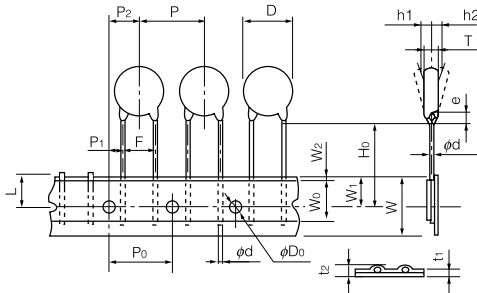

Taping Type	N0	N1	N2
P	12.7±1.0	15.0±2.0	30.0±2.0
P ₀	12.7±0.3	15.0±0.3	15.0±0.3
F	5.0±0.8	7.5±1.0	7.5±1.0
P ₁	3.85±0.70	3.75±0.80	3.75±0.80
P ₂	6.35±1.30	7.5±1.5	7.5±1.5
D	To comply with each individual specification		
W	18.0 ^{+1.0} _{-0.5}		
W ₀	10.0 min.		
W ₁	9.0±0.5		
W ₂	3.0 max.		
H ₀	18.0 ^{+2.0} ₀		
e	4.0 max.		
φD ₀	4.0±0.2		
φd	0.60±0.05	0.65±0.05	
t ₁	0.6±0.3		
t ₂	1.5 max.		
T	To comply with each individual specification		
Δh ₁ , Δh ₂	2.0 max.		
L	11.0 max.		

Same dimensions as Type N0, N1 except for special dimensions.

■ Rated Voltage and Capacitance Range

Series Name	Temp. Char.	Rated Voltage	Capacitance Range in pF				Typical Applications
			10	100	1000	10000	
Series KGE	SL/GP	1 kVDC					Ballast circuit of LCD backlighting inverter
		2 kVDC					
		3 kVDC					
Series HT-KB	B/Y5P	500 VDC					Snubber circuit of switching power supply
Series KBP	B/Y5P	1 kVDC					Horizontal resonance circuit of TV and CRT display
		2 kVDC					
		3 kVDC					
NEW Series HT-KC	C/Y5S	500 VDC					Snubber circuit of switching power supply
NEW Series KRP	R/Y5R	1 kVDC					
		2 kVDC					
		3 kVDC					

■ Dimensions "D" (Body Diameter)

unit : mm

Cap. in pF	KGE			HT-KB	KBP			HT-KC	KRP		
	1 kV	2 kV	3 kV	500 V	1 kV	2 kV	3 kV	500 V	1 kV	2 kV	3 kV
12 to 39	6.0	7.0	7.0								
47	6.0	7.0	7.0								
56	6.0	7.0	8.0								
68	6.0	7.0	8.0								
82	6.0	7.0	9.0								
100	7.0	8.0	10.0	6.0	6.0	7.0	7.5	6.0	6.0	7.0	7.5
120	7.0	8.0	10.0	6.0	6.0	7.0	7.5	6.0	6.0	7.0	7.5
150	8.0	9.0	11.0	6.0	6.0	7.0	7.5	6.0	6.0	7.0	7.5
180	8.0	10.0		6.0	6.0	7.0	7.5	6.0	6.0	7.0	7.5
220	9.0	10.0		6.0	6.0	7.0	7.5	6.0	6.0	7.0	8.0
270	9.0			6.0	6.0	7.0	7.5	6.0	6.0	7.0	8.0
330	11.0			6.0	6.0	7.0	8.0	6.0	6.0	7.5	8.5
390	11.0			6.0	6.0	7.0	9.0	6.0	7.0	7.5	9.5
470	13.0			6.0	6.0	7.5	9.5	6.0	7.0	9.0	9.5
560				6.0	7.0	8.0	10.0	7.0	7.0	9.0	10.5
680				7.0	7.0	9.0	11.0	7.0	7.5	10.0	10.5
820				7.0	7.5	9.0	11.0	7.0	7.5	10.0	12.5
1000				7.0	9.0	10.0	12.5	7.0	9.0	12.0	12.5
1200				8.5	9.0	10.5	14.5	8.5	9.0	12.0	14.5
1500				8.5	9.5	12.0	14.5	8.5	10.5	12.0	14.5
1800				10.0	12.0	12.5	16.0	10.0	10.5	14.0	16.5
2200				10.0	12.0	14.0	17.0	10.0	11.5	16.0	17.0
2700				10.0	13.5	16.0	18.5	11.0	13.0	16.0	
3300				11.0	13.5	17.0		13.0	13.0	19.0	
3900				13.0	15.5	18.0		13.0	14.0	20.0	
4700				13.0	15.5	25.0		14.0	16.5	21.0	
5600					17.0	25.0					

■ Rating and Characteristics

- Series KGE (Class 1, Temp. Char. SL/GP, 1 kVDC to 3 kVDC)

Rated Volt.	Cap. in pF	Capacitance Tolerance (%)	Dimensions in mm		Kinked Lead Type (Bulk)			Kinked Lead Taping Type			
			D max.	T max.	Part Number	Dimensions in mm		Part Number	Taped Type	Dimensions in mm	
						F	d			F	d
1 kVDC	12	±5 or ±10	6.0	5.0	ECCA3A120□GE	5.0	0.60	ECCN3A120□GE	N0	5.0	0.60
	15	±5 or ±10	6.0	5.0	ECCA3A150□GE	5.0	0.60	ECCN3A150□GE	N0	5.0	0.60
	18	±5 or ±10	6.0	5.0	ECCA3A180□GE	5.0	0.60	ECCN3A180□GE	N0	5.0	0.60
	22	±5 or ±10	6.0	5.0	ECCA3A220□GE	5.0	0.60	ECCN3A220□GE	N0	5.0	0.60
	27	±5 or ±10	6.0	5.0	ECCA3A270□GE	5.0	0.60	ECCN3A270□GE	N0	5.0	0.60
	33	±5 or ±10	6.0	5.0	ECCA3A330□GE	5.0	0.60	ECCN3A330□GE	N0	5.0	0.60
	39	±5 or ±10	6.0	5.0	ECCA3A390□GE	5.0	0.60	ECCN3A390□GE	N0	5.0	0.60
	47	±5 or ±10	6.0	5.0	ECCA3A470□GE	5.0	0.60	ECCN3A470□GE	N0	5.0	0.60
	56	±5 or ±10	6.0	5.0	ECCA3A560□GE	5.0	0.60	ECCN3A560□GE	N0	5.0	0.60
	68	±5 or ±10	6.0	5.0	ECCA3A680□GE	5.0	0.60	ECCN3A680□GE	N0	5.0	0.60
	82	±5 or ±10	6.0	5.0	ECCA3A820□GE	5.0	0.60	ECCN3A820□GE	N0	5.0	0.60
	100	±5 or ±10	7.0	5.0	ECCA3A101□GE	5.0	0.60	ECCN3A101□GE	N0	5.0	0.60
	120	±5 or ±10	7.0	5.0	ECCA3A121□GE	5.0	0.60	ECCN3A121□GE	N0	5.0	0.60
	150	±5 or ±10	8.0	5.0	ECCA3A151□GE	5.0	0.60	ECCN3A151□GE	N0	5.0	0.60
	180	±5 or ±10	8.0	5.0	ECCA3A181□GE	5.0	0.60	ECCN3A181□GE	N0	5.0	0.60
	220	±5 or ±10	9.0	5.0	ECCA3A221□GE	5.0	0.60	ECCN3A221□GE	N0	5.0	0.60
	270	±5 or ±10	9.0	5.0	ECCA3A271□GE	5.0	0.60	ECCN3A271□GE	N0	5.0	0.60
	330	±5 or ±10	11.0	5.0	ECCA3A331□GE	5.0	0.60	ECCN3A331□GE	N0	5.0	0.60
390	±5 or ±10	11.0	5.0	ECCA3A391□GE	5.0	0.60	ECCN3A391□GE	N0	5.0	0.60	
470	±5 or ±10	13.0	5.0	ECCA3A471□GE	7.5	0.65	ECCN3A471□GE	N1	7.5	0.65	
2 kVDC	12	±5 or ±10	7.0	5.5	ECCA3D120□GE	7.5	0.65	ECCN3D120□GE	N1	7.5	0.65
	15	±5 or ±10	7.0	5.5	ECCA3D150□GE	7.5	0.65	ECCN3D150□GE	N1	7.5	0.65
	18	±5 or ±10	7.0	5.5	ECCA3D180□GE	7.5	0.65	ECCN3D180□GE	N1	7.5	0.65
	22	±5 or ±10	7.0	5.5	ECCA3D220□GE	7.5	0.65	ECCN3D220□GE	N1	7.5	0.65
	27	±5 or ±10	7.0	5.5	ECCA3D270□GE	7.5	0.65	ECCN3D270□GE	N1	7.5	0.65
	33	±5 or ±10	7.0	5.5	ECCA3D330□GE	7.5	0.65	ECCN3D330□GE	N1	7.5	0.65
	39	±5 or ±10	7.0	5.5	ECCA3D390□GE	7.5	0.65	ECCN3D390□GE	N1	7.5	0.65
	47	±5 or ±10	7.0	5.5	ECCA3D470□GE	7.5	0.65	ECCN3D470□GE	N1	7.5	0.65
	56	±5 or ±10	7.0	5.5	ECCA3D560□GE	7.5	0.65	ECCN3D560□GE	N1	7.5	0.65
	68	±5 or ±10	7.0	5.5	ECCA3D680□GE	7.5	0.65	ECCN3D680□GE	N1	7.5	0.65
	82	±5 or ±10	7.0	5.5	ECCA3D820□GE	7.5	0.65	ECCN3D820□GE	N1	7.5	0.65
	100	±5 or ±10	8.0	5.5	ECCA3D101□GE	7.5	0.65	ECCN3D101□GE	N1	7.5	0.65
120	±5 or ±10	8.0	5.5	ECCA3D121□GE	7.5	0.65	ECCN3D121□GE	N1	7.5	0.65	
150	±5 or ±10	9.0	5.5	ECCA3D151□GE	7.5	0.65	ECCN3D151□GE	N1	7.5	0.65	
180	±5 or ±10	10.0	5.5	ECCA3D181□GE	7.5	0.65	ECCN3D181□GE	N1	7.5	0.65	
220	±5 or ±10	10.0	5.5	ECCA3D221□GE	7.5	0.65	ECCN3D221□GE	N1	7.5	0.65	
3 kVDC	12	±5 or ±10	7.0	6.0	ECCA3F120□GE	7.5	0.65	ECCN3F120□GE	N1	7.5	0.65
	15	±5 or ±10	7.0	6.0	ECCA3F150□GE	7.5	0.65	ECCN3F150□GE	N1	7.5	0.65
	18	±5 or ±10	7.0	6.0	ECCA3F180□GE	7.5	0.65	ECCN3F180□GE	N1	7.5	0.65
	22	±5 or ±10	7.0	6.0	ECCA3F220□GE	7.5	0.65	ECCN3F220□GE	N1	7.5	0.65
	27	±5 or ±10	7.0	6.0	ECCA3F270□GE	7.5	0.65	ECCN3F270□GE	N1	7.5	0.65
	33	±5 or ±10	7.0	6.0	ECCA3F330□GE	7.5	0.65	ECCN3F330□GE	N1	7.5	0.65
	39	±5 or ±10	7.0	6.0	ECCA3F390□GE	7.5	0.65	ECCN3F390□GE	N1	7.5	0.65
	47	±5 or ±10	7.0	6.0	ECCA3F470□GE	7.5	0.65	ECCN3F470□GE	N1	7.5	0.65
	56	±5 or ±10	8.0	6.0	ECCA3F560□GE	7.5	0.65	ECCN3F560□GE	N1	7.5	0.65
	68	±5 or ±10	8.0	6.0	ECCA3F680□GE	7.5	0.65	ECCN3F680□GE	N1	7.5	0.65
	82	±5 or ±10	9.0	6.0	ECCA3F820□GE	7.5	0.65	ECCN3F820□GE	N1	7.5	0.65
	100	±5 or ±10	10.0	6.0	ECCA3F101□GE	7.5	0.65	ECCN3F101□GE	N1	7.5	0.65
	120	±5 or ±10	10.0	6.0	ECCA3F121□GE	7.5	0.65	ECCN3F121□GE	N1	7.5	0.65
	150	±5 or ±10	11.0	6.0	ECCA3F151□GE	7.5	0.65	ECCN3F151□GE	N1	7.5	0.65

Note: Lead spacing (Dim. F) of 5.0 mm is available for rated voltage 2 kVDC and 3 kVDC capacitors that are 11.0 mm or less in the body diameter (Dim. D) on special order.

■ Rating and Characteristics

- Series HT-KB (Class 2, Temp. Char. B/Y5P, 500 VDC)

Rated Volt.	Cap. in pF	Cap. Tol. (%)	Dimensions in mm		Kinked Lead Type (Bulk)			Kinked Lead Taping Type			
			D max.	T max.	Part Number	Dimensions in mm		Part Number	Taped Type	Dimensions in mm	
						F	d			F	d
500 VDC	100	±10	6.0	4.0	ECKAHT101KB	5.0	0.60	ECKNHT101KB	N0	5.0	0.60
	120	±10	6.0	4.0	ECKAHT121KB	5.0	0.60	ECKNHT121KB	N0	5.0	0.60
	150	±10	6.0	4.0	ECKAHT151KB	5.0	0.60	ECKNHT151KB	N0	5.0	0.60
	180	±10	6.0	4.0	ECKAHT181KB	5.0	0.60	ECKNHT181KB	N0	5.0	0.60
	220	±10	6.0	4.0	ECKAHT221KB	5.0	0.60	ECKNHT221KB	N0	5.0	0.60
	270	±10	6.0	4.0	ECKAHT271KB	5.0	0.60	ECKNHT271KB	N0	5.0	0.60
	330	±10	6.0	4.0	ECKAHT331KB	5.0	0.60	ECKNHT331KB	N0	5.0	0.60
	390	±10	6.0	4.0	ECKAHT391KB	5.0	0.60	ECKNHT391KB	N0	5.0	0.60
	470	±10	6.0	4.0	ECKAHT471KB	5.0	0.60	ECKNHT471KB	N0	5.0	0.60
	560	±10	6.0	4.0	ECKAHT561KB	5.0	0.60	ECKNHT561KB	N0	5.0	0.60
	680	±10	7.0	4.0	ECKAHT681KB	5.0	0.60	ECKNHT681KB	N0	5.0	0.60
	820	±10	7.0	4.0	ECKAHT821KB	5.0	0.60	ECKNHT821KB	N0	5.0	0.60
	1000	±10	7.0	4.0	ECKAHT102KB	5.0	0.60	ECKNHT102KB	N0	5.0	0.60
	1200	±10	8.5	4.0	ECKAHT122KB	5.0	0.60	ECKNHT122KB	N0	5.0	0.60
	1500	±10	8.5	4.0	ECKAHT152KB	5.0	0.60	ECKNHT152KB	N0	5.0	0.60
	1800	±10	10.0	4.0	ECKAHT182KB	5.0	0.60	ECKNHT182KB	N0	5.0	0.60
	2200	±10	10.0	4.0	ECKAHT222KB	5.0	0.60	ECKNHT222KB	N0	5.0	0.60
	2700	±10	10.0	4.0	ECKAHT272KB	5.0	0.60	ECKNHT272KB	N0	5.0	0.60
	3300	±10	11.0	4.0	ECKAHT332KB	5.0	0.60	ECKNHT332KB	N0	5.0	0.60
	3900	±10	13.0	4.0	ECKAHT392KB	10.0	0.65	ECKNHT392KB	N1	7.5	0.65
4700	±10	13.0	4.0	ECKAHT472KB	10.0	0.65	ECKNHT472KB	N1	7.5	0.65	

- Series KBP (Class 2, Temp. Char. B/Y5P, 1 to 3 kVDC)

Rated Volt.	Cap. in pF	Cap. Tol. (%)	Dimensions in mm		Kinked Lead Type (Bulk)			Kinked Lead Taping Type			
			D max.	T max.	Part Number	Dimensions in mm		Part Number	Taped Type	Dimensions in mm	
						F	d			F	d
1 kVDC	100	±10	6.0	4.5	ECKA3A101KBP	5.0	0.60	ECKN3A101KBP	N0	5.0	0.60
	120	±10	6.0	4.5	ECKA3A121KBP	5.0	0.60	ECKN3A121KBP	N0	5.0	0.60
	150	±10	6.0	4.5	ECKA3A151KBP	5.0	0.60	ECKN3A151KBP	N0	5.0	0.60
	180	±10	6.0	4.5	ECKA3A181KBP	5.0	0.60	ECKN3A181KBP	N0	5.0	0.60
	220	±10	6.0	4.5	ECKA3A221KBP	5.0	0.60	ECKN3A221KBP	N0	5.0	0.60
	270	±10	6.0	4.5	ECKA3A271KBP	5.0	0.60	ECKN3A271KBP	N0	5.0	0.60
	330	±10	6.0	4.5	ECKA3A331KBP	5.0	0.60	ECKN3A331KBP	N0	5.0	0.60
	390	±10	6.0	4.5	ECKA3A391KBP	5.0	0.60	ECKN3A391KBP	N0	5.0	0.60
	470	±10	6.0	4.5	ECKA3A471KBP	5.0	0.60	ECKN3A471KBP	N0	5.0	0.60
	560	±10	7.0	4.5	ECKA3A561KBP	5.0	0.60	ECKN3A561KBP	N0	5.0	0.60
	680	±10	7.0	4.5	ECKA3A681KBP	5.0	0.60	ECKN3A681KBP	N0	5.0	0.60
	820	±10	7.5	4.5	ECKA3A821KBP	5.0	0.60	ECKN3A821KBP	N0	5.0	0.60
	1000	±10	9.0	4.5	ECKA3A102KBP	5.0	0.60	ECKN3A102KBP	N0	5.0	0.60
	1200	±10	9.0	4.5	ECKA3A122KBP	5.0	0.60	ECKN3A122KBP	N0	5.0	0.60
	1500	±10	9.5	4.5	ECKA3A152KBP	5.0	0.60	ECKN3A152KBP	N0	5.0	0.60
	1800	±10	10.0	4.5	ECKA3A182KBP	5.0	0.60	ECKN3A182KBP	N0	5.0	0.60
	2200	±10	12.0	4.5	ECKA3A222KBP	5.0	0.60	ECKN3A222KBP	N0	5.0	0.60
	2700	±10	12.0	4.5	ECKA3A272KBP	5.0	0.60	ECKN3A272KBP	N0	5.0	0.60
	3300	±10	13.5	4.5	ECKA3A332KBP	10.0	0.65	ECKN3A332KBP	N1	7.5	0.65
	3900	±10	13.5	4.5	ECKA3A392KBP	10.0	0.65	ECKN3A392KBP	N1	7.5	0.65
4700	±10	15.5	4.5	ECKA3A472KBP	10.0	0.65	ECKN3A472KBP	N2	7.5	0.65	
5600	±10	17.0	4.5	ECKA3A562KBP	10.0	0.65	ECKN3A562KBP	N2	7.5	0.65	

■ Rating and Characteristics

● Series KBP (Class 2, Temp. Char. B/Y5P, 1 to 3 kVDC) (Continuation)

Rated Volt.	Cap. in pF	Cap. Tol. (%)	Dimensions in mm		Kinked Lead Type (Bulk)			Kinked Lead Taping Type			
			D max.	T max.	Part Number	Dimensions in mm		Part Number	Taped Type	Dimensions in mm	
						F	d			F	d
2 kVDC	100	±10	7.0	5.0	ECKA3D101KBP	7.5	0.65	ECKN3D101KBP	N1	7.5	0.65
	120	±10	7.0	5.0	ECKA3D121KBP	7.5	0.65	ECKN3D121KBP	N1	7.5	0.65
	150	±10	7.0	5.0	ECKA3D151KBP	7.5	0.65	ECKN3D151KBP	N1	7.5	0.65
	180	±10	7.0	5.0	ECKA3D181KBP	7.5	0.65	ECKN3D181KBP	N1	7.5	0.65
	220	±10	7.0	5.0	ECKA3D221KBP	7.5	0.65	ECKN3D221KBP	N1	7.5	0.65
	270	±10	7.0	5.0	ECKA3D271KBP	7.5	0.65	ECKN3D271KBP	N1	7.5	0.65
	330	±10	7.0	5.0	ECKA3D331KBP	7.5	0.65	ECKN3D331KBP	N1	7.5	0.65
	390	±10	7.0	5.0	ECKA3D391KBP	7.5	0.65	ECKN3D391KBP	N1	7.5	0.65
	470	±10	7.5	5.0	ECKA3D471KBP	7.5	0.65	ECKN3D471KBP	N1	7.5	0.65
	560	±10	8.0	5.0	ECKA3D561KBP	7.5	0.65	ECKN3D561KBP	N1	7.5	0.65
	680	±10	9.0	5.0	ECKA3D681KBP	7.5	0.65	ECKN3D681KBP	N1	7.5	0.65
	820	±10	9.0	5.0	ECKA3D821KBP	7.5	0.65	ECKN3D821KBP	N1	7.5	0.65
	1000	±10	10.0	5.0	ECKA3D102KBP	7.5	0.65	ECKN3D102KBP	N1	7.5	0.65
	1200	±10	10.5	5.0	ECKA3D122KBP	7.5	0.65	ECKN3D122KBP	N1	7.5	0.65
	1500	±10	12.0	5.0	ECKA3D152KBP	7.5	0.65	ECKN3D152KBP	N1	7.5	0.65
	1800	±10	12.5	5.0	ECKA3D182KBP	7.5	0.65	ECKN3D182KBP	N1	7.5	0.65
	2200	±10	14.0	5.0	ECKA3D222KBP	10.0	0.65	ECKN3D222KBP	N2	7.5	0.65
	2700	±10	16.0	5.0	ECKA3D272KBP	10.0	0.65	ECKN3D272KBP	N2	7.5	0.65
	3300	±10	17.0	5.0	ECKA3D332KBP	10.0	0.65	ECKN3D332KBP	N2	7.5	0.65
	3900	±10	18.0	5.0	ECKA3D392KBP	10.0	0.65	ECKN3D392KBP	N2	7.5	0.65
4700	±10	25.0	5.0	ECKA3D472KBP	10.0	0.65	—	—	—	—	
5600	±10	25.0	5.0	ECKA3D562KBP	10.0	0.65	—	—	—	—	
3 kVDC	100	±10	7.5	6.0	ECKA3F101KBP	7.5	0.65	ECKN3F101KBP	N1	7.5	0.65
	120	±10	7.5	6.0	ECKA3F121KBP	7.5	0.65	ECKN3F121KBP	N1	7.5	0.65
	150	±10	7.5	6.0	ECKA3F151KBP	7.5	0.65	ECKN3F151KBP	N1	7.5	0.65
	180	±10	7.5	6.0	ECKA3F181KBP	7.5	0.65	ECKN3F181KBP	N1	7.5	0.65
	220	±10	7.5	6.0	ECKA3F221KBP	7.5	0.65	ECKN3F221KBP	N1	7.5	0.65
	270	±10	7.5	6.0	ECKA3F271KBP	7.5	0.65	ECKN3F271KBP	N1	7.5	0.65
	330	±10	8.0	6.0	ECKA3F331KBP	7.5	0.65	ECKN3F331KBP	N1	7.5	0.65
	390	±10	9.0	6.0	ECKA3F391KBP	7.5	0.65	ECKN3F391KBP	N1	7.5	0.65
	470	±10	9.5	6.0	ECKA3F471KBP	7.5	0.65	ECKN3F471KBP	N1	7.5	0.65
	560	±10	10.0	6.0	ECKA3F561KBP	7.5	0.65	ECKN3F561KBP	N1	7.5	0.65
	680	±10	11.0	6.0	ECKA3F681KBP	7.5	0.65	ECKN3F681KBP	N1	7.5	0.65
	820	±10	11.0	6.0	ECKA3F821KBP	7.5	0.65	ECKN3F821KBP	N1	7.5	0.65
	1000	±10	12.5	6.0	ECKA3F102KBP	7.5	0.65	ECKN3F102KBP	N1	7.5	0.65
	1200	±10	14.5	6.0	ECKA3F122KBP	10.0	0.65	ECKN3F122KBP	N1	7.5	0.65
	1500	±10	14.5	6.0	ECKA3F152KBP	10.0	0.65	ECKN3F152KBP	N1	7.5	0.65
	1800	±10	16.0	6.0	ECKA3F182KBP	10.0	0.65	ECKN3F182KBP	N2	7.5	0.65
	2200	±10	17.0	6.0	ECKA3F222KBP	10.0	0.65	ECKN3F222KBP	N2	7.5	0.65
2700	±10	18.5	6.0	ECKA3F272KBP	10.0	0.65	ECKN3F272KBP	N2	7.5	0.65	

Note: Lead spacing (Dim. F) of 5.0 mm is available for rated voltage 2 kVDC and 3 kVDC capacitors that are 11.0 mm or less in the body diameter (Dim. D) on special order.

Rating and Characteristics

NEW

● Series HT-KC (Class 2, Temp. Char. C/Y5S, 500 VDC)

Rated Volt.	Cap. in pF	Cap. Tol. (%)	Dimensions in mm		Kinked Lead Type (Bulk)			Kinked Lead Taping Type			
			D max.	T max.	Part Number	Dimensions in mm		Part Number	Taped Type	Dimensions in mm	
						F	d			F	d
500 VDC	100	±10	6.0	4.0	ECKAHT101KC	5.0	0.60	ECKNHT101KC	N0	5.0	0.60
	120	±10	6.0	4.0	ECKAHT121KC	5.0	0.60	ECKNHT121KC	N0	5.0	0.60
	150	±10	6.0	4.0	ECKAHT151KC	5.0	0.60	ECKNHT151KC	N0	5.0	0.60
	180	±10	6.0	4.0	ECKAHT181KC	5.0	0.60	ECKNHT181KC	N0	5.0	0.60
	220	±10	6.0	4.0	ECKAHT221KC	5.0	0.60	ECKNHT221KC	N0	5.0	0.60
	270	±10	6.0	4.0	ECKAHT271KC	5.0	0.60	ECKNHT271KC	N0	5.0	0.60
	330	±10	6.0	4.0	ECKAHT331KC	5.0	0.60	ECKNHT331KC	N0	5.0	0.60
	390	±10	6.0	4.0	ECKAHT391KC	5.0	0.60	ECKNHT391KC	N0	5.0	0.60
	470	±10	6.0	4.0	ECKAHT471KC	5.0	0.60	ECKNHT471KC	N0	5.0	0.60
	560	±10	7.0	4.0	ECKAHT561KC	5.0	0.60	ECKNHT561KC	N0	5.0	0.60
	680	±10	7.0	4.0	ECKAHT681KC	5.0	0.60	ECKNHT681KC	N0	5.0	0.60
	820	±10	7.0	4.0	ECKAHT821KC	5.0	0.60	ECKNHT821KC	N0	5.0	0.60
	1000	±10	7.0	4.0	ECKAHT102KC	5.0	0.60	ECKNHT102KC	N0	5.0	0.60
	1200	±10	8.5	4.0	ECKAHT122KC	5.0	0.60	ECKNHT122KC	N0	5.0	0.60
	1500	±10	8.5	4.0	ECKAHT152KC	5.0	0.60	ECKNHT152KC	N0	5.0	0.60
	1800	±10	10.0	4.0	ECKAHT182KC	5.0	0.60	ECKNHT182KC	N0	5.0	0.60
	2200	±10	10.0	4.0	ECKAHT222KC	5.0	0.60	ECKNHT222KC	N0	5.0	0.60
	2700	±10	11.0	4.0	ECKAHT272KC	5.0	0.60	ECKNHT272KC	N0	5.0	0.60
3300	±10	13.0	4.0	ECKAHT332KC	7.5	0.65	ECKNHT332KC	N1	7.5	0.65	
3900	±10	13.0	4.0	ECKAHT392KC	7.5	0.65	ECKNHT392KC	N1	7.5	0.65	
4700	±10	14.0	4.0	ECKAHT472KC	7.5	0.65	ECKNHT472KC	N1	7.5	0.65	

NEW

● Series KRP (Class 2, Temp. Char. R/Y5R, 1 to 3 kVDC)

Rated Volt.	Cap. in pF	Cap. Tol. (%)	Dimensions in mm		Kinked Lead Type (Bulk)			Kinked Lead Taping Type			
			D max.	T max.	Part Number	Dimensions in mm		Part Number	Taped Type	Dimensions in mm	
						F	d			F	d
1 kVDC	100	±10	6.0	4.5	ECKA3A101KRP	5.0	0.60	ECKN3A101KRP	N0	5.0	0.60
	120	±10	6.0	4.5	ECKA3A121KRP	5.0	0.60	ECKN3A121KRP	N0	5.0	0.60
	150	±10	6.0	4.5	ECKA3A151KRP	5.0	0.60	ECKN3A151KRP	N0	5.0	0.60
	180	±10	6.0	4.5	ECKA3A181KRP	5.0	0.60	ECKN3A181KRP	N0	5.0	0.60
	220	±10	6.0	4.5	ECKA3A221KRP	5.0	0.60	ECKN3A221KRP	N0	5.0	0.60
	270	±10	6.0	4.5	ECKA3A271KRP	5.0	0.60	ECKN3A271KRP	N0	5.0	0.60
	330	±10	6.0	4.5	ECKA3A331KRP	5.0	0.60	ECKN3A331KRP	N0	5.0	0.60
	390	±10	7.0	4.5	ECKA3A391KRP	5.0	0.60	ECKN3A391KRP	N0	5.0	0.60
	470	±10	7.0	4.5	ECKA3A471KRP	5.0	0.60	ECKN3A471KRP	N0	5.0	0.60
	560	±10	7.0	4.5	ECKA3A561KRP	5.0	0.60	ECKN3A561KRP	N0	5.0	0.60
	680	±10	7.5	4.5	ECKA3A681KRP	5.0	0.60	ECKN3A681KRP	N0	5.0	0.60
	820	±10	7.5	4.5	ECKA3A821KRP	5.0	0.60	ECKN3A821KRP	N0	5.0	0.60
	1000	±10	9.0	4.5	ECKA3A102KRP	5.0	0.60	ECKN3A102KRP	N0	5.0	0.60
	1200	±10	9.0	4.5	ECKA3A122KRP	5.0	0.60	ECKN3A122KRP	N0	5.0	0.60
	1500	±10	10.5	4.5	ECKA3A152KRP	5.0	0.60	ECKN3A152KRP	N0	5.0	0.60
	1800	±10	10.5	4.5	ECKA3A182KRP	5.0	0.60	ECKN3A182KRP	N0	5.0	0.60
	2200	±10	11.5	4.5	ECKA3A222KRP	5.0	0.60	ECKN3A222KRP	N0	5.0	0.60
	2700	±10	13.0	4.5	ECKA3A272KRP	7.5	0.65	ECKN3A272KRP	N1	7.5	0.65
3300	±10	13.0	4.5	ECKA3A332KRP	7.5	0.65	ECKN3A332KRP	N1	7.5	0.65	
3900	±10	14.0	4.5	ECKA3A392KRP	7.5	0.65	ECKN3A392KRP	N1	7.5	0.65	
4700	±10	16.5	4.5	ECKA3A472KRP	7.5	0.65	ECKN3A472KRP	N1	7.5	0.65	

Rating and Characteristics

NEW

● Series KRP (Class 2, Temp. Char. R/Y5R, 1 to 3 kVDC) (Continuation)

Rated Volt.	Cap. in pF	Cap. Tol. (%)	Dimensions in mm		Kinked Lead Type (Bulk)			Kinked Lead Taping Type			
			D max.	T max.	Part Number	Dimensions in mm		Part Number	Taped Type	Dimensions in mm	
						F	d			F	d
2 kVDC	100	±10	7.0	5.0	ECKA3D101KRP	7.5	0.65	ECKN3D101KRP	N1	7.5	0.65
	120	±10	7.0	5.0	ECKA3D121KRP	7.5	0.65	ECKN3D121KRP	N1	7.5	0.65
	150	±10	7.0	5.0	ECKA3D151KRP	7.5	0.65	ECKN3D151KRP	N1	7.5	0.65
	180	±10	7.0	5.0	ECKA3D181KRP	7.5	0.65	ECKN3D181KRP	N1	7.5	0.65
	220	±10	7.0	5.0	ECKA3D221KRP	7.5	0.65	ECKN3D221KRP	N1	7.5	0.65
	270	±10	7.0	5.0	ECKA3D271KRP	7.5	0.65	ECKN3D271KRP	N1	7.5	0.65
	330	±10	7.5	5.0	ECKA3D331KRP	7.5	0.65	ECKN3D331KRP	N1	7.5	0.65
	390	±10	7.5	5.0	ECKA3D391KRP	7.5	0.65	ECKN3D391KRP	N1	7.5	0.65
	470	±10	9.0	5.0	ECKA3D471KRP	7.5	0.65	ECKN3D471KRP	N1	7.5	0.65
	560	±10	9.0	5.0	ECKA3D561KRP	7.5	0.65	ECKN3D561KRP	N1	7.5	0.65
	680	±10	10.0	5.0	ECKA3D681KRP	7.5	0.65	ECKN3D681KRP	N1	7.5	0.65
	820	±10	10.0	5.0	ECKA3D821KRP	7.5	0.65	ECKN3D821KRP	N1	7.5	0.65
	1000	±10	12.0	5.0	ECKA3D102KRP	7.5	0.65	ECKN3D102KRP	N1	7.5	0.65
	1200	±10	12.0	5.0	ECKA3D122KRP	7.5	0.65	ECKN3D122KRP	N1	7.5	0.65
	1500	±10	12.0	5.0	ECKA3D152KRP	7.5	0.65	ECKN3D152KRP	N1	7.5	0.65
	1800	±10	14.0	5.0	ECKA3D182KRP	10.0	0.65	—	—	—	—
	2200	±10	16.0	5.0	ECKA3D222KRP	10.0	0.65	—	—	—	—
	2700	±10	16.0	5.0	ECKA3D272KRP	10.0	0.65	—	—	—	—
	3300	±10	19.0	5.0	ECKA3D332KRP	10.0	0.65	—	—	—	—
	3900	±10	20.0	5.0	ECKA3D392KRP	10.0	0.65	—	—	—	—
4700	±10	21.0	5.0	ECKA3D472KRP	10.0	0.65	—	—	—	—	
3 kVDC	100	±10	7.5	5.5	ECKA3F101KRP	7.5	0.65	ECKN3F101KRP	N1	7.5	0.65
	120	±10	7.5	5.5	ECKA3F121KRP	7.5	0.65	ECKN3F121KRP	N1	7.5	0.65
	150	±10	7.5	5.5	ECKA3F151KRP	7.5	0.65	ECKN3F151KRP	N1	7.5	0.65
	180	±10	7.5	5.5	ECKA3F181KRP	7.5	0.65	ECKN3F181KRP	N1	7.5	0.65
	220	±10	8.0	5.5	ECKA3F221KRP	7.5	0.65	ECKN3F221KRP	N1	7.5	0.65
	270	±10	8.0	5.5	ECKA3F271KRP	7.5	0.65	ECKN3F271KRP	N1	7.5	0.65
	330	±10	8.5	5.5	ECKA3F331KRP	7.5	0.65	ECKN3F331KRP	N1	7.5	0.65
	390	±10	9.5	5.5	ECKA3F391KRP	7.5	0.65	ECKN3F391KRP	N1	7.5	0.65
	470	±10	9.5	5.5	ECKA3F471KRP	7.5	0.65	ECKN3F471KRP	N1	7.5	0.65
	560	±10	10.5	5.5	ECKA3F561KRP	7.5	0.65	ECKN3F561KRP	N1	7.5	0.65
	680	±10	10.5	5.5	ECKA3F681KRP	7.5	0.65	ECKN3F681KRP	N1	7.5	0.65
	820	±10	12.5	5.5	ECKA3F821KRP	7.5	0.65	ECKN3F821KRP	N1	7.5	0.65
	1000	±10	12.5	5.5	ECKA3F102KRP	10.0	0.65	—	—	—	—
	1200	±10	14.5	5.5	ECKA3F122KRP	10.0	0.65	—	—	—	—
	1500	±10	14.5	5.5	ECKA3F152KRP	10.0	0.65	—	—	—	—
	1800	±10	16.5	5.5	ECKA3F182KRP	10.0	0.65	—	—	—	—
2200	±10	17.0	5.5	ECKA3F222KRP	10.0	0.65	—	—	—	—	

Note: Lead spacing (Dim. F) of 5.0 mm is available for rated voltage 2 kVDC and 3 kVDC capacitors that are 10.5 mm or less in the body diameter (Dim. D) on special order.

■ Typical Temperature Characteristics

Series KGE (Char. SL/GP)

(Temp. Coeff. : +350 to -1000 ppm/°C)

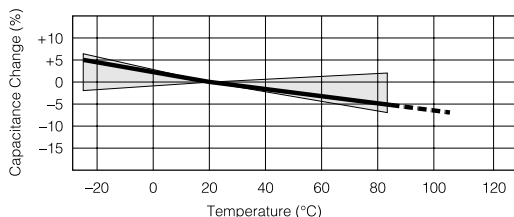

Series HT-KB, KBP (Char. B/Y5P)

(Temp. Range : -25 to 85 °C
max. Cap. Change : ±10 %)

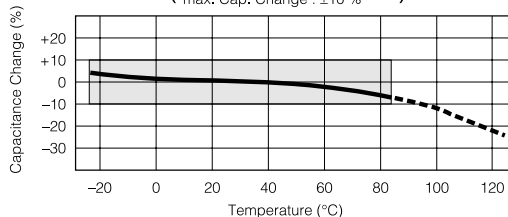

Series HT-KC (Char. C/Y5S)

(Temp. Range : -25 to 85 °C
max. Cap. Change : ±20 %)

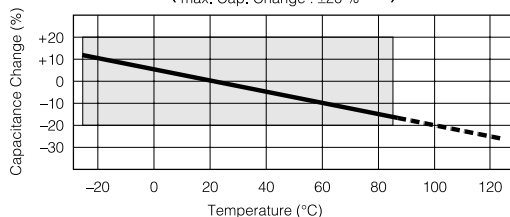

Series KRP (Char. R/Y5R)

(Temp. Range : -25 to 85 °C
max. Cap. Change : ±15 %)

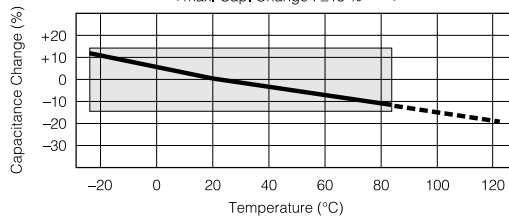

■ Characteristics of Voltage-Frequency

Series HT-KB 500 VDC

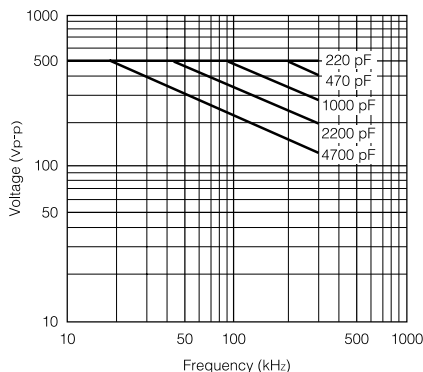

Series HT-KC 500 VDC

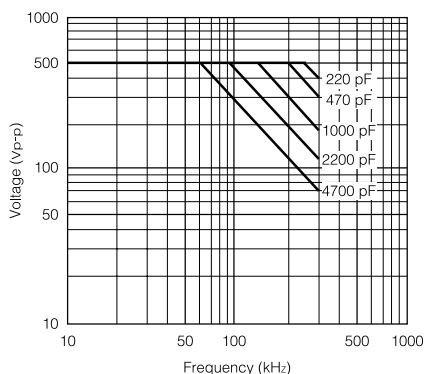

Above-mentioned graph shows the maximum permission voltage when using a capacitor at the AC sine wave voltage. As for this voltage, when measuring in room temperature (25 °C), the capacitor self generation of heat shows the voltage which becomes a maximum of 20 °C.

When using at the pulse voltage or AC voltage except the sine wave, Use on confirming that the capacitor self generation of heat temperature is less than 20 °C in room temperature (ambient temperature is 25 °C)

The self generation of heat temperature (the difference between the surface temperature and the ambient temperature of capacitor) changes according to ambient temperature.

As for the permission self generation of heat temperature when the ambient temperature is more than 25 °C, refer to the figure of the next page.

■ Characteristics of Voltage – Frequency (Continuation)

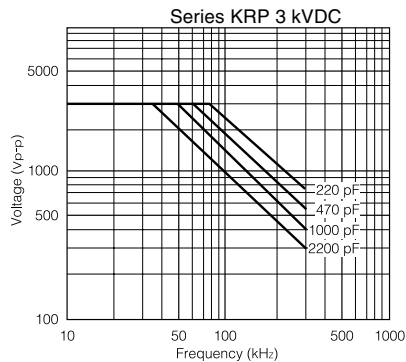
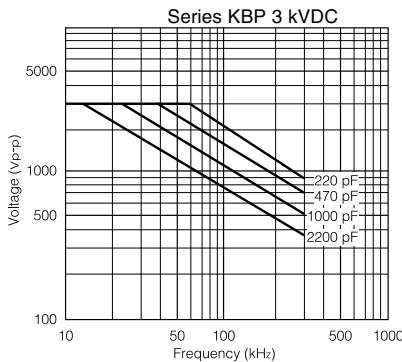
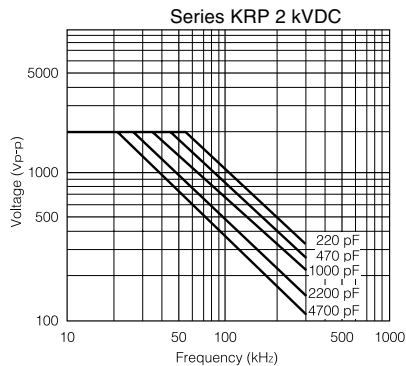
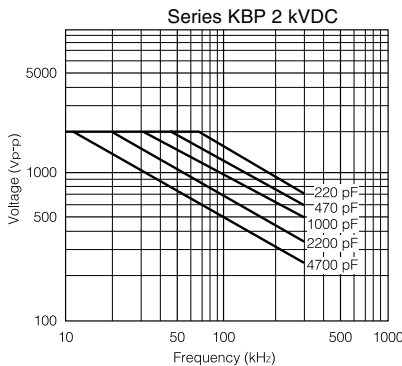
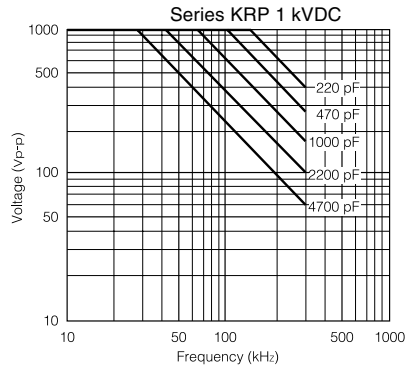
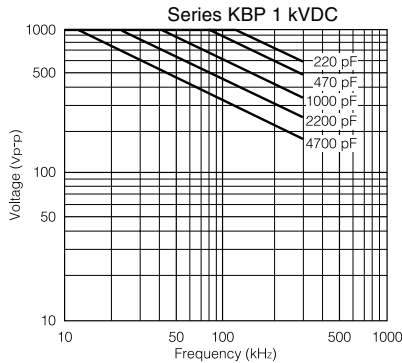

Above-mentioned graph shows the maximum permission Voltage when using a capacitor at the AC sine wave voltage.

As for this voltage, when measuring in room temperature (25 °C), the capacitor self generation of heat shows the voltage which becomes a maximum of 20 °C.

When using at the pulse voltage or AC voltage except the sine wave, Use on confirming that the capacitor self generation of heat temperature is less than 20 °C in room temperature (ambient temperature is 25 °C) The self generation of heat temperature (the difference between the surface temperature and the ambient temperature of capacitor) changes according to ambient temperature.

As for the permission self generation of heat temperature when the ambient temperature is more than 25 °C, refer to the right figure.

Permission self generation of heat temperature vs. ambient temperature

