

## 阅读申明

- 1.本站收集的数据手册和产品资料都来自互联网，版权归原作者所有。如读者和版权方有任何异议请及时告之，我们将妥善解决。
- 2.本站提供的中文数据手册是英文数据手册的中文翻译，其目的是协助用户阅读，该译文无法自动跟随原稿更新，同时也可能存在翻译上的不当。建议读者以英文原稿为参考以便获得更精准的信息。
- 3.本站提供的产品资料，来自厂商的技术支持或者使用者的心得体会等，其内容可能存在描述上的差异，建议读者做出适当判断。
- 4.如需与我们联系，请发邮件到marketing@iczoom.com，主题请标有“数据手册”字样。

## Read Statement

1. The datasheets and other product information on the site are all from network reference or other public materials, and the copyright belongs to the original author and original published source. If readers and copyright owners have any objections, please contact us and we will deal with it in a timely manner.
2. The Chinese datasheets provided on the website is a Chinese translation of the English datasheets. Its purpose is for reader's learning exchange only and do not involve commercial purposes. The translation cannot be automatically updated with the original manuscript, and there may also be improper translations. Readers are advised to use the English manuscript as a reference for more accurate information.
3. All product information provided on the website refer to solutions from manufacturers' technical support or users the contents may have differences in description, and readers are advised to take the original article as the standard.
4. If you have any questions, please contact us at marketing@iczoom.com and mark the subject with "Datasheets" .

# Multi-layer ceramic chip capacitors

## MCH15 (1005 (0402) size, chip capacitor)

●Features

- 1) Small size (1.0 x 0.5 x 0.5 mm) makes it perfect for lightweight portable devices.
- 2) Comes packed either in tape to enable automatic mounting or in bulk cases.
- 3) Precise uniformity of shape and dimensions facilitates highly efficient automatic mounting.
- 4) Barrier layer and end terminations to improve solderability.

●External dimensions (Units : mm)

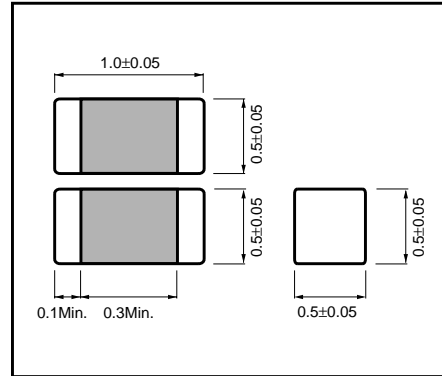

●Structure

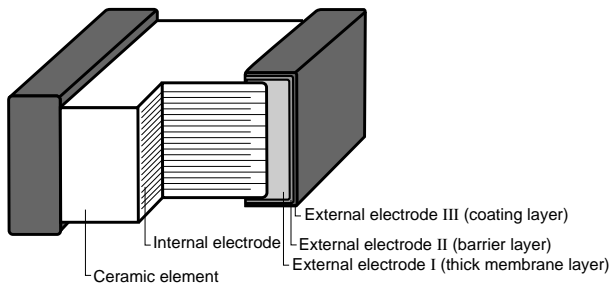

●Product designation

Code	Product thickness	Packaging specifications	Reel	Basic ordering unit (pcs.)
K	0.5mm	Paper tape (width 8 mm, pitch 2 mm)	φ180mm (7in.)	10,000
L	0.5mm	Paper tape (width 8 mm, pitch 2 mm)	φ330mm (13in.)	50,000
C	0.5mm	Bulk case	-	50,000

Reel (φ180, φ330mm) : compatible with EIAJ ET-7200A  
 Bulk case: compatible with EIAJ ET-7201A

Packaging style

Part No.



Code	Voltage
2	25V
3	16V
5	50V

Capacitance-temperature characteristics				Nominal capacitance	Capacitance tolerance	
Code	Code	Operating temperature (°C)	Temp. coefficient or percent change		Code	tolerance
A	CG(CoG)	-55~+125	0±30ppm/°C	3-digit designation according to IEC	C	± 0.25pF (0.5 - 5pF)
CN	R	-55~+125	±15%		D	± 0.5pF (5.1 - 10pF)
	B (X7R)	-25~+85 (-55~+125)	±10% (±15%)		J	± 5% (11pF or more)
FN	F	-25~+85	+30%,-80%		K	± 10%
	(Y5V)	(-30~+85)	(+22%,-82%)		Z	+ 80%, -20%

\*The design and specifications are subject to change without prior notice. Before ordering or using, please check the latest technical specification.

Ceramic capacitors

●Capacitance range

For thermal compensation

Part number		MCH15
Capacitance (pF)	Temperature characteristics	A (CG) (C0G)
	Rated voltage (V)	50V
Tolerance		
0.5	C (± 0.25pF)	<input type="checkbox"/>
0.75		<input type="checkbox"/>
1		<input type="checkbox"/>
1.1		<input type="checkbox"/>
1.2		<input type="checkbox"/>
1.3		<input type="checkbox"/>
1.5		<input type="checkbox"/>
1.6		<input type="checkbox"/>
1.8		<input type="checkbox"/>
2		<input type="checkbox"/>
2.2		<input type="checkbox"/>
2.4		<input type="checkbox"/>
2.7		<input type="checkbox"/>
3		<input type="checkbox"/>
3.3		<input type="checkbox"/>
3.6	<input type="checkbox"/>	
3.9	<input type="checkbox"/>	
4	<input type="checkbox"/>	
4.3	D (± 0.5pF)	<input type="checkbox"/>
4.7		<input type="checkbox"/>
5		<input type="checkbox"/>
5.1		<input type="checkbox"/>
5.6		<input type="checkbox"/>
6		<input type="checkbox"/>
6.2		<input type="checkbox"/>
6.8		<input type="checkbox"/>
7		<input type="checkbox"/>
7.5		<input type="checkbox"/>
8		<input type="checkbox"/>
8.2		<input type="checkbox"/>
9		<input type="checkbox"/>
9.1		<input type="checkbox"/>
10		<input type="checkbox"/>
11	J (± 5%)	<input type="checkbox"/>
12		<input type="checkbox"/>
13		<input type="checkbox"/>
15		<input type="checkbox"/>
16		<input type="checkbox"/>
18		<input type="checkbox"/>
20		<input type="checkbox"/>
22		<input type="checkbox"/>
24		<input type="checkbox"/>
27		<input type="checkbox"/>
30		<input type="checkbox"/>
33		<input type="checkbox"/>
36		<input type="checkbox"/>
39		<input type="checkbox"/>
43		<input type="checkbox"/>

Part number		MCH15
Capacitance (pF)	Temperature characteristics	A (CG) (C0G)
	Rated voltage (V)	50V
Tolerance		
47	J (± 5%)	<input type="checkbox"/>
51		<input type="checkbox"/>
56		<input type="checkbox"/>
62		<input type="checkbox"/>
68		<input type="checkbox"/>
75		<input type="checkbox"/>
82		<input type="checkbox"/>
91		<input type="checkbox"/>
100		<input type="checkbox"/>
110		<input type="checkbox"/>
120		<input type="checkbox"/>
130		<input type="checkbox"/>
150		<input type="checkbox"/>
160		<input type="checkbox"/>
180		<input type="checkbox"/>
200		<input type="checkbox"/>
220		<input type="checkbox"/>
240		<input type="checkbox"/>
270		<input type="checkbox"/>
300		<input type="checkbox"/>
330		<input type="checkbox"/>
360		<input type="checkbox"/>
390		<input type="checkbox"/>
430		<input type="checkbox"/>
470		<input type="checkbox"/>
510		<input type="checkbox"/>
560		<input type="checkbox"/>

Product thickness (mm) 0.5 ± 0.05

\*The design and specifications are subject to change without prior notice. Before ordering or using, please check the latest technical specification.

Ceramic capacitors

High dielectric constant

Part number		MCH15				
Capacitance (pF)	Temperature characteristics	CN (R) (B) (X7R)		FN (F) (Y5V)		
	Rated voltage (V)	50V	16V	50V	25V	16V
	Tolerance	K (±10%)		Z (+80, -20%)		
220		<input type="checkbox"/>				
270		<input type="checkbox"/>				
330		<input type="checkbox"/>				
390		<input type="checkbox"/>				
470		<input type="checkbox"/>				
560		<input type="checkbox"/>				
680		<input type="checkbox"/>				
820		<input type="checkbox"/>		<input type="checkbox"/>		
1,000		<input type="checkbox"/>		<input type="checkbox"/>		
1,200		<input type="checkbox"/>				
1,500		<input type="checkbox"/>				
1,800		<input type="checkbox"/>				
2,200		<input type="checkbox"/>		<input type="checkbox"/>		
2,700		<input type="checkbox"/>				
3,300		<input type="checkbox"/>				
3,900		<input type="checkbox"/>		<input type="checkbox"/>		
4,700		<input type="checkbox"/>		<input type="checkbox"/>		
5,600		<input type="checkbox"/>				
6,800		<input type="checkbox"/>				
8,200		<input type="checkbox"/>				
10,000 (0.01µF)			<input type="checkbox"/>	<input type="checkbox"/>		
12,000						
15,000						
18,000						
22,000					<input type="checkbox"/>	
27,000						
33,000						
39,000						
47,000						<input type="checkbox"/>
56,000						
68,000						
82,000						
100,000 (0.1µF)						<input type="checkbox"/>
120,000						
150,000						
180,000						
220,000						
270,000						
330,000						
390,000						
470,000						
560,000						



Product thickness (mm) 0.5 ± 0.05

\*The design and specifications are subject to change without prior notice. Before ordering or using, please check the latest technical specification.

## Ceramic capacitors

## ● Characteristics

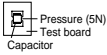
Class 1 (For thermal compensation)

Temperature characteristics		A (CG) (COG)	Test methods/conditions (based on JIS C 5102)
Item			
Operating temperature		-55°C ~ 125°C	—
Nominal capacitance (C)		Must be within the specified tolerance range.	Based on paragraph 7.8 and paragraph 9 Measured at room temperature and standard humidity, 1000pF or less Measurement frequency : 1 ± 0.1MHz Measurement voltage : 1 ± 0.1Vrms.
Dissipation factor (tanδ)		100/(400+20C)% or less: Less than 30 pF 0.1% or less : 30 pF or larger	Over 1000pF Measurement frequency : 1 ± 0.1kHz Measurement voltage : 1 ± 0.1Vrms.
Insulation resistance (IR)		10,000MΩ or 500MΩ · μF, whichever is smaller	Based on paragraph 7.6 Measurement is made after rated voltage is applied for 60 ± 5s.
Withstanding voltage		The insulation must not be damaged.	Based on paragraph 7.1 Apply 300% of the rated voltage for 1 to 5s then measure.
Temperature characteristics		Within 0 ± 30ppm/°C	The temperature coefficients in table 12, paragraph 7.12 are calculated at 20°C and high temperature.
Terminal adherence		No detachment or signs of detachment.	Based on paragraph 8.11. 2. Apply 5N for 10 ± 1s in the direction indicated by the arrow. 
Resistance to vibration	Appearance	There must be no mechanical damage.	Chip is mounted to a board in the manner shown on the right, subjected to vibration (type A in paragraph 8.2), and measured 24 ± 2 hrs. later. 
	Rate of capacitance change	Must be within initial tolerance.	
	Dissipation factor (tanδ)	Must satisfy initial specified value.	
Solderability		At least 3/4 of the surface of the two terminals must be covered with new solder.	Based on paragraph 8.13 Soldering temperature: 235 ± 5°C Soldering time : 2 ± 0.5s
Resistance to soldering heat	Appearance	There must be no mechanical damage.	Based on paragraph 8.14. Soldering temperature: 260 ± 5°C Soldering time : 5 ± 0.5s Preheating : 150 ± 10°C for 1 to 2 min.
	Rate of capacitance change	± 2.5% or ± 0.25 pF, whichever is larger.	
	Dissipation factor (tanδ)	Must satisfy initial specified value.	
	Insulation resistance	10,000MΩ or 500MΩ · μF, whichever is smaller	
	Withstanding voltage	The insulation must not be damaged.	
Temperature cycling	Appearance	There must be no mechanical damage.	Based on paragraph 9.3 Number of cycles : 5 Capacitance measured after 24 ± 2 hrs.
	Rate of capacitance change	± 2.5% or ± 0.25 pF, whichever is larger.	
	Dissipation factor (tanδ)	Must satisfy initial specified value.	
	Insulation resistance	10,000MΩ or 500MΩ · μF, whichever is smaller	
Humidity load test	Appearance	There must be no mechanical damage.	Based on paragraph 9.9 Test temperature: 40 ± 2°C Relative humidity: 90% to 95% Applied voltage : rated voltage Test time : 500 to 524 hrs. Capacitance measured after 24 ± 2 hrs.
	Rate of capacitance change	± 7.5% or ± 0.75 pF, whichever is larger.	
	Dissipation factor (tanδ)	0.5% or less	
	Insulation resistance	500MΩ or 25MΩ · μF, whichever is smaller	
High-temperature load test	Appearance	There must be no mechanical damage.	Based on paragraph 9.10 Test temperature : Max. operating temp. Applied voltage : rated voltage × 200% Test time : 1,000 to 1,048 hrs. Capacitance measured after 24 ± 2 hrs.
	Rate of capacitance change	± 3.0% or ± 0.3 pF, whichever is larger.	
	Dissipation factor (tanδ)	0.3% or less	
	Insulation resistance	1,000MΩ or 50MΩ · μF, whichever is smaller	

\*The design and specifications are subject to change without prior notice. Before ordering or using, please check the latest technical specification.

## Ceramic capacitors

Class 2 (High dielectric constant)

Temperature characteristics		CN (R) (B) (X7R)	FN (F) (Y5V)	Test methods/conditions (based on JIS C 5102)
Operating temperature		-55°C ~ +125°C	-30°C ~ +85°C	—
Nominal capacitance (C)		Must be within the specified tolerance range.		Based on paragraph 7.8 Measured at room temperature and standard humidity, Measurement frequency: 1 ± 0.1 kHz Measurement voltage : 1.0 ± 0.2 Vrms.
Dissipation factor (tanδ)		2.5% or less (when rated voltage is 16V: 3.5% or less)	5.0% or less (when rated voltage is 16V: 7.5% or less)	
Insulation resistance (IR)		10,000MΩ or 500MΩ · μF, whichever is smaller		Based on paragraph 7.6 Measurement is made after rated voltage is applied for 60 ± 5s.
Withstanding voltage		The insulation must not be damaged.		Based on paragraph 7.1 Apply 250% of the rated voltage for 1 to 5s then measure.
Temperature characteristics		Within ± 15%	+ 22, + 82%	The temperature coefficients in paragraph 7.12, table 8, condition B, are based on measurements carried out at 20°C, with no voltage applied.
Terminal adherence		No detachment or signs of detachment		Based on paragraph 8. 11. 2. Apply 5N for 10 ± 1s in the direction indicated by the arrow. 
Resistance to vibration	Appearance	There must be no mechanical damage.		Chip is mounted to a board in the manner shown on the right, subjected to vibration (type A in paragraph 8.2), and measured 48 ± 4 hrs. later. 
	Rate of capacitance change	Must be within initial tolerance.		
	Dissipation factor (tanδ)	Must satisfy initial specified value.		
Solderability		At least 3/4 of the surface of the two terminals must be covered with new solder.		Based on paragraph 8. 13 Soldering temperature : 235 ± 5°C Soldering time : 2 ± 0.5s
Resistance to soldering heat	Appearance	There must be no mechanical damage.		Based on paragraph 8. 14. Soldering temperature : 260 ± 5°C Soldering time : 5 ± 0.5s Preheating : 150 ± 10°C for 1 to 2 min.
	Rate of capacitance change	Within ± 5.0%	Within ± 20.0%	
	Dissipation factor (tanδ)	Must satisfy initial specified value.		
	Insulation resistance	10,000MΩ or 500MΩ · μF, whichever is smaller		
	Withstanding voltage	The insulation must not be damaged.		
Temperature cycling	Appearance	There must be no mechanical damage.		Based on paragraph 9.3 Number of cycles : 5 Capacitance measured after 48 ± 4 hrs.
	Rate of capacitance change	Within ± 7.5%	Within ± 20.0%	
	Dissipation factor (tanδ)	Must satisfy initial specified value.		
	Insulation resistance	10,000MΩ or 500MΩ · μF, whichever is smaller		
Humidity load test	Appearance	There must be no mechanical damage.		Based on paragraph 9.9 Test temperature : 40 ± 2°C Relative humidity : 90% to 95% Applied voltage : rated voltage Test time : 500 to 524 hrs. Capacitance measured after 48 ± 4 hrs.
	Rate of capacitance change	± 12.5% or less	Within ± 30.0%	
	Dissipation factor (tanδ)	5.0% or less	7.5% or less (when rated voltage is 16V: 10.0%)	
	Insulation resistance	500MΩ or 25MΩ · μF, whichever is smaller		
High-temperature load test	Appearance	There must be no mechanical damage.		Based on paragraph 9.10 Test temperature : Max. operating temp. Applied voltage : rated voltage × 200% Test time : 1,000 to 1,048 hrs. Capacitance measured after 48 ± 4 hrs.
	Rate of capacitance change	Within ± 10.0%	Within ± 30.0%	
	Dissipation factor (tanδ)	5.0% or less	7.5% or less (when rated voltage is 16V: 10.0%)	
	Insulation resistance	1,000MΩ or 50MΩ · μF, whichever is smaller		

\*The design and specifications are subject to change without prior notice. Before ordering or using, please check the latest technical specification.

Ceramic capacitors

●Packaging specifications

(Units : mm)

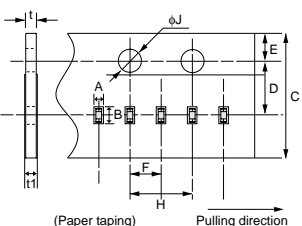
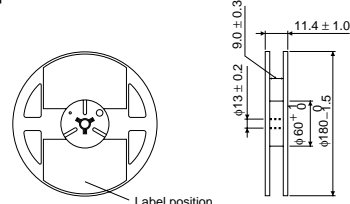
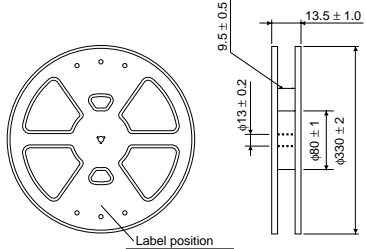
Taping	Reel																																			
	<p>φ180 mm plastic reel</p>  <p>φ330 mm plastic reel</p>  <p style="text-align: right;">EIAJ ET-7200A compliant</p>																																			
<table border="1" style="width: 100%; border-collapse: collapse;"> <thead> <tr> <th>Symbol</th> <th>C</th> <th>D</th> <th>E</th> <th>F</th> <th>H</th> <th>J</th> <th>t</th> <th>t1</th> </tr> </thead> <tbody> <tr> <td>Dimensions</td> <td>8.0</td> <td>3.5</td> <td>1.75</td> <td>2.0</td> <td>4.0</td> <td>φ1.5</td> <td>0.7</td> <td>0.8</td> </tr> <tr> <td></td> <td>±0.3</td> <td>±0.05</td> <td>±0.1</td> <td>±0.05</td> <td>±0.1</td> <td><math>\begin{smallmatrix} +0.1 \\ 0 \end{smallmatrix}</math></td> <td>±0.05</td> <td>MAX.</td> </tr> </tbody> </table> <table border="1" style="width: 100%; border-collapse: collapse;"> <thead> <tr> <th rowspan="2">Size</th> <th colspan="2">Symbol</th> </tr> <tr> <th>A</th> <th>B</th> </tr> </thead> <tbody> <tr> <td>1005</td> <td>0.65 ±0.1</td> <td>1.15 ±0.1</td> </tr> </tbody> </table>	Symbol	C	D	E	F	H	J	t	t1	Dimensions	8.0	3.5	1.75	2.0	4.0	φ1.5	0.7	0.8		±0.3	±0.05	±0.1	±0.05	±0.1	$\begin{smallmatrix} +0.1 \\ 0 \end{smallmatrix}$	±0.05	MAX.	Size	Symbol		A	B	1005	0.65 ±0.1	1.15 ±0.1	
Symbol	C	D	E	F	H	J	t	t1																												
Dimensions	8.0	3.5	1.75	2.0	4.0	φ1.5	0.7	0.8																												
	±0.3	±0.05	±0.1	±0.05	±0.1	$\begin{smallmatrix} +0.1 \\ 0 \end{smallmatrix}$	±0.05	MAX.																												
Size	Symbol																																			
	A	B																																		
1005	0.65 ±0.1	1.15 ±0.1																																		

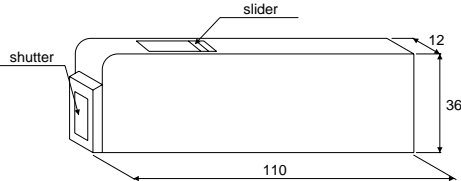
Bulk case		
		
EIAJ ET-7201 A compliant	<b>MCH15</b>	50,000pcs/case

\*The design and specifications are subject to change without prior notice. Before ordering or using, please check the latest technical specification.

Ceramic capacitors

● Electrical characteristics

■ A (COG) Characteristics

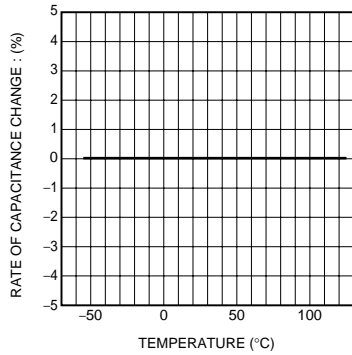

Fig.1 Capacitance-temperature characteristics

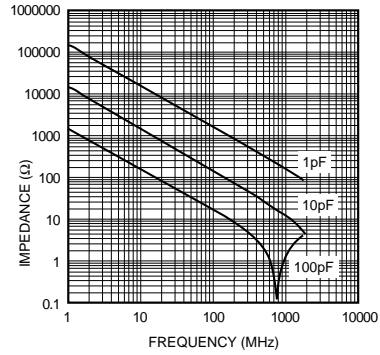

Fig.2 Impedance-frequency characteristics

■ CN (X7R) Characteristics

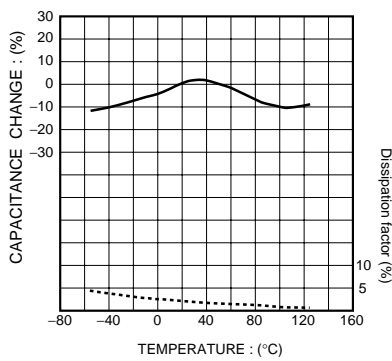

Fig.3 Capacitance-temperature characteristics

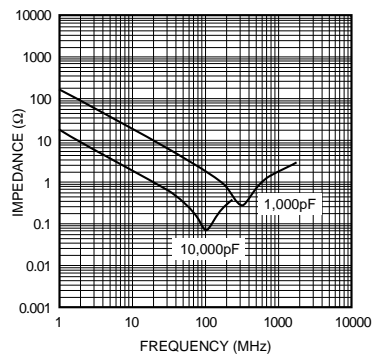

Fig.4 Impedance-frequency characteristics

■ FN (Y5V) Characteristics

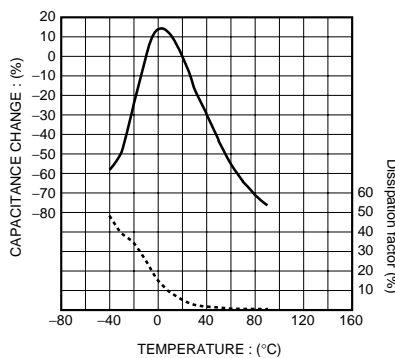

Fig.5 Capacitance-temperature characteristics

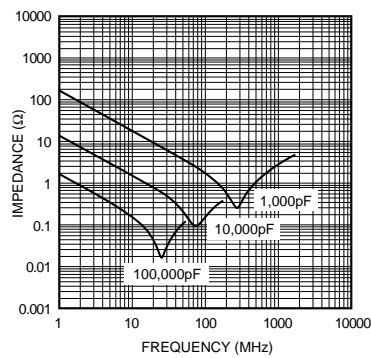

Fig.6 Impedance-frequency characteristics

\*The design and specifications are subject to change without prior notice. Before ordering or using, please check the latest technical specification.



Ceramic capacitors

■ Temperature cycling test

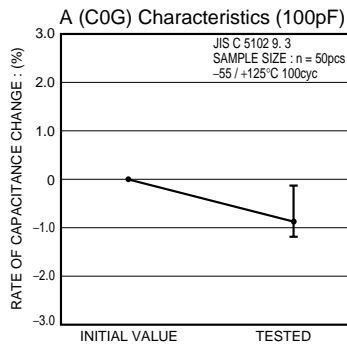

Fig.7 Rate of capacitance change

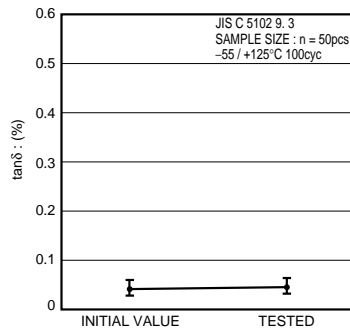

Fig.8 tanδ

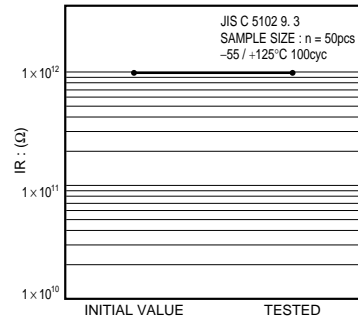

Fig.9 Insulation resistance

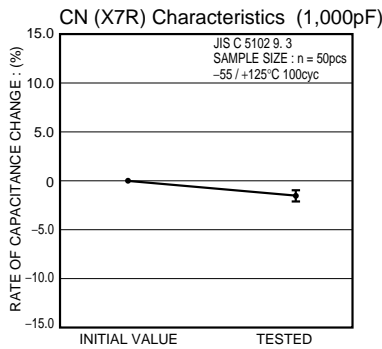

Fig.10 Rate of capacitance change

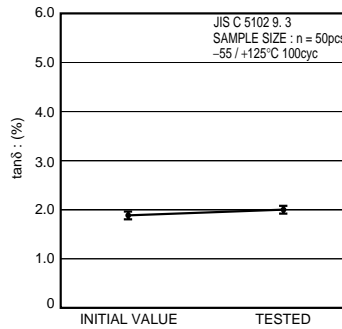

Fig.11 tanδ

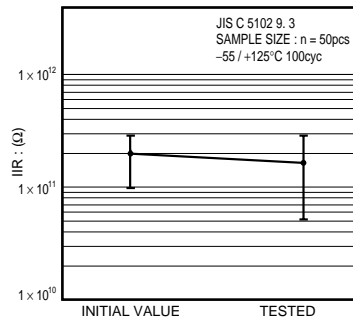

Fig.12 Insulation resistance

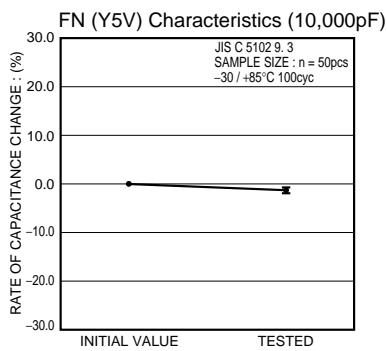

Fig.13 Rate of capacitance change

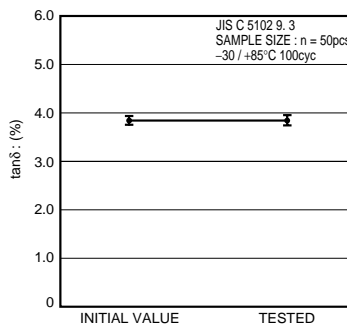

Fig.14 tanδ

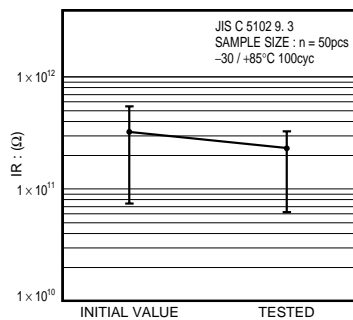

Fig.15 Insulation resistance

\*The design and specifications are subject to change without prior notice. Before ordering or using, please check the latest technical specification.

Ceramic capacitors

High-temperature load test

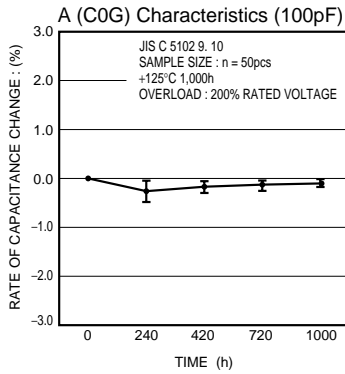

Fig.16 Rate of capacitance change

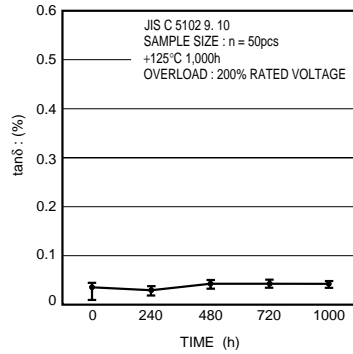

Fig.17 tanδ

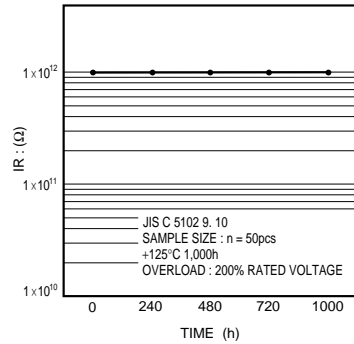

Fig.18 Insulation resistance

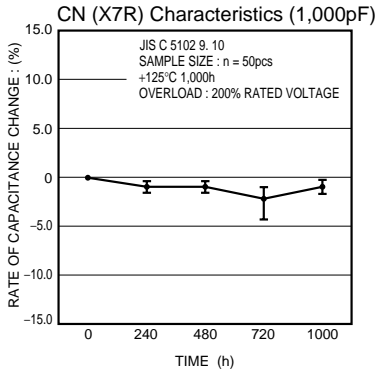

Fig.19 Rate of capacitance change

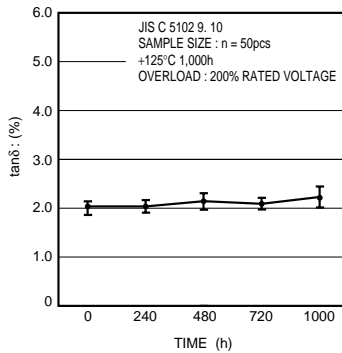

Fig.20 tanδ

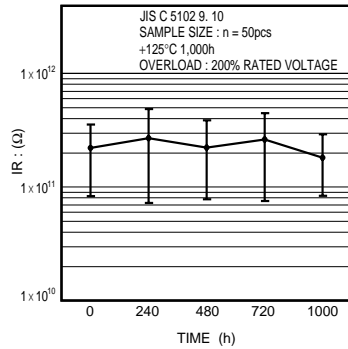

Fig.21 Insulation resistance

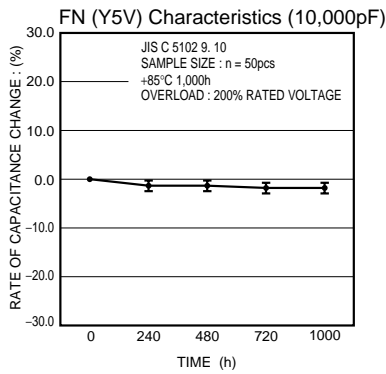

Fig.22 Rate of capacitance change

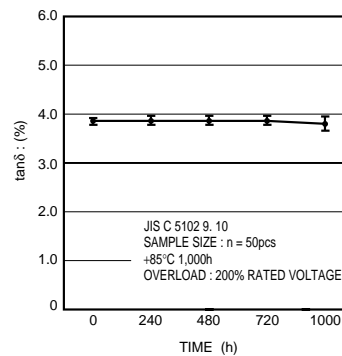

Fig.23 tanδ

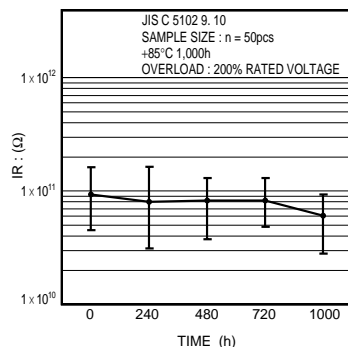

Fig.24 Insulation resistance

\*The design and specifications are subject to change without prior notice. Before ordering or using, please check the latest technical specification.

Ceramic capacitors

■ Humidity load test

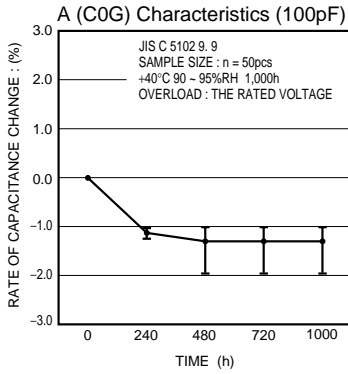

Fig.25 Rate of capacitance change

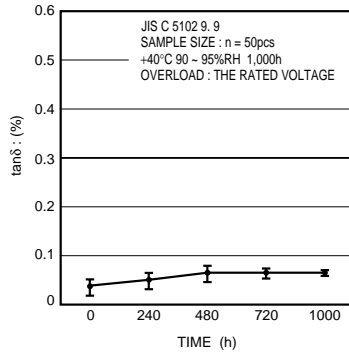

Fig.26 tanδ

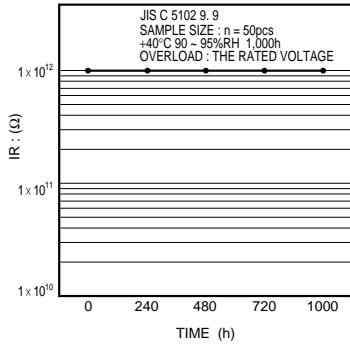

Fig.27 Insulation resistance

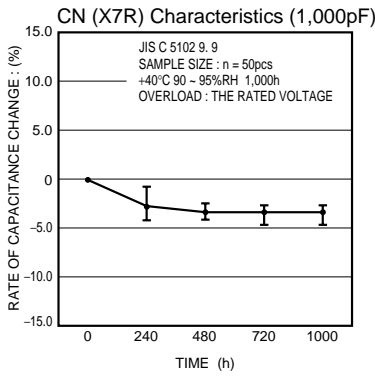

Fig.28 Rate of capacitance change

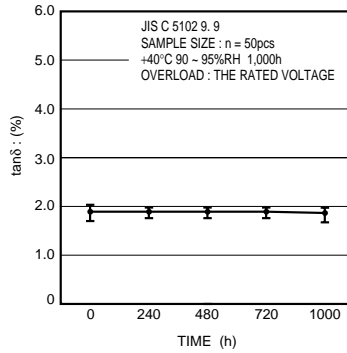

Fig.29 tanδ

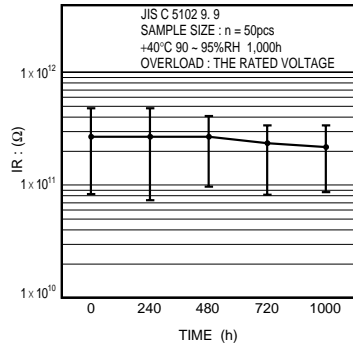

Fig.30 Insulation resistance

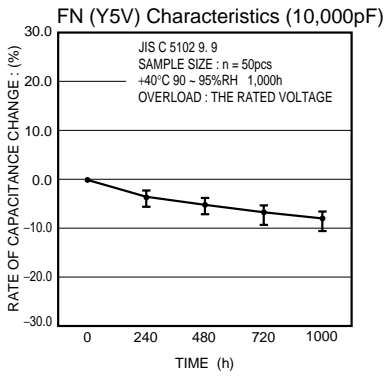

Fig.31 Rate of capacitance change

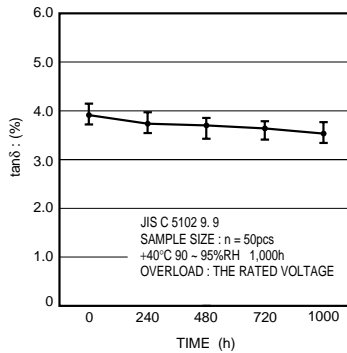

Fig.32 tanδ

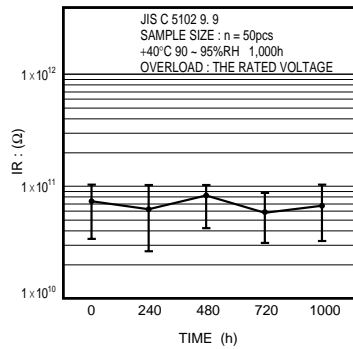

Fig.33 Insulation resistance

\*The design and specifications are subject to change without prior notice. Before ordering or using, please check the latest technical specification.