

阅读申明

- 1.本站收集的数据手册和产品资料都来自互联网，版权归原作者所有。如读者和版权方有任何异议请及时告之，我们将妥善解决。
- 2.本站提供的中文数据手册是英文数据手册的中文翻译，其目的是协助用户阅读，该译文无法自动跟随原稿更新，同时也可能存在翻译上的不当。建议读者以英文原稿为参考以便获得更精准的信息。
- 3.本站提供的产品资料，来自厂商的技术支持或者使用者的心得体会等，其内容可能存在描述上的差异，建议读者做出适当判断。
- 4.如需与我们联系，请发邮件到marketing@iczoom.com，主题请标有“数据手册”字样。

Read Statement

1. The datasheets and other product information on the site are all from network reference or other public materials, and the copyright belongs to the original author and original published source. If readers and copyright owners have any objections, please contact us and we will deal with it in a timely manner.
2. The Chinese datasheets provided on the website is a Chinese translation of the English datasheets. Its purpose is for reader's learning exchange only and do not involve commercial purposes. The translation cannot be automatically updated with the original manuscript, and there may also be improper translations. Readers are advised to use the English manuscript as a reference for more accurate information.
3. All product information provided on the website refer to solutions from manufacturers' technical support or users the contents may have differences in description, and readers are advised to take the original article as the standard.
4. If you have any questions, please contact us at marketing@iczoom.com and mark the subject with "Datasheets" .

High Voltage Ceramic Disc Capacitors (Low loss type)

Series: **KGE/Char. SL/GP, 1 to 6 kVDC**

Series: **KBP/Char. B/Y5P, 1 to 3 kVDC**

Series: **KRP/Char. R/Y5R, 1 to 3 kVDC**

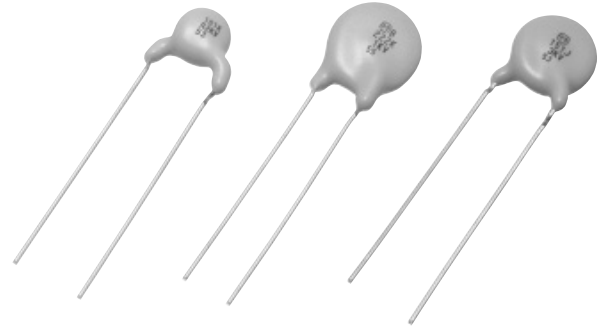

Features

- Wide operating temperature range: (-25 to 105 °C or -25 to 125 °C)
- Improved Voltage vs. Temperature Rise
- Flame-retardant insulated coating
- Easy mounting through kinked leads and radial taping

Recommended Applications

- Snubber circuit for switching power supply
- Horizontal resonance circuitry for TVs and CRT displays
- Inverter type lighting apparatus
- Ballast circuit for LCD backlighting inverter (For series KGE)
- Other high voltage pulse and DC circuitry

Explanation of Part Numbers

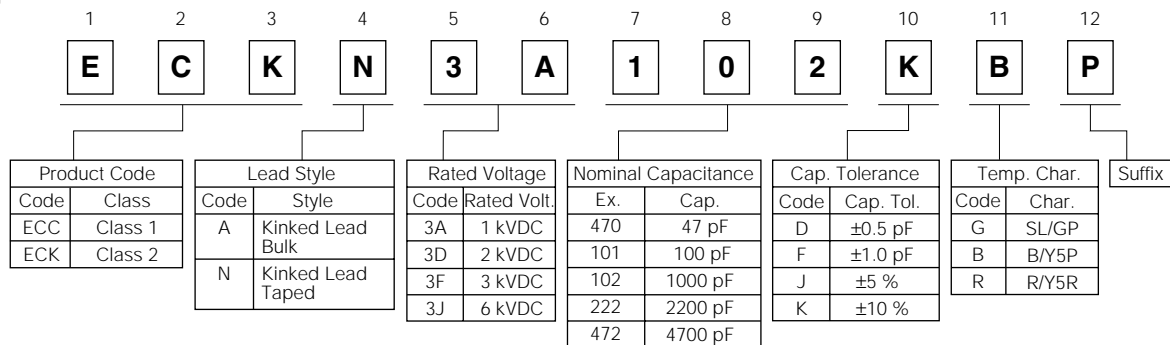

Specifications

Characteristic	Series KGE	Series KBP, KRP												
Operating Temperature Range	-25 to 105 °C	-25 to 125 °C												
Rated Voltage	1 kVDC to 6 kVDC	1 kVDC to 3 kVDC												
Dielectric Withstanding Voltage	Rated Voltage 1 to 3 kVDC: 200 % of Rated Voltage for 1 to 5 seconds Rated Voltage 6 kVDC: 150 % of Rated Voltage for 1 to 5 seconds	Rated Voltage 1 to 3 kVDC: 200 % of Rated Voltage for 1 to 5 seconds												
Capacitance	Within the specified tolerance, when measured at 1 MHz ± 20 %, 1 to 5 Vrms, and 20 °C	Within the specified tolerance, when measured at 1 kHz ± 20 %, 1 to 5 Vrms, and 20 °C												
Q or Dissipation Factor (tanδ)	30 pF or under Q > 400+20 C (C:Cap.pF) over 30 pF Q > 1000 at 1 MHz ± 20 %, 1 to 5 Vrms. and 20 °C	Series KBP : tanδ > 0.025 Series KRP : tanδ > 0.002 at 1 kHz ± 20 %, 1 to 5 Vrms. and 20 °C												
Insulation Resistance	10000 M Ω min. at 500 VDC 1 minute electrification													
Temperature Characteristics	Temperature Coefficient: +350 to -1000 ppm/°C (Temperature Range:20 to 85°C)	<table border="1"> <thead> <tr> <th>Series</th> <th>Temp.Char</th> <th>max.Cap.Change</th> <th>Temp. Range</th> </tr> </thead> <tbody> <tr> <td>KBP</td> <td>B/Y5P</td> <td>±10 %</td> <td>-25 to 85 °C</td> </tr> <tr> <td>KRP</td> <td>R/Y5R</td> <td>±15 %</td> <td>-25 to 85 °C</td> </tr> </tbody> </table>	Series	Temp.Char	max.Cap.Change	Temp. Range	KBP	B/Y5P	±10 %	-25 to 85 °C	KRP	R/Y5R	±15 %	-25 to 85 °C
Series	Temp.Char	max.Cap.Change	Temp. Range											
KBP	B/Y5P	±10 %	-25 to 85 °C											
KRP	R/Y5R	±15 %	-25 to 85 °C											

Rated Voltage and Capacitance Range

Series Name	Temp. Char.	Rated Voltage	Capacitance Range in pF				Typical Applications
			10	100	1000	10000	
Series KGE	SL	1 kVDC	[Bar chart showing range from 10 to 470 pF]				Ballast circuit of LCD backlighting inverter
		2 kVDC	[Bar chart showing range from 10 to 220 pF]				
		3 kVDC	[Bar chart showing range from 10 to 150 pF]				Snubber circuit of switching power supply
		6 kVDC	[Bar chart showing range from 10 to 150 pF]				
Series KBP	B	1 kVDC	[Bar chart showing range from 100 to 5600 pF]				Snubber circuit of switching power supply
		2 kVDC	[Bar chart showing range from 100 to 5600 pF]				Horizontal resonance circuit of TV and CRT display
		3 kVDC	[Bar chart showing range from 100 to 2700 pF]				
Series KRP	R	1 kVDC	[Bar chart showing range from 100 to 4700 pF]				Snubber circuit of switching power supply
		2 kVDC	[Bar chart showing range from 100 to 4700 pF]				
		3 kVDC	[Bar chart showing range from 100 to 2200 pF]				

Dimensions "D" (Body Diameter)

unit : mm

Cap. in pF	KGE				KBP			KRP		
	1 kV	2 kV	3 kV	6 kV	1 kV	2 kV	3 kV	1 kV	2 kV	3 kV
12 to 22	6.0	7.0	7.0	7.0						
22 to 33	6.0	7.0	7.0	8.0						
39	6.0	7.0	7.0	9.0						
47	6.0	7.0	7.0	9.0						
56	6.0	7.0	8.0	10.0						
68	6.0	7.0	8.0	11.0						
82	6.0	7.0	9.0	11.0						
100	7.0	8.0	10.0	13.0	6.0	7.0	7.5	6.0	7.0	7.5
120	7.0	8.0	10.0	13.0	6.0	7.0	7.5	6.0	7.0	7.5
150	8.0	9.0	11.0	15.0	6.0	7.0	7.5	6.0	7.0	7.5
180	8.0	10.0			6.0	7.0	7.5	6.0	7.0	7.5
220	9.0	10.0			6.0	7.0	7.5	6.0	7.0	8.0
270	9.0				6.0	7.0	7.5	6.0	7.0	8.0
330	11.0				6.0	7.0	8.0	6.0	7.5	8.5
390	11.0				6.0	7.0	9.0	7.0	7.5	9.5
470	13.0				6.0	7.5	9.5	7.0	9.0	9.5
560					7.0	8.0	10.0	7.0	9.0	10.5
680					7.0	9.0	11.0	7.5	10.0	10.5
820					7.5	9.0	11.0	7.5	10.0	12.5
1000					9.0	10.0	12.5	9.0	12.0	12.5
1200					9.0	10.5	14.5	9.0	12.0	14.5
1500					9.5	12.0	14.5	10.5	12.0	14.5
1800					12.0	12.5	16.0	10.5	14.0	16.5
2200					12.0	14.0	17.0	11.5	16.0	17.0
2700					13.5	16.0	18.5	13.0	16.0	
3300					13.5	17.0		13.0	19.0	
3900					15.5	18.0		14.0	20.0	
4700					15.5	25.0		16.5	21.0	
5600					17.0	25.0				

■ Dimensions in mm (not to scale)

Standard lead styles are available in Kinked Lead and Kinked Lead Taping shown below.

● Kinked Lead Taping Type N0, N1

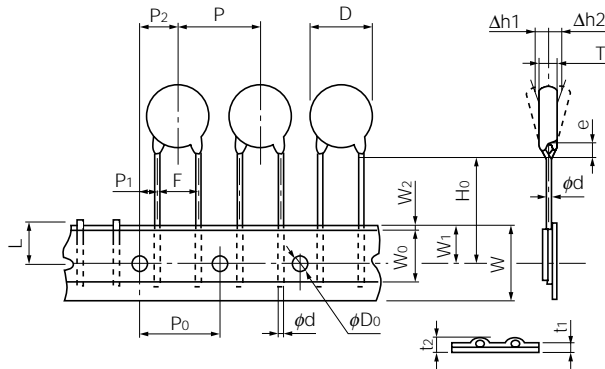

● Kinked Lead Type

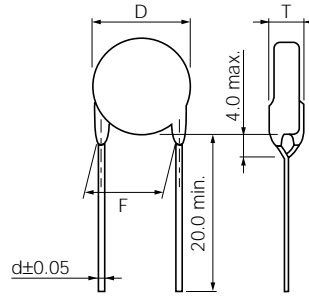

Note: Tolerance of Lead Space

Dim. F (Nominal)	Tolerance of Dim. F
5.0	±1.0
7.5	±1.5
10.0	±1.5

Type N2

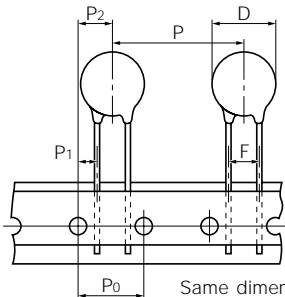

Same dimensions as Type N0, N1 except for special dimensions.

Unit (mm)

Taping Type ^a	N0	N1	N2
Symbol			
P	12.7±1.0	15.0±2.0	30.0±2.0
P ₀	12.7±0.3	15.0±0.3	15.0±0.3
F	5.0±0.8	7.5±1.0	7.5±1.0
P ₁	3.85±0.70	3.75±0.80	3.75±0.80
P ₂	6.35±1.30	7.5±1.5	7.5±1.5
D	To comply with each individual specification		
W	18.0 ^{+0.2} _{-0.2}		
W ₀	10.0 min.		
W ₁	9.0±0.5		
W ₂	3.0 max.		
H ₀	18.0 ^{+0.2} _{-0.2}		
e	4.0 max.		
φD ₀	4.0±0.2		
φd	0.60±0.05	0.65±0.05	0.65±0.05
t ₁	0.6±0.3		
t ₂	1.5 max.		
T	To comply with each individual specification		
Δh ₁ , Δh ₂	2.0 max.		
L	11.0 max.		

■ Minimum Quantity/Packing Unit

Series / Type		Part Number		Minimum Packing Quantity	Packing Quantity in Carton	Carton L×W×H(mm)		
Temp. Char. SL/GP 1 to 6 kVDC Series KGE	Kinked Lead Bulk 1 kVDC	ECCA3A□□□□GE	12 to 120 pF	200	5000	365×197×126		
			150 to 470 pF	200	4000			
	Kinked Lead Bulk 2 kVDC	ECCA3D□□□□GE	12 to 82 pF	200	10000			
			100 to 150 pF	200	4000			
	Kinked Lead Bulk 3 kVDC	ECCA3F□□□□GE	12 to 82 pF	200	4000			
			100 to 150 pF	200	2000			
	Kinked Lead Bulk 6 kVDC	ECCA3J□□□□GE	5 to 82 pF	200	3000			
			100 to 150 pF	200	2000			
	Kinked Lead Taped Type	1 kVDC	ECCN3A□□□□GE	12 to 470 pF	2000		10000	358×232×305
				12 to 220 pF	1000		5000	
2 kVDC		ECCN3D□□□□GE	12 to 150 pF	1000	5000			
			5 to 150 pF	500	2500			
3 kVDC		ECCN3F□□□□GE	12 to 150 pF	1000	5000			
			5 to 150 pF	500	2500			
Temp. Char. B/Y5P 1 to 3 kVDC Series KBP	Kinked Lead Bulk 1 kVDC	ECKA3A□□□□KBP	100 to 680 pF	200	5000	365×197×126		
			820 to 3900 pF	200	4000			
			4700 to 5600 pF	200	2000			
	Kinked Lead Bulk 2 kVDC	ECKA3D□□□□KBP	100 to 560 pF	200	4000			
			680 to 3900 pF	200	2000			
			4700 to 5600 pF	100	1000			
	Kinked Lead Bulk 3 kVDC	ECKA3F□□□□KBP	100 to 390 pF	200	4000			
			470 to 2200 pF	200	2000			
			2700 pF	100	1000			
			100 to 1000 pF	2000	10000			
Kinked Lead Taped Type 1 kVDC	ECKN3A□□□□KBP	1200 to 3300 pF	1000	5000	358×232×305			
		3900 to 4700 pF	500	2500				
		100 to 1800 pF	1000	5000				
Kinked Lead Taped Type 2 kVDC	ECKN3D□□□□KBP	2200 to 3900 pF	500	2500				
		100 to 1000 pF	1000	5000				
Kinked Lead Taped Type 3 kVDC	ECKN3F□□□□KBP	1200 to 2700 pF	500	2500				
		100 to 560 pF	200	5000				
Temp. Char. R/Y5R 1 to 3 kVDC Series KRP	Kinked Lead Bulk 1 kVDC	ECKA3A□□□□KRP	680 to 3900 pF	200		4000	365×197×126	
			4700 pF	200		2000		
			100 to 390 pF	200		4000		
	Kinked Lead Bulk 2 kVDC	ECKA3D□□□□KRP	470 to 2700 pF	200	2000			
			3300 to 4700 pF	100	1000			
			100 to 330 pF	200	4000			
Kinked Lead Bulk 3 kVDC	ECKA3F□□□□KRP	390 to 1500 pF	200	2000				
		1800, 2200 pF	200	1000				
		100 to 820 pF	2000	10000				
Kinked Lead Taped Type 1 kVDC	ECKN3A□□□□KRP	1000 to 2200 pF	1000	5000	358×232×305			
		2700 to 3900 pF	500	2500				
Kinked Lead Taped Type 2 kVDC	ECKN3D□□□□KRP	100 to 1500 pF	1000	5000				
		100 to 820 pF	1000	5000				
Kinked Lead Taped Type 3 kVDC	ECKN3F□□□□KRP	100 to 820 pF	1000	5000				

Design and specifications are each subject to change without notice. Ask factory for the current technical specifications before purchase and/or use. Should a safety concern arise regarding this product, please be sure to contact us immediately.

■ Ratings and Characteristics

- Series KGE (Class 1, Temp. Char. SL/GP, 1 kVDC to 6 kVDC)

Rated Volt.	Cap. in pF	Capacitance Tolerance (%)	Dimensions in mm		Kinked Lead Type (Bulk)			Kinked Lead Taping Type			
			D max.	T max.	Part Number	Dimensions in mm		Part Number	Taped Type	Dimensions in mm	
						F	d			F	d
1 kVDC	12	±5, ±10	6.0	5.0	ECCA3A120□GE	5.0	0.60	ECCN3A120□GE	NO	5.0	0.60
	15	±5, ±10	6.0	5.0	ECCA3A150□GE	5.0	0.60	ECCN3A150□GE	NO	5.0	0.60
	18	±5, ±10	6.0	5.0	ECCA3A180□GE	5.0	0.60	ECCN3A180□GE	NO	5.0	0.60
	22	±5, ±10	6.0	5.0	ECCA3A220□GE	5.0	0.60	ECCN3A220□GE	NO	5.0	0.60
	27	±5, ±10	6.0	5.0	ECCA3A270□GE	5.0	0.60	ECCN3A270□GE	NO	5.0	0.60
	33	±5, ±10	6.0	5.0	ECCA3A330□GE	5.0	0.60	ECCN3A330□GE	NO	5.0	0.60
	39	±5, ±10	6.0	5.0	ECCA3A390□GE	5.0	0.60	ECCN3A390□GE	NO	5.0	0.60
	47	±5, ±10	6.0	5.0	ECCA3A470□GE	5.0	0.60	ECCN3A470□GE	NO	5.0	0.60
	56	±5, ±10	6.0	5.0	ECCA3A560□GE	5.0	0.60	ECCN3A560□GE	NO	5.0	0.60
	68	±5, ±10	6.0	5.0	ECCA3A680□GE	5.0	0.60	ECCN3A680□GE	NO	5.0	0.60
	82	±5, ±10	6.0	5.0	ECCA3A820□GE	5.0	0.60	ECCN3A820□GE	NO	5.0	0.60
	100	±5, ±10	7.0	5.0	ECCA3A101□GE	5.0	0.60	ECCN3A101□GE	NO	5.0	0.60
	120	±5, ±10	7.0	5.0	ECCA3A121□GE	5.0	0.60	ECCN3A121□GE	NO	5.0	0.60
	150	±5, ±10	8.0	5.0	ECCA3A151□GE	5.0	0.60	ECCN3A151□GE	NO	5.0	0.60
	180	±5, ±10	8.0	5.0	ECCA3A181□GE	5.0	0.60	ECCN3A181□GE	NO	5.0	0.60
	220	±5, ±10	9.0	5.0	ECCA3A221□GE	5.0	0.60	ECCN3A221□GE	NO	5.0	0.60
	270	±5, ±10	9.0	5.0	ECCA3A271□GE	5.0	0.60	ECCN3A271□GE	NO	5.0	0.60
	330	±5, ±10	11.0	5.0	ECCA3A331□GE	5.0	0.60	ECCN3A331□GE	NO	5.0	0.60
390	±5, ±10	11.0	5.0	ECCA3A391□GE	5.0	0.60	ECCN3A391□GE	NO	5.0	0.60	
470	±5, ±10	13.0	5.0	ECCA3A471□GE	7.5	0.65	ECCN3A471□GE	N1	7.5	0.65	
2 kVDC	12	±5, ±10	7.0	5.5	ECCA3D120□GE	7.5	0.65	ECCN3D120□GE	N1	7.5	0.65
	15	±5, ±10	7.0	5.5	ECCA3D150□GE	7.5	0.65	ECCN3D150□GE	N1	7.5	0.65
	18	±5, ±10	7.0	5.5	ECCA3D180□GE	7.5	0.65	ECCN3D180□GE	N1	7.5	0.65
	22	±5, ±10	7.0	5.5	ECCA3D220□GE	7.5	0.65	ECCN3D220□GE	N1	7.5	0.65
	27	±5, ±10	7.0	5.5	ECCA3D270□GE	7.5	0.65	ECCN3D270□GE	N1	7.5	0.65
	33	±5, ±10	7.0	5.5	ECCA3D330□GE	7.5	0.65	ECCN3D330□GE	N1	7.5	0.65
	39	±5, ±10	7.0	5.5	ECCA3D390□GE	7.5	0.65	ECCN3D390□GE	N1	7.5	0.65
	47	±5, ±10	7.0	5.5	ECCA3D470□GE	7.5	0.65	ECCN3D470□GE	N1	7.5	0.65
	56	±5, ±10	7.0	5.5	ECCA3D560□GE	7.5	0.65	ECCN3D560□GE	N1	7.5	0.65
	68	±5, ±10	7.0	5.5	ECCA3D680□GE	7.5	0.65	ECCN3D680□GE	N1	7.5	0.65
	82	±5, ±10	7.0	5.5	ECCA3D820□GE	7.5	0.65	ECCN3D820□GE	N1	7.5	0.65
	100	±5, ±10	8.0	5.5	ECCA3D101□GE	7.5	0.65	ECCN3D101□GE	N1	7.5	0.65
120	±5, ±10	8.0	5.5	ECCA3D121□GE	7.5	0.65	ECCN3D121□GE	N1	7.5	0.65	
150	±5, ±10	9.0	5.5	ECCA3D151□GE	7.5	0.65	ECCN3D151□GE	N1	7.5	0.65	
180	±5, ±10	10.0	5.5	ECCA3D181□GE	7.5	0.65	ECCN3D181□GE	N1	7.5	0.65	
220	±5, ±10	10.0	5.5	ECCA3D221□GE	7.5	0.65	ECCN3D221□GE	N1	7.5	0.65	
3 kVDC	12	±5, ±10	7.0	6.0	ECCA3F120□GE	7.5	0.65	ECCN3F120□GE	N1	7.5	0.65
	15	±5, ±10	7.0	6.0	ECCA3F150□GE	7.5	0.65	ECCN3F150□GE	N1	7.5	0.65
	18	±5, ±10	7.0	6.0	ECCA3F180□GE	7.5	0.65	ECCN3F180□GE	N1	7.5	0.65
	22	±5, ±10	7.0	6.0	ECCA3F220□GE	7.5	0.65	ECCN3F220□GE	N1	7.5	0.65
	27	±5, ±10	7.0	6.0	ECCA3F270□GE	7.5	0.65	ECCN3F270□GE	N1	7.5	0.65
	33	±5, ±10	7.0	6.0	ECCA3F330□GE	7.5	0.65	ECCN3F330□GE	N1	7.5	0.65
	39	±5, ±10	7.0	6.0	ECCA3F390□GE	7.5	0.65	ECCN3F390□GE	N1	7.5	0.65
	47	±5, ±10	7.0	6.0	ECCA3F470□GE	7.5	0.65	ECCN3F470□GE	N1	7.5	0.65
	56	±5, ±10	8.0	6.0	ECCA3F560□GE	7.5	0.65	ECCN3F560□GE	N1	7.5	0.65
	68	±5, ±10	8.0	6.0	ECCA3F680□GE	7.5	0.65	ECCN3F680□GE	N1	7.5	0.65
	82	±5, ±10	9.0	6.0	ECCA3F820□GE	7.5	0.65	ECCN3F820□GE	N1	7.5	0.65
	100	±5, ±10	10.0	6.0	ECCA3F101□GE	7.5	0.65	ECCN3F101□GE	N1	7.5	0.65
120	±5, ±10	10.0	6.0	ECCA3F121□GE	7.5	0.65	ECCN3F121□GE	N1	7.5	0.65	
150	±5, ±10	11.0	6.0	ECCA3F151□GE	7.5	0.65	ECCN3F151□GE	N1	7.5	0.65	

Note : □--Capacitance Tolerance Code J (± 5%) or K (± 10%)

■ Ratings and Characteristics

- Series KGE (Class 1, Temp. Char. SL/GP, 1 to 6 kVDC) (Continuation)

Rated Volt.	Cap. in pF	Capacitance Tolerance (%)	Dimensions in mm		Kinked Lead Type (Bulk)			Kinked Lead Taping Type			
			D max.	T max.	Part Number	Dimensions in mm		Part Number	Taped Type	Dimensions in mm	
						F	d			F	d
6 kVDC	5	±0.5pF or ±1pF	7.0	6.0	ECCA3J050□GE	7.5	0.65	ECCN3J050□GE	N1	7.5	0.65
	6	±0.5pF or ±1pF	7.0	6.0	ECCA3J060□GE	7.5	0.65	ECCN3J060□GE	N1	7.5	0.65
	7	±0.5pF or ±1pF	7.0	6.0	ECCA3J070□GE	7.5	0.65	ECCN3J070□GE	N1	7.5	0.65
	8	±0.5pF or ±1pF	7.0	6.0	ECCA3J080□GE	7.5	0.65	ECCN3J080□GE	N1	7.5	0.65
	9	±0.5pF or ±1pF	7.0	6.0	ECCA3J090□GE	7.5	0.65	ECCN3J090□GE	N1	7.5	0.65
	10	±0.5pF or ±1pF	7.0	6.0	ECCA3J100□GE	7.5	0.65	ECCN3J100□GE	N1	7.5	0.65
	12	±5 or ±10	7.0	6.0	ECCA3J120□GE	7.5	0.65	ECCN3J120□GE	N1	7.5	0.65
	15	±5 or ±10	7.0	6.0	ECCA3J150□GE	7.5	0.65	ECCN3J150□GE	N1	7.5	0.65
	18	±5 or ±10	7.0	6.0	ECCA3J180□GE	7.5	0.65	ECCN3J180□GE	N1	7.5	0.65
	22	±5 or ±10	7.0	6.0	ECCA3J220□GE	7.5	0.65	ECCN3J220□GE	N1	7.5	0.65
	27	±5 or ±10	8.0	6.0	ECCA3J270□GE	7.5	0.65	ECCN3J270□GE	N1	7.5	0.65
	33	±5 or ±10	8.0	6.0	ECCA3J330□GE	7.5	0.65	ECCN3J330□GE	N1	7.5	0.65
	39	±5 or ±10	9.0	6.0	ECCA3J390□GE	7.5	0.65	ECCN3J390□GE	N1	7.5	0.65
	47	±5 or ±10	9.0	6.0	ECCA3J470□GE	7.5	0.65	ECCN3J470□GE	N1	7.5	0.65
	56	±5 or ±10	10.0	6.0	ECCA3J560□GE	7.5	0.65	ECCN3J560□GE	N1	7.5	0.65
	68	±5 or ±10	11.0	6.0	ECCA3J680□GE	7.5	0.65	ECCN3J680□GE	N1	7.5	0.65
	82	±5 or ±10	11.0	6.0	ECCA3J820□GE	7.5	0.65	ECCN3J820□GE	N1	7.5	0.65
	100	±5 or ±10	13.0	6.0	ECCA3J101□GE	7.5	0.65	ECCN3J101□GE	N1	7.5	0.65
120	±5 or ±10	13.0	6.0	ECCA3J121□GE	7.5	0.65	ECCN3J121□GE	N1	7.5	0.65	
150	±5 or ±10	15.0	6.0	ECCA3J151□GE	7.5	0.65	ECCN3J151□GE	N2	7.5	0.65	

Note : □--Capacitance Tolerance Code D (± 0.5pF) or F (± 1pF) or J (± 5%) or K (± 10%)

- Series KBP (Class 2, Temp. Char. B/Y5P, 1 to 3 kVDC)

Rated Volt.	Cap. in pF	Capacitance Tolerance (%)	Dimensions in mm		Kinked Lead Type (Bulk)			Kinked Lead Taping Type			
			D max.	T max.	Part Number	Dimensions in mm		Part Number	Taped Type	Dimensions in mm	
						F	d			F	d
1 kVDC	100	±10	6.0	4.5	ECKA3A101KBP	5.0	0.60	ECKN3A101KBP	N0	5.0	0.60
	120	±10	6.0	4.5	ECKA3A121KBP	5.0	0.60	ECKN3A121KBP	N0	5.0	0.60
	150	±10	6.0	4.5	ECKA3A151KBP	5.0	0.60	ECKN3A151KBP	N0	5.0	0.60
	180	±10	6.0	4.5	ECKA3A181KBP	5.0	0.60	ECKN3A181KBP	N0	5.0	0.60
	220	±10	6.0	4.5	ECKA3A221KBP	5.0	0.60	ECKN3A221KBP	N0	5.0	0.60
	270	±10	6.0	4.5	ECKA3A271KBP	5.0	0.60	ECKN3A271KBP	N0	5.0	0.60
	330	±10	6.0	4.5	ECKA3A331KBP	5.0	0.60	ECKN3A331KBP	N0	5.0	0.60
	390	±10	6.0	4.5	ECKA3A391KBP	5.0	0.60	ECKN3A391KBP	N0	5.0	0.60
	470	±10	6.0	4.5	ECKA3A471KBP	5.0	0.60	ECKN3A471KBP	N0	5.0	0.60
	560	±10	7.0	4.5	ECKA3A561KBP	5.0	0.60	ECKN3A561KBP	N0	5.0	0.60
	680	±10	7.0	4.5	ECKA3A681KBP	5.0	0.60	ECKN3A681KBP	N0	5.0	0.60
	820	±10	7.5	4.5	ECKA3A821KBP	5.0	0.60	ECKN3A821KBP	N0	5.0	0.60
	1000	±10	9.0	4.5	ECKA3A102KBP	5.0	0.60	ECKN3A102KBP	N0	5.0	0.60
	1200	±10	9.0	4.5	ECKA3A122KBP	5.0	0.60	ECKN3A122KBP	N0	5.0	0.60
	1500	±10	9.5	4.5	ECKA3A152KBP	5.0	0.60	ECKN3A152KBP	N0	5.0	0.60
	1800	±10	10.0	4.5	ECKA3A182KBP	5.0	0.60	ECKN3A182KBP	N0	5.0	0.60
	2200	±10	12.0	4.5	ECKA3A222KBP	5.0	0.60	ECKN3A222KBP	N0	5.0	0.60
	2700	±10	12.0	4.5	ECKA3A272KBP	5.0	0.60	ECKN3A272KBP	N0	5.0	0.60
	3300	±10	13.5	4.5	ECKA3A332KBP	10.0	0.65	ECKN3A332KBP	N1	7.5	0.65
	3900	±10	13.5	4.5	ECKA3A392KBP	10.0	0.65	ECKN3A392KBP	N1	7.5	0.65
4700	±10	15.5	4.5	ECKA3A472KBP	10.0	0.65	ECKN3A472KBP	N2	7.5	0.65	
5600	±10	17.0	4.5	ECKA3A562KBP	10.0	0.65	ECKN3A562KBP	N2	7.5	0.65	

■ Ratings and Characteristics

● Series KBP (Class 2, Temp. Char. B/Y5P, 1 to 3 kVDC) (Continuation)

Rated Volt.	Cap. in pF	Capacitance Tolerance (%)	Dimensions in mm		Kinked Lead Type (Bulk)			Kinked Lead Taping Type			
			D max.	T max.	Part Number	Dimensions in mm		Part Number	Taped Type	Dimensions in mm	
						F	d			F	d
2 kVDC	100	±10	7.0	5.0	ECKA3D101KBP	7.5	0.65	ECKN3D101KBP	N1	7.5	0.65
	120	±10	7.0	5.0	ECKA3D121KBP	7.5	0.65	ECKN3D121KBP	N1	7.5	0.65
	150	±10	7.0	5.0	ECKA3D151KBP	7.5	0.65	ECKN3D151KBP	N1	7.5	0.65
	180	±10	7.0	5.0	ECKA3D181KBP	7.5	0.65	ECKN3D181KBP	N1	7.5	0.65
	220	±10	7.0	5.0	ECKA3D221KBP	7.5	0.65	ECKN3D221KBP	N1	7.5	0.65
	270	±10	7.0	5.0	ECKA3D271KBP	7.5	0.65	ECKN3D271KBP	N1	7.5	0.65
	330	±10	7.0	5.0	ECKA3D331KBP	7.5	0.65	ECKN3D331KBP	N1	7.5	0.65
	390	±10	7.0	5.0	ECKA3D391KBP	7.5	0.65	ECKN3D391KBP	N1	7.5	0.65
	470	±10	7.5	5.0	ECKA3D471KBP	7.5	0.65	ECKN3D471KBP	N1	7.5	0.65
	560	±10	8.0	5.0	ECKA3D561KBP	7.5	0.65	ECKN3D561KBP	N1	7.5	0.65
	680	±10	9.0	5.0	ECKA3D681KBP	7.5	0.65	ECKN3D681KBP	N1	7.5	0.65
	820	±10	9.0	5.0	ECKA3D821KBP	7.5	0.65	ECKN3D821KBP	N1	7.5	0.65
	1000	±10	10.0	5.0	ECKA3D102KBP	7.5	0.65	ECKN3D102KBP	N1	7.5	0.65
	1200	±10	10.5	5.0	ECKA3D122KBP	7.5	0.65	ECKN3D122KBP	N1	7.5	0.65
	1500	±10	12.0	5.0	ECKA3D152KBP	7.5	0.65	ECKN3D152KBP	N1	7.5	0.65
	1800	±10	12.5	5.0	ECKA3D182KBP	7.5	0.65	ECKN3D182KBP	N1	7.5	0.65
	2200	±10	14.0	5.0	ECKA3D222KBP	10.0	0.65	ECKN3D222KBP	N2	7.5	0.65
	2700	±10	16.0	5.0	ECKA3D272KBP	10.0	0.65	ECKN3D272KBP	N2	7.5	0.65
	3300	±10	17.0	5.0	ECKA3D332KBP	10.0	0.65	ECKN3D332KBP	N2	7.5	0.65
	3900	±10	18.0	5.0	ECKA3D392KBP	10.0	0.65	ECKN3D392KBP	N2	7.5	0.65
4700	±10	25.0	5.0	ECKA3D472KBP	10.0	0.65	—	—	—	—	
5600	±10	25.0	5.0	ECKA3D562KBP	10.0	0.65	—	—	—	—	
3 kVDC	100	±10	7.5	6.0	ECKA3F101KBP	7.5	0.65	ECKN3F101KBP	N1	7.5	0.65
	120	±10	7.5	6.0	ECKA3F121KBP	7.5	0.65	ECKN3F121KBP	N1	7.5	0.65
	150	±10	7.5	6.0	ECKA3F151KBP	7.5	0.65	ECKN3F151KBP	N1	7.5	0.65
	180	±10	7.5	6.0	ECKA3F181KBP	7.5	0.65	ECKN3F181KBP	N1	7.5	0.65
	220	±10	7.5	6.0	ECKA3F221KBP	7.5	0.65	ECKN3F221KBP	N1	7.5	0.65
	270	±10	7.5	6.0	ECKA3F271KBP	7.5	0.65	ECKN3F271KBP	N1	7.5	0.65
	330	±10	8.0	6.0	ECKA3F331KBP	7.5	0.65	ECKN3F331KBP	N1	7.5	0.65
	390	±10	9.0	6.0	ECKA3F391KBP	7.5	0.65	ECKN3F391KBP	N1	7.5	0.65
	470	±10	9.5	6.0	ECKA3F471KBP	7.5	0.65	ECKN3F471KBP	N1	7.5	0.65
	560	±10	10.0	6.0	ECKA3F561KBP	7.5	0.65	ECKN3F561KBP	N1	7.5	0.65
	680	±10	11.0	6.0	ECKA3F681KBP	7.5	0.65	ECKN3F681KBP	N1	7.5	0.65
	820	±10	11.0	6.0	ECKA3F821KBP	7.5	0.65	ECKN3F821KBP	N1	7.5	0.65
	1000	±10	12.5	6.0	ECKA3F102KBP	7.5	0.65	ECKN3F102KBP	N1	7.5	0.65
	1200	±10	14.5	6.0	ECKA3F122KBP	10.0	0.65	ECKN3F122KBP	N1	7.5	0.65
	1500	±10	14.5	6.0	ECKA3F152KBP	10.0	0.65	ECKN3F152KBP	N1	7.5	0.65
	1800	±10	16.0	6.0	ECKA3F182KBP	10.0	0.65	ECKN3F182KBP	N2	7.5	0.65
2200	±10	17.0	6.0	ECKA3F222KBP	10.0	0.65	ECKN3F222KBP	N2	7.5	0.65	
2700	±10	18.5	6.0	ECKA3F272KBP	10.0	0.65	ECKN3F272KBP	N2	7.5	0.65	

■ Ratings and Characteristics

- Series KRP (Class 2, Temp. Char. R/Y5R, 1 to 3 kVDC)

Rated Volt.	Cap. in pF	Capacitance Tolerance (%)	Dimensions in mm		Kinked Lead Type (Bulk)			Kinked Lead Taping Type			
			D max.	T max.	Part Number	Dimensions in mm		Part Number	Taped Type	Dimensions in mm	
						F	d			F	d
1 kVDC	100	±10	6.0	4.5	ECKA3A101KRP	5.0	0.60	ECKN3A101KRP	NO	5.0	0.60
	120	±10	6.0	4.5	ECKA3A121KRP	5.0	0.60	ECKN3A121KRP	NO	5.0	0.60
	150	±10	6.0	4.5	ECKA3A151KRP	5.0	0.60	ECKN3A151KRP	NO	5.0	0.60
	180	±10	6.0	4.5	ECKA3A181KRP	5.0	0.60	ECKN3A181KRP	NO	5.0	0.60
	220	±10	6.0	4.5	ECKA3A221KRP	5.0	0.60	ECKN3A221KRP	NO	5.0	0.60
	270	±10	6.0	4.5	ECKA3A271KRP	5.0	0.60	ECKN3A271KRP	NO	5.0	0.60
	330	±10	6.0	4.5	ECKA3A331KRP	5.0	0.60	ECKN3A331KRP	NO	5.0	0.60
	390	±10	7.0	4.5	ECKA3A391KRP	5.0	0.60	ECKN3A391KRP	NO	5.0	0.60
	470	±10	7.0	4.5	ECKA3A471KRP	5.0	0.60	ECKN3A471KRP	NO	5.0	0.60
	560	±10	7.0	4.5	ECKA3A561KRP	5.0	0.60	ECKN3A561KRP	NO	5.0	0.60
	680	±10	7.5	4.5	ECKA3A681KRP	5.0	0.60	ECKN3A681KRP	NO	5.0	0.60
	820	±10	7.5	4.5	ECKA3A821KRP	5.0	0.60	ECKN3A821KRP	NO	5.0	0.60
	1000	±10	9.0	4.5	ECKA3A102KRP	5.0	0.60	ECKN3A102KRP	NO	5.0	0.60
	1200	±10	9.0	4.5	ECKA3A122KRP	5.0	0.60	ECKN3A122KRP	NO	5.0	0.60
	1500	±10	10.5	4.5	ECKA3A152KRP	5.0	0.60	ECKN3A152KRP	NO	5.0	0.60
	1800	±10	10.5	4.5	ECKA3A182KRP	5.0	0.60	ECKN3A182KRP	NO	5.0	0.60
	2200	±10	11.5	4.5	ECKA3A222KRP	5.0	0.60	ECKN3A222KRP	NO	5.0	0.60
	2700	±10	13.0	4.5	ECKA3A272KRP	7.5	0.65	ECKN3A272KRP	N1	7.5	0.65
	3300	±10	13.0	4.5	ECKA3A332KRP	7.5	0.65	ECKN3A332KRP	N1	7.5	0.65
	3900	±10	14.0	4.5	ECKA3A392KRP	7.5	0.65	ECKN3A392KRP	N1	7.5	0.65
4700	±10	16.5	4.5	ECKA3A472KRP	7.5	0.65	—	—	—	—	
2 kVDC	100	±10	7.0	5.0	ECKA3D101KRP	7.5	0.65	ECKN3D101KRP	N1	7.5	0.65
	120	±10	7.0	5.0	ECKA3D121KRP	7.5	0.65	ECKN3D121KRP	N1	7.5	0.65
	150	±10	7.0	5.0	ECKA3D151KRP	7.5	0.65	ECKN3D151KRP	N1	7.5	0.65
	180	±10	7.0	5.0	ECKA3D181KRP	7.5	0.65	ECKN3D181KRP	N1	7.5	0.65
	220	±10	7.0	5.0	ECKA3D221KRP	7.5	0.65	ECKN3D221KRP	N1	7.5	0.65
	270	±10	7.0	5.0	ECKA3D271KRP	7.5	0.65	ECKN3D271KRP	N1	7.5	0.65
	330	±10	7.5	5.0	ECKA3D331KRP	7.5	0.65	ECKN3D331KRP	N1	7.5	0.65
	390	±10	7.5	5.0	ECKA3D391KRP	7.5	0.65	ECKN3D391KRP	N1	7.5	0.65
	470	±10	9.0	5.0	ECKA3D471KRP	7.5	0.65	ECKN3D471KRP	N1	7.5	0.65
	560	±10	9.0	5.0	ECKA3D561KRP	7.5	0.65	ECKN3D561KRP	N1	7.5	0.65
	680	±10	10.0	5.0	ECKA3D681KRP	7.5	0.65	ECKN3D681KRP	N1	7.5	0.65
	820	±10	10.0	5.0	ECKA3D821KRP	7.5	0.65	ECKN3D821KRP	N1	7.5	0.65
	1000	±10	12.0	5.0	ECKA3D102KRP	7.5	0.65	ECKN3D102KRP	N1	7.5	0.65
	1200	±10	12.0	5.0	ECKA3D122KRP	7.5	0.65	ECKN3D122KRP	N1	7.5	0.65
	1500	±10	12.0	5.0	ECKA3D152KRP	7.5	0.65	ECKN3D152KRP	N1	7.5	0.65
	1800	±10	14.0	5.0	ECKA3D182KRP	10.0	0.65	—	—	—	—
	2200	±10	16.0	5.0	ECKA3D222KRP	10.0	0.65	—	—	—	—
	2700	±10	16.0	5.0	ECKA3D272KRP	10.0	0.65	—	—	—	—
	3300	±10	19.0	5.0	ECKA3D332KRP	10.0	0.65	—	—	—	—
	3900	±10	20.0	5.0	ECKA3D392KRP	10.0	0.65	—	—	—	—
4700	±10	21.0	5.0	ECKA3D472KRP	10.0	0.65	—	—	—	—	

■ Ratings and Characteristics

● Series KRP (Class 2, Temp. Char. R/Y5R, 1 to 3 kVDC) (Continuation)

Rated Volt.	Cap. in pF	Capacitance Tolerance (%)	Dimensions in mm		Kinked Lead Type (Bulk)			Kinked Lead Taping Type			
			D max.	T max.	Part Number	Dimensions in mm		Part Number	Taped Type	Dimensions in mm	
						F	d			F	d
3 kVDC	100	±10	7.5	5.5	ECKA3F101KRP	7.5	0.65	ECKN3F101KRP	N1	7.5	0.65
	120	±10	7.5	5.5	ECKA3F121KRP	7.5	0.65	ECKN3F121KRP	N1	7.5	0.65
	150	±10	7.5	5.5	ECKA3F151KRP	7.5	0.65	ECKN3F151KRP	N1	7.5	0.65
	180	±10	7.5	5.5	ECKA3F181KRP	7.5	0.65	ECKN3F181KRP	N1	7.5	0.65
	220	±10	8.0	5.5	ECKA3F221KRP	7.5	0.65	ECKN3F221KRP	N1	7.5	0.65
	270	±10	8.0	5.5	ECKA3F271KRP	7.5	0.65	ECKN3F271KRP	N1	7.5	0.65
	330	±10	8.5	5.5	ECKA3F331KRP	7.5	0.65	ECKN3F331KRP	N1	7.5	0.65
	390	±10	9.5	5.5	ECKA3F391KRP	7.5	0.65	ECKN3F391KRP	N1	7.5	0.65
	470	±10	9.5	5.5	ECKA3F471KRP	7.5	0.65	ECKN3F471KRP	N1	7.5	0.65
	560	±10	10.5	5.5	ECKA3F561KRP	7.5	0.65	ECKN3F561KRP	N1	7.5	0.65
	680	±10	10.5	5.5	ECKA3F681KRP	7.5	0.65	ECKN3F681KRP	N1	7.5	0.65
	820	±10	12.5	5.5	ECKA3F821KRP	7.5	0.65	ECKN3F821KRP	N1	7.5	0.65
	1000	±10	12.5	5.5	ECKA3F102KRP	10.0	0.65	---	---	---	---
	1200	±10	14.5	5.5	ECKA3F122KRP	10.0	0.65	---	---	---	---
	1500	±10	14.5	5.5	ECKA3F152KRP	10.0	0.65	---	---	---	---
	1800	±10	16.5	5.5	ECKA3F182KRP	10.0	0.65	---	---	---	---
2200	±10	17.0	5.5	ECKA3F222KRP	10.0	0.65	---	---	---	---	

■ Typical Temperature Characteristics

Series KGE (Char. SL/GP)

(Temp. Coeff. : +350 to -1000 ppm/°C)

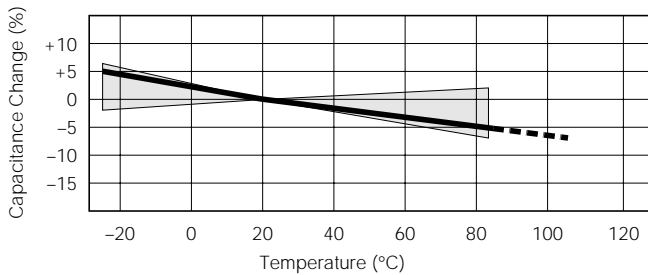

Series KBP (Char. B/Y5P)

(Temp. Range : -25 to 85 °C
max. Cap. Change : ±10 %)

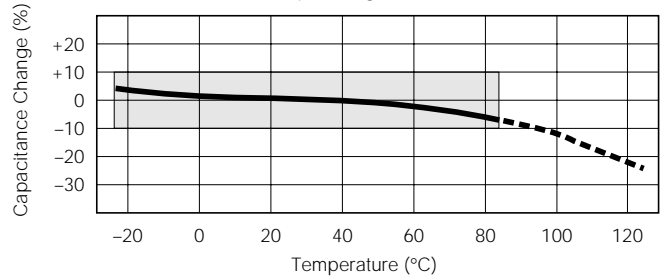

Series KRP (Char. R/Y5R)

(Temp. Range : -25 to 85 °C
max. Cap. Change : ±15 %)

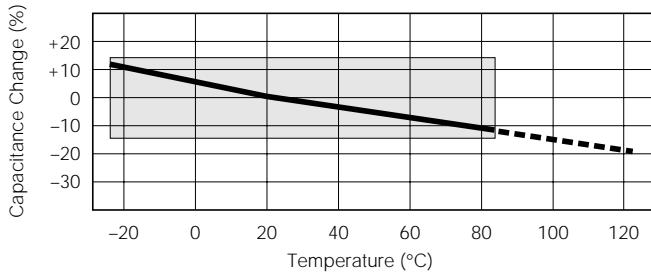

■ Characteristics of Voltage – Frequency

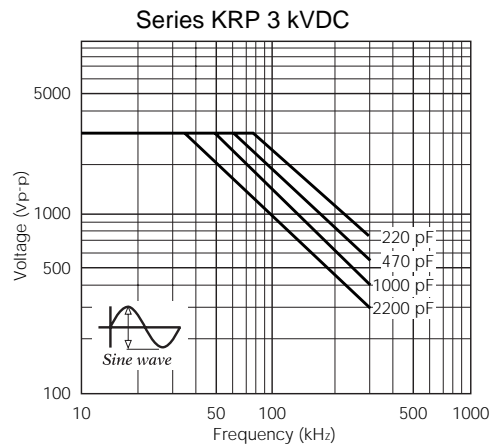
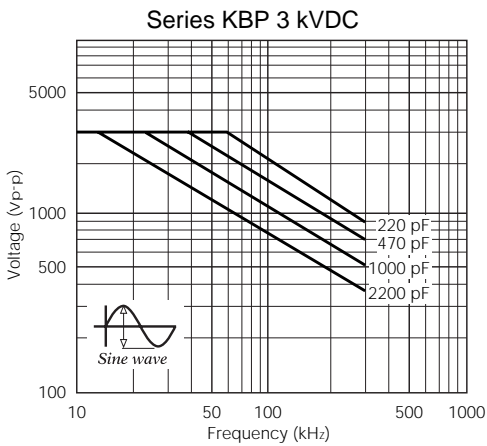
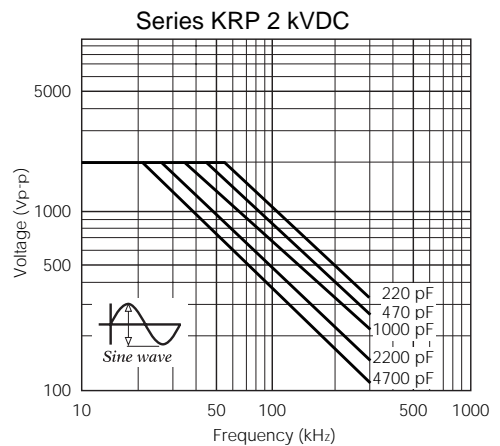
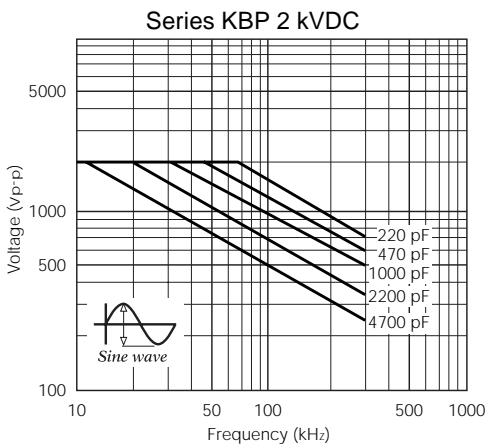
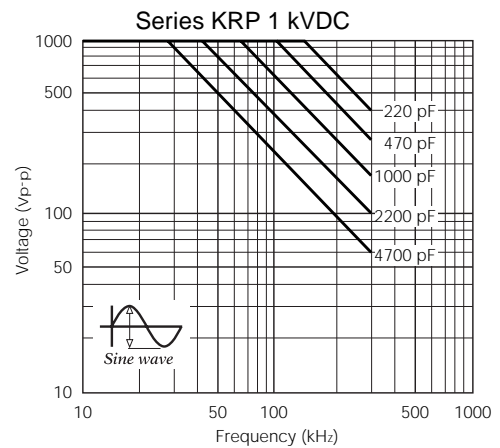
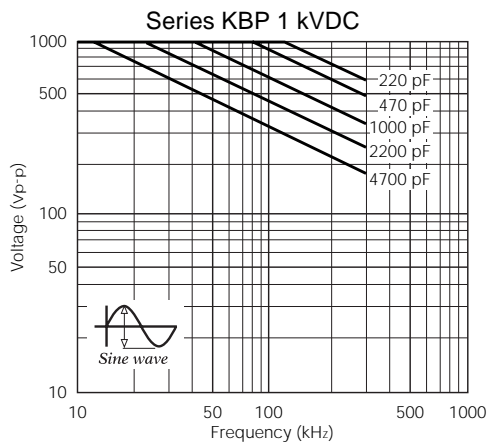

The graphs above show the maximum permissible voltage when using a capacitor with an AC sine wave voltage. When measuring this voltage in room temperature (25 °C), the capacitor self-heat generation will rise a maximum of 20 °C. When using a pulse voltage or an AC voltage other than a sine wave, confirm that the capacitor self-heat generation is less than 20 °C in an ambient room temperature of 25 °C. The self-heat generation temperature is the difference between the surface temperature and the ambient room temperature. As for the situation when the self-heat generation temperature is more than 25 °C, refer to the figure on the right.

Permission self generation of heat temperature vs. ambient temperature

