

## 阅读申明

- 1.本站收集的数据手册和产品资料都来自互联网，版权归原作者所有。如读者和版权方有任何异议请及时告之，我们将妥善解决。
- 2.本站提供的中文数据手册是英文数据手册的中文翻译，其目的是协助用户阅读，该译文无法自动跟随原稿更新，同时也可能存在翻译上的不当。建议读者以英文原稿为参考以便获得更精准的信息。
- 3.本站提供的产品资料，来自厂商的技术支持或者使用者的心得体会等，其内容可能存在描述上的差异，建议读者做出适当判断。
- 4.如需与我们联系，请发邮件到marketing@iczoom.com，主题请标有“数据手册”字样。

## Read Statement

1. The datasheets and other product information on the site are all from network reference or other public materials, and the copyright belongs to the original author and original published source. If readers and copyright owners have any objections, please contact us and we will deal with it in a timely manner.
2. The Chinese datasheets provided on the website is a Chinese translation of the English datasheets. Its purpose is for reader's learning exchange only and do not involve commercial purposes. The translation cannot be automatically updated with the original manuscript, and there may also be improper translations. Readers are advised to use the English manuscript as a reference for more accurate information.
3. All product information provided on the website refer to solutions from manufacturers' technical support or users the contents may have differences in description, and readers are advised to take the original article as the standard.
4. If you have any questions, please contact us at marketing@iczoom.com and mark the subject with "Datasheets" .

# Notice for TAIYO YUDEN products

Please read this notice before using the TAIYO YUDEN products.



## REMINDERS

- Product information in this catalog is as of October 2008. All of the contents specified herein are subject to change without notice due to technical improvements, etc. Therefore, please check for the latest information carefully before practical application or usage of the Products.

Please note that Taiyo Yuden Co., Ltd. shall not be responsible for any defects in products or equipment incorporating such products, which are caused under the conditions other than those specified in this catalog or individual specification.

- Please contact Taiyo Yuden Co., Ltd. for further details of product specifications as the individual specification is available.
- Please conduct validation and verification of products in actual condition of mounting and operating environment before commercial shipment of the equipment.
- All electronic components or functional modules listed in this catalog are developed, designed and intended for use in general electronics equipment.(for AV, office automation, household, office supply, information service, telecommunications, (such as mobile phone or PC) etc.). Before incorporating the components or devices into any equipment in the field such as transportation,( automotive control, train control, ship control), transportation signal, disaster prevention, medical, public information network (telephone exchange, base station) etc. which may have direct influence to harm or injure a human body, please contact Taiyo Yuden Co., Ltd. for more detail in advance.

Do not incorporate the products into any equipment in fields such as aerospace, aviation, nuclear control, submarine system, military, etc. where higher safety and reliability are especially required.

In addition, even electronic components or functional modules that are used for the general electronic equipment, if the equipment or the electric circuit require high safety or reliability function or performances, a sufficient reliability evaluation check for safety shall be performed before commercial shipment and moreover, due consideration to install a protective circuit is strongly recommended at customer's design stage.

- The contents of this catalog are applicable to the products which are purchased from our sales offices or distributors (so called "TAIYO YUDEN' s official sales channel"). It is only applicable to the products purchased from any of TAIYO YUDEN' s official sales channel.
- Please note that Taiyo Yuden Co., Ltd. shall have no responsibility for any controversies or disputes that may occur in connection with a third party's intellectual property rights and other related rights arising from your usage of products in this catalog. Taiyo Yuden Co., Ltd. grants no license for such rights.
- Caution for export  
Certain items in this catalog may require specific procedures for export according to "Foreign Exchange and Foreign Trade Control Law" of Japan, "U.S. Export Administration Regulations," and other applicable regulations. Should you have any question or inquiry on this matter, please contact our sales staff.  
Should you have any question or inquiry on this matter, please contact our sales staff.

# 一般積層セラミックコンデンサ (温度補償用・Class 1) STANDARD MULTILAYER CERAMIC CAPACITORS (CLASS1 : TEMPERATURE COMPENSATING DIELECTRIC TYPE)

OPERATING TEMP. -55~+125°C



リフロー／REFLOW

## 特長 FEATURES

- ・実装密度の向上が図れます
- ・モノリシックの構造のため、信頼性が高い
- ・同一形状、静電容量範囲が広い

- ・ Improve Higher Mounting Densities.
- ・ Multilayer block structure provides higher reliability
- ・ A wide range of capacitance values available in standard case sizes.

## 用途 APPLICATIONS

- ・ 一般電子機器用
- ・ 通信機器用 (携帯電話、PHS、コードレス電話 etc.)

- ・ General electronic equipment
- ・ Communication equipment (cellular phone, PHS, other wireless applications, etc.)

## 形名表記法 ORDERING CODE

<b>1</b> 定格電圧 [VDC]	<b>4</b> 形状寸法 (EIA) L×W [mm]	<b>6</b> 公称静電容量 [pF]	<b>7</b> 容量許容差	<b>9</b> 個別仕様
E 16 T 25 U 50	042 (01005) 0.4×0.2 063 (0201) 0.6×0.3 105 (0402) 1.0×0.5	例 0R5 0.5 010 1 100 10 ※R=小数点	C ± 0.25 pF D ± 0.5 pF F ± 1 pF J ± 5 % K ± 10 %	- 標準
<b>2</b> シリーズ名	<b>5</b> 温度特性 [ppm/°C]	<b>8</b> 製品厚み [mm]	<b>10</b> 包装	<b>11</b> 当社管理記号
M 積層コンデンサ	C□ 0 : CG, CH, CJ, CK R□ -220 : RH, S□ -330 : SH, SJ, SK G ±30 T□ -470 : TJ, TK H ±60 U□ -750 : UJ, UK J ±120 SL +350~-1000 K ±250 □=許容差	C 0.2 P 0.3 V 0.5 W 0.5	F φ178mm テーピング (2mmピッチ)	△ 標準品 △=スペース

U M K 1 0 5 C H 1 0 1 J V - F △

<b>1</b> Rated voltage [VDC]	<b>4</b> Dimensions (case size) [EIA] L×W [mm]	<b>6</b> Nominal capacitance [pF]	<b>7</b> Capacitance tolerance	<b>9</b> Special code
E 16 T 25 U 50	042 (01005) 0.4×0.2 063 (0201) 0.6×0.3 105 (0402) 1.0×0.5	example 0R5 0.5 010 1 100 10 *R=decimal point	C ± 0.25 pF D ± 0.5 pF F ± 1 pF J ± 5 % K ± 10 %	- Standard Products
<b>2</b> Series name	<b>5</b> Temperature characteristics [ppm/°C]	<b>8</b> Thickness [mm]	<b>10</b> Packaging	<b>11</b> Internal code
M Multilayer ceramic capacitor	C□ 0 : CG, CH, CJ, CK R□ -220 : RH, S□ -330 : SH, SJ, SK G ±30 T□ -470 : TJ, TK H ±60 U□ -750 : UJ, UK J ±120 SL +350~-1000 K ±250 □=Tolerance	C 0.2 P 0.3 V 0.5 W 0.5	F φ178mm Taping (2mm pitch)	△ Standard Products △=Blank space

# 外形寸法 EXTERNAL DIMENSIONS

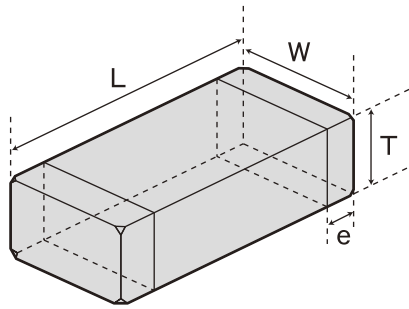

Type (EIA)	L	W	T		e
□MK042 (01005)	0.4±0.02 (0.016±0.001)	0.2±0.02 (0.008±0.001)	0.2±0.02 (0.008±0.001)	C	0.1±0.03 (0.004±0.001)
□MK063 (0201)	0.6±0.03 (0.024±0.001)	0.3±0.03 (0.012±0.001)	0.3±0.03 (0.012±0.001)	P	0.15±0.05 (0.006±0.002)
□MK105 (0402)	1.0±0.05 (0.039±0.002)	0.5±0.05 (0.020±0.002)	0.5±0.05 (0.020±0.002)	W, V	0.25±0.10 (0.010±0.004)

Unit : mm (inch)

# 概略バリエーション AVAILABLE CAPACITANCE RANGE

Cap [pF]	Type	042		063		105					
	Temp.char.	C□	C□	U□	C□	U□	SL	R□	S□	T□	
	VDC [pF:3digits]	16V	25V	50V							
0.5	0R5										
1	010										
1.5	1R5										
2	020										
3	030										
4	040										
5	050										
6	060										
7	070										
8	080										
9	090										
10	100	C	P								
12	120										
15	150										
18	180										
22	220										
27	270										
33	330										
39	390										
47	470										
56	560										
68	680										
82	820										
100	101										
120	121										
150	151										
180	181										
220	221										
270	271										
330	331										
390	391										
470	471										
560	561										
680	681										
820	821										
1000	102										

注:グラフの記号は製品の厚み記号です。

Note: Letters in the table indicate thickness.

## 温度特性 Temperature Characteristics

温度特性 Temperature char. (EIA)	温度係数範囲 (ppm/°C) ※1 Temperature coefficient range	使用温度範囲 Operating Temp. range
C K (C0K)	0±250	-55~+125°C
C J (C0J)	0±120	
C H (C0H)	0±60	
C G (C0G)	0±30	
R H (R2H)	-220±60	
S K (S2K)	-330±250	
S J (S2J)	-330±120	
S H (S2H)	-330±60	
T K (T2K)	-470±250	
T J (T2J)	-470±120	
U K (U2K)	-750±250	
U J (U2J)	-750±120	
S L	-1000~+350	

※1: 20°Cにおける静電容量を基準。  
Based on the capacitance at 20°C

## 静電容量許容差 Capacitance Tolerance Symbol

記号 Symbol	許容差 Tolerance	区分 Item
C	±0.25pF	~5pF
D	±0.5 pF	~10pF
F	±1pF	6~10 pF
J	±5 %	11pF~
K	±10 %	11pF~

## Q

Q※2 Symbol	区分 Item
≥400+20・C※1	~27pF
≥1000	30pF~

※1: C=公称静電容量 Nominal capacitance(pF)

※2: 測定周波数 Measurement Frequency= 1±0.1MHz (C≤1000pF)  
1±0.1kHz (C>1000pF)

測定電圧 Measurement voltage = 0.5~5Vrms (C≤1000pF)  
1±0.2Vrms (C>1000pF)

セレクションガイド  
Selection Guide

アイテム一覧  
Part Numbers

特性図  
Electrical Characteristics

梱包  
Packaging

信頼性  
Reliability Data

使用上の注意  
Precautions



etc

042TYPE

Class 1

定格電圧 Rated Voltage (DC)	形名 Ordering code	EHS (Environmental Hazardous Substances)	温度特性 Temperature characteristics (EIA)																	公称静電 容 量 Capacitance [pF]	静電容量 許容差 Capacitance tolerance	厚み Thicknees [mm] (inch)
			CK (C0K)	CJ (C0J)	CH (C0H)	CG (C0G)	PK (P2K)	PJ (P2J)	PH (P2H)	RK (R2K)	RJ (R2J)	RH (R2H)	SK (S2K)	SJ (S2J)	SH (S2H)	TK (T2K)	TJ (T2J)	TH (T2H)	UK (U2K)			
16V	EMK042 △ 0R5□C	RoHS	●		●															0.5	±0.25pF	0.2±0.02 (0.008±0.001)
	EMK042 △ 010□C	RoHS	●		●															1		
	EMK042 △ 1R5□C	RoHS	●		●															1.5		
	EMK042 △ 020□C	RoHS	●		●															2		
	EMK042 △ 030□C	RoHS		●	●															3		
	EMK042 △ 040□C	RoHS			●	●														4		
	EMK042 △ 050□C	RoHS			●	●														5		
	EMK042 △ 060□C	RoHS			●	●														6		
	EMK042 △ 070□C	RoHS			●	●														7		
	EMK042 △ 080□C	RoHS			●	●														8		
	EMK042 △ 090□C	RoHS			●	●														9		
	EMK042 △ 100□C	RoHS			●	●														10		
	EMK042 △ 120□C	RoHS			●	●														12		
	EMK042 △ 150□C	RoHS			●	●														15		
	EMK042 △ 180□P	RoHS			●	●														18		
	EMK042 △ 220□P	RoHS			●	●														22		
	EMK042 △ 270□P	RoHS			●	●														27		
	EMK042 △ 330□P	RoHS			●	●														33		
	EMK042 △ 390□P	RoHS			●	●														39		
	EMK042 △ 470□P	RoHS			●	●														47		
EMK042 △ 560□P	RoHS			●	●														56			
EMK042 △ 680□P	RoHS			●	●														68			
EMK042 △ 820□P	RoHS			●	●														82			
EMK042 △ 101□P	RoHS			●	●														100			

注:形名の△には温度特性、□には静電容量許容差記号が入ります。  
 △ Please specify the temperature characteristics code and □ the capacitance tolerance code.

063TYPE

Class 1

定格電圧 Rated Voltage (DC)	形名 Ordering code	EHS (Environmental Hazardous Substances)	温度特性 Temperature characteristics (EIA)																	公称静電 容 量 Capacitance [pF]	静電容量 許容差 Capacitance tolerance	厚み Thicknees [mm] (inch)
			CK (C0K)	CJ (C0J)	CH (C0H)	CG (C0G)	PK (P2K)	PJ (P2J)	PH (P2H)	RK (R2K)	RJ (R2J)	RH (R2H)	SK (S2K)	SJ (S2J)	SH (S2H)	TK (T2K)	TJ (T2J)	TH (T2H)	UK (U2K)			
25V	TMK063 △ 0R5□P	RoHS	●		●															0.5	±0.25pF	0.3±0.03 (0.012±0.001)
	TMK063 △ 010□P	RoHS	●		●															1		
	TMK063 △ 1R5□P	RoHS	●		●															1.5		
	TMK063 △ 020□P	RoHS	●		●															2		
	TMK063 △ 030□P	RoHS		●	●															3		
	TMK063 △ 040□P	RoHS			●	●														4		
	TMK063 △ 050□P	RoHS			●	●														5		
	TMK063 △ 060□P	RoHS			●	●														6		
	TMK063 △ 070□P	RoHS			●	●														7		
	TMK063 △ 080□P	RoHS			●	●														8		
	TMK063 △ 090□P	RoHS			●	●														9		
	TMK063 △ 100□P	RoHS			●	●														10		
	TMK063 △ 120□P	RoHS			●	●														12		
	TMK063 △ 150□P	RoHS			●	●														15		
	TMK063 △ 180□P	RoHS			●	●														18		
	TMK063 △ 220□P	RoHS			●	●														22		
	TMK063 △ 270□P	RoHS			●	●														27		
	TMK063 △ 330□P	RoHS			●	●														33		
	TMK063 △ 390□P	RoHS			●	●														39		
	TMK063 △ 470□P	RoHS			●	●														47		
TMK063 △ 560□P	RoHS			●	●														56			
TMK063 △ 680□P	RoHS			●	●														68			
TMK063 △ 820□P	RoHS			●	●														82			
TMK063 △ 101□P	RoHS			●	●														100			

注:形名の△には温度特性、□には静電容量許容差記号が入ります。  
 △ Please specify the temperature characteristics code and □ the capacitance tolerance code.

105TYPE

Class 1

定格電圧 Rated Voltage (DC)	形名 Ordering code	EHS (Environmental Hazardous Substances)	温度特性 Temperature characteristics (EIA)																	公称静電 容 量 Capacitance [pF]	静電容量 許 容 差 Capacitance tolerance	厚み Thickness [mm] (inch)		
			CK	CJ	CH	CG	PK	PJ	PH	RK	RJ	RH	RK	SJ	SH	TK	TJ	TH	UK				UJ	SL
			(C0K)	(C0J)	(C0H)	(C0G)	(P2K)	(P2J)	(P2H)	(R2K)	(R2J)	(R2H)	(S2K)	(S2J)	(S2H)	(T2K)	(T2J)	(T2H)	(U2K)				(U2J)	
50V	UMK105 △ 0R5□W	RoHS	●			●												●		0.5	±0.25pF	0.5±0.05 (0.02±0.002)		
	UMK105 △ 010□W	RoHS	●			●												●		1				
	UMK105 △ 1R5□W	RoHS	●			●												●		1.5				
	UMK105 △ 020□W	RoHS	●			●												●		2				
	UMK105 △ 030□W	RoHS		●		●												●		3				
	UMK105 △ 040□W	RoHS			●	●												●		4				
	UMK105 △ 050□W	RoHS			●	●												●		5				
	UMK105 △ 060□W	RoHS			●	●												●		6				
	UMK105 △ 070□W	RoHS			●	●												●		7				
	UMK105 △ 080□○	RoHS			●	●												●		8				
	UMK105 △ 090□○	RoHS			●	●												●		9				
	UMK105 △ 100□○	RoHS			●	●												●		10				
	UMK105 △ 120□○	RoHS			●	●												●		12				
	UMK105 △ 150□○	RoHS			●	●												●		15				
	UMK105 △ 180□○	RoHS			●	●												●		18				
	UMK105 △ 220□V	RoHS			●	●												●		22				
	UMK105 △ 270□V	RoHS			●	●												●		27				
	UMK105 △ 330□V	RoHS			●	●												●		33				
	UMK105 △ 390□V	RoHS			●	●												●		39				
	UMK105 △ 470□V	RoHS			●	●												●		47				
	UMK105 △ 560□V	RoHS			●	●												●		56				
	UMK105 △ 680□V	RoHS			●	●												●		68				
	UMK105 △ 820□V	RoHS			●	●												●		82				
	UMK105 △ 101□V	RoHS			●	●												●		100				
	UMK105 △ 121□V	RoHS			●	●												●		120				
	UMK105 △ 151□V	RoHS			●	●												●		150				
	UMK105 △ 181□V	RoHS			●	●												●		180				
	UMK105 △ 221□V	RoHS			●	●												●		220				
	UMK105 △ 271□V	RoHS			●	●												●		270				
	UMK105 △ 331□V	RoHS			●	●												●		330				
UMK105 SL121□V	RoHS																●		120					
UMK105 SL151□V	RoHS																●		150					
UMK105 SL181□V	RoHS																●		180					
UMK105 SL221□V	RoHS																●		220					
UMK105 SL271□V	RoHS																●		270					
UMK105 SL331□V	RoHS																●		330					

注:形名の△には温度特性、□には静電容量許容差記号、○にはCHの時には「V」、UJの時は「W」が入ります。  
 △ Please specify the temperature characteristics code. □ Please specify the capacitance tolerance code.  
 ○ comes to "V" when △ is "CH" and "W" when △ is "UJ".

105TYPE

Class 1

定格電圧 Rated Voltage (DC)	形名 Ordering code	EHS (Environmental Hazardous Substances)	温度特性 Temperature characteristics (EIA)																	公称静電 容 量 Capacitance [pF]	静電容量 許 容 差 Capacitance tolerance	厚み Thickness [mm] (inch)		
			CK	CJ	CH	CG	PK	PJ	PH	RK	RJ	RH	RK	SJ	SH	TK	TJ	TH	UK				UJ	SL
			(C0K)	(C0J)	(C0H)	(C0G)	(P2K)	(P2J)	(P2H)	(R2K)	(R2J)	(R2H)	(S2K)	(S2J)	(S2H)	(T2K)	(T2J)	(T2H)	(U2K)				(U2J)	
50V	UMK105 △ 0R5BW	RoHS												●		●				0.5	±0.1pF	0.5±0.05 (0.02±0.002)		
	UMK105 △ 010BW	RoHS												●		●				1				
	UMK105 △ 1R2BW	RoHS												●		●				1.2				
	UMK105 △ 1R5BW	RoHS												●		●				1.5				
	UMK105 △ 1R8BW	RoHS												●		●				1.8				
	UMK105 △ 2R2JW	RoHS												●		●				2.2				
	UMK105 △ 2R7JW	RoHS												●		●				2.7				
	UMK105 △ 3R3JW	RoHS												●		●				3.3				
	UMK105 △ 3R9JW	RoHS												●		●				3.9				
	UMK105 △ 4R7JW	RoHS												●		●		●		4.7				
	UMK105 △ 5R6JW	RoHS												●		●		●		5.6				
	UMK105 △ 6R8JW	RoHS												●		●		●		6.8				
	UMK105 △ 8R2JW	RoHS												●		●		●		8.2				
	UMK105 △ 100JW	RoHS												●		●		●		10				
	UMK105 △ 120JW	RoHS												●		●		●		12				
	UMK105 △ 150JW	RoHS												●		●		●		15				
	UMK105 △ 180JW	RoHS												●		●		●		18				
	UMK105 △ 200JW	RoHS												●		●		●		20				

注:形名の△には温度特性が入ります。  
 △ Please specify the temperature characteristics code.



# 梱包 PACKAGING

①最小受注単位数 Minimum Quantity

■テーピング梱包 Taped packaging

形式 (EIA) Type	製品厚み Thickness		標準数量 Standard quantity [ pcs ]	
	mm (inch)	code	紙テープ paper	エンボステープ Embossed tape
□MK042(01005)	0.2 (0.008)	C	15000	—
□MK063(0201)	0.3 (0.012)	P	15000	—
□2K096(0302)	0.3 (0.012)	P	10000	—
	0.45 (0.018)	K		
□WK105(0204)	0.3 (0.012)	P	10000	—
□MK105(0402)	0.5 (0.020)	V, W	10000	—
		W		
□MK107(0603)	0.45 (0.018)	K	4000	—
		V		
□WK107(0306)	0.5 (0.020)	V	—	4000
		A		
□2K110(0504)	0.8 (0.031)	V	4000	—
		A		
		B		
□MK212(0805)	0.45 (0.018)	K	4000	—
		D		
□WK212(0508)	0.85 (0.033)	D	4000	—
		G		
□4K212(0805)	0.85 (0.033)	D	4000	—
		D		
□2K212(0805)	0.85 (0.033)	D	4000	—
		D		
□MK316(1206)	0.85 (0.033)	F	—	3000
		G		
		L		
□MK325(1210)	0.85 (0.033)	D	—	2000
		F		
		H		
		N		
		Y		
□MK432(1812)	2.5 (0.098)	M	—	500(T), 1000(P)
		M		500

②テーピング材質 Taping material

紙テープ  
Card board carrier tape

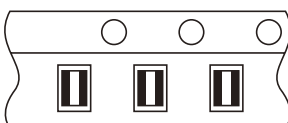
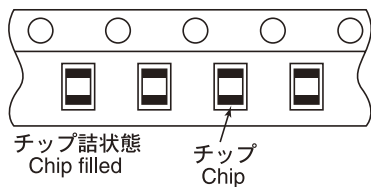
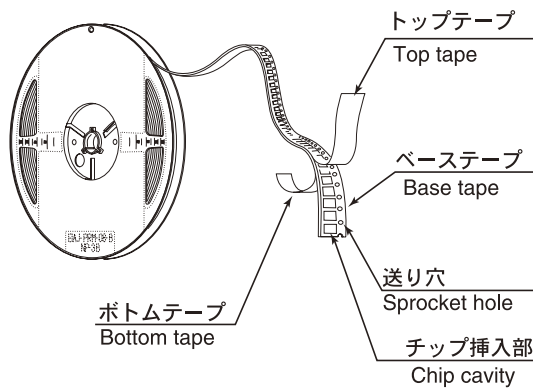

※□WK

※プレスポケットタイプは、  
ボトムテープ無し。

エンボステープ  
Embossed Tape

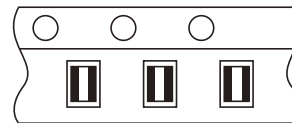
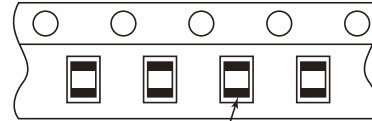
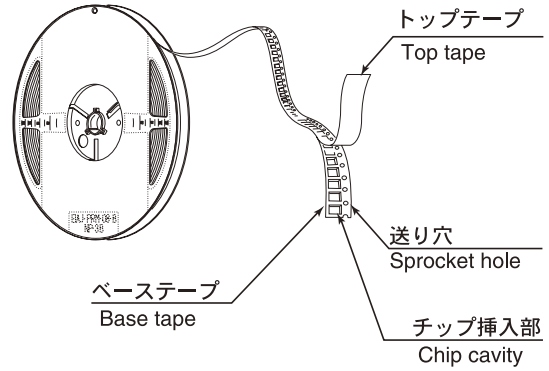

※□WK

③バルクカセット Bulk Cassette

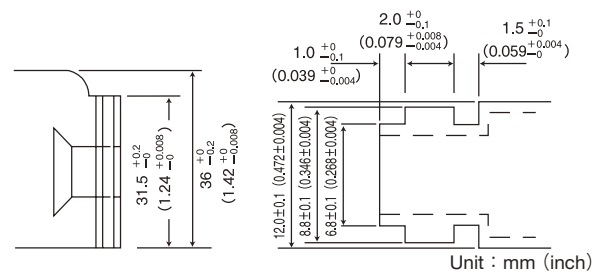
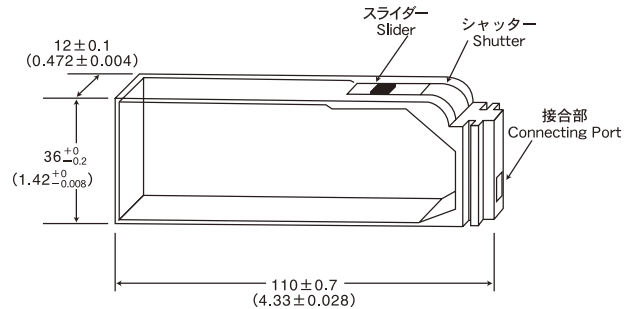

105, 107, 212形状で個別対応致しますのでお問い合わせ下さい。  
Please contact any of our offices for accepting your requirement according to dimensions 0402, 0603, 0805.(inch)

# 梱包 PACKAGING

③テーピング寸法 Taping dimensions  
紙テープ Paper Tape (8mm幅) (0.315inches wide)

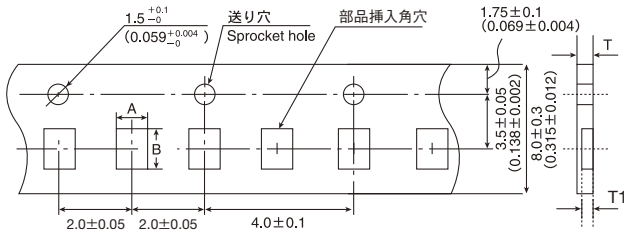

Type (EIA)	チップ挿入部 Chip Cavity		挿入ピッチ Insertion Pitch F	テープ厚み Tape Thickness	
	A	B		T	T1
□MK042 (01005)	0.25 (0.010)	0.45 (0.018)	2.0±0.05 (0.079±0.002)	0.36max. (0.014)	0.27max. (0.011)
□MK063 (0201)	0.37 (0.016)	0.67 (0.027)	2.0±0.05 (0.079±0.002)	0.45max. (0.018)	0.42max. (0.017)
□WK105 (0204)	0.65 (0.026)	1.15 (0.045)	2.0±0.05 (0.079±0.002)	0.45max (0.018max)	0.42max (0.017max)

Unit : mm (inch)

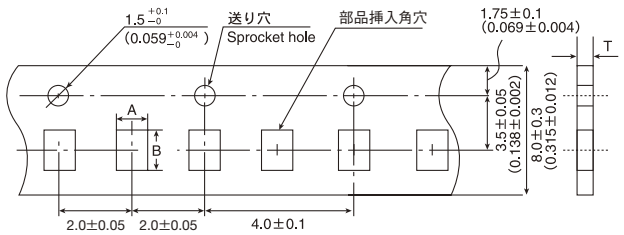

Type (EIA)	チップ挿入部 Chip Cavity		挿入ピッチ Insertion Pitch F	テープ厚み Tape Thickness T
	A	B		
□2K096 (0302)	0.72 (0.028)	1.02 (0.040)	2.0±0.05 (0.079±0.002)	0.45max.(0.018max) 0.6max.(0.024max)
□MK105 (0402)	0.65 (0.026)	1.15 (0.045)	2.0±0.05 (0.079±0.002)	0.8max. (0.031max.)
□VK105 (0402)	0.65 (0.026)	1.15 (0.045)	2.0±0.05 (0.079±0.002)	0.8max. (0.031max.)

Unit : mm (inch)

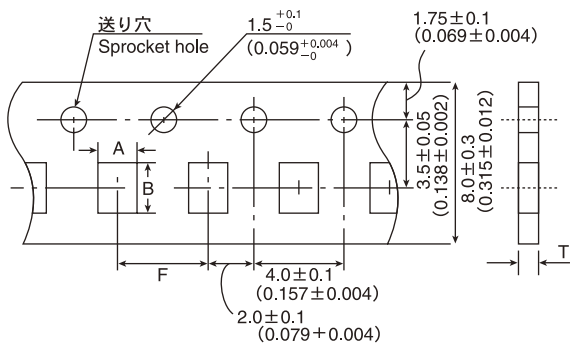

Type (EIA)	チップ挿入部 Chip Cavity		挿入ピッチ Insertion Pitch F	テープ厚み Tape Thickness T
	A	B		
□MK107 (0603)	1.0 (0.039)	1.8 (0.071)	4.0±0.1 (0.157±0.004)	1.1max. (0.043max.)
□WK107 (0306)	1.0 (0.039)	1.8 (0.071)	4.0±0.1 (0.157±0.004)	1.1max. (0.043max.)
□2K110 (0504)	1.15 (0.045)	1.55 (0.061)	4.0±0.1 (0.157±0.004)	1.0max. (0.039max.)
□MK212 (0805)	1.65 (0.065)	2.4 (0.094)	4.0±0.1 (0.157±0.004)	1.1max. (0.043max.)
□WK212 (0508)				
□4K212 (0805)				
□2K212 (0805)				
□MK316 (1206)	2.0 (0.079)	3.6 (0.142)	4.0±0.1 (0.157±0.004)	1.1max. (0.043max.)

Unit : mm (inch)

エンボステープ Embossed tape (8mm幅) (0.315inches wide)

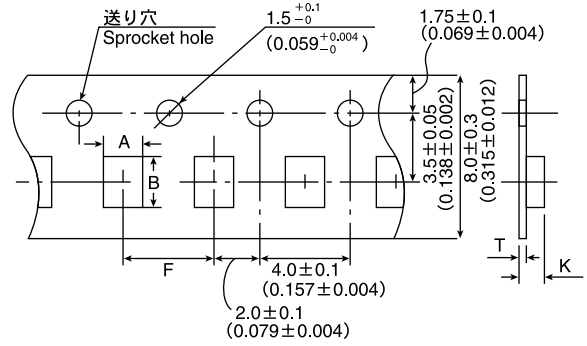

Type (EIA)	チップ挿入部 Chip cavity		挿入ピッチ Insertion Pitch F	テープ厚み Tape Thickness	
	A	B		K	T
□WK107 (0306)	1.0 (0.039)	1.8 (0.071)	4.0±0.1 (0.157±0.004)	1.3max. (0.051max.)	0.25±0.1 (0.01±0.004)
□MK212 (0805)	1.65 (0.065)	2.4 (0.094)		3.4max. (0.134max.)	0.6max. (0.024max.)
□MK316 (1206)	2.0 (0.079)	3.6 (0.142)	4.0±0.1 (0.157±0.004)	3.4max. (0.134max.)	0.6max. (0.024max.)
□MK325 (1210)	2.8 (0.110)	3.6 (0.142)		3.4max. (0.134max.)	0.6max. (0.024max.)

Unit : mm (inch)

エンボステープ Embossed tape (12mm幅) (0.472inches wide)

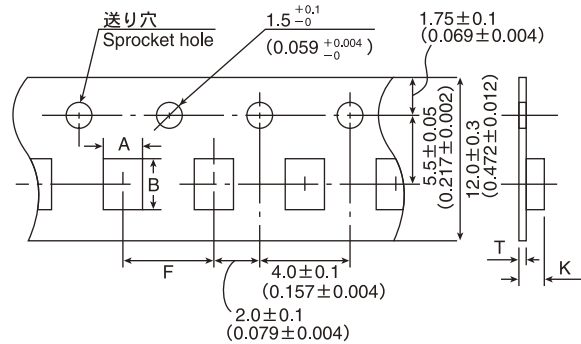

Type (EIA)	チップ挿入部 Chip cavity		挿入ピッチ Insertion Pitch F	テープ厚み Tape Thickness	
	A	B		K	T
□MK432 (1812)	3.7 (0.146)	4.9 (0.193)	8.0±0.1 (0.315±0.004)	4.0max. (0.157max.)	0.6max. (0.024max.)

Unit : mm (inch)



④リーダー部／空部 Leader and Blank portion

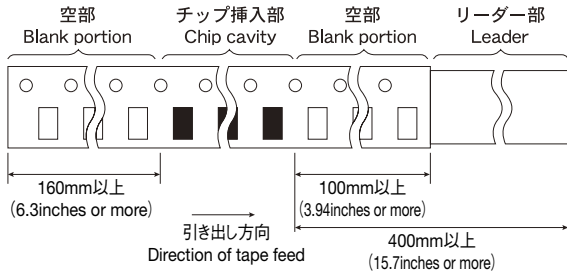

⑤リール寸法 Reel size

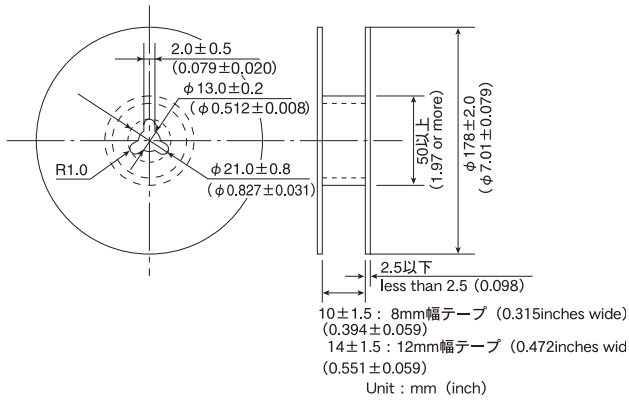

⑥トップテープ強度 Top Tape Strength

トップテープのはがし力は下図矢印方向にて0.1～0.7Nとなります。  
The top tape requires a peel-off force of 0.1～0.7N in the direction of the arrow as illustrated below.

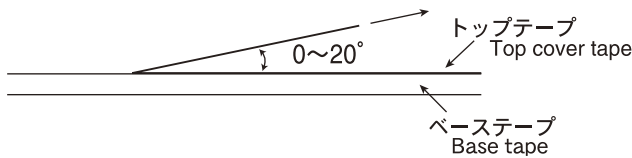

Multilayer Ceramic Capacitor Chips

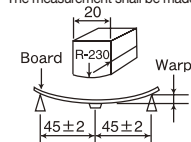
Item	Specified Value				Test Methods and Remarks
	Temperature Compensating (Class 1)		High Permittivity (Class 2)		
	Standard	High Frequency Type	Standard Note1	High Value	
1. Operating Temperature Range	-55 to +125°C		BJ : -55 to +125°C F : -25 to +85°C	-25 to +85°C	High Capacitance Type BJ (X7R) : -55~+125°C, BJ (X5R) : -55~+85°C E (Y5U) : -30~+85°C, F (Y5V) : -30~+85°C
2. Storage Temperature Range	-55 to +125°C		BJ : -55 to +125°C F : -25 to +85°C	-25 to +85°C	High Capacitance Type BJ (X7R) : -55~+125°C, BJ (X5R) : -55~+85°C E (Y5U) : -30~+85°C, F (Y5V) : -30~+85°C
3. Rated Voltage	50VDC, 25VDC, 16VDC	16VDC 50VDC	50VDC, 25VDC	50VDC, 35VDC, 25VDC 16VDC, 10VDC, 6.3VDC 4VDC, 2.5VDC	
4. Withstanding Voltage Between terminals	No breakdown or damage	No abnormality	No breakdown or damage		Applied voltage: Rated voltage × 3 (Class 1) Rated voltage × 2.5 (Class 2) Duration: 1 to 5 sec. Charge/discharge current: 50mA max. (Class 1,2)
5. Insulation Resistance	10000 MΩ min.		500 MΩ μF, or 10000 MΩ., whichever is the smaller. Note 5		Applied voltage: Rated voltage Duration: 60 ± 5 sec. Charge/discharge current: 50mA max.
6. Capacitance (Tolerance)	0.5 to 5 pF : ± 0.25 pF 1 to 10 pF : ± 0.5 pF 5 to 10 pF : ± 1 pF 11 pF or over : ± 5% ± 10% 105TYPE <sup>△</sup> , S <sup>△</sup> , T <sup>△</sup> , U <sup>△</sup> only 0.5~2pF : ± 0.1pF 2.2~20pF : ± 5%	0.5 to 2 pF : ± 0.1 pF 2.2 to 5.1 pF : ± 5%	BJ : ± 10%, ± 20% F : +80% -20%	BJ : ± 10%, ± 20% F : -20% / +80%	Measuring frequency : Class 1 : 1MHz ± 10% (C ≤ 1000pF) 1 k Hz ± 10% (C > 1000pF) Class 2 : 1 k Hz ± 10% (C ≤ 10 μF) 120Hz ± 10Hz (C > 10 μF) Measuring voltage : Note 4 Class 1 : 0.5~5Vrms (C ≤ 1000pF) 1 ± 0.2Vrms (C > 1000pF) Class 2 : 1 ± 0.2Vrms (C ≤ 10 μF) 0.5 ± 0.1Vrms (C > 10 μF) Bias application: None
7. Q or Tangent of Loss Angle (tan δ)	Under 30 pF : Q ≥ 400 + 20C 30 pF or over : Q ≥ 1000 C = Nominal capacitance	Refer to detailed specification	BJ : 2.5% max. (50V, 25V) F : 5.0% max. (50V, 25V) Note 4	BJ : 2.5% max. F : 7% max. Note 4	Multilayer: Measuring frequency : Class 1 : 1MHz ± 10% (C ≤ 1000pF) 1 k Hz ± 10% (C > 1000pF) Class 2 : 1 k Hz ± 10% (C ≤ 10 μF) 120Hz ± 10Hz (C > 10 μF) Measuring voltage : Note 4 Class 1 : 0.5~5Vrms (C ≤ 1000pF) 1 ± 0.2Vrms (C > 1000pF) Class 2 : 1 ± 0.2Vrms (C ≤ 10 μF) 0.5 ± 0.1Vrms (C > 10 μF) Bias application: None High-Frequency-Multilayer: Measuring frequency: 1GHz Measuring equipment: HP4291A Measuring jig: HP16192A
8. Temperature Characteristic of Capacitance	(Without voltage application) CK : 0 ± 250 CJ : 0 ± 120 CH : 0 ± 60 CG : 0 ± 30 RH : -220 ± 60 SK : -330 ± 250 SJ : -330 ± 120 SH : -330 ± 60 TK : -470 ± 250 TJ : -470 ± 120 UK : -750 ± 250 UJ : -750 ± 120 SL : +350 to -1000 (ppm/°C)	CH : 0 ± 60 RH : -220 ± 60 (ppm/°C)	BJ : ± 10% (-25~85°C) F : +30% (-25~85°C) -80 BJ (X7R) : ± 15% F (Y5V) : +22% -82	BJ : ± 10% (-25~+85°C) F : +30% / -80% (-25~+85°C) BJ (X7R, X5R) : ± 15% F (Y5V) : +22% / -82%	According to JIS C 5102 clause 7.12. Temperature compensating: Measurement of capacitance at 20°C and 85°C shall be made to calculate temperature characteristic by the following equation. $\frac{C_{85} - C_{20}}{C_{20} \times \Delta T} \times 10^6 \text{ (ppm/°C)}$ High permittivity: Change of maximum capacitance deviation in step 1 to 5 Temperature at step 1: +20°C Temperature at step 2: minimum operating temperature Temperature at step 3: +20°C (Reference temperature) Temperature at step 4: maximum operating temperature Temperature at step 5: +20°C Reference temperature for X7R, X5R, Y5U and Y5V shall be +25°C
9. Resistance to Flexure of Substrate	Appearance: No abnormality Capacitance change: Within ± 5% or ± 0.5 pF, whichever is larger.	Appearance: No abnormality Capacitance change: Within ± 0.5 pF	Appearance: No abnormality Capacitance change: BJ : Within ± 12.5% F : Within ± 30%		Warp: 1mm Testing board: glass epoxy-resin substrate Thickness: 1.6mm (063 TYPE : 0.8mm) The measurement shall be made with board in the bent position.  (Unit: mm)

Multilayer Ceramic Capacitor Chips

Item	Specified Value				Test Methods and Remarks
	Temperature Compensating (Class 1)		High Permittivity (Class 2)		
	Standard	High Frequency Type	Standard Note1	High Value	
10.Body Strength	—	No mechanical damage.	—	—	High Frequency Multilayer: Applied force: 5N Duration: 10 sec. 
11.Adhesion of Electrode	No separation or indication of separation of electrode.				Applied force: 5N Duration: 30±5 sec. (01005, 0201, 0302 TYPE 2N) 
12.Solderability	At least 95% of terminal electrode is covered by new solder.				Solder temperature: 230±5°C Duration: 4±1 sec.
13.Resistance to soldering	Appearance: No abnormality Capacitance change: Within ±2.5% or ±0.25pF, whichever is larger. Q: Initial value Insulation resistance: Initial value Withstanding voltage (between terminals): No abnormality	Appearance: No abnormality Capacitance change: Within ±2.5% Q: Initial value Insulation resistance: Initial value Withstanding voltage (between terminals): No abnormality	Appearance: No abnormality Capacitance change: Within ±7.5% (BJ) Within ±20% (F) tan δ: Initial value Note 4 Insulation resistance: Initial value Withstanding voltage (between terminals): No abnormality		Preconditioning: Thermal treatment (at 150°C for 1 hr) (Applicable to Class 2.) Solder temperature: 270±5°C Duration: 3±0.5 sec. Preheating conditions: 80 to 100°C, 2 to 5 min. or 5 to 10 min. 150 to 200°C, 2 to 5 min. or 5 to 10 min. Recovery: Recovery for the following period under the standard condition after the test. 6~24 hrs (Class 1) 24±2 hrs (Class 2)
14.Thermal shock	Appearance: No abnormality Capacitance change: Within ±2.5% or ±0.25pF, whichever is larger. Q: Initial value Insulation resistance: Initial value Withstanding voltage (between terminals): No abnormality	Appearance: No abnormality Capacitance change: Within ±0.25pF Q: Initial value Insulation resistance: Initial value Withstanding voltage (between terminals): No abnormality	Appearance: No abnormality Capacitance change: Within ±7.5% (BJ) Within ±20% (F) tan δ: Initial value Note 4 Insulation resistance: Initial value Withstanding voltage (between terminals): No abnormality		Preconditioning: Thermal treatment (at 150°C for 1 hr) (Applicable to Class 2.) Conditions for 1 cycle: Step 1: Minimum operating temperature $+0_{-3}^{\circ}\text{C}$ 30±3 min. Step 2: Room temperature 2 to 3 min. Step 3: Maximum operating temperature $-0_{+3}^{\circ}\text{C}$ 30±3 min. Step 4: Room temperature 2 to 3 min. Number of cycles: 5 times Recovery after the test: 6~24 hrs (Class 1) 24±2 hrs (Class 2)
15.Damp Heat (steady state)	Appearance: No abnormality Capacitance change: Within ±5% or ±0.5pF, whichever is larger. Q: $C \geq 30 \text{ pF} : Q \geq 350$ $10 \leq C < 30 \text{ pF} : Q \geq 275 + 2.5C$ $C < 10 \text{ pF} : Q \geq 200 + 10C$ C: Nominal capacitance Insulation resistance: 1000 MΩ min.	Appearance: No abnormality Capacitance change: Within ±0.5pF, Insulation resistance: 1000 MΩ min.	Appearance: No abnormality Capacitance change: BJ: Within ±12.5% F: Within ±30% tan δ: BJ: 5.0% max. F: 7.5% max. Note 4 Insulation resistance: 50 MΩμF or 1000 MΩ whichever is smaller. Note 5	Appearance: No abnormality Capacitance change: BJ: Within ±12.5% Note 4 tan δ: BJ: 5.0% max. Note 4. F: 11.0% max. Insulation resistance: 50 MΩμF or 1000 MΩ whichever is smaller. Note 5	Multilayer : Preconditioning: Thermal treatment (at 150°C for 1 hr) (Applicable to Class 2.) Temperature: 40±2°C Humidity: 90 to 95% RH Duration: 500 $_{-0}^{+24}$ hrs Recovery: Recovery for the following period under the standard condition after the removal from test chamber. 6~24 hrs (Class 1) 24±2 hrs (Class 2) High-Frequency Multilayer: Temperature: 60±2°C Humidity: 90 to 95% RH Duration: 500 $_{-0}^{+24}$ hrs Recovery: Recovery for the following period under the standard condition after the removal from test chamber. 6~24 hrs (Class 1)

## Multilayer Ceramic Capacitor Chips

Item	Specified Value				Test Methods and Remarks
	Temperature Compensating (Class 1)		High Permittivity (Class 2)		
	Standard	High Frequency Type	Standard Note1	High Value	
16>Loading under Damp Heat	Appearance: No abnormality Capacitance change: Within $\pm 7.5\%$ or $\pm 0.75\text{pF}$ , whichever is larger. Q: $C \geq 30\text{pF}$ : $Q \geq 200$ $C < 30\text{pF}$ : $Q \geq 100 + 10C/3$ C : Nominal capacitance Insulation resistance: 500 M $\Omega$ min.	Appearance: No abnormality Capacitance change: $C \leq 2\text{pF}$ : Within $\pm 0.4\text{pF}$ $C > 2\text{pF}$ : Within $\pm 0.75\text{pF}$ C : Nominal capacitance Insulation resistance: 500 M $\Omega$ min.	Appearance: No abnormality Capacitance change: BJ: Within $\pm 12.5\%$ F: Within $\pm 30\%$ Note 4 tan $\delta$ : BJ: 5.0% max. F: 7.5% max. Note 4 Insulation resistance: 25 M $\Omega$ $\mu\text{F}$ or 500 M $\Omega$ , whichever is the smaller. Note 5	Appearance: No abnormality Capacitance change: BJ : Within $\pm 12.5\%$ F : Within $\pm 30\%$ Note 4 tan $\delta$ : BJ : 5.0% max. F : 11% max. Note 4 Insulation resistance: 25 M $\Omega$ $\mu\text{F}$ or 500 M $\Omega$ , whichever is the smaller. Note 5	According to JIS C 5102 Clause 9. 9. Multilayer: Preconditioning: Voltage treatment (Class 2) Temperature: $40 \pm 2^\circ\text{C}$ Humidity: 90 to 95% RH Duration: $500_{-0}^{+24}$ hrs Applied voltage: Rated voltage Charge and discharge current: 50mA max. (Class 1,2) Recovery: Recovery for the following period under the standard condition after the removal from test chamber. 6~24 hrs (Class 1) 24 $\pm 2$ hrs (Class 2) High-Frequency Multilayer: Temperature: $60 \pm 2^\circ\text{C}$ Humidity: 90 to 95% RH Duration: $500_{-0}^{+24}$ hrs Applied voltage: Rated voltage Charge and discharge current: 50mA max. Recovery: 6~24 hrs of recovery under the standard condition after the removal from test chamber.
17>Loading at High Temperature	Appearance: No abnormality Capacitance change: Within $\pm 3\%$ or $\pm 0.3\text{pF}$ , whichever is larger. Q: $C \geq 30\text{pF}$ : $Q \geq 350$ $10 \leq C < 30\text{pF}$ : $Q \geq 275 + 2.5C$ $C < 10\text{pF}$ : $Q \geq 200 + 10C$ C : Nominal capacitance Insulation resistance: 1000 M $\Omega$ min.	Appearance: No abnormality Capacitance change: Within $\pm 3\%$ or $\pm 0.3\text{pF}$ , whichever is larger. Insulation resistance: 1000 M $\Omega$ min.	Appearance: No abnormality Capacitance change: BJ: Within $\pm 12.5\%$ F: Within $\pm 30\%$ Note 4 tan $\delta$ : BJ: 4.0% max. F: 7.5% max. Note 4 Insulation resistance: 50 M $\Omega$ $\mu\text{F}$ or 1000 M $\Omega$ , whichever is smaller. Note 5	Appearance: No abnormality Capacitance change: BJ : Within $\pm 12.5\%$ Within $\pm 20\% \ast \ast$ Within $\pm 25\% \ast \ast$ F : Within $\pm 30\%$ Note 4 tan $\delta$ : BJ : 5.0% max. F : 11% max. Note 4 Insulation resistance: 50 M $\Omega$ $\mu\text{F}$ or 1000 M $\Omega$ , whichever is smaller. Note 5	According to JIS C 5102 clause 9.10. Multilayer: Preconditioning: Voltage treatment (Class 2) Temperature: $125 \pm 3^\circ\text{C}$ (Class 1, Class 2: B, BJ (X7R)) $85 \pm 2^\circ\text{C}$ (Class 2: BJ,F) Duration: $1000_{-0}^{+48}$ hrs Applied voltage: Rated voltage $\times 2$ Note 6 Recovery: Recovery for the following period under the standard condition after the removal from test chamber. 6~24 hrs (Class 1) 24 $\pm 2$ hrs (Class 2) High-Frequency Multilayer: Temperature: $125 \pm 3^\circ\text{C}$ (Class 1) Duration: $1000_{-0}^{+48}$ hrs Applied voltage: Rated voltage $\times 2$ Recovery: 6~24 hrs of recovery under the standard condition after the removal from test chamber.

Note 1 :For 105 type, specified in "High value".

Note 2 :Thermal treatment (Multilayer): 1 hr of thermal treatment at  $150 \pm 0 / -10^\circ\text{C}$  followed by  $24 \pm 2$  hrs of recovery under the standard condition shall be performed before the measurement.

Note 3 :Voltage treatment (Multilayer): 1 hr of voltage treatment under the specified temperature and voltage for testing followed by  $24 \pm 2$  hrs of recovery under the standard condition shall be performed before the measurement.

Note 4, 5 :The figure indicates typical inspection. Please refer to individual specifications.

Note 6 :Some of the parts are applicable in rated voltage  $\times 1.5$ . Please refer to individual specifications.





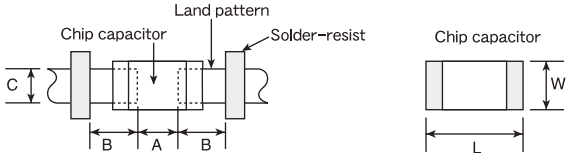
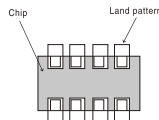
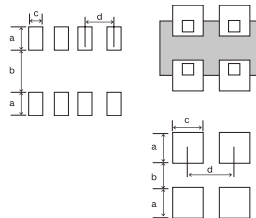

Note on standard condition: "standard condition" referred to herein is defined as follows: 5 to  $35^\circ\text{C}$  of temperature, 45 to 85% relative humidity, and 86 to 106kPa of air pressure.

When there are questions concerning measurement results: In order to provide correlation data, the test shall be conducted under condition of  $20 \pm 2^\circ\text{C}$  of temperature, 60 to 70% relative humidity, and 86 to 106kPa of air pressure. Unless otherwise specified, all the tests are conducted under the "standard condition."

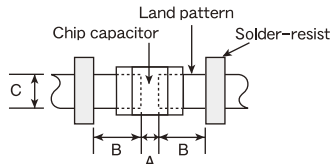
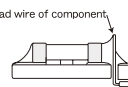
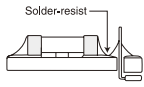
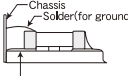
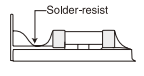
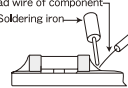
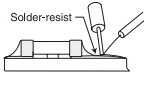
Precautions on the use of Multilayer Ceramic Capacitors

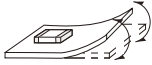
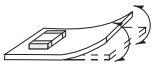
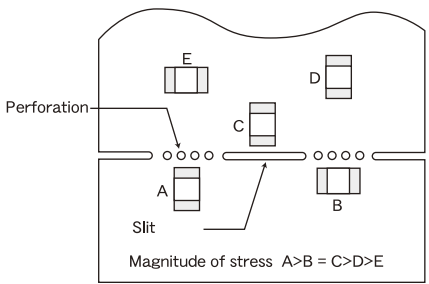
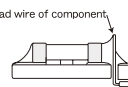
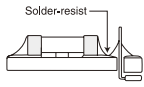
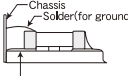
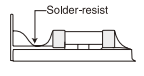
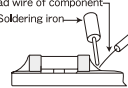
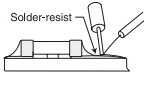
Stages	Precautions	Technical considerations																																																																																																																																		
1.Circuit Design	<p>Verification of operating environment, electrical rating and performance</p> <p>1. A malfunction in medical equipment, spacecraft, nuclear reactors, etc. may cause serious harm to human life or have severe social ramifications. As such, any capacitors to be used in such equipment may require higher safety and/or reliability considerations and should be clearly differentiated from components used in general purpose applications.</p> <p>Operating Voltage (Verification of Rated voltage)</p> <p>1. The operating voltage for capacitors must always be lower than their rated values.</p> <p>If an AC voltage is loaded on a DC voltage, the sum of the two peak voltages should be lower than the rated value of the capacitor chosen. For a circuit where both an AC and a pulse voltage may be present, the sum of their peak voltages should also be lower than the capacitor's rated voltage.</p> <p>2. Even if the applied voltage is lower than the rated value, the reliability of capacitors might be reduced if either a high frequency AC voltage or a pulse voltage having rapid rise time is present in the circuit.</p>																																																																																																																																			
2.PCB Design	<p>Pattern configurations (Design of Land-patterns)</p> <p>1. When capacitors are mounted on a PCB, the amount of solder used (size of fillet) can directly affect capacitor performance. Therefore, the following items must be carefully considered in the design of solder land patterns:</p> <p>(1) The amount of solder applied can affect the ability of chips to withstand mechanical stresses which may lead to breaking or cracking. Therefore, when designing land-patterns it is necessary to consider the appropriate size and configuration of the solder pads which in turn determines the amount of solder necessary to form the fillets.</p> <p>(2) When more than one part is jointly soldered onto the same land or pad, the pad must be designed so that each component's soldering point is separated by solder-resist.</p>	<p>1.The following diagrams and tables show some examples of recommended patterns to prevent excessive solder amounts. (larger fillets which extend above the component end terminations)</p> <p>Examples of improper pattern designs are also shown.</p> <p>(1) Recommended land dimensions for a typical chip capacitor land patterns for PCBs</p>  <p>Recommended land dimensions for wave-soldering (unit: mm)</p> <table border="1" data-bbox="849 1255 1230 1437"> <thead> <tr> <th>Type</th> <th>107</th> <th>212</th> <th>316</th> <th>325</th> </tr> </thead> <tbody> <tr> <td rowspan="2">Size</td> <td>L</td> <td>1.6</td> <td>2.0</td> <td>3.2</td> <td>3.2</td> </tr> <tr> <td>W</td> <td>0.8</td> <td>1.25</td> <td>1.6</td> <td>2.5</td> </tr> <tr> <td>A</td> <td>0.8~1.0</td> <td>1.0~1.4</td> <td>1.8~2.5</td> <td>1.8~2.5</td> </tr> <tr> <td>B</td> <td>0.5~0.8</td> <td>0.8~1.5</td> <td>0.8~1.7</td> <td>0.8~1.7</td> </tr> <tr> <td>C</td> <td>0.6~0.8</td> <td>0.9~1.2</td> <td>1.2~1.6</td> <td>1.8~2.5</td> </tr> </tbody> </table> <p>Recommended land dimensions for reflow-soldering (unit: mm)</p> <table border="1" data-bbox="849 1502 1453 1683"> <thead> <tr> <th>Type</th> <th>042</th> <th>063</th> <th>105</th> <th>107</th> <th>212</th> <th>316</th> <th>325</th> <th>432</th> </tr> </thead> <tbody> <tr> <td rowspan="2">Size</td> <td>L</td> <td>0.4</td> <td>0.6</td> <td>1.0</td> <td>1.6</td> <td>2.0</td> <td>3.2</td> <td>3.2</td> <td>4.5</td> </tr> <tr> <td>W</td> <td>0.2</td> <td>0.3</td> <td>0.5</td> <td>0.8</td> <td>1.25</td> <td>1.6</td> <td>2.5</td> <td>3.2</td> </tr> <tr> <td>A</td> <td>0.15~0.25</td> <td>0.20~0.30</td> <td>0.45~0.55</td> <td>0.8~1.0</td> <td>0.8~1.2</td> <td>1.8~2.5</td> <td>1.8~2.5</td> <td>2.5~3.5</td> </tr> <tr> <td>B</td> <td>0.10~0.20</td> <td>0.20~0.30</td> <td>0.40~0.50</td> <td>0.6~0.8</td> <td>0.8~1.2</td> <td>1.0~1.5</td> <td>1.0~1.5</td> <td>1.5~1.8</td> </tr> <tr> <td>C</td> <td>0.15~0.30</td> <td>0.25~0.40</td> <td>0.45~0.55</td> <td>0.6~0.8</td> <td>0.9~1.6</td> <td>1.2~2.0</td> <td>1.8~3.2</td> <td>2.3~3.5</td> </tr> </tbody> </table> <p>Excess solder can affect the ability of chips to withstand mechanical stresses. Therefore, please take proper precautions when designing land-patterns.</p> <table border="1" data-bbox="849 1758 1002 1924"> <thead> <tr> <th>Type</th> <th>212 (4 circuits)</th> </tr> </thead> <tbody> <tr> <td rowspan="2">Size</td> <td>L</td> <td>2.0</td> </tr> <tr> <td>W</td> <td>1.25</td> </tr> <tr> <td>a</td> <td>0.5~0.6</td> </tr> <tr> <td>b</td> <td>0.5~0.6</td> </tr> <tr> <td>c</td> <td>0.2~0.3</td> </tr> <tr> <td>d</td> <td>0.5</td> </tr> </tbody> </table>  <table border="1" data-bbox="849 1939 1182 2107"> <thead> <tr> <th>Type</th> <th>212 (2 circuits)</th> <th>110 (2 circuits)</th> <th>096 (2 circuits)</th> </tr> </thead> <tbody> <tr> <td rowspan="2">Size</td> <td>L</td> <td>2.0</td> <td>1.37</td> <td>0.9</td> </tr> <tr> <td>W</td> <td>1.25</td> <td>1.0</td> <td>0.6</td> </tr> <tr> <td>a</td> <td>0.5~0.6</td> <td>0.35~0.45</td> <td>0.25~0.35</td> </tr> <tr> <td>b</td> <td>0.5~0.6</td> <td>0.55~0.65</td> <td>0.15~0.25</td> </tr> <tr> <td>c</td> <td>0.5~0.6</td> <td>0.3~0.4</td> <td>0.15~0.25</td> </tr> <tr> <td>d</td> <td>1.0</td> <td>0.64</td> <td>0.45</td> </tr> </tbody> </table> 	Type	107	212	316	325	Size	L	1.6	2.0	3.2	3.2	W	0.8	1.25	1.6	2.5	A	0.8~1.0	1.0~1.4	1.8~2.5	1.8~2.5	B	0.5~0.8	0.8~1.5	0.8~1.7	0.8~1.7	C	0.6~0.8	0.9~1.2	1.2~1.6	1.8~2.5	Type	042	063	105	107	212	316	325	432	Size	L	0.4	0.6	1.0	1.6	2.0	3.2	3.2	4.5	W	0.2	0.3	0.5	0.8	1.25	1.6	2.5	3.2	A	0.15~0.25	0.20~0.30	0.45~0.55	0.8~1.0	0.8~1.2	1.8~2.5	1.8~2.5	2.5~3.5	B	0.10~0.20	0.20~0.30	0.40~0.50	0.6~0.8	0.8~1.2	1.0~1.5	1.0~1.5	1.5~1.8	C	0.15~0.30	0.25~0.40	0.45~0.55	0.6~0.8	0.9~1.6	1.2~2.0	1.8~3.2	2.3~3.5	Type	212 (4 circuits)	Size	L	2.0	W	1.25	a	0.5~0.6	b	0.5~0.6	c	0.2~0.3	d	0.5	Type	212 (2 circuits)	110 (2 circuits)	096 (2 circuits)	Size	L	2.0	1.37	0.9	W	1.25	1.0	0.6	a	0.5~0.6	0.35~0.45	0.25~0.35	b	0.5~0.6	0.55~0.65	0.15~0.25	c	0.5~0.6	0.3~0.4	0.15~0.25	d	1.0	0.64	0.45
Type	107	212	316	325																																																																																																																																
Size	L	1.6	2.0	3.2	3.2																																																																																																																															
	W	0.8	1.25	1.6	2.5																																																																																																																															
A	0.8~1.0	1.0~1.4	1.8~2.5	1.8~2.5																																																																																																																																
B	0.5~0.8	0.8~1.5	0.8~1.7	0.8~1.7																																																																																																																																
C	0.6~0.8	0.9~1.2	1.2~1.6	1.8~2.5																																																																																																																																
Type	042	063	105	107	212	316	325	432																																																																																																																												
Size	L	0.4	0.6	1.0	1.6	2.0	3.2	3.2	4.5																																																																																																																											
	W	0.2	0.3	0.5	0.8	1.25	1.6	2.5	3.2																																																																																																																											
A	0.15~0.25	0.20~0.30	0.45~0.55	0.8~1.0	0.8~1.2	1.8~2.5	1.8~2.5	2.5~3.5																																																																																																																												
B	0.10~0.20	0.20~0.30	0.40~0.50	0.6~0.8	0.8~1.2	1.0~1.5	1.0~1.5	1.5~1.8																																																																																																																												
C	0.15~0.30	0.25~0.40	0.45~0.55	0.6~0.8	0.9~1.6	1.2~2.0	1.8~3.2	2.3~3.5																																																																																																																												
Type	212 (4 circuits)																																																																																																																																			
Size	L	2.0																																																																																																																																		
	W	1.25																																																																																																																																		
a	0.5~0.6																																																																																																																																			
b	0.5~0.6																																																																																																																																			
c	0.2~0.3																																																																																																																																			
d	0.5																																																																																																																																			
Type	212 (2 circuits)	110 (2 circuits)	096 (2 circuits)																																																																																																																																	
Size	L	2.0	1.37	0.9																																																																																																																																
	W	1.25	1.0	0.6																																																																																																																																
a	0.5~0.6	0.35~0.45	0.25~0.35																																																																																																																																	
b	0.5~0.6	0.55~0.65	0.15~0.25																																																																																																																																	
c	0.5~0.6	0.3~0.4	0.15~0.25																																																																																																																																	
d	1.0	0.64	0.45																																																																																																																																	

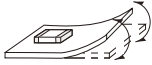
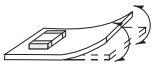
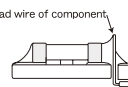
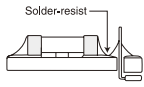
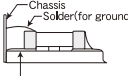
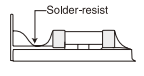
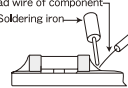
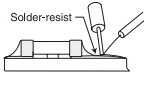
Precautions on the use of Multilayer Ceramic Capacitors

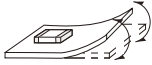
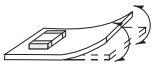
Stages	Precautions	Technical considerations																																														
<p>2.PCB Design</p>	<p>Pattern configurations (Capacitor layout on panelized [breakaway] PC boards)</p> <p>1. After capacitors have been mounted on the boards, chips can be subjected to mechanical stresses in subsequent manufacturing processes (PCB cutting, board inspection, mounting of additional parts, assembly into the chassis, wave soldering the reflow soldered boards etc.) For this reason, planning pattern configurations and the position of SMD capacitors should be carefully performed to minimize stress.</p>	<p>LWDC Recommended land dimensions for reflow-soldering</p>  <table border="1" data-bbox="853 469 1157 655"> <thead> <tr> <th>Type</th> <th>105</th> <th>107</th> <th>212</th> </tr> </thead> <tbody> <tr> <td rowspan="2">Size</td> <td>L</td> <td>0.52</td> <td>0.8</td> <td>1.25</td> </tr> <tr> <td>W</td> <td>1.0</td> <td>1.6</td> <td>2.0</td> </tr> <tr> <td>A</td> <td>0.18~0.22</td> <td>0.25~0.3</td> <td>0.5~0.7</td> </tr> <tr> <td>B</td> <td>0.2~0.25</td> <td>0.3~0.4</td> <td>0.4~0.5</td> </tr> <tr> <td>C</td> <td>0.9~1.1</td> <td>1.5~1.7</td> <td>1.9~2.1</td> </tr> </tbody> </table> <p>(unit: mm)</p> <p>(2) Examples of good and bad solder application</p> <table border="1" data-bbox="845 753 1444 1190"> <thead> <tr> <th>Items</th> <th>Not recommended</th> <th>Recommended</th> </tr> </thead> <tbody> <tr> <td>Mixed mounting of SMD and leaded components</td> <td></td> <td></td> </tr> <tr> <td>Component placement close to the chassis</td> <td></td> <td></td> </tr> <tr> <td>Hand-soldering of leaded components near mounted components</td> <td></td> <td></td> </tr> <tr> <td>Horizontal component placement</td> <td></td> <td></td> </tr> </tbody> </table> <p>1-1. The following are examples of good and bad capacitor layout; SMD capacitors should be located to minimize any possible mechanical stresses from board warp or deflection.</p> <table border="1" data-bbox="845 1299 1444 1452"> <thead> <tr> <th></th> <th>Not recommended</th> <th>Recommended</th> </tr> </thead> <tbody> <tr> <td>Deflection of the board</td> <td></td> <td></td> </tr> </tbody> </table> <p>1-2. To layout the capacitors for the breakaway PC board, it should be noted that the amount of mechanical stresses given will vary depending on capacitor layout. The example below shows recommendations for better design.</p>  <p>Magnitude of stress <math>A &gt; B = C &gt; D &gt; E</math></p> <p>1-3. When breaking PC boards along their perforations, the amount of mechanical stress on the capacitors can vary according to the method used. The following methods are listed in order from least stressful to most stressful: push-back, slit, V-grooving, and perforation. Thus, any ideal SMD capacitor layout must also consider the PCB splitting procedure.</p>	Type	105	107	212	Size	L	0.52	0.8	1.25	W	1.0	1.6	2.0	A	0.18~0.22	0.25~0.3	0.5~0.7	B	0.2~0.25	0.3~0.4	0.4~0.5	C	0.9~1.1	1.5~1.7	1.9~2.1	Items	Not recommended	Recommended	Mixed mounting of SMD and leaded components			Component placement close to the chassis			Hand-soldering of leaded components near mounted components			Horizontal component placement				Not recommended	Recommended	Deflection of the board		
Type	105	107	212																																													
Size	L	0.52	0.8	1.25																																												
	W	1.0	1.6	2.0																																												
A	0.18~0.22	0.25~0.3	0.5~0.7																																													
B	0.2~0.25	0.3~0.4	0.4~0.5																																													
C	0.9~1.1	1.5~1.7	1.9~2.1																																													
Items	Not recommended	Recommended																																														
Mixed mounting of SMD and leaded components																																																
Component placement close to the chassis																																																
Hand-soldering of leaded components near mounted components																																																
Horizontal component placement																																																
	Not recommended	Recommended																																														
Deflection of the board																																																

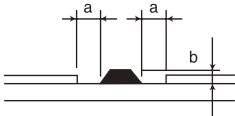
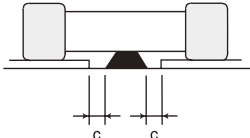

Precautions on the use of Multilayer Ceramic Capacitors

Stages	Precautions	Technical considerations																	
<p>3.Considerations for auto-automatic placement</p>	<p>Adjustment of mounting machine</p> <ol style="list-style-type: none"> <li>Excessive impact load should not be imposed on the capacitors when mounting onto the PC boards.</li> <li>The maintenance and inspection of the mounters should be conducted periodically.</li> </ol> <p>Selection of Adhesives</p> <ol style="list-style-type: none"> <li>Mounting capacitors with adhesives in preliminary assembly, before the soldering stage, may lead to degraded capacitor characteristics unless the following factors are appropriately checked; the size of land patterns, type of adhesive, amount applied, hardening temperature and hardening period. Therefore, it is imperative to consult the manufacturer of the adhesives on proper usage and amounts of adhesive to use.</li> </ol>	<ol style="list-style-type: none"> <li>If the lower limit of the pick-up nozzle is low, too much force may be imposed on the capacitors, causing damage. To avoid this, the following points should be considered before lowering the pick-up nozzle:                     <ol style="list-style-type: none"> <li>The lower limit of the pick-up nozzle should be adjusted to the surface level of the PC board after correcting for deflection of the board.</li> <li>The pick-up pressure should be adjusted between 1 and 3 N static loads.</li> <li>To reduce the amount of deflection of the board caused by impact of the pick-up nozzle, supporting pins or back-up pins should be used under the PC board. The following diagrams show some typical examples of good pick-up nozzle placement:</li> </ol> </li> </ol> <table border="1" data-bbox="850 526 1449 794"> <thead> <tr> <th></th> <th>Not recommended</th> <th>Recommended</th> </tr> </thead> <tbody> <tr> <td>Single-sided mounting</td> <td></td> <td></td> </tr> <tr> <td>Double-sided mounting</td> <td></td> <td></td> </tr> </tbody> </table> <ol style="list-style-type: none"> <li>As the alignment pin wears out, adjustment of the nozzle height can cause chipping or cracking of the capacitors because of mechanical impact on the capacitors. To avoid this, the monitoring of the width between the alignment pin in the stopped position, and maintenance, inspection and replacement of the pin should be conducted periodically.</li> </ol> <ol style="list-style-type: none"> <li>Some adhesives may cause reduced insulation resistance. The difference between the shrinkage percentage of the adhesive and that of the capacitors may result in stresses on the capacitors and lead to cracking. Moreover, too little or too much adhesive applied to the board may adversely affect component placement, so the following precautions should be noted in the application of adhesives.                     <ol style="list-style-type: none"> <li>Required adhesive characteristics                             <ol style="list-style-type: none"> <li>The adhesive should be strong enough to hold parts on the board during the mounting &amp; solder process.</li> <li>The adhesive should have sufficient strength at high temperatures.</li> <li>The adhesive should have good coating and thickness consistency.</li> <li>The adhesive should be used during its prescribed shelf life.</li> <li>The adhesive should harden rapidly</li> <li>The adhesive must not be contaminated.</li> <li>The adhesive should have excellent insulation characteristics.</li> <li>The adhesive should not be toxic and have no emission of toxic gasses.</li> </ol> </li> <li>The recommended amount of adhesives is as follows;                             <table border="1" data-bbox="850 1469 1404 1589"> <thead> <tr> <th>Figure</th> <th>212/316 case sizes as examples</th> </tr> </thead> <tbody> <tr> <td>a</td> <td>0.3mm min</td> </tr> <tr> <td>b</td> <td>100 ~ 120 μm</td> </tr> <tr> <td>c</td> <td>Adhesives should not contact the pad</td> </tr> </tbody> </table> </li> </ol> </li> </ol> <div style="display: flex; justify-content: space-around; margin-top: 20px;"> <div data-bbox="874 1662 1109 1808"> <p>Amount of adhesive</p>  </div> <div data-bbox="1173 1662 1423 1852"> <p>After capacitors are bonded</p>  </div> </div>		Not recommended	Recommended	Single-sided mounting			Double-sided mounting			Figure	212/316 case sizes as examples	a	0.3mm min	b	100 ~ 120 μm	c	Adhesives should not contact the pad
	Not recommended	Recommended																	
Single-sided mounting																			
Double-sided mounting																			
Figure	212/316 case sizes as examples																		
a	0.3mm min																		
b	100 ~ 120 μm																		
c	Adhesives should not contact the pad																		

Precautions on the use of Multilayer Ceramic Capacitors

Stages	Precautions	Technical considerations
4. Soldering	<p><b>Selection of Flux</b></p> <p>1. Since flux may have a significant effect on the performance of capacitors, it is necessary to verify the following conditions prior to use;</p> <p>(1) Flux used should be with less than or equal to 0.1 wt% (equivalent to chlorine) of halogenated content. Flux having a strong acidity content should not be applied.</p> <p>(2) When soldering capacitors on the board, the amount of flux applied should be controlled at the optimum level.</p> <p>(3) When using water-soluble flux, special care should be taken to properly clean the boards.</p> <p><b>Soldering</b></p> <p>Temperature, time, amount of solder, etc. are specified in accordance with the following recommended conditions.</p> <p>Sn-Zn solder paste can affect MLCC reliability performance. Please contact us prior to usage.</p>	<p>1-1. When too much halogenated substance (Chlorine, etc.) content is used to activate the flux, or highly acidic flux is used, an excessive amount of residue after soldering may lead to corrosion of the terminal electrodes or degradation of insulation resistance on the surface of the capacitors.</p> <p>1-2. Flux is used to increase solderability in flow soldering, but if too much is applied, a large amount of flux gas may be emitted and may detrimentally affect solderability. To minimize the amount of flux applied, it is recommended to use a flux-bubbling system.</p> <p>1-3. Since the residue of water-soluble flux is easily dissolved by water content in the air, the residue on the surface of capacitors in high humidity conditions may cause a degradation of insulation resistance and therefore affect the reliability of the components. The cleaning methods and the capability of the machines used should also be considered carefully when selecting water-soluble flux.</p> <p>1-1. Preheating when soldering</p> <p>Heating: Ceramic chip components should be preheated to within 100 to 130°C of the soldering.</p> <p>Cooling: The temperature difference between the components and cleaning process should not be greater than 100°C.</p> <p>Ceramic chip capacitors are susceptible to thermal shock when exposed to rapid or concentrated heating or rapid cooling. Therefore, the soldering process must be conducted with great care so as to prevent malfunction of the components due to excessive thermal shock.</p> <p><b>Recommended conditions for soldering</b></p> <p>[Reflow soldering]</p> <p>Temperature profile</p>   <p>Caution</p> <p>1. The ideal condition is to have solder mass (fillet) controlled to 1/2 to 1/3 of the thickness of the capacitor, as shown below:</p>  <p>2. Because excessive dwell times can detrimentally affect solderability, soldering duration should be kept as close to recommended times as possible.</p> <p>[Wave soldering]</p> <p>Temperature profile</p>   <p>Caution</p> <p>1. Make sure the capacitors are preheated sufficiently.</p> <p>2. The temperature difference between the capacitor and melted solder should not be greater than 100 to 130°C</p> <p>3. Cooling after soldering should be as gradual as possible.</p> <p>4. Wave soldering must not be applied to the capacitors designated as for reflow soldering only.</p>

Precautions on the use of Multilayer Ceramic Capacitors

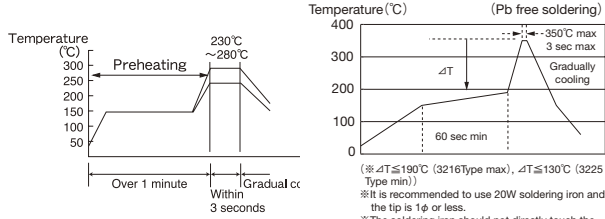
Stages	Precautions	Technical considerations
4. Soldering		<p>[Hand soldering]</p> <p>Temperature profile</p>  <p>Caution</p> <ol style="list-style-type: none"> <li>1. Use a 20W soldering iron with a maximum tip diameter of 1.0 mm.</li> <li>2. The soldering iron should not directly touch the capacitor.</li> </ol>
5. Cleaning	<p>Cleaning conditions</p> <ol style="list-style-type: none"> <li>1. When cleaning the PC board after the capacitors are all mounted, select the appropriate cleaning solution according to the type of flux used and purpose of the cleaning (e.g. to remove soldering flux or other materials from the production process.)</li> <li>2. Cleaning conditions should be determined after verifying, through a test run, that the cleaning process does not affect the capacitor's characteristics.</li> </ol>	<ol style="list-style-type: none"> <li>1. The use of inappropriate solutions can cause foreign substances such as flux residue to adhere to the capacitor or deteriorate the capacitor's outer coating, resulting in a degradation of the capacitor's electrical properties (especially insulation resistance).</li> <li>2. Inappropriate cleaning conditions (insufficient or excessive cleaning) may detrimentally affect the performance of the capacitors.</li> </ol> <p>(1) Excessive cleaning</p> <p>In the case of ultrasonic cleaning, too much power output can cause excessive vibration of the PC board which may lead to the cracking of the capacitor or the soldered portion, or decrease the terminal electrodes' strength. Thus the following conditions should be carefully checked;</p> <p>Ultrasonic output      Below 20 W/ℓ          Ultrasonic frequency      Below 40 kHz          Ultrasonic washing period      5 min. or less</p>
6. Post cleaning processes	<ol style="list-style-type: none"> <li>1. With some type of resins a decomposition gas or chemical reaction vapor may remain inside the resin during the hardening period or while left under normal storage conditions resulting in the deterioration of the capacitor's performance.</li> <li>2. When a resin's hardening temperature is higher than the capacitor's operating temperature, the stresses generated by the excess heat may lead to capacitor damage or destruction. The use of such resins, molding materials etc. is not recommended.</li> </ol>	
7. Handling	<p>Breakaway PC boards (splitting along perforations)</p> <ol style="list-style-type: none"> <li>1. When splitting the PC board after mounting capacitors and other components, care is required so as not to give any stresses of deflection or twisting to the board.</li> <li>2. Board separation should not be done manually, but by using the appropriate devices.</li> </ol> <p>Mechanical considerations</p> <ol style="list-style-type: none"> <li>1. Be careful not to subject the capacitors to excessive mechanical shocks.                     <ol style="list-style-type: none"> <li>(1) If ceramic capacitors are dropped onto the floor or a hard surface, they should not be used.</li> <li>(2) When handling the mounted boards, be careful that the mounted components do not come in contact with or bump against other boards or components.</li> </ol> </li> </ol>	

## Precautions on the use of Multilayer Ceramic Capacitors

Stages	Precautions	Technical considerations
8.Storage conditions	<p>Storage</p> <p>1. To maintain the solderability of terminal electrodes and to keep the packaging material in good condition, care must be taken to control temperature and humidity in the storage area. Humidity should especially be kept as low as possible.</p> <ul style="list-style-type: none"> <li>• Recommended conditions <ul style="list-style-type: none"> <li>Ambient temperature      Below 30°C</li> <li>Humidity                      Below 70% RH</li> </ul> </li> </ul> <p>The ambient temperature must be kept below 40°C. Even under ideal storage conditions capacitor electrode solderability decreases as time passes, so should be used within 6 months from the time of delivery.</p> <ul style="list-style-type: none"> <li>• Ceramic chip capacitors should be kept where no chlorine or sulfur exists in the air.</li> </ul> <p>2. The capacitance value of high dielectric constant capacitors (type 2 &amp;3) will gradually decrease with the passage of time, so this should be taken into consideration in the circuit design. If such a capacitance reduction occurs, a heat treatment of 150°C for 1hour will return the capacitance to its initial level.</p>	<p>1. If the parts are stored in a high temperature and humidity environment, problems such as reduced solderability caused by oxidation of terminal electrodes and deterioration of taping/package materials may take place. For this reason, components should be used within 6 months from the time of delivery. If exceeding the above period, please check solderability before using the capacitors.</p>