

阅读申明

- 1.本站收集的数据手册和产品资料都来自互联网，版权归原作者所有。如读者和版权方有任何异议请及时告之，我们将妥善解决。
- 2.本站提供的中文数据手册是英文数据手册的中文翻译，其目的是协助用户阅读，该译文无法自动跟随原稿更新，同时也可能存在翻译上的不当。建议读者以英文原稿为参考以便获得更精准的信息。
- 3.本站提供的产品资料，来自厂商的技术支持或者使用者的心得体会等，其内容可能存在描述上的差异，建议读者做出适当判断。
- 4.如需与我们联系，请发邮件到marketing@iczoom.com，主题请标有“数据手册”字样。

Read Statement

1. The datasheets and other product information on the site are all from network reference or other public materials, and the copyright belongs to the original author and original published source. If readers and copyright owners have any objections, please contact us and we will deal with it in a timely manner.
2. The Chinese datasheets provided on the website is a Chinese translation of the English datasheets. Its purpose is for reader's learning exchange only and do not involve commercial purposes. The translation cannot be automatically updated with the original manuscript, and there may also be improper translations. Readers are advised to use the English manuscript as a reference for more accurate information.
3. All product information provided on the website refer to solutions from manufacturers' technical support or users the contents may have differences in description, and readers are advised to take the original article as the standard.
4. If you have any questions, please contact us at marketing@iczoom.com and mark the subject with "Datasheets" .

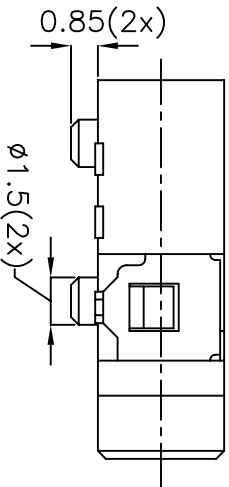
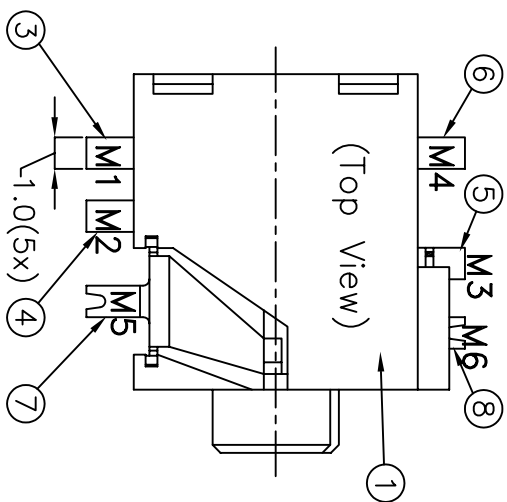

Specifications
 Rated Voltage: 16VDC
 Rated Current: 300mA
 Contact Resistance: 100 mOHMS or less under all conditions including after life testing.
 Insulation Resistance: 100 M OHMS or greater at 500VDC
 Voltage: 250V AC RMS for 1 Minute
 Life: 5,000 cycles min.

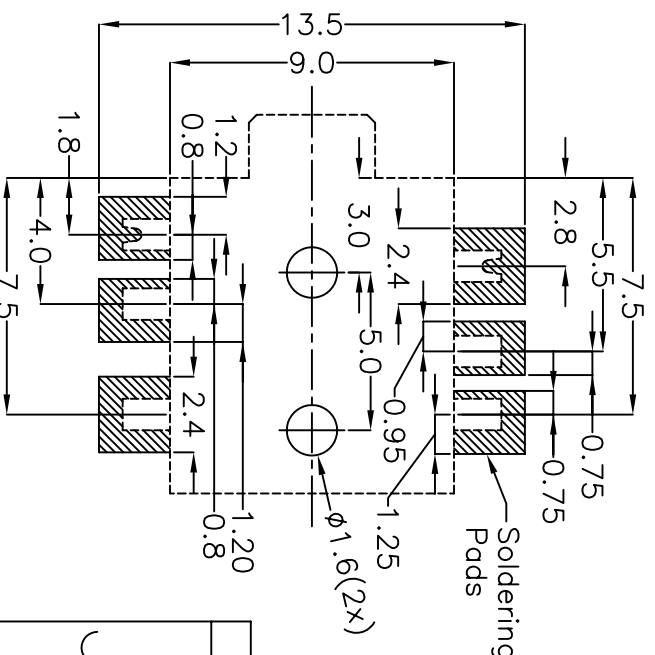
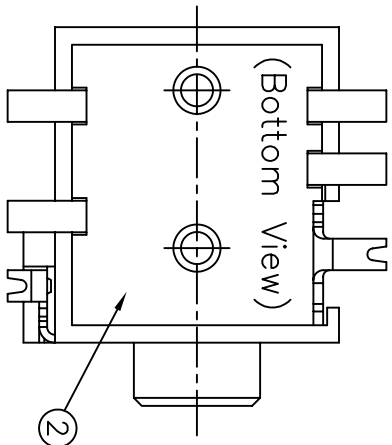
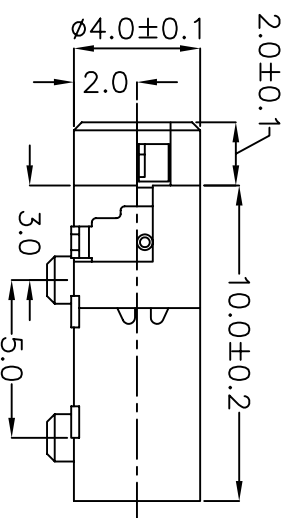
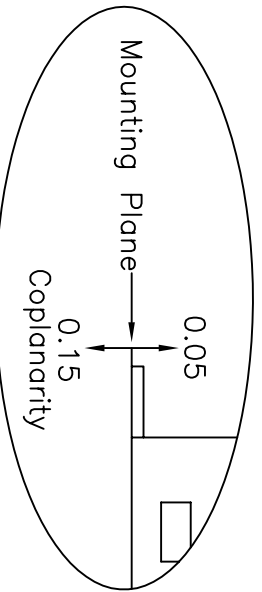
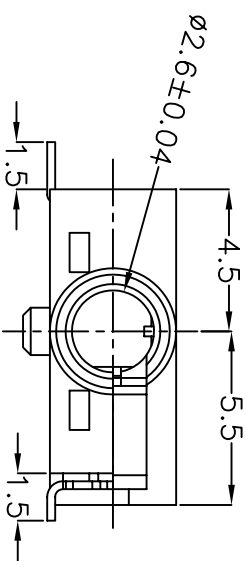

Pad Layout
 Top View

8	Ground <M6>	PBS		Gold Flash 30T
7	Signal <M5>	PBS		Gold Flash 30T
6	Tip Contact <M4>	Ti-Cu Alloy		Gold Flash 20T
5	Shunt (Tip) <M3>	Brass		Gold Flash 30T
4	Shunt (Ring) <M2>	Brass		Gold Flash 30T
3	Ring Contact <M1>	Ti-Cu Alloy		Gold Flash 20T
2	Cover	PY6T	Black	UL94V-0 Rated
1	Plastic Housing <P1>	Polyamide	Black	UL94V-0 Rated
lm	Term	Material	Color	Plating Remark

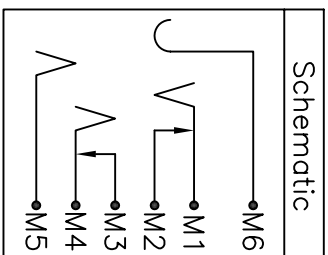

9615 SW Allen, Suite 103
 Beaverton, OR 97005
 Phone: (503) 643-4899
 (800)-275-4899
 Fax: (503) 372-1266
 Website: www.cui.com



TITLE: SMT Audio Jack w/4 Conductors 2.5mm

PART NO. SJ-42516-SMT
 DRAWN BY: Todd R. White
 APPROVED BY:
 UNITS: Millimeters
 SCALE: 4x