

阅读申明

- 1.本站收集的数据手册和产品资料都来自互联网，版权归原作者所有。如读者和版权方有任何异议请及时告之，我们将妥善解决。
- 2.本站提供的中文数据手册是英文数据手册的中文翻译，其目的是协助用户阅读，该译文无法自动跟随原稿更新，同时也可能存在翻译上的不当。建议读者以英文原稿为参考以便获得更精准的信息。
- 3.本站提供的产品资料，来自厂商的技术支持或者使用者的心得体会等，其内容可能存在描述上的差异，建议读者做出适当判断。
- 4.如需与我们联系，请发邮件到marketing@iczoom.com，主题请标有“数据手册”字样。

Read Statement

1. The datasheets and other product information on the site are all from network reference or other public materials, and the copyright belongs to the original author and original published source. If readers and copyright owners have any objections, please contact us and we will deal with it in a timely manner.
2. The Chinese datasheets provided on the website is a Chinese translation of the English datasheets. Its purpose is for reader's learning exchange only and do not involve commercial purposes. The translation cannot be automatically updated with the original manuscript, and there may also be improper translations. Readers are advised to use the English manuscript as a reference for more accurate information.
3. All product information provided on the website refer to solutions from manufacturers' technical support or users the contents may have differences in description, and readers are advised to take the original article as the standard.
4. If you have any questions, please contact us at marketing@iczoom.com and mark the subject with "Datasheets" .

Chip Monolithic Ceramic Capacitors

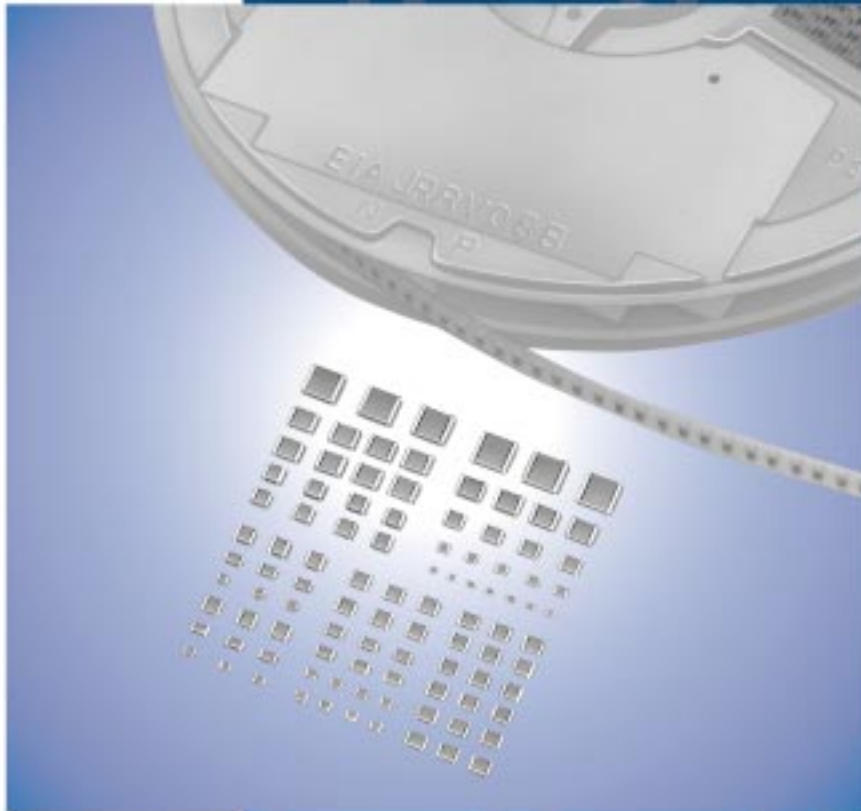

CONTENTS

| | | |
|----------------|-------|---|
| Part Numbering | _____ | 2 |
|----------------|-------|---|

| | | |
|-----------------|-------|---|
| Selection Guide | _____ | 6 |
|-----------------|-------|---|

Chip Monolithic Ceramic Capacitors

| | | | |
|----------|--|-------|-----|
| 1 | For General Purpose GRM Series | _____ | 8 |
| | Specifications and Test Methods | _____ | 51 |
| | Reference Data | _____ | 61 |
| 2 | Capacitor Array GNM Series | _____ | 64 |
| | Specifications and Test Methods | _____ | 70 |
| 3 | Low ESL LLL/LLR/LLA/LLM Series | _____ | 76 |
| | Specifications and Test Methods | _____ | 83 |
| 4 | High-Q Type GJM Series | _____ | 87 |
| | Specifications and Test Methods | _____ | 97 |
| 5 | High Frequency GQM Series | _____ | 100 |
| | Specifications and Test Methods | _____ | 108 |
| | Reference Data | _____ | 111 |
| 6 | Monolithic Microchip GMA Series | _____ | 112 |
| | Specifications and Test Methods | _____ | 115 |
| 7 | For Bonding GMD Series | _____ | 119 |
| | Specifications and Test Methods | _____ | 124 |
| | Package | _____ | 128 |
| | ⚠Caution | _____ | 132 |
| | Notice | _____ | 144 |
| | Reference Data | _____ | 151 |

for EU RoHS Compliant

- All the products in this catalog comply with EU RoHS.
- EU RoHS is "the European Directive 2002/95/EC on the Restriction of the Use of Certain Hazardous Substances in Electrical and Electronic Equipment".
- For more details, please refer to our website 'Murata's Approach for EU RoHS' (<http://www.murata.com/info/rohs.html>).

Chip Monolithic Ceramic Capacitors (Medium Voltage)

| | | |
|----------|---|------------|
| 1 | For General Purpose GRM/GRJ Series | |
| 1-1 | Low Dissipation Factor GRM Series _____ | 160 |
| | Specifications and Test Methods _____ | 164 |
| 1-2 | High Capacitance for General Use GRM Series _____ | 166 |
| | Specifications and Test Methods _____ | 168 |
| 1-3 | Soft Termination Type GRJ Series _____ | 171 |
| | Specifications and Test Methods _____ | 173 |
| 2 | Only for Applications | |
| 2-1 | For LCD Backlight Inverter Circuit GRM/DC3.15kV Series _____ | 176 |
| | Specifications and Test Methods _____ | 177 |
| 2-2 | For Information Devices GR4 Series _____ | 179 |
| | Specifications and Test Methods _____ | 180 |
| 2-3 | For Camera Flash Circuit GR7 Series _____ | 183 |
| | Specifications and Test Methods _____ | 184 |
| 3 | AC250V Type (Which Meet Japanese Law) GA2 Series _____ | 187 |
| | Specifications and Test Methods _____ | 188 |
| 4 | Safety Standard Certified GA3 Series | |
| 4-1 | UL, IEC60384-14 Class X1/Y2 Type GC _____ | 191 |
| 4-2 | IEC60384-14 Class Y2, X1/Y2 Type GF _____ | 192 |
| 4-3 | IEC60384-14 Class Y3 Type GD _____ | 194 |
| 4-4 | IEC60384-14 Class X2 Type GB _____ | 195 |
| | Specifications and Test Methods _____ | 196 |
| | Reference Data (Typical Example) _____ | 200 |
| | Package _____ | 203 |
| | ⚠Caution _____ | 206 |
| | Notice _____ | 214 |
| | ISO 9001 Certifications _____ | 217 |
| | Introduction SimSurfing _____ | 218 |
| | Introduction EMICON-FUN! _____ | 219 |

Please check the MURATA home page (<http://www.murata.com/>) if you cannot find the part number in the catalog.



● Part Numbering

Chip Monolithic Ceramic Capacitors

(Part Number)

| | | | | | | | | | |
|----|---|----|---|----|----|-----|---|-----|---|
| GR | M | 18 | 8 | B1 | 1H | 102 | K | A01 | D |
| ① | ② | ③ | ④ | ⑤ | ⑥ | ⑦ | ⑧ | ⑨ | ⑩ |

① Product ID

② Series

| Product ID | Code | Series |
|------------|------|---|
| GR | J | Soft Termination Type |
| | M | Tin Plated Layer |
| | 4 | Only for Information Devices / Tip & Ring |
| | 7 | Only for Camera Flash Circuit |
| GQ | M | High Frequency for Flow/Reflow Soldering |
| GM | A | Monolithic Microchip |
| | D | For Bonding |
| GN | M | Capacitor Array |
| LL | L | Low ESL Type |
| | R | Controlled ESR Low ESL Type |
| | A | 8-termination Low ESL Type |
| | M | 10-termination Low ESL Type |
| GJ | M | High Frequency Low Loss Type |
| GA | 2 | For AC250V (r.m.s.) |
| | 3 | Safety Standard Certified Type |

③ Dimensions (L×W)

| Code | Dimensions (L×W) | EIA |
|------|------------------|--------|
| 02 | 0.4×0.2mm | 01005 |
| 03 | 0.6×0.3mm | 0201 |
| 05 | 0.5×0.5mm | 0202 |
| 08 | 0.8×0.8mm | 0303 |
| 0D | 0.38×0.38mm | 015015 |
| 0M | 0.9×0.6mm | 0302 |
| 15 | 1.0×0.5mm | 0402 |
| 18 | 1.6×0.8mm | 0603 |
| 1M | 1.37×1.0mm | 0504 |
| 21 | 2.0×1.25mm | 0805 |
| 22 | 2.8×2.8mm | 1111 |
| 31 | 3.2×1.6mm | 1206 |
| 32 | 3.2×2.5mm | 1210 |
| 42 | 4.5×2.0mm | 1808 |
| 43 | 4.5×3.2mm | 1812 |
| 52 | 5.7×2.8mm | 2211 |
| 55 | 5.7×5.0mm | 2220 |

④ Dimension (T) (Except GNM)

| Code | Dimension (T) |
|------|----------------------------------|
| 2 | 0.2mm |
| 3 | 0.3mm |
| 5 | 0.5mm |
| 6 | 0.6mm |
| 7 | 0.7mm |
| 8 | 0.8mm |
| 9 | 0.85mm |
| A | 1.0mm |
| B | 1.25mm |
| C | 1.6mm |
| D | 2.0mm |
| E | 2.5mm |
| F | 3.2mm |
| M | 1.15mm |
| N | 1.35mm |
| Q | 1.5mm |
| R | 1.8mm |
| S | 2.8mm |
| X | Depends on individual standards. |

④ Elements (GNM Only)

| Code | Elements |
|------|------------|
| 2 | 2-elements |
| 4 | 4-elements |

Continued on the following page. 

Continued from the preceding page.

5 Temperature Characteristics

| Temperature Characteristic Codes | | | Temperature Characteristics | | | Operating Temperature Range |
|----------------------------------|-----------------|-----|-----------------------------|-------------------|---|-----------------------------|
| Code | Public STD Code | | Reference Temperature | Temperature Range | Capacitance Change or Temperature Coefficient | |
| 1X | SL *1 | JIS | 20°C | 20 to 85°C | +350 to -1000ppm/°C | -55 to 125°C |
| 2C | CH *1 | JIS | 20°C | 20 to 125°C | 0±60ppm/°C | -55 to 125°C |
| 2P | PH *1 | JIS | 20°C | 20 to 85°C | -150±60ppm/°C | -25 to 85°C |
| 2R | RH *1 | JIS | 20°C | 20 to 85°C | -220±60ppm/°C | -25 to 85°C |
| 2S | SH *1 | JIS | 20°C | 20 to 85°C | -330±60ppm/°C | -25 to 85°C |
| 2T | TH *1 | JIS | 20°C | 20 to 85°C | -470±60ppm/°C | -25 to 85°C |
| 3C | CJ *1 | JIS | 20°C | 20 to 125°C | 0±120ppm/°C | -55 to 125°C |
| 3P | PJ *1 | JIS | 20°C | 20 to 85°C | -150±120ppm/°C | -25 to 85°C |
| 3R | RJ *1 | JIS | 20°C | 20 to 85°C | -220±120ppm/°C | -25 to 85°C |
| 3S | SJ *1 | JIS | 20°C | 20 to 85°C | -330±120ppm/°C | -25 to 85°C |
| 3T | TJ *1 | JIS | 20°C | 20 to 85°C | -470±120ppm/°C | -25 to 85°C |
| 3U | UJ *1 | JIS | 20°C | 20 to 85°C | -750±120ppm/°C | -25 to 85°C |
| 4C | CK *1 | JIS | 20°C | 20 to 125°C | 0±250ppm/°C | -55 to 125°C |
| 5C | COG *1 | EIA | 25°C | 25 to 125°C | 0±30ppm/°C | -55 to 125°C |
| 5G | X8G *1 | EIA | 25°C | 25 to 150°C | 0±30ppm/°C | -55 to 150°C |
| 6C | COH *1 | EIA | 25°C | 25 to 125°C | 0±60ppm/°C | -55 to 125°C |
| 6P | P2H *1 | EIA | 25°C | 25 to 85°C | -150±60ppm/°C | -55 to 125°C |
| 6R | R2H *1 | EIA | 25°C | 25 to 85°C | -220±60ppm/°C | -55 to 125°C |
| 6S | S2H *1 | EIA | 25°C | 25 to 85°C | -330±60ppm/°C | -55 to 125°C |
| 6T | T2H *1 | EIA | 25°C | 25 to 85°C | -470±60ppm/°C | -55 to 125°C |
| 7U | U2J *1 | EIA | 25°C | 25 to 125°C *6 | -750±120ppm/°C | -55 to 125°C |
| B1 | B *2 | JIS | 20°C | -25 to 85°C | ±10% | -25 to 85°C |
| B3 | B | JIS | 20°C | -25 to 85°C | ±10% | -25 to 85°C |
| C7 | X7S | EIA | 25°C | -55 to 125°C | ±22% | -55 to 125°C |
| C8 | X6S | EIA | 25°C | -55 to 105°C | ±22% | -55 to 105°C |
| D7 | X7T | EIA | 25°C | -55 to 125°C | +22, -33% | -55 to 125°C |
| D8 | X6T | EIA | 25°C | -55 to 105°C | +22, -33% | -55 to 105°C |
| E7 | X7U | EIA | 25°C | -55 to 125°C | +22, -56% | -55 to 125°C |
| F1 | F *2 | JIS | 20°C | -25 to 85°C | +30, -80% | -25 to 85°C |
| F5 | Y5V | EIA | 25°C | -30 to 85°C | +22, -82% | -30 to 85°C |
| L8 | X8L | *3 | 25°C | -55 to 150°C | +15, -40% | -55 to 150°C |
| R1 | R *2 | JIS | 20°C | -55 to 125°C | ±15% | -55 to 125°C |
| R3 | R | JIS | 20°C | -55 to 125°C | ±15% | -55 to 125°C |
| R6 | X5R | EIA | 25°C | -55 to 85°C | ±15% | -55 to 85°C |
| R7 | X7R | EIA | 25°C | -55 to 125°C | ±15% | -55 to 125°C |
| R9 | X8R | EIA | 25°C | -55 to 150°C | ±15% | -55 to 150°C |
| W0 | - | - | 25°C | -55 to 125°C | ±10% *4 | -55 to 125°C |
| | | | | | +22, -33% *5 | |

*1 Please refer to table for Capacitance Change under reference temperature.

*2 Capacitance change is specified with 50% rated voltage applied.

*3 Murata Temperature Characteristic Code.

*4 Apply DC350V bias.

*5 No DC bias.

*6 Rated Voltage 100Vdc max : 25 to 85°C

Continued on the following page. 

Continued from the preceding page.

●Capacitance Change from each temperature

JIS Code

| Murata Code | Capacitance Change from 20°C (%) | | | | | |
|-------------|----------------------------------|-------|-------|-------|-------|-------|
| | -55°C | | -25°C | | -10°C | |
| | Max. | Min. | Max. | Min. | Max. | Min. |
| 1X | - | - | - | - | - | - |
| 2C | 0.82 | -0.45 | 0.49 | -0.27 | 0.33 | -0.18 |
| 2P | - | - | 1.32 | 0.41 | 0.88 | 0.27 |
| 2R | - | - | 1.70 | 0.72 | 1.13 | 0.48 |
| 2S | - | - | 2.30 | 1.22 | 1.54 | 0.81 |
| 2T | - | - | 3.07 | 1.85 | 2.05 | 1.23 |
| 3C | 1.37 | -0.90 | 0.82 | -0.54 | 0.55 | -0.36 |
| 3P | - | - | 1.65 | 0.14 | 1.10 | 0.09 |
| 3R | - | - | 2.03 | 0.45 | 1.35 | 0.30 |
| 3S | - | - | 2.63 | 0.95 | 1.76 | 0.63 |
| 3T | - | - | 3.40 | 1.58 | 2.27 | 1.05 |
| 3U | - | - | 4.94 | 2.84 | 3.29 | 1.89 |
| 4C | 2.56 | -1.88 | 1.54 | -1.13 | 1.02 | -0.75 |

EIA Code

| Murata Code | Capacitance Change from 25°C (%) | | | | | |
|-------------|----------------------------------|-------|-------|-------|-------|-------|
| | -55°C | | -30°C | | -10°C | |
| | Max. | Min. | Max. | Min. | Max. | Min. |
| 5C/5G | 0.58 | -0.24 | 0.40 | -0.17 | 0.25 | -0.11 |
| 6C | 0.87 | -0.48 | 0.59 | -0.33 | 0.38 | -0.21 |
| 6P | 2.33 | 0.72 | 1.61 | 0.50 | 1.02 | 0.32 |
| 6R | 3.02 | 1.28 | 2.08 | 0.88 | 1.32 | 0.56 |
| 6S | 4.09 | 2.16 | 2.81 | 1.49 | 1.79 | 0.95 |
| 6T | 5.46 | 3.28 | 3.75 | 2.26 | 2.39 | 1.44 |
| 7U | 8.78 | 5.04 | 6.04 | 3.47 | 3.84 | 2.21 |

⑥ Rated Voltage

| Code | Rated Voltage |
|------|---|
| 0E | DC2.5V |
| 0G | DC4V |
| 0J | DC6.3V |
| 1A | DC10V |
| 1C | DC16V |
| 1E | DC25V |
| YA | DC35V |
| 1H | DC50V |
| 2A | DC100V |
| 2D | DC200V |
| 2E | DC250V |
| YD | DC300V |
| 2H | DC500V |
| 2J | DC630V |
| 3A | DC1kV |
| 3D | DC2kV |
| 3F | DC3.15kV |
| BB | DC350V (for Camera Flash Circuit) |
| E2 | AC250V |
| GC | X1/Y2; AC250V (Safety Standard Certified Type GC) |
| GF | Y2, X1/Y2; AC250V (Safety Standard Certified Type GF) |
| GD | Y3; AC250V (Safety Standard Certified Type GD) |
| GB | X2; AC250V (Safety Standard Certified Type GB) |

⑦ Capacitance

Expressed by three-digit alphanumerics. The unit is picofarad (pF). The first and second figures are significant digits, and the third figure expresses the number of zeros which follow the two numbers. If there is a decimal point, it is expressed by the capital letter "R." In this case, all figures are significant digits.

| Ex.) Code | Capacitance |
|-----------|-------------|
| R50 | 0.5pF |
| 1R0 | 1.0pF |
| 100 | 10pF |
| 103 | 10000pF |

Continued on the following page. 

Please check the MURATA home page (<http://www.murata.com/>) if you cannot find the part number in the catalog.

Continued from the preceding page.

⑧ Capacitance Tolerance

| Code | Capacitance Tolerance | TC | Series | Capacitance Step | |
|----------|-----------------------|----------------------------------|------------------------|------------------|-------------------------|
| W | ±0.05pF | CΔ | GRM/GJM | ≤9.9pF | 0.1pF |
| B | ±0.1pF | CΔ | GRM/GJM | ≤9.9pF | 0.1pF |
| | | | GQM | ≤1pF | 0.1pF |
| C | ±0.25pF | CΔ | GRM/GJM | ≤9.9pF | 0.1pF |
| | | except CΔ | GRM | ≤5pF | * 1pF |
| | | CΔ | GQM | ≤1pF | 0.1pF |
| D | ±0.5pF | CΔ | GRM/GJM | 5.1 to 9.9pF | 0.1pF |
| | | except CΔ | GRM | 5.1 to 9.9pF | * 1pF |
| | | CΔ | GQM | 5.1 to 9.9pF | 1pF Step and E24 Series |
| G | ±2% | CΔ | GJM | ≥10pF | E12 Series |
| | | CΔ | GQM | ≥10pF | E24 Series |
| J | ±5% | CΔ, SL, U2J | GRM/GA3 | ≥10pF | E12 Series |
| | | CΔ | GQM/GJM | ≥10pF | E24 Series |
| K | ±10% | B, R, X7R, X5R, ZLM | GRJ/GRM/GR7/GA3 | E6 Series | |
| | | C0G | GNM | E6 Series | |
| | | B, R, X7R, X5R, ZLM | GR4, GMD | E12 Series | |
| M | ±20% | B, R, X7R, X7S | GRM/GMA | E6 Series | |
| | | X5R, X7R, X7S | GNM | E3 Series | |
| | | X7R | GA2 | E3 Series | |
| | | X5R, X7R, X7S, X6S | LLL/LLR/LLA/LLM | E3 Series | |
| Z | +80%, -20% | F, Y5V | GRM | E3 Series | |
| R | | Depends on individual standards. | | | |

* E24 series is also available.

⑨ Individual Specification Code (Except LLR)

Expressed by three figures.

⑨ ESR (LLR Only)

| Code | ESR |
|------------|--------|
| E01 | 100mΩ |
| E03 | 220mΩ |
| E05 | 470mΩ |
| E07 | 1000mΩ |

⑩ Packaging

| Code | Packaging |
|----------|-----------------------------|
| L | ø180mm Embossed Taping |
| D | ø180mm Paper Taping |
| E | ø180mm Paper Taping (LLL15) |
| K | ø330mm Embossed Taping |
| J | ø330mm Paper Taping |
| F | ø330mm Paper Taping (LLL15) |
| B | Bulk |
| C | Bulk Case |
| T | Bulk Tray |

Please check the MURATA home page (<http://www.murata.com/>) if you cannot find the part number in the catalog.

Selection Guide For Chip Monolithic Ceramic Capacitors

| | Function | Type | Series |
|--|--|---|--|
| Applications? | Decoupling, Smoothing | High Capacitance | GRM (X5R, X7R, Y5V etc.) 68pF-100μF |
| | | Array (2 or 4 Elements) | GNM 10pF-2.2μF |
| | Frequency Control/Tuning, Impedance Matching | Class 1 TC's | GRM (C0G) 0.1pF-0.1μF |
| | | | GRM (U2J etc.) |
| | High Speed Decoupling | Low Inductance (Reverse Geometry) | LLL 2200pF-10μF |
| | | Low Inductance (Controlled ESR) | LLR 1.0μF |
| | | Low Inductance (Multi-Termination) | LLA/LLM (From 1GHz) 0.01μF-4.7μF |
| | High Frequency | Low ESR, Ultra Small | GJM (500MHz to 10GHz) 0.1pF-33pF |
| | | Lowest ESR | GQM (500MHz to 10GHz) 0.1pF-100pF |
| | Optical Communications | Wire-Die-Bonding | GMA 100pF-0.47μF GMD 100pF-1μF |
| | Medium Voltage High Frequency Snubber | 250V/630V/1kV/2kV/3.15kV Low Dissipation | GRM (C0G, U2J) 10pF-10000pF |
| | Medium Voltage LCD Backlight Inverter | 3.15kV Low Dissipation | GRM (C0G) 5pF-47pF |
| | Medium Voltage Decoupling, Smoothing | 250V/630V/1kV High Capacitance | GRM (X7R) 220pF-1μF |
| | | 250V/630V/1kV Soft Termination Type | GRJ (X7R) 470pF-1μF |
| | Medium Voltage Only for Camera Flash Circuit | 350V High Capacitance | GR7 10000pF-47000pF |
| | Medium Voltage Only for Information Devices | 2kV High Capacitance | GR4 100pF-10000pF |
| | | Safety Standard Certified | Type GD 10pF-4700pF Type GF 10pF-4700pF |
| | AC Lines Noise Removal | Safety Standard Certified | Type GC 100pF-330pF Type GF 470pF-4700pF Type GB 10000pF-56000pF |
| AC250V which meets Japanese Law | | GA2 470pF-0.1μF | |
| Automotive (Powertrain, Safety Equipment) | High Capacitance | GCM (X7R etc.) 100pF-47μF | |
| | Class 1 TC's | GCM (C0G etc.) 1.0pF-56000pF | |
| Medium Voltage for Automotive (Powertrain, Safety Equipment) | 250V/630V Low Dissipation | GCM (U2J) 10pF-10000pF | |
| | 250V/630V Soft Termination Type | GCJ (X7R) 1000pF-0.47μF | |

Chip Monolithic Ceramic Capacitors

| | | |
|----------|--|------------|
| 1 | For General Purpose GRM Series _____ | 8 |
| | Specifications and Test Methods _____ | 51 |
| | Reference Data _____ | 61 |
| <hr/> | | |
| 2 | Capacitor Array GNM Series _____ | 64 |
| | Specifications and Test Methods _____ | 70 |
| <hr/> | | |
| 3 | Low ESL LLL/LLR/LLA/LLM Series _____ | 76 |
| | Specifications and Test Methods _____ | 83 |
| <hr/> | | |
| 4 | High-Q Type GJM Series _____ | 87 |
| | Specifications and Test Methods _____ | 97 |
| <hr/> | | |
| 5 | High Frequency GQM Series _____ | 100 |
| | Specifications and Test Methods _____ | 108 |
| | Reference Data _____ | 111 |
| <hr/> | | |
| 6 | Monolithic Microchip GMA Series _____ | 112 |
| | Specifications and Test Methods _____ | 115 |
| <hr/> | | |
| 7 | For Bonding GMD Series _____ | 119 |
| | Specifications and Test Methods _____ | 124 |
| <hr/> | | |
| | Package _____ | 128 |
| | △Caution _____ | 132 |
| | Notice _____ | 144 |
| | Reference Data _____ | 151 |
| <hr/> | | |

For General
GRM Series

Array
GNM Series

Low ESL
LLL Series

High-Q
GJM Series

High Frequency
GQM Series

Monolithic Microchip
GMA Series

For Bonding
GMD Series

Product Information

Chip Monolithic Ceramic Capacitors



For General Purpose GRM Series

For General
GRM Series

Array
GMM Series

Low ESL
LL□ Series

High-Q
GJM Series

High Frequency
GOM Series

Monolithic Microchip
GMA Series

For Bonding
GMD Series

Product Information

■ Features

1. Higher resistance of solder-leaching due to the Ni-barriered termination, applicable for reflow-soldering, and flow-soldering (GRM18/21/31 type only).
2. The GRM series is a lead free product.
3. Smaller size and higher capacitance value.
4. High reliability and no polarity.
5. Excellent pulse response and noise reduction due to the low impedance at high frequency.
6. The GRM series is available in paper or embossed tape and reel packaging for automatic placement. Bulk case packaging is also available for GRM15/18/21(T=0.6,1.25).
7. TA replacement.

■ Applications

General electronic equipment

| Part Number | Dimensions (mm) | | | | |
|-------------|-----------------|-----------|------------------|--------------|--------|
| | L | W | T | e | g min. |
| GRM022 | 0.4 ±0.02 | 0.2 ±0.02 | 0.2 ±0.02 | 0.07 to 0.14 | 0.13 |
| GRM033 | 0.6 ±0.03 | 0.3 ±0.03 | 0.3 ±0.03 | 0.1 to 0.2 | 0.2 |
| GRM15X | 1.0 ±0.05 | 0.5 ±0.05 | 0.25 ±0.05 | 0.1 to 0.3 | 0.4 |
| GRM153 | | | 0.3 ±0.03 | | |
| GRM155 | 1.6 ±0.1 | 0.8 ±0.1 | 0.5 ±0.05 | 0.15 to 0.35 | 0.3 |
| GRM185 | | | 0.8 ±0.1 | | |
| GRM188* | 2.0 ±0.1 | 1.25 ±0.1 | 0.6 ±0.1 | 0.2 to 0.7 | 0.7 |
| GRM216 | | | 0.85 ±0.1 | | |
| GRM219 | 3.2 ±0.15 | 1.6 ±0.15 | 1.0 ±0/-0.2 | 0.3 to 0.8 | 1.5 |
| GRM21A | | | 1.25 ±0.1 | | |
| GRM21B | 3.2 ±0.2 | 1.6 ±0.2 | 0.6 ±0.1 | 0.3 min. | 1.0 |
| GRM316 | | | 0.85 ±0.1 | | |
| GRM319 | 3.2 ±0.3 | 2.5 ±0.2 | 1.15 ±0.1 | 0.3 min. | 1.0 |
| GRM31M | | | 1.6 ±0.2 | | |
| GRM31C | 3.2 ±0.3 | 2.5 ±0.2 | 0.85 ±0.15/-0.05 | 0.3 min. | 1.0 |
| GRM329 | | | 1.0 ±0/-0.2 | | |
| GRM32A | 3.2 ±0.3 | 2.5 ±0.2 | 1.15 ±0.1 | 0.3 min. | 1.0 |
| GRM32M | | | 1.35 ±0.15 | | |
| GRM32N | 3.2 ±0.3 | 2.5 ±0.2 | 1.6 ±0.2 | 0.3 min. | 1.0 |
| GRM32C | | | 1.8 ±0.2 | | |
| GRM32R | 3.2 ±0.3 | 2.5 ±0.2 | 2.0 ±0.2 | 0.3 min. | 1.0 |
| GRM32D | | | 2.5 ±0.2 | | |
| GRM32E | 3.2 ±0.3 | 2.5 ±0.2 | 2.5 ±0.2 | 0.3 min. | 1.0 |
| GRM32Z | | | 2.5 ±0.2 | | |

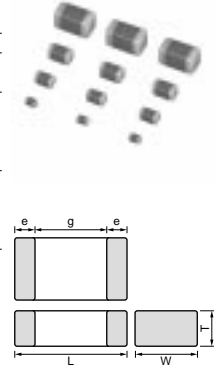

* Bulk Case: 1.6 ±0.07(L) × 0.8 ±0.07(W) × 0.8 ±0.07(T)
The figures indicate typical specification.

Capacitance Table

Temperature Compensating Type C0G(5C),U2J(7U) Characteristics

| 6 | | ex.6: T Dimension [mm] | | | | | | | | | | | | | | | | | | | |
|---------------------|----------|------------------------|---------|----------|---------------------|---------|---------------------|---------|---------------------|---------|----------------------|---------|---------------------|---------|---------------------|---------|---------------------|---------|---------------------|----------------------|---------|
| TC | LxW [mm] | C0G(5C) | | | | | | | | | | U2J(7U) | | | | | | | | | |
| | | 0.4x0.2 (02) <01005> | | | 0.6x0.3 (03) <0201> | | 1.0x0.5 (15) <0402> | | 1.6x0.8 (18) <0603> | | 2.0x1.25 (21) <0805> | | 3.2x1.6 (31) <1206> | | 0.6x0.3 (03) <0201> | | 1.0x0.5 (15) <0402> | | 1.6x0.8 (18) <0603> | 2.0x1.25 (21) <0805> | |
| Rated Voltage [Vdc] | | 16 (1C) | 10 (1A) | 6.3 (0J) | 50 (1H) | 50 (1H) | 100 (1E) | 50 (1H) | 100 (1E) | 50 (1H) | 100 (1E) | 50 (1H) | 50 (1H) | 25 (1E) | 50 (1H) | 10 (1A) | 50 (1H) | 10 (1A) | 50 (1H) | 10 (1A) | 50 (1H) |
| Capacitance | | | | | | | | | | | | | | | | | | | | | |
| 0.1pF(R10) | | | | | 3 | 3, 5 | | | | | | | | | | | | | | | |
| 0.2pF(R20) | 2 | | | | 3 | 3, 5 | | | | | | | | | | | | | | | |
| 0.3pF(R30) | 2 | | | | 3 | 3, 5 | | | | | | | | | | | | | | | |
| 0.4pF(R40) | 2 | | | | 3 | 3, 5 | | | | | | | | | | | | | | | |
| 0.5pF(R50) | 2 | | | | 3 | 3, 5 | | | | | | | | | | | | | | | |
| 0.6pF(R60) | 2 | | | | 3 | 3, 5 | | | | | | | | | | | | | | | |
| 0.7pF(R70) | 2 | | | | 3 | 3, 5 | | | | | | | | | | | | | | | |
| 0.8pF(R80) | 2 | | | | 3 | 3, 5 | | | | | | | | | | | | | | | |
| 0.9pF(R90) | 2 | | | | 3 | 3, 5 | | | | | | | | | | | | | | | |
| 1.0pF(1R0) | 2 | | | | 3 | 3, 5 | | | | | | | | 3 | | 5 | | | | | |
| 1.1pF(1R1) | 2 | | | | 3 | 3, 5 | | | | | | | | | | | | | | | |
| 1.2pF(1R2) | 2 | | | | 3 | 3, 5 | | | | | | | | | | | | | | | |
| 1.3pF(1R3) | 2 | | | | 3 | 3, 5 | | | | | | | | | | | | | | | |
| 1.4pF(1R4) | 2 | | | | 3 | 3, 5 | | | | | | | | | | | | | | | |
| 1.5pF(1R5) | 2 | | | | 3 | 3, 5 | | | | | | | | | | | | | | | |
| 1.6pF(1R6) | 2 | | | | 3 | 3, 5 | | | | | | | | | | | | | | | |
| 1.7pF(1R7) | 2 | | | | 3 | 3, 5 | | | | | | | | | | | | | | | |
| 1.8pF(1R8) | 2 | | | | 3 | 3, 5 | | | | | | | | | | | | | | | |
| 1.9pF(1R9) | 2 | | | | 3 | 3, 5 | | | | | | | | | | | | | | | |
| 2.0pF(2R0) | 2 | | | | 3 | 3, 5 | | | | | | | | 3 | | 5 | | | | | |
| 2.1pF(2R1) | 2 | | | | 3 | 3, 5 | | | | | | | | | | | | | | | |
| 2.2pF(2R2) | 2 | | | | 3 | 3, 5 | | | | | | | | | | | | | | | |
| 2.3pF(2R3) | 2 | | | | 3 | 3, 5 | | | | | | | | | | | | | | | |
| 2.4pF(2R4) | 2 | | | | 3 | 3, 5 | | | | | | | | | | | | | | | |
| 2.5pF(2R5) | 2 | | | | 3 | 3, 5 | | | | | | | | | | | | | | | |
| 2.6pF(2R6) | 2 | | | | 3 | 3, 5 | | | | | | | | | | | | | | | |
| 2.7pF(2R7) | 2 | | | | 3 | 3, 5 | | | | | | | | | | | | | | | |
| 2.8pF(2R8) | 2 | | | | 3 | 3, 5 | | | | | | | | | | | | | | | |
| 2.9pF(2R9) | 2 | | | | 3 | 3, 5 | | | | | | | | | | | | | | | |
| 3.0pF(3R0) | 2 | | | | 3 | 3, 5 | | | | | | | | 3 | | 5 | | | | | |
| 3.1pF(3R1) | 2 | | | | 3 | 3, 5 | | | | | | | | | | | | | | | |
| 3.2pF(3R2) | 2 | | | | 3 | 3, 5 | | | | | | | | | | | | | | | |
| 3.3pF(3R3) | 2 | | | | 3 | 3, 5 | | | | | | | | | | | | | | | |
| 3.4pF(3R4) | 2 | | | | 3 | 3, 5 | | | | | | | | | | | | | | | |
| 3.5pF(3R5) | 2 | | | | 3 | 3, 5 | | | | | | | | | | | | | | | |
| 3.6pF(3R6) | 2 | | | | 3 | 3, 5 | | | | | | | | | | | | | | | |
| 3.7pF(3R7) | 2 | | | | 3 | 3, 5 | | | | | | | | | | | | | | | |
| 3.8pF(3R8) | 2 | | | | 3 | 3, 5 | | | | | | | | | | | | | | | |
| 3.9pF(3R9) | 2 | | | | 3 | 3, 5 | | | | | | | | | | | | | | | |
| 4.0pF(4R0) | 2 | | | | 3 | 3, 5 | | | | | | | | 3 | | 5 | | | | | |
| 4.1pF(4R1) | 2 | | | | 3 | 3, 5 | | | | | | | | | | | | | | | |
| 4.2pF(4R2) | 2 | | | | 3 | 3, 5 | | | | | | | | | | | | | | | |
| 4.3pF(4R3) | 2 | | | | 3 | 3, 5 | | | | | | | | | | | | | | | |
| 4.4pF(4R4) | 2 | | | | 3 | 3, 5 | | | | | | | | | | | | | | | |
| 4.5pF(4R5) | 2 | | | | 3 | 3, 5 | | | | | | | | | | | | | | | |
| 4.6pF(4R6) | 2 | | | | 3 | 3, 5 | | | | | | | | | | | | | | | |
| 4.7pF(4R7) | 2 | | | | 3 | 3, 5 | | | | | | | | | | | | | | | |
| 4.8pF(4R8) | 2 | | | | 3 | 3, 5 | | | | | | | | | | | | | | | |
| 4.9pF(4R9) | 2 | | | | 3 | 3, 5 | | | | | | | | | | | | | | | |

The part number code is shown in () and Unit is shown in []. < >: EIA [inch] Code

Continued on the following page.

Capacitance Table

Continued from the preceding page.

6 ex.6: T Dimension [mm]

| TC | C0G(5C) | | | | | | | | | | U2J(7U) | | | | | | | | | | |
|---------------------|----------|---------|----------------------|---------|---------------------------------|----------|---------------------|----------|----------------------|----------|---------------------|---------|---------------------|---------|---------------------|---------|---------------------|---------|----------------------|---------|---------------------|
| | LxW [mm] | | 0.4x0.2 (02) <01005> | | 0.6x0.3 (03) (15) <0201> <0402> | | 1.6x0.8 (18) <0603> | | 2.0x1.25 (21) <0805> | | 3.2x1.6 (31) <1206> | | 0.6x0.3 (03) <0201> | | 1.0x0.5 (15) <0402> | | 1.6x0.8 (18) <0603> | | 2.0x1.25 (21) <0805> | | 3.2x1.6 (31) <1206> |
| Rated Voltage [Vdc] | 16 (1C) | 10 (1A) | 6.3 (0J) | 50 (1H) | 50 (1H) | 100 (1E) | 50 (1H) | 100 (1E) | 50 (1H) | 100 (1E) | 50 (1H) | 50 (1H) | 25 (1E) | 50 (1H) | 10 (1A) | 50 (1H) | 10 (1A) | 50 (1H) | 10 (1A) | 50 (1H) | |
| Capacitance | | | | | | | | | | | | | | | | | | | | | |
| 5.0pF(5R0) | 2 | | | 3 | 3, 5 | | | | | | | 3 | | 5 | | | | | | | |
| 5.1pF(5R1) | 2 | | | 3 | 3, 5 | | | | | | | | | | | | | | | | |
| 5.2pF(5R2) | 2 | | | 3 | 3, 5 | | | | | | | | | | | | | | | | |
| 5.3pF(5R3) | 2 | | | 3 | 3, 5 | | | | | | | | | | | | | | | | |
| 5.4pF(5R4) | 2 | | | 3 | 3, 5 | | | | | | | | | | | | | | | | |
| 5.5pF(5R5) | 2 | | | 3 | 3, 5 | | | | | | | | | | | | | | | | |
| 5.6pF(5R6) | 2 | | | 3 | 3, 5 | | | | | | | | | | | | | | | | |
| 5.7pF(5R7) | 2 | | | 3 | 3, 5 | | | | | | | | | | | | | | | | |
| 5.8pF(5R8) | 2 | | | 3 | 3, 5 | | | | | | | | | | | | | | | | |
| 5.9pF(5R9) | 2 | | | 3 | 3, 5 | | | | | | | | | | | | | | | | |
| 6.0pF(6R0) | 2 | | | 3 | 3, 5 | | | | | | | 3 | | 5 | | | | | | | |
| 6.1pF(6R1) | 2 | | | 3 | 3, 5 | | | | | | | | | | | | | | | | |
| 6.2pF(6R2) | 2 | | | 3 | 3, 5 | | | | | | | | | | | | | | | | |
| 6.3pF(6R3) | 2 | | | 3 | 3, 5 | | | | | | | | | | | | | | | | |
| 6.4pF(6R4) | 2 | | | 3 | 3, 5 | | | | | | | | | | | | | | | | |
| 6.5pF(6R5) | 2 | | | 3 | 3, 5 | | | | | | | | | | | | | | | | |
| 6.6pF(6R6) | 2 | | | 3 | 3, 5 | | | | | | | | | | | | | | | | |
| 6.7pF(6R7) | 2 | | | 3 | 3, 5 | | | | | | | | | | | | | | | | |
| 6.8pF(6R8) | 2 | | | 3 | 3, 5 | | | | | | | | | | | | | | | | |
| 6.9pF(6R9) | 2 | | | 3 | 3, 5 | | | | | | | | | | | | | | | | |
| 7.0pF(7R0) | 2 | | | 3 | 3, 5 | | | | | | | 3 | | 5 | | | | | | | |
| 7.1pF(7R1) | 2 | | | 3 | 3, 5 | | | | | | | | | | | | | | | | |
| 7.2pF(7R2) | 2 | | | 3 | 3, 5 | | | | | | | | | | | | | | | | |
| 7.3pF(7R3) | 2 | | | 3 | 3, 5 | | | | | | | | | | | | | | | | |
| 7.4pF(7R4) | 2 | | | 3 | 3, 5 | | | | | | | | | | | | | | | | |
| 7.5pF(7R5) | 2 | | | 3 | 3, 5 | | | | | | | | | | | | | | | | |
| 7.6pF(7R6) | 2 | | | 3 | 3, 5 | | | | | | | | | | | | | | | | |
| 7.7pF(7R7) | 2 | | | 3 | 3, 5 | | | | | | | | | | | | | | | | |
| 7.8pF(7R8) | 2 | | | 3 | 3, 5 | | | | | | | | | | | | | | | | |
| 7.9pF(7R9) | 2 | | | 3 | 3, 5 | | | | | | | | | | | | | | | | |
| 8.0pF(8R0) | 2 | | | 3 | 3, 5 | | | | | | | 3 | | 5 | | | | | | | |
| 8.1pF(8R1) | 2 | | | 3 | 3, 5 | | | | | | | | | | | | | | | | |
| 8.2pF(8R2) | 2 | | | 3 | 3, 5 | | | | | | | | | | | | | | | | |
| 8.3pF(8R3) | 2 | | | 3 | 3, 5 | | | | | | | | | | | | | | | | |
| 8.4pF(8R4) | 2 | | | 3 | 3, 5 | | | | | | | | | | | | | | | | |
| 8.5pF(8R5) | 2 | | | 3 | 3, 5 | | | | | | | | | | | | | | | | |
| 8.6pF(8R6) | 2 | | | 3 | 3, 5 | | | | | | | | | | | | | | | | |
| 8.7pF(8R7) | 2 | | | 3 | 3, 5 | | | | | | | | | | | | | | | | |
| 8.8pF(8R8) | 2 | | | 3 | 3, 5 | | | | | | | | | | | | | | | | |
| 8.9pF(8R9) | 2 | | | 3 | 3, 5 | | | | | | | | | | | | | | | | |
| 9.0pF(9R0) | 2 | | | 3 | 3, 5 | | | | | | | 3 | | 5 | | | | | | | |
| 9.1pF(9R1) | 2 | | | 3 | 3, 5 | | | | | | | | | | | | | | | | |
| 9.2pF(9R2) | 2 | | | 3 | 3, 5 | | | | | | | | | | | | | | | | |
| 9.3pF(9R3) | 2 | | | 3 | 3, 5 | | | | | | | | | | | | | | | | |
| 9.4pF(9R4) | 2 | | | 3 | 3, 5 | | | | | | | | | | | | | | | | |
| 9.5pF(9R5) | 2 | | | 3 | 3, 5 | | | | | | | | | | | | | | | | |
| 9.6pF(9R6) | 2 | | | 3 | 3, 5 | | | | | | | | | | | | | | | | |
| 9.7pF(9R7) | 2 | | | 3 | 3, 5 | | | | | | | | | | | | | | | | |
| 9.8pF(9R8) | 2 | | | 3 | 3, 5 | | | | | | | | | | | | | | | | |
| 9.9pF(9R9) | 2 | | | 3 | 3, 5 | | | | | | | | | | | | | | | | |

The part number code is shown in () and Unit is shown in []. < >: EIA [inch] Code

Continued on the following page.

Capacitance Table

Continued from the preceding page.

6 ex.6: T Dimension [mm]

| TC | LxW [mm] | C0G(5C) | | | | | | | | | | U2J(7U) | | | | | | | | | | | | |
|--------------|-------------|----------------------------|------------|-------------|---------------------------|------------|---------------------------|------------|---------------------------|------------|----------------------------|------------|---------------------------|------------|---------------------------|------------|---------------------------|------------|---------------------------|------------|----------------------------|------------|---------------------------|--|
| | | 0.4x0.2 (02) <01005> | | | 0.6x0.3 (03) <0201> | | 1.0x0.5 (15) <0402> | | 1.6x0.8 (18) <0603> | | 2.0x1.25 (21) <0805> | | 3.2x1.6 (31) <1206> | | 0.6x0.3 (03) <0201> | | 1.0x0.5 (15) <0402> | | 1.6x0.8 (18) <0603> | | 2.0x1.25 (21) <0805> | | 3.2x1.6 (31) <1206> | |
| | | 16 (1C) | 10 (1A) | 6.3 (0J) | 50 (1H) | 50 (1H) | 100 (1E) | 50 (1H) | 100 (1E) | 50 (1H) | 100 (1E) | 50 (1H) | 50 (1H) | 25 (1E) | 50 (1H) | 10 (1A) | 50 (1H) | 10 (1A) | 50 (1H) | 10 (1A) | 50 (1H) | 10 (1A) | 50 (1H) | |
| 10pF(100) | 2 | | | | 3 | 3,5 | 8 | 8 | | | | | | 3 | | 5 | | | | | | | | |
| 12pF(120) | 2 | | | | 3 | 3,5 | 8 | 8 | | | | | | 3 | | 5 | | | | | | | | |
| 15pF(150) | 2 | | | | 3 | 3,5 | 8 | 8 | | | | | | 3 | | 5 | | | | | | | | |
| 18pF(180) | 2 | | | | 3 | 3,5 | 8 | 8 | | | | | | | 3 | 5 | | | | | | | | |
| 22pF(220) | 2 | | | | 3 | 3,5 | 8 | 8 | | | | | | | 3 | 5 | | | | | | | | |
| 27pF(270) | 2 | | | | 3 | 3,5 | 8 | 8 | | | | | | | 3 | 5 | | | | | | | | |
| 33pF(330) | 2 | | | | 3 | 3,5 | 8 | 8 | | | | | | | 3 | 5 | | | | | | | | |
| 39pF(390) | 2 | | | | 3 | 3,5 | 8 | 8 | | | | | | | 3 | 5 | | | | | | | | |
| 47pF(470) | 2 | | | | 3 | 3,5 | 8 | 8 | | | | | | | 3 | 5 | | | | | | | | |
| 56pF(560) | | 2 | 2 | | 3 | 3,5 | 8 | 8 | | | | | | | 3 | 5 | | | | | | | | |
| 68pF(680) | | 2 | 2 | | 3 | 3,5 | 8 | 8 | | | | | | | 3 | 5 | | | | | | | | |
| 82pF(820) | | 2 | 2 | | 3 | 3,5 | 8 | 8 | | | | | | | 3 | 5 | | | | | | | | |
| 100pF(101) | | 2 | 2 | | 3 | 3,5 | 8 | 8 | 6 | | | | | | 3 | 5 | | | | | | | | |
| 120pF(121) | | | | | 3,5 | 8 | 8 | 6 | | | | | | | | 5 | | | | | | | | |
| 150pF(151) | | | | | 3,5 | 8 | 8 | 6 | | | | | | | | 5 | | | | | | | | |
| 180pF(181) | | | | | 3,5 | 8 | 8 | 6 | | | | | | | | 5 | | | | | | | | |
| 220pF(221) | | | | | 3,5 | 8 | 8 | 6 | | | | | | | | | | | | | | | | |
| 270pF(271) | | | | | 3,5 | 8 | 8 | 6 | | | | | | | | | | | | | | | | |
| 330pF(331) | | | | | 3,5 | 8 | 8 | 6 | | | | | | | | | | | | | | | | |
| 390pF(391) | | | | | 3,5 | 8 | 8 | 6 | | | | | | | | | | | | | | | | |
| 470pF(471) | | | | | 3,5 | 8 | 8 | 6 | | | | | | | | | | | | | | | | |
| 560pF(561) | | | | | 3,5 | 8 | 8 | 6 | | | | | | | | | | | | | | | | |
| 680pF(681) | | | | | 3,5 | 8 | 8 | 6 | | | | | | | | | | | | | | | | |
| 820pF(821) | | | | | 5 | 8 | 8 | 6 | | | | | | | | | | | | | | | | |
| 1000pF(102) | | | | | 5 | 8 | 8 | 6 | | | | | | | | | | | | | | | | |
| 1200pF(122) | | | | | | 8 | 8 | 6 | 6 | | | | | | | | | | | | | | | |
| 1500pF(152) | | | | | | 8 | 8 | 6 | 6 | | | | | | | | | | | | | | | |
| 1800pF(182) | | | | | | | 8 | 6 | 6 | 9 | | | | | | | | | | | | | | |
| 2200pF(222) | | | | | | | 8 | 6 | 6 | 9 | | | | | | | | | | | | | | |
| 2700pF(272) | | | | | | | 8 | 6 | 6 | 9 | | | | | | | | | | | | | | |
| 3300pF(332) | | | | | | | 8 | 6 | 6 | 9 | | | | | | | | | | | | | | |
| 3900pF(392) | | | | | | | 8 | | | 6 | 9 | | | | | | | | | | | | | |
| 4700pF(472) | | | | | | | | | | 6 | 9 | 9 | | | | | | | | | | | | |
| 5600pF(562) | | | | | | | | | | 9 | 9 | 9 | | | | | | | | | | | | |
| 6800pF(682) | | | | | | | | | | 9 | 9 | 9 | | | | | | | | | | | | |
| 8200pF(822) | | | | | | | | | | 9 | 9 | 9 | | | | | | | | | | | | |
| 10000pF(103) | | | | | | | | | | 9 | 9 | 9 | | | | | | | | | | | | |
| 12000pF(123) | | | | | | | | | | 9 | 9 | 9 | | | | | | | | | | | | |
| 15000pF(153) | | | | | | | | | | 9 | 9 | 9 | | | | | | | | | | | | |
| 18000pF(183) | | | | | | | | | | B | 9 | 9 | | | | | | | | | | | | |
| 22000pF(223) | | | | | | | | | | B | 9 | 9 | | | | | | | | | | | | |
| 27000pF(273) | | | | | | | | | | | 9 | | | | | | | | | | | | | |
| 33000pF(333) | | | | | | | | | | | 9 | | | | | | | | | | | | | |
| 39000pF(393) | | | | | | | | | | | 9 | | | | | | | | | | | | | |
| 47000pF(473) | | | | | | | | | | | M | | | | | | | | | | | | | |
| 56000pF(563) | | | | | | | | | | | M | | | | | | | | | | | 9 | 9 | |
| 68000pF(683) | | | | | | | | | | | C | | | | | | | | | | | B | M | |
| 82000pF(823) | | | | | | | | | | | C | | | | | | | | | | | B | M | |
| 0.1μF(104) | | | | | | | | | | | C | | | | | | | | | | | B | M | |

The part number code is shown in () and Unit is shown in []. < >: EIA [inch] Code

Capacitance Table

Temperature Compensating Type P2H(6P),R2H(6R),S2H(6S),T2H(6T) Characteristics

| 6 | | ex.6: T Dimension [mm] | | | | | | | |
|------------------------|-------------|---------------------------|---------------------------|---------------------------|---------------------------|---------------------------|---------------------------|---------------------------|---------------------------|
| TC | LxW [mm] | P2H (6P) | | R2H (6R) | | S2H (6S) | | T2H (6T) | |
| | | 1.0x0.5 (15) <0402> | 0.6x0.3 (03) <0201> | 1.0x0.5 (15) <0402> | 0.6x0.3 (03) <0201> | 1.0x0.5 (15) <0402> | 0.6x0.3 (03) <0201> | 1.0x0.5 (15) <0402> | 0.6x0.3 (03) <0201> |
| Rated Voltage [Vdc] | | 50 (1H) | 25 (1E) | 50 (1H) | 25 (1E) | 50 (1H) | 25 (1E) | 50 (1H) | 25 (1E) |
| Capacitance | | | | | | | | | |
| 1.0pF(1R0) | 5 | 3 | 5 | 3 | 5 | 3 | 5 | 3 | 5 |
| 2.0pF(2R0) | 5 | 3 | 5 | 3 | 5 | 3 | 5 | 3 | 5 |
| 3.0pF(3R0) | 5 | 3 | 5 | 3 | 5 | 3 | 5 | 3 | 5 |
| 4.0pF(4R0) | 5 | 3 | 5 | 3 | 5 | 3 | 5 | 3 | 5 |
| 5.0pF(5R0) | 5 | 3 | 5 | 3 | 5 | 3 | 5 | 3 | 5 |
| 6.0pF(6R0) | 5 | 3 | 5 | 3 | 5 | 3 | 5 | 3 | 5 |
| 7.0pF(7R0) | 5 | 3 | 5 | 3 | 5 | 3 | 5 | 3 | 5 |
| 8.0pF(8R0) | 5 | 3 | 5 | 3 | 5 | 3 | 5 | 3 | 5 |
| 9.0pF(9R0) | 5 | 3 | 5 | 3 | 5 | 3 | 5 | 3 | 5 |
| 10pF(100) | 5 | 3 | 5 | 3 | 5 | 3 | 5 | 3 | 5 |
| 12pF(120) | 5 | 3 | 5 | 3 | 5 | 3 | 5 | 3 | 5 |
| 15pF(150) | 5 | 3 | 5 | 3 | 5 | 3 | 5 | 3 | 5 |
| 18pF(180) | 5 | 3 | 5 | 3 | 5 | 3 | 5 | 3 | 5 |
| 22pF(220) | 5 | 3 | 5 | 3 | 5 | 3 | 5 | 3 | 5 |
| 27pF(270) | 5 | 3 | 5 | 3 | 5 | 3 | 5 | 3 | 5 |
| 33pF(330) | | 3 | 5 | 3 | 5 | 3 | 5 | 3 | 5 |
| 39pF(390) | | 3 | | 3 | 5 | 3 | 5 | 3 | 5 |
| 47pF(470) | | 3 | | 3 | | 3 | 5 | 3 | 5 |
| 56pF(560) | | 3 | | 3 | | 3 | | 3 | 5 |
| 68pF(680) | | 3 | | 3 | | 3 | | 3 | 5 |
| 82pF(820) | | 3 | | 3 | | 3 | | 3 | 5 |
| 100pF(101) | | 3 | | 3 | | 3 | | 3 | 5 |

The part number code is shown in () and Unit is shown in []. < >: EIA [inch] Code

For General
GRM Series

Array
GMM Series

Low ESL
LL□ Series

High-Q
GJM Series

High Frequency
GOM Series

Monolithic Microchip
GMA Series

For Bonding
GMD Series

Product Information

Capacitance Table

Continued from the preceding page.

High Dielectric Constant Type X7R(R7)/X7S(C7)/X7T(D7)/X7U(E7) Characteristics

| 5 | | ex.5: T Dimension [mm] | | | | | | | | | | | | | | | | | | | |
|--------------|----------|------------------------|---------|---------|---------|----------|---------------------|---------|---------|---------|---------|---------------------|---------|---------|---------|---------|---------------------|--------|--|--|--|
| Capacitance | LxW [mm] | 0.4x0.2 (02) <01005> | | | | | 0.6x0.3 (03) <0201> | | | | | 1.0x0.5 (15) <0402> | | | | | 1.6x0.8 (18) <0603> | | | | |
| | | 10 (1A) | 25 (1E) | 16 (1C) | 10 (1A) | 6.3 (0J) | 100 (2A) | 50 (1H) | 25 (1E) | 16 (1C) | 10 (1A) | 100 (2A) | 50 (1H) | 25 (1E) | 16 (1C) | 10 (1A) | 6.3 (0J) | 4 (0G) | | | |
| 68pF(680) | | 2 | | | | | | | | | | | | | | | | | | | |
| 100pF(101) | | 2 | 3 | 3 | | | | | | | | | | | | | | | | | |
| 150pF(151) | | 2 | 3 | 3 | | | | | | | | | | | | | | | | | |
| 220pF(221) | | 2 | 3 | 3 | | | | 5 | X, 5 | | | | | 8 | 8 | | | | | | |
| 330pF(331) | | 2 | 3 | 3 | | | | 5 | X, 5 | | | | | 8 | 8 | | | | | | |
| 470pF(471) | | 2 | 3 | 3 | | | | 5 | X, 5 | | | | | 8 | 8 | | | | | | |
| 680pF(681) | | | 3 | 3 | | | | 5 | X, 5 | | | | | 8 | 8 | | | | | | |
| 1000pF(102) | | | 3 | 3 | | | | 5 | X, 5 | | | | | 8 | 8 | | | | | | |
| 1500pF(152) | | | 3 | 3 | | | | 5 | X, 5 | | | | | 8 | 8 | | | | | | |
| 2200pF(222) | | | | 3 | 3 | | | 5 | 5 | X | | | | 8 | 8 | 8 | | | | | |
| 3300pF(332) | | | | 3 | 3 | | | 5 | 5 | | X | | | 8 | 8 | 8 | | | | | |
| 4700pF(472) | | | | | 3 | 3 | | 5 | 5 | 5 | X | | | 8 | 8 | 8 | | | | | |
| 6800pF(682) | | | | | 3 | 3 | | | 5 | 5 | X | | | 8 | 8 | 8 | | | | | |
| 10000pF(103) | | | | | 3 | 3 | | | 5 | 5 | X | | | 8 | 8 | 8 | | | | | |
| 15000pF(153) | | | | | | | | | 5 | 5 | 5 | | | | 8 | 8 | | | | | |
| 22000pF(223) | | | | | | | | | 5 | 5 | 5 | | | | 8 | 8 | | | | | |
| 33000pF(333) | | | | | | | | | | 5 | 5 | | | | 8 | 8 | | | | | |
| 47000pF(473) | | | | | | | | | | 5 | 5 | | | | 8 | 8 | | | | | |
| 68000pF(683) | | | | | | | | | | | 5 | 5 | | | 8 | 8 | | | | | |
| 0.10μF(104) | | | | | | | | | | | 5 | 5 | 8 | 8 | 8 | | | | | | |
| 0.15μF(154) | | | | | | | | | | | 5 | | | | 8 | 8 | | | | | |
| 0.22μF(224) | | | | | | | | | | | 5 | | | | 8 | 8 | | | | | |
| 0.33μF(334) | | | | | | | | | | | | | | | 8 | 8 | | | | | |
| 0.47μF(474) | | | | | | | | | | | | | | | 8 | 8 | 8 | | | | |
| 0.68μF(684) | | | | | | | | | | | | | | | 8 | 8 | | | | | |
| 1.0μF(105) | | | | | | | | | | | | | | | 8 | 8 | 5, 8 | | | | |
| 2.2μF(225) | | | | | | | | | | | | | | | | 8 | 8 | 8 | | | |

The part number code is shown in () and Unit is shown in []. < >: EIA [inch] Code

Continued on the following page. 

For General GRM Series

Array GNM Series

Low ESL LL□ Series

High-Q GJM Series

High Frequency GOM Series

Monolithic Microchip GMA Series

For Bonding GMD Series

Product Information

Capacitance Table

Continued from the preceding page.

| LxW [mm] | 2.0x1.25 (21) <0805> | | | | | | | 3.2x1.6 (31) <1206> | | | | | | | 3.2x2.5 (32) <1210> | | | | | | | | | | | |
|---------------------|----------------------|---------|---------|---------|---------|----------|--------|---------------------|---------|---------|---------|---------|----------|--------|---------------------|---------|---------|---------|---------|---------|----------|--------|--|---|--|--|
| | 100 (2A) | 50 (1H) | 25 (1E) | 16 (1C) | 10 (1A) | 6.3 (0J) | 4 (0G) | 100 (2A) | 50 (1H) | 25 (1E) | 16 (1C) | 10 (1A) | 6.3 (0J) | 4 (0G) | 100 (2A) | 50 (1H) | 35 (YA) | 25 (1E) | 16 (1C) | 10 (1A) | 6.3 (0J) | 4 (0G) | | | | |
| Rated Voltage [Vdc] | | | | | | | | | | | | | | | | | | | | | | | | | | |
| Capacitance | | | | | | | | | | | | | | | | | | | | | | | | | | |
| 6800pF(682) | 9 | | | | | | | | | | | | | | | | | | | | | | | | | |
| 10000pF(103) | B | | | | | | | | | | | | | | | | | | | | | | | | | |
| 15000pF(153) | B | | | | | | | | | | | | | | | | | | | | | | | | | |
| 22000pF(223) | B | | | | | | | | | | | | | | | | | | | | | | | | | |
| 33000pF(333) | B | 9 | | | | | | | | | | | | | | | | | | | | | | | | |
| 47000pF(473) | B | B | | | | | | | | | | | | | | | | | | | | | | | | |
| 68000pF(683) | | B | 9 | | | | | | | | | | | | | | | | | | | | | | | |
| 0.10μF(104) | | B | B | | | | | | | | | | | | | | | | | | | | | | | |
| 0.15μF(154) | | B | B | | | | | | | | | | | | | | | | | | | | | | | |
| 0.22μF(224) | A | B | B | | | | | | | | | | | | | | | | | | | | | | | |
| 0.33μF(334) | A | 9 | B | | | | | | | | | | | | | | | | | | | | | | | |
| 0.47μF(474) | B | B | 9 | | | | | | | | | | | | | | | | | | | | | | | |
| 0.68μF(684) | | | 9 | 9 | | | | | | | | | | | | | | | | C | | | | | | |
| 1.0μF(105) | | B | 9, B | B | | | | | | | | | | | | | | C | | | | | | | | |
| 2.2μF(225) | | | B | B | B | | | | | | | | | | | | E | | | | | | | | | |
| 4.7μF(475) | | | | B | B | | | | | | | | | | | | E | | | | | | | | | |
| 10μF(106) | | | | | B | B | | | | | | | | | C | C | C | | | | E | D | | | | |
| 22μF(226) | | | | | | B | | | | | | | | C | C | | | | | E | E | E | | | | |
| 47μF(476) | | | | | | | B | | | | | | | | | C | | | | | E | E | | | | |
| 100μF(107) | | | | | | | | | | | | | | | | | C | | | | | | | E | | |

The part number code is shown in () and Unit is shown in []. < >: EIA [inch] Code

These Part Numbers have individual testing conditions on Durability of GRM Series Specifications and Test Methods (2). Please refer to P60.

High Dielectric Constant Type X6S(C8)/X6T(D8) Characteristics

| LxW [mm] | 0.6x0.3 (03) <0201> | | 1.0x0.5 (15) <0402> | | |
|---------------------|---------------------|--------|---------------------|----------|--------|
| | 6.3 (0J) | 4 (0G) | 25 (1E) | 6.3 (0J) | 4 (0G) |
| Rated Voltage [Vdc] | | | | | |
| Capacitance | | | | | |
| 15000pF(153) | 3 | 3 | | | |
| 22000pF(223) | 3 | 3 | | | |
| 33000pF(333) | 3 | 3 | | | |
| 47000pF(473) | 3 | 3 | | | |
| 68000pF(683) | | | 5 | | |
| 0.10μF(104) | | | 5 | | |
| 0.15μF(154) | | | | 5 | 5 |
| 0.22μF(224) | | | | 5 | 5 |
| 0.33μF(334) | | | | 5 | 5 |
| 0.47μF(474) | | | | 5 | 5 |
| 0.68μF(684) | | | | 5# | 5 |

| LxW [mm] | 1.6x0.8 (18) <0603> | | | | | 2.0x1.25 (21) <0805> | | | | | 3.2x1.6 (31) <1206> | | | | | 3.2x2.5 (32) <1210> | | | | | | | | |
|---------------------|---------------------|---------|----------|--------|----------|----------------------|---------|---------|----------|--------|---------------------|---------|---------|----------|--------|---------------------|---------|----------|--------|---|---|---|--|--|
| | 25 (1E) | 10 (1A) | 6.3 (0J) | 4 (0G) | 2.5 (0E) | 25 (1E) | 16 (1C) | 10 (1A) | 6.3 (0J) | 4 (0G) | 25 (1E) | 16 (1C) | 10 (1A) | 6.3 (0J) | 4 (0G) | 25 (1E) | 10 (1A) | 6.3 (0J) | 4 (0G) | | | | | |
| Rated Voltage [Vdc] | | | | | | | | | | | | | | | | | | | | | | | | |
| Capacitance | | | | | | | | | | | | | | | | | | | | | | | | |
| 1.0μF(105) | 8 | 5 | 5 | | | | | | | | | | | | | | | | 6 | | | | | |
| 2.2μF(225) | | 8 | 8 | | | | | | | | | | | | | | 9 | | | | | | | |
| 4.7μF(475) | | | | 8 | | B | B | 9 | 9 | | | | | | 9 | | | | | | | | | |
| 10μF(106) | | | | 8# | 8 | | | | | | B | 9, B | C | M | 9 | 9 | | | | | D | | | |
| 22μF(226) | | | | | | | | | | | B# | B | | | | C | C | | | E | N | | | |
| 47μF(476) | | | | | | | | | | | | | | | | C | C | | | E | E | | | |
| 100μF(107) | | | | | | | | | | | | | | | | | | C | | | E | E | | |

The part number code is shown in () and Unit is shown in []. < >: EIA [inch] Code

These Part Numbers have individual testing conditions on Durability of GRM Series Specifications and Test Methods (2). Please refer to P60.

Capacitance Table

Continued from the preceding page.

High Dielectric Constant Type X5R(R6) Characteristics

5 ex.5: T Dimension [mm] : Please refer to X7R(R7) etc. Characteristics.

| LxW [mm] | 0.4x0.2 (02) <01005> | | 0.6x0.3 (03) <0201> | | | | 1.0x0.5 (15) <0402> | | | | | | 1.6x0.8 (18) <0603> | | | | | | | |
|--------------|----------------------------|-------------|---------------------------|------------|------------|-------------|---------------------------|------------|------------|------------|------------|-------------|---------------------------|------------|------------|------------|------------|-------------|-----------|--|
| | 10 (1A) | 6.3 (0J) | 25 (1E) | 16 (1C) | 10 (1A) | 6.3 (0J) | 100 (2A) | 50 (1H) | 25 (1E) | 16 (1C) | 10 (1A) | 6.3 (0J) | 100 (2A) | 50 (1H) | 25 (1E) | 16 (1C) | 10 (1A) | 6.3 (0J) | 4 (0G) | |
| 68pF(680) | 2 | | | | | | | | | | | | | | | | | | | |
| 100pF(101) | 2 | | | | | | | | | | | | | | | | | | | |
| 150pF(151) | 2 | | | | | | | | | | | | | | | | | | | |
| 220pF(221) | 2 | | | | | | | | | | | | | | | | | | | |
| 330pF(331) | 2 | | | | | | | | | | | | | | | | | | | |
| 470pF(471) | 2 | | | | | | | | | | | | | | | | | | | |
| 680pF(681) | 2 | 2 | | | | | | | | | | | | | | | | | | |
| 1000pF(102) | 2 | 2 | | | | | | 5 | | | | | | 8 | | | | | | |
| 1500pF(152) | 2 | 2 | | | | 3 | | | | | | | | | | | | | | |
| 2200pF(222) | 2 | 2 | | | | 3 | | | 5 | | | | | 8 | | | | | | |
| 3300pF(332) | 2 | 2 | | | | 3 | | | | | | | | | | | | | | |
| 4700pF(472) | 2 | 2 | | | | 3 | | | 5 | | | | | 8 | | | | | | |
| 6800pF(682) | 2 | 2 | | | | 3 | | | | | | | | | | | | | | |
| 10000pF(103) | 2 | 2 | | | | 3 | 3 | | | | | | | 8 | | | | | | |
| 15000pF(153) | | | | | | | 3 | | | | | | | | | | | | | |
| 22000pF(223) | | | | | | | 3 | | | 5 | | | | 8 | | | | | | |
| 33000pF(333) | | | | | | | 3 | | | 5 | 5 | | | | | | | | | |
| 47000pF(473) | | | | | | | 3 | | | 5 | 5 | | | | | | | | | |
| 68000pF(683) | | | | | | | | | 5 | 5 | 5 | | | | | | | | | |
| 0.10μF(104) | | | | | | | | | 5 | 5 | 5 | | | | 8 | | | | | |
| 0.15μF(154) | | | | | | | | | | 5 | 5 | | | | | | | | | |
| 0.22μF(224) | | | | | | | | | | 5 | 5 | | | 8 | 8 | | | | | |
| 0.33μF(334) | | | | | | | | | | 5 | 5 | | | | | | | | | |
| 0.47μF(474) | | | | | | | | | | 5 | 5 | | | 8 | 8 | | | | | |
| 0.68μF(684) | | | | | | | | | | 5 | 5 | | | | | | | | | |
| 1.0μF(105) | | | | | | | | | | 5 | | | | 8 | 5, 8 | 5 | | | | |
| 2.2μF(225) | | | | | | | | | | | | | | | 8 | 8 | | | | |
| 4.7μF(475) | | | | | | | | | | | | | | | | | | 8 | | |
| 10μF(106) | | | | | | | | | | | | | | | | | | 8 | 8 | |
| 22μF(226) | | | | | | | | | | | | | | | | | | | 8 | |

The part number code is shown in () and Unit is shown in []. <>: EIA [inch] Code

Continued on the following page. ↗

For General GRM Series

Array GNM Series

Low ESL LL□ Series

High-Q GJM Series

High Frequency GOM Series

Monolithic Microchip GMA Series

For Bonding GMD Series

Product Information

Capacitance Table

Continued from the preceding page.

| LxW [mm] | 2.0x1.25 (21) <0805> | | | | | | | 3.2x1.6 (31) <1206> | | | | | | | 3.2x2.5 (32) <1210> | | | | | | | |
|------------------------|----------------------------|------------|------------|------------|------------|-------------|-----------|---------------------------|------------|------------|------------|------------|-------------|-----------|---------------------------|------------|------------|------------|------------|------------|-------------|-----------|
| | 100 (2A) | 50 (1H) | 25 (1E) | 16 (1C) | 10 (1A) | 6.3 (0J) | 4 (0G) | 100 (2A) | 50 (1H) | 25 (1E) | 16 (1C) | 10 (1A) | 6.3 (0J) | 4 (0G) | 100 (2A) | 50 (1H) | 35 (YA) | 25 (1E) | 16 (1C) | 10 (1A) | 6.3 (0J) | 4 (0G) |
| Rated Voltage [Vdc] | | | | | | | | | | | | | | | | | | | | | | |
| Capacitance | | | | | | | | | | | | | | | | | | | | | | |
| 6800pF(682) | | | | | | | | | | | | | | | | | | | | | | |
| 10000pF(103) | | | | | | | | | | | | | | | | | | | | | | |
| 15000pF(153) | | | | | | | | | | | | | | | | | | | | | | |
| 22000pF(223) | | | | | | | | | | | | | | | | | | | | | | |
| 33000pF(333) | | | | | | | | | | | | | | | | | | | | | | |
| 47000pF(473) | | | | | | | | | | | | | | | | | | | | | | |
| 68000pF(683) | | | | | | | | | | | | | | | | | | | | | | |
| 0.10μF(104) | | | | | | | | | | | | | | | | | | | | | | |
| 0.15μF(154) | | | | | | | | | | | | | | | | | | | | | | |
| 0.22μF(224) | | | | | | | | | | | | | | | | | | | | | | |
| 0.33μF(334) | | | | | | | | | | | | | | | | | | | | | | |
| 0.47μF(474) | | | | | | | | | | | | | | | | | | | | | | |
| 0.68μF(684) | | | | | | | | | | | | | | | | | | | | | | |
| 1.0μF(105) | | | | 6 | 6, B | | | | | | | | | | | | | | | | | |
| 2.2μF(225) | | | 9, B | 9, B | B | | | | | C | 6 | | | | | | | | | | | |
| 4.7μF(475) | | | B | 9, B | 9, B | B | | | | 9, C | 9, C | | | | | | | | | | | |
| 10μF(106) | | | | B | 9, B | 9, B | | | | C | 9, C | 9 | | | | | E | D | | | | |
| 22μF(226) | | | | | B | 9 | | | | C | C | C | | | | | E | | | | | |
| 47μF(476) | | | | | | | | | | | C | C | | | | | | E | E | | | |
| 100μF(107) | | | | | | | | | | | | C | C | | | | | | | | E | |

The part number code is shown in () and Unit is shown in []. < >: EIA [inch] Code

For General
GRM Series

Array
GMM Series

Low ESL
LL□ Series

High-Q
GJM Series

High Frequency
GOM Series

Monolithic Microchip
GMA Series

For Bonding
GMD Series

Product Information

Temperature Compensating Type C0G(5C) Characteristics

| LxW [mm] | | 0.4x0.2(02)<01005> | 0.6x0.3(03)<0201> | 1.0x0.5(15)<0402> |
|-------------------|------------|--------------------|--------------------|--------------------|
| Rated Volt. [Vdc] | | 16(1C) | 50(1H) | 50(1H) |
| Capacitance | Tolerance | Part Number | | |
| 0.1pF(R10) | ±0.05pF(W) | | GRM0335C1HR10WD01D | GRM1555C1HR10WA01D |
| | ±0.1pF(B) | | GRM0335C1HR10BD01D | GRM1555C1HR10BA01D |
| 0.2pF(R20) | ±0.05pF(W) | GRM0225C1CR20WD05L | GRM0335C1HR20WD01D | GRM1555C1HR20WA01D |
| | ±0.1pF(B) | GRM0225C1CR20BD05L | GRM0335C1HR20BD01D | GRM1555C1HR20BA01D |
| 0.3pF(R30) | ±0.05pF(W) | GRM0225C1CR30WD05L | GRM0335C1HR30WD01D | GRM1555C1HR30WA01D |
| | ±0.1pF(B) | GRM0225C1CR30BD05L | GRM0335C1HR30BD01D | GRM1555C1HR30BA01D |
| 0.4pF(R40) | ±0.05pF(W) | GRM0225C1CR40WD05L | GRM0335C1HR40WD01D | GRM1555C1HR40WA01D |
| | ±0.1pF(B) | GRM0225C1CR40BD05L | GRM0335C1HR40BD01D | GRM1555C1HR40BA01D |
| 0.5pF(R50) | ±0.05pF(W) | GRM0225C1CR50WD05L | GRM0335C1HR50WD01D | GRM1555C1HR50WA01D |
| | ±0.1pF(B) | GRM0225C1CR50BD05L | GRM0335C1HR50BD01D | GRM1555C1HR50BA01D |
| 0.6pF(R60) | ±0.05pF(W) | GRM0225C1CR60WD05L | GRM0335C1HR60WD01D | GRM1555C1HR60WA01D |
| | ±0.1pF(B) | GRM0225C1CR60BD05L | GRM0335C1HR60BD01D | GRM1555C1HR60BA01D |
| 0.7pF(R70) | ±0.05pF(W) | GRM0225C1CR70WD05L | GRM0335C1HR70WD01D | GRM1555C1HR70WA01D |
| | ±0.1pF(B) | GRM0225C1CR70BD05L | GRM0335C1HR70BD01D | GRM1555C1HR70BA01D |
| 0.8pF(R80) | ±0.05pF(W) | GRM0225C1CR80WD05L | GRM0335C1HR80WD01D | GRM1555C1HR80WA01D |
| | ±0.1pF(B) | GRM0225C1CR80BD05L | GRM0335C1HR80BD01D | GRM1555C1HR80BA01D |
| 0.9pF(R90) | ±0.05pF(W) | GRM0225C1CR90WD05L | GRM0335C1HR90WD01D | GRM1555C1HR90WA01D |
| | ±0.1pF(B) | GRM0225C1CR90BD05L | GRM0335C1HR90BD01D | GRM1555C1HR90BA01D |
| 1.0pF(1R0) | ±0.05pF(W) | GRM0225C1C1R0WD05L | GRM0335C1H1R0WD01D | GRM1555C1H1R0WA01D |
| | ±0.1pF(B) | GRM0225C1C1R0BD05L | GRM0335C1H1R0BD01D | GRM1555C1H1R0BA01D |
| | ±0.25pF(C) | GRM0225C1C1R0CD05L | GRM0335C1H1R0CD01D | GRM1555C1H1R0CA01D |
| 1.1pF(1R1) | ±0.05pF(W) | GRM0225C1C1R1WD05L | GRM0335C1H1R1WD01D | GRM1555C1H1R1WA01D |
| | ±0.1pF(B) | GRM0225C1C1R1BD05L | GRM0335C1H1R1BD01D | GRM1555C1H1R1BA01D |
| | ±0.25pF(C) | GRM0225C1C1R1CD05L | GRM0335C1H1R1CD01D | GRM1555C1H1R1CA01D |
| 1.2pF(1R2) | ±0.05pF(W) | GRM0225C1C1R2WD05L | GRM0335C1H1R2WD01D | GRM1555C1H1R2WA01D |
| | ±0.1pF(B) | GRM0225C1C1R2BD05L | GRM0335C1H1R2BD01D | GRM1555C1H1R2BA01D |
| | ±0.25pF(C) | GRM0225C1C1R2CD05L | GRM0335C1H1R2CD01D | GRM1555C1H1R2CA01D |
| 1.3pF(1R3) | ±0.05pF(W) | GRM0225C1C1R3WD05L | GRM0335C1H1R3WD01D | GRM1555C1H1R3WA01D |
| | ±0.1pF(B) | GRM0225C1C1R3BD05L | GRM0335C1H1R3BD01D | GRM1555C1H1R3BA01D |
| | ±0.25pF(C) | GRM0225C1C1R3CD05L | GRM0335C1H1R3CD01D | GRM1555C1H1R3CA01D |
| 1.4pF(1R4) | ±0.05pF(W) | GRM0225C1C1R4WD05L | GRM0335C1H1R4WD01D | GRM1555C1H1R4WA01D |
| | ±0.1pF(B) | GRM0225C1C1R4BD05L | GRM0335C1H1R4BD01D | GRM1555C1H1R4BA01D |
| | ±0.25pF(C) | GRM0225C1C1R4CD05L | GRM0335C1H1R4CD01D | GRM1555C1H1R4CA01D |
| 1.5pF(1R5) | ±0.05pF(W) | GRM0225C1C1R5WD05L | GRM0335C1H1R5WD01D | GRM1555C1H1R5WA01D |
| | ±0.1pF(B) | GRM0225C1C1R5BD05L | GRM0335C1H1R5BD01D | GRM1555C1H1R5BA01D |
| | ±0.25pF(C) | GRM0225C1C1R5CD05L | GRM0335C1H1R5CD01D | GRM1555C1H1R5CA01D |
| 1.6pF(1R6) | ±0.05pF(W) | GRM0225C1C1R6WD05L | GRM0335C1H1R6WD01D | GRM1555C1H1R6WA01D |
| | ±0.1pF(B) | GRM0225C1C1R6BD05L | GRM0335C1H1R6BD01D | GRM1555C1H1R6BA01D |
| | ±0.25pF(C) | GRM0225C1C1R6CD05L | GRM0335C1H1R6CD01D | GRM1555C1H1R6CA01D |
| 1.7pF(1R7) | ±0.05pF(W) | GRM0225C1C1R7WD05L | GRM0335C1H1R7WD01D | GRM1555C1H1R7WA01D |
| | ±0.1pF(B) | GRM0225C1C1R7BD05L | GRM0335C1H1R7BD01D | GRM1555C1H1R7BA01D |
| | ±0.25pF(C) | GRM0225C1C1R7CD05L | GRM0335C1H1R7CD01D | GRM1555C1H1R7CA01D |
| 1.8pF(1R8) | ±0.05pF(W) | GRM0225C1C1R8WD05L | GRM0335C1H1R8WD01D | GRM1555C1H1R8WA01D |
| | ±0.1pF(B) | GRM0225C1C1R8BD05L | GRM0335C1H1R8BD01D | GRM1555C1H1R8BA01D |
| | ±0.25pF(C) | GRM0225C1C1R8CD05L | GRM0335C1H1R8CD01D | GRM1555C1H1R8CA01D |
| 1.9pF(1R9) | ±0.05pF(W) | GRM0225C1C1R9WD05L | GRM0335C1H1R9WD01D | GRM1555C1H1R9WA01D |
| | ±0.1pF(B) | GRM0225C1C1R9BD05L | GRM0335C1H1R9BD01D | GRM1555C1H1R9BA01D |
| | ±0.25pF(C) | GRM0225C1C1R9CD05L | GRM0335C1H1R9CD01D | GRM1555C1H1R9CA01D |

The part number code is shown in () and Unit is shown in []. < >: EIA [inch] Code

(Part Number) **GR** **M** **02** **2** **5C** **1C** **R20** **W** **D05** **L** **1** **2** **3** **4** **5** **6** **7** **8** **9** **10**

① Product ID ② Series ③ Dimensions (LxW) ④ Dimension (T)
 ⑤ Temperature Characteristics ⑥ Rated Voltage ⑦ Capacitance
 ⑧ Capacitance Tolerance ⑨ Individual Specification Code ⑩ Packaging*

Packaging Code in Part Number shows STD 180mm Reel Taping.

*GRM022: D is applicable.

For General GRM Series
Array GNM Series
Low ESL LL□ Series
High-Q GJM Series
High Frequency GQM Series
Monolithic Microchip GMA Series
For Bonding GMD Series
Product Information

Temperature Compensating Type C0G(5C) Characteristics

| LxW [mm] | | 0.4x0.2(02)<01005> | 0.6x0.3(03)<0201> | 1.0x0.5(15)<0402> |
|-------------------|------------|--------------------|--------------------|--------------------|
| Rated Volt. [Vdc] | | 16(1C) | 50(1H) | 50(1H) |
| Capacitance | Tolerance | Part Number | | |
| 2.0pF(2R0) | ±0.05pF(W) | GRM0225C1C2R0WD05L | GRM0335C1H2R0WD01D | GRM1555C1H2R0WA01D |
| | ±0.1pF(B) | GRM0225C1C2R0BD05L | GRM0335C1H2R0BD01D | GRM1555C1H2R0BA01D |
| | ±0.25pF(C) | GRM0225C1C2R0CD05L | GRM0335C1H2R0CD01D | GRM1555C1H2R0CA01D |
| 2.1pF(2R1) | ±0.05pF(W) | GRM0225C1C2R1WD05L | GRM0335C1H2R1WD01D | GRM1555C1H2R1WA01D |
| | ±0.1pF(B) | GRM0225C1C2R1BD05L | GRM0335C1H2R1BD01D | GRM1555C1H2R1BA01D |
| | ±0.25pF(C) | GRM0225C1C2R1CD05L | GRM0335C1H2R1CD01D | GRM1555C1H2R1CA01D |
| 2.2pF(2R2) | ±0.05pF(W) | GRM0225C1C2R2WD05L | GRM0335C1H2R2WD01D | GRM1555C1H2R2WA01D |
| | ±0.1pF(B) | GRM0225C1C2R2BD05L | GRM0335C1H2R2BD01D | GRM1555C1H2R2BA01D |
| | ±0.25pF(C) | GRM0225C1C2R2CD05L | GRM0335C1H2R2CD01D | GRM1555C1H2R2CA01D |
| 2.3pF(2R3) | ±0.05pF(W) | GRM0225C1C2R3WD05L | GRM0335C1H2R3WD01D | GRM1555C1H2R3WA01D |
| | ±0.1pF(B) | GRM0225C1C2R3BD05L | GRM0335C1H2R3BD01D | GRM1555C1H2R3BA01D |
| | ±0.25pF(C) | GRM0225C1C2R3CD05L | GRM0335C1H2R3CD01D | GRM1555C1H2R3CA01D |
| 2.4pF(2R4) | ±0.05pF(W) | GRM0225C1C2R4WD05L | GRM0335C1H2R4WD01D | GRM1555C1H2R4WA01D |
| | ±0.1pF(B) | GRM0225C1C2R4BD05L | GRM0335C1H2R4BD01D | GRM1555C1H2R4BA01D |
| | ±0.25pF(C) | GRM0225C1C2R4CD05L | GRM0335C1H2R4CD01D | GRM1555C1H2R4CA01D |
| 2.5pF(2R5) | ±0.05pF(W) | GRM0225C1C2R5WD05L | GRM0335C1H2R5WD01D | GRM1555C1H2R5WA01D |
| | ±0.1pF(B) | GRM0225C1C2R5BD05L | GRM0335C1H2R5BD01D | GRM1555C1H2R5BA01D |
| | ±0.25pF(C) | GRM0225C1C2R5CD05L | GRM0335C1H2R5CD01D | GRM1555C1H2R5CA01D |
| 2.6pF(2R6) | ±0.05pF(W) | GRM0225C1C2R6WD05L | GRM0335C1H2R6WD01D | GRM1555C1H2R6WA01D |
| | ±0.1pF(B) | GRM0225C1C2R6BD05L | GRM0335C1H2R6BD01D | GRM1555C1H2R6BA01D |
| | ±0.25pF(C) | GRM0225C1C2R6CD05L | GRM0335C1H2R6CD01D | GRM1555C1H2R6CA01D |
| 2.7pF(2R7) | ±0.05pF(W) | GRM0225C1C2R7WD05L | GRM0335C1H2R7WD01D | GRM1555C1H2R7WA01D |
| | ±0.1pF(B) | GRM0225C1C2R7BD05L | GRM0335C1H2R7BD01D | GRM1555C1H2R7BA01D |
| | ±0.25pF(C) | GRM0225C1C2R7CD05L | GRM0335C1H2R7CD01D | GRM1555C1H2R7CA01D |
| 2.8pF(2R8) | ±0.05pF(W) | GRM0225C1C2R8WD05L | GRM0335C1H2R8WD01D | GRM1555C1H2R8WA01D |
| | ±0.1pF(B) | GRM0225C1C2R8BD05L | GRM0335C1H2R8BD01D | GRM1555C1H2R8BA01D |
| | ±0.25pF(C) | GRM0225C1C2R8CD05L | GRM0335C1H2R8CD01D | GRM1555C1H2R8CA01D |
| 2.9pF(2R9) | ±0.05pF(W) | GRM0225C1C2R9WD05L | GRM0335C1H2R9WD01D | GRM1555C1H2R9WA01D |
| | ±0.1pF(B) | GRM0225C1C2R9BD05L | GRM0335C1H2R9BD01D | GRM1555C1H2R9BA01D |
| | ±0.25pF(C) | GRM0225C1C2R9CD05L | GRM0335C1H2R9CD01D | GRM1555C1H2R9CA01D |
| 3.0pF(3R0) | ±0.05pF(W) | GRM0225C1C3R0WD05L | GRM0335C1H3R0WD01D | GRM1555C1H3R0WA01D |
| | ±0.1pF(B) | GRM0225C1C3R0BD05L | GRM0335C1H3R0BD01D | GRM1555C1H3R0BA01D |
| | ±0.25pF(C) | GRM0225C1C3R0CD05L | GRM0335C1H3R0CD01D | GRM1555C1H3R0CA01D |
| 3.1pF(3R1) | ±0.05pF(W) | GRM0225C1C3R1WD05L | GRM0335C1H3R1WD01D | GRM1555C1H3R1WA01D |
| | ±0.1pF(B) | GRM0225C1C3R1BD05L | GRM0335C1H3R1BD01D | GRM1555C1H3R1BA01D |
| | ±0.25pF(C) | GRM0225C1C3R1CD05L | GRM0335C1H3R1CD01D | GRM1555C1H3R1CA01D |
| 3.2pF(3R2) | ±0.05pF(W) | GRM0225C1C3R2WD05L | GRM0335C1H3R2WD01D | GRM1555C1H3R2WA01D |
| | ±0.1pF(B) | GRM0225C1C3R2BD05L | GRM0335C1H3R2BD01D | GRM1555C1H3R2BA01D |
| | ±0.25pF(C) | GRM0225C1C3R2CD05L | GRM0335C1H3R2CD01D | GRM1555C1H3R2CA01D |
| 3.3pF(3R3) | ±0.05pF(W) | GRM0225C1C3R3WD05L | GRM0335C1H3R3WD01D | GRM1555C1H3R3WA01D |
| | ±0.1pF(B) | GRM0225C1C3R3BD05L | GRM0335C1H3R3BD01D | GRM1555C1H3R3BA01D |
| | ±0.25pF(C) | GRM0225C1C3R3CD05L | GRM0335C1H3R3CD01D | GRM1555C1H3R3CA01D |
| 3.4pF(3R4) | ±0.05pF(W) | GRM0225C1C3R4WD05L | GRM0335C1H3R4WD01D | GRM1555C1H3R4WA01D |
| | ±0.1pF(B) | GRM0225C1C3R4BD05L | GRM0335C1H3R4BD01D | GRM1555C1H3R4BA01D |
| | ±0.25pF(C) | GRM0225C1C3R4CD05L | GRM0335C1H3R4CD01D | GRM1555C1H3R4CA01D |
| 3.5pF(3R5) | ±0.05pF(W) | GRM0225C1C3R5WD05L | GRM0335C1H3R5WD01D | GRM1555C1H3R5WA01D |
| | ±0.1pF(B) | GRM0225C1C3R5BD05L | GRM0335C1H3R5BD01D | GRM1555C1H3R5BA01D |
| | ±0.25pF(C) | GRM0225C1C3R5CD05L | GRM0335C1H3R5CD01D | GRM1555C1H3R5CA01D |

The part number code is shown in () and Unit is shown in []. < >: EIA [inch] Code

(Part Number) **GR** **M** **02** **2** **5C** **1C** **2R0** **W** **D05** **L** **1** **2** **3** **4** **5** **6** **7** **8** **9** **10**

① Product ID ② Series ③ Dimensions (LxW) ④ Dimension (T)
 ⑤ Temperature Characteristics ⑥ Rated Voltage ⑦ Capacitance
 ⑧ Capacitance Tolerance ⑨ Individual Specification Code ⑩ Packaging*

Packaging Code in Part Number shows STD 180mm Reel Taping.

*GRM022: D is applicable.

Temperature Compensating Type C0G(5C) Characteristics

| LxW [mm] | | 0.4x0.2(02)<01005> | 0.6x0.3(03)<0201> | 1.0x0.5(15)<0402> |
|-------------------|------------|--------------------|--------------------|--------------------|
| Rated Volt. [Vdc] | | 16(1C) | 50(1H) | 50(1H) |
| Capacitance | Tolerance | Part Number | | |
| 3.6pF(3R6) | ±0.05pF(W) | GRM0225C1C3R6WD05L | GRM0335C1H3R6WD01D | GRM1555C1H3R6WA01D |
| | ±0.1pF(B) | GRM0225C1C3R6BD05L | GRM0335C1H3R6BD01D | GRM1555C1H3R6BA01D |
| | ±0.25pF(C) | GRM0225C1C3R6CD05L | GRM0335C1H3R6CD01D | GRM1555C1H3R6CA01D |
| 3.7pF(3R7) | ±0.05pF(W) | GRM0225C1C3R7WD05L | GRM0335C1H3R7WD01D | GRM1555C1H3R7WA01D |
| | ±0.1pF(B) | GRM0225C1C3R7BD05L | GRM0335C1H3R7BD01D | GRM1555C1H3R7BA01D |
| | ±0.25pF(C) | GRM0225C1C3R7CD05L | GRM0335C1H3R7CD01D | GRM1555C1H3R7CA01D |
| 3.8pF(3R8) | ±0.05pF(W) | GRM0225C1C3R8WD05L | GRM0335C1H3R8WD01D | GRM1555C1H3R8WA01D |
| | ±0.1pF(B) | GRM0225C1C3R8BD05L | GRM0335C1H3R8BD01D | GRM1555C1H3R8BA01D |
| | ±0.25pF(C) | GRM0225C1C3R8CD05L | GRM0335C1H3R8CD01D | GRM1555C1H3R8CA01D |
| 3.9pF(3R9) | ±0.05pF(W) | GRM0225C1C3R9WD05L | GRM0335C1H3R9WD01D | GRM1555C1H3R9WA01D |
| | ±0.1pF(B) | GRM0225C1C3R9BD05L | GRM0335C1H3R9BD01D | GRM1555C1H3R9BA01D |
| | ±0.25pF(C) | GRM0225C1C3R9CD05L | GRM0335C1H3R9CD01D | GRM1555C1H3R9CA01D |
| 4.0pF(4R0) | ±0.05pF(W) | GRM0225C1C4R0WD05L | GRM0335C1H4R0WD01D | GRM1555C1H4R0WA01D |
| | ±0.1pF(B) | GRM0225C1C4R0BD05L | GRM0335C1H4R0BD01D | GRM1555C1H4R0BA01D |
| | ±0.25pF(C) | GRM0225C1C4R0CD05L | GRM0335C1H4R0CD01D | GRM1555C1H4R0CA01D |
| 4.1pF(4R1) | ±0.05pF(W) | GRM0225C1C4R1WD05L | GRM0335C1H4R1WD01D | GRM1555C1H4R1WA01D |
| | ±0.1pF(B) | GRM0225C1C4R1BD05L | GRM0335C1H4R1BD01D | GRM1555C1H4R1BA01D |
| | ±0.25pF(C) | GRM0225C1C4R1CD05L | GRM0335C1H4R1CD01D | GRM1555C1H4R1CA01D |
| 4.2pF(4R2) | ±0.05pF(W) | GRM0225C1C4R2WD05L | GRM0335C1H4R2WD01D | GRM1555C1H4R2WA01D |
| | ±0.1pF(B) | GRM0225C1C4R2BD05L | GRM0335C1H4R2BD01D | GRM1555C1H4R2BA01D |
| | ±0.25pF(C) | GRM0225C1C4R2CD05L | GRM0335C1H4R2CD01D | GRM1555C1H4R2CA01D |
| 4.3pF(4R3) | ±0.05pF(W) | GRM0225C1C4R3WD05L | GRM0335C1H4R3WD01D | GRM1555C1H4R3WA01D |
| | ±0.1pF(B) | GRM0225C1C4R3BD05L | GRM0335C1H4R3BD01D | GRM1555C1H4R3BA01D |
| | ±0.25pF(C) | GRM0225C1C4R3CD05L | GRM0335C1H4R3CD01D | GRM1555C1H4R3CA01D |
| 4.4pF(4R4) | ±0.05pF(W) | GRM0225C1C4R4WD05L | GRM0335C1H4R4WD01D | GRM1555C1H4R4WA01D |
| | ±0.1pF(B) | GRM0225C1C4R4BD05L | GRM0335C1H4R4BD01D | GRM1555C1H4R4BA01D |
| | ±0.25pF(C) | GRM0225C1C4R4CD05L | GRM0335C1H4R4CD01D | GRM1555C1H4R4CA01D |
| 4.5pF(4R5) | ±0.05pF(W) | GRM0225C1C4R5WD05L | GRM0335C1H4R5WD01D | GRM1555C1H4R5WA01D |
| | ±0.1pF(B) | GRM0225C1C4R5BD05L | GRM0335C1H4R5BD01D | GRM1555C1H4R5BA01D |
| | ±0.25pF(C) | GRM0225C1C4R5CD05L | GRM0335C1H4R5CD01D | GRM1555C1H4R5CA01D |
| 4.6pF(4R6) | ±0.05pF(W) | GRM0225C1C4R6WD05L | GRM0335C1H4R6WD01D | GRM1555C1H4R6WA01D |
| | ±0.1pF(B) | GRM0225C1C4R6BD05L | GRM0335C1H4R6BD01D | GRM1555C1H4R6BA01D |
| | ±0.25pF(C) | GRM0225C1C4R6CD05L | GRM0335C1H4R6CD01D | GRM1555C1H4R6CA01D |
| 4.7pF(4R7) | ±0.05pF(W) | GRM0225C1C4R7WD05L | GRM0335C1H4R7WD01D | GRM1555C1H4R7WA01D |
| | ±0.1pF(B) | GRM0225C1C4R7BD05L | GRM0335C1H4R7BD01D | GRM1555C1H4R7BA01D |
| | ±0.25pF(C) | GRM0225C1C4R7CD05L | GRM0335C1H4R7CD01D | GRM1555C1H4R7CA01D |
| 4.8pF(4R8) | ±0.05pF(W) | GRM0225C1C4R8WD05L | GRM0335C1H4R8WD01D | GRM1555C1H4R8WA01D |
| | ±0.1pF(B) | GRM0225C1C4R8BD05L | GRM0335C1H4R8BD01D | GRM1555C1H4R8BA01D |
| | ±0.25pF(C) | GRM0225C1C4R8CD05L | GRM0335C1H4R8CD01D | GRM1555C1H4R8CA01D |
| 4.9pF(4R9) | ±0.05pF(W) | GRM0225C1C4R9WD05L | GRM0335C1H4R9WD01D | GRM1555C1H4R9WA01D |
| | ±0.1pF(B) | GRM0225C1C4R9BD05L | GRM0335C1H4R9BD01D | GRM1555C1H4R9BA01D |
| | ±0.25pF(C) | GRM0225C1C4R9CD05L | GRM0335C1H4R9CD01D | GRM1555C1H4R9CA01D |
| 5.0pF(5R0) | ±0.05pF(W) | GRM0225C1C5R0WD05L | GRM0335C1H5R0WD01D | GRM1555C1H5R0WA01D |
| | ±0.1pF(B) | GRM0225C1C5R0BD05L | GRM0335C1H5R0BD01D | GRM1555C1H5R0BA01D |
| | ±0.25pF(C) | GRM0225C1C5R0CD05L | GRM0335C1H5R0CD01D | GRM1555C1H5R0CA01D |
| 5.1pF(5R1) | ±0.05pF(W) | GRM0225C1C5R1WD05L | GRM0335C1H5R1WD01D | GRM1555C1H5R1WA01D |
| | ±0.1pF(B) | GRM0225C1C5R1BD05L | GRM0335C1H5R1BD01D | GRM1555C1H5R1BA01D |
| | ±0.25pF(C) | GRM0225C1C5R1CD05L | GRM0335C1H5R1CD01D | GRM1555C1H5R1CA01D |
| | ±0.5pF(D) | GRM0225C1C5R1DD05L | GRM0335C1H5R1DD01D | GRM1555C1H5R1DA01D |

The part number code is shown in () and Unit is shown in []. < >: EIA [inch] Code

For General GRM Series

Array GNM Series

Low ESL LL□ Series

High-Q GJM Series

High Frequency GQM Series

Monolithic Microchip GMA Series

For Bonding GMD Series

Product Information

Temperature Compensating Type C0G(5C) Characteristics

| LxW [mm] | | 0.4x0.2(02)<01005> | 0.6x0.3(03)<0201> | 1.0x0.5(15)<0402> |
|-------------------|------------|--------------------|--------------------|--------------------|
| Rated Volt. [Vdc] | | 16(1C) | 50(1H) | 50(1H) |
| Capacitance | Tolerance | Part Number | | |
| 5.2pF(5R2) | ±0.05pF(W) | GRM0225C1C5R2WD05L | GRM0335C1H5R2WD01D | GRM1555C1H5R2WA01D |
| | ±0.1pF(B) | GRM0225C1C5R2BD05L | GRM0335C1H5R2BD01D | GRM1555C1H5R2BA01D |
| | ±0.25pF(C) | GRM0225C1C5R2CD05L | GRM0335C1H5R2CD01D | GRM1555C1H5R2CA01D |
| | ±0.5pF(D) | GRM0225C1C5R2DD05L | GRM0335C1H5R2DD01D | GRM1555C1H5R2DA01D |
| 5.3pF(5R3) | ±0.05pF(W) | GRM0225C1C5R3WD05L | GRM0335C1H5R3WD01D | GRM1555C1H5R3WA01D |
| | ±0.1pF(B) | GRM0225C1C5R3BD05L | GRM0335C1H5R3BD01D | GRM1555C1H5R3BA01D |
| | ±0.25pF(C) | GRM0225C1C5R3CD05L | GRM0335C1H5R3CD01D | GRM1555C1H5R3CA01D |
| | ±0.5pF(D) | GRM0225C1C5R3DD05L | GRM0335C1H5R3DD01D | GRM1555C1H5R3DA01D |
| 5.4pF(5R4) | ±0.05pF(W) | GRM0225C1C5R4WD05L | GRM0335C1H5R4WD01D | GRM1555C1H5R4WA01D |
| | ±0.1pF(B) | GRM0225C1C5R4BD05L | GRM0335C1H5R4BD01D | GRM1555C1H5R4BA01D |
| | ±0.25pF(C) | GRM0225C1C5R4CD05L | GRM0335C1H5R4CD01D | GRM1555C1H5R4CA01D |
| | ±0.5pF(D) | GRM0225C1C5R4DD05L | GRM0335C1H5R4DD01D | GRM1555C1H5R4DA01D |
| 5.5pF(5R5) | ±0.05pF(W) | GRM0225C1C5R5WD05L | GRM0335C1H5R5WD01D | GRM1555C1H5R5WA01D |
| | ±0.1pF(B) | GRM0225C1C5R5BD05L | GRM0335C1H5R5BD01D | GRM1555C1H5R5BA01D |
| | ±0.25pF(C) | GRM0225C1C5R5CD05L | GRM0335C1H5R5CD01D | GRM1555C1H5R5CA01D |
| | ±0.5pF(D) | GRM0225C1C5R5DD05L | GRM0335C1H5R5DD01D | GRM1555C1H5R5DA01D |
| 5.6pF(5R6) | ±0.05pF(W) | GRM0225C1C5R6WD05L | GRM0335C1H5R6WD01D | GRM1555C1H5R6WA01D |
| | ±0.1pF(B) | GRM0225C1C5R6BD05L | GRM0335C1H5R6BD01D | GRM1555C1H5R6BA01D |
| | ±0.25pF(C) | GRM0225C1C5R6CD05L | GRM0335C1H5R6CD01D | GRM1555C1H5R6CA01D |
| | ±0.5pF(D) | GRM0225C1C5R6DD05L | GRM0335C1H5R6DD01D | GRM1555C1H5R6DA01D |
| 5.7pF(5R7) | ±0.05pF(W) | GRM0225C1C5R7WD05L | GRM0335C1H5R7WD01D | GRM1555C1H5R7WA01D |
| | ±0.1pF(B) | GRM0225C1C5R7BD05L | GRM0335C1H5R7BD01D | GRM1555C1H5R7BA01D |
| | ±0.25pF(C) | GRM0225C1C5R7CD05L | GRM0335C1H5R7CD01D | GRM1555C1H5R7CA01D |
| | ±0.5pF(D) | GRM0225C1C5R7DD05L | GRM0335C1H5R7DD01D | GRM1555C1H5R7DA01D |
| 5.8pF(5R8) | ±0.05pF(W) | GRM0225C1C5R8WD05L | GRM0335C1H5R8WD01D | GRM1555C1H5R8WA01D |
| | ±0.1pF(B) | GRM0225C1C5R8BD05L | GRM0335C1H5R8BD01D | GRM1555C1H5R8BA01D |
| | ±0.25pF(C) | GRM0225C1C5R8CD05L | GRM0335C1H5R8CD01D | GRM1555C1H5R8CA01D |
| | ±0.5pF(D) | GRM0225C1C5R8DD05L | GRM0335C1H5R8DD01D | GRM1555C1H5R8DA01D |
| 5.9pF(5R9) | ±0.05pF(W) | GRM0225C1C5R9WD05L | GRM0335C1H5R9WD01D | GRM1555C1H5R9WA01D |
| | ±0.1pF(B) | GRM0225C1C5R9BD05L | GRM0335C1H5R9BD01D | GRM1555C1H5R9BA01D |
| | ±0.25pF(C) | GRM0225C1C5R9CD05L | GRM0335C1H5R9CD01D | GRM1555C1H5R9CA01D |
| | ±0.5pF(D) | GRM0225C1C5R9DD05L | GRM0335C1H5R9DD01D | GRM1555C1H5R9DA01D |
| 6.0pF(6R0) | ±0.05pF(W) | GRM0225C1C6R0WD05L | GRM0335C1H6R0WD01D | GRM1555C1H6R0WA01D |
| | ±0.1pF(B) | GRM0225C1C6R0BD05L | GRM0335C1H6R0BD01D | GRM1555C1H6R0BA01D |
| | ±0.25pF(C) | GRM0225C1C6R0CD05L | GRM0335C1H6R0CD01D | GRM1555C1H6R0CA01D |
| | ±0.5pF(D) | GRM0225C1C6R0DD05L | GRM0335C1H6R0DD01D | GRM1555C1H6R0DA01D |
| 6.1pF(6R1) | ±0.05pF(W) | GRM0225C1C6R1WD05L | GRM0335C1H6R1WD01D | GRM1555C1H6R1WA01D |
| | ±0.1pF(B) | GRM0225C1C6R1BD05L | GRM0335C1H6R1BD01D | GRM1555C1H6R1BA01D |
| | ±0.25pF(C) | GRM0225C1C6R1CD05L | GRM0335C1H6R1CD01D | GRM1555C1H6R1CA01D |
| | ±0.5pF(D) | GRM0225C1C6R1DD05L | GRM0335C1H6R1DD01D | GRM1555C1H6R1DA01D |
| 6.2pF(6R2) | ±0.05pF(W) | GRM0225C1C6R2WD05L | GRM0335C1H6R2WD01D | GRM1555C1H6R2WA01D |
| | ±0.1pF(B) | GRM0225C1C6R2BD05L | GRM0335C1H6R2BD01D | GRM1555C1H6R2BA01D |
| | ±0.25pF(C) | GRM0225C1C6R2CD05L | GRM0335C1H6R2CD01D | GRM1555C1H6R2CA01D |
| | ±0.5pF(D) | GRM0225C1C6R2DD05L | GRM0335C1H6R2DD01D | GRM1555C1H6R2DA01D |
| 6.3pF(6R3) | ±0.05pF(W) | GRM0225C1C6R3WD05L | GRM0335C1H6R3WD01D | GRM1555C1H6R3WA01D |
| | ±0.1pF(B) | GRM0225C1C6R3BD05L | GRM0335C1H6R3BD01D | GRM1555C1H6R3BA01D |
| | ±0.25pF(C) | GRM0225C1C6R3CD05L | GRM0335C1H6R3CD01D | GRM1555C1H6R3CA01D |
| | ±0.5pF(D) | GRM0225C1C6R3DD05L | GRM0335C1H6R3DD01D | GRM1555C1H6R3DA01D |

The part number code is shown in () and Unit is shown in []. < >: EIA [inch] Code

(Part Number) **GR** **M** **02** **2** **5C** **1C** **5R2** **W** **D05** **L** ①Product ID ②Series ③Dimensions (LxW) ④Dimension (T)
 ⑤Temperature Characteristics ⑥Rated Voltage ⑦Capacitance
 ⑧Capacitance Tolerance ⑨Individual Specification Code ⑩Packaging*

Packaging Code in Part Number shows STD 180mm Reel Taping.

*GRM022: D is applicable.

Temperature Compensating Type C0G(5C) Characteristics

| LxW [mm] | | 0.4x0.2(02)<01005> | 0.6x0.3(03)<0201> | 1.0x0.5(15)<0402> |
|-------------------|------------|--------------------|--------------------|--------------------|
| Rated Volt. [Vdc] | | 16(1C) | 50(1H) | 50(1H) |
| Capacitance | Tolerance | Part Number | | |
| 6.4pF(6R4) | ±0.05pF(W) | GRM0225C1C6R4WD05L | GRM0335C1H6R4WD01D | GRM1555C1H6R4WA01D |
| | ±0.1pF(B) | GRM0225C1C6R4BD05L | GRM0335C1H6R4BD01D | GRM1555C1H6R4BA01D |
| | ±0.25pF(C) | GRM0225C1C6R4CD05L | GRM0335C1H6R4CD01D | GRM1555C1H6R4CA01D |
| | ±0.5pF(D) | GRM0225C1C6R4DD05L | GRM0335C1H6R4DD01D | GRM1555C1H6R4DA01D |
| 6.5pF(6R5) | ±0.05pF(W) | GRM0225C1C6R5WD05L | GRM0335C1H6R5WD01D | GRM1555C1H6R5WA01D |
| | ±0.1pF(B) | GRM0225C1C6R5BD05L | GRM0335C1H6R5BD01D | GRM1555C1H6R5BA01D |
| | ±0.25pF(C) | GRM0225C1C6R5CD05L | GRM0335C1H6R5CD01D | GRM1555C1H6R5CA01D |
| | ±0.5pF(D) | GRM0225C1C6R5DD05L | GRM0335C1H6R5DD01D | GRM1555C1H6R5DA01D |
| 6.6pF(6R6) | ±0.05pF(W) | GRM0225C1C6R6WD05L | GRM0335C1H6R6WD01D | GRM1555C1H6R6WA01D |
| | ±0.1pF(B) | GRM0225C1C6R6BD05L | GRM0335C1H6R6BD01D | GRM1555C1H6R6BA01D |
| | ±0.25pF(C) | GRM0225C1C6R6CD05L | GRM0335C1H6R6CD01D | GRM1555C1H6R6CA01D |
| | ±0.5pF(D) | GRM0225C1C6R6DD05L | GRM0335C1H6R6DD01D | GRM1555C1H6R6DA01D |
| 6.7pF(6R7) | ±0.05pF(W) | GRM0225C1C6R7WD05L | GRM0335C1H6R7WD01D | GRM1555C1H6R7WA01D |
| | ±0.1pF(B) | GRM0225C1C6R7BD05L | GRM0335C1H6R7BD01D | GRM1555C1H6R7BA01D |
| | ±0.25pF(C) | GRM0225C1C6R7CD05L | GRM0335C1H6R7CD01D | GRM1555C1H6R7CA01D |
| | ±0.5pF(D) | GRM0225C1C6R7DD05L | GRM0335C1H6R7DD01D | GRM1555C1H6R7DA01D |
| 6.8pF(6R8) | ±0.05pF(W) | GRM0225C1C6R8WD05L | GRM0335C1H6R8WD01D | GRM1555C1H6R8WA01D |
| | ±0.1pF(B) | GRM0225C1C6R8BD05L | GRM0335C1H6R8BD01D | GRM1555C1H6R8BA01D |
| | ±0.25pF(C) | GRM0225C1C6R8CD05L | GRM0335C1H6R8CD01D | GRM1555C1H6R8CA01D |
| | ±0.5pF(D) | GRM0225C1C6R8DD05L | GRM0335C1H6R8DD01D | GRM1555C1H6R8DA01D |
| 6.9pF(6R9) | ±0.05pF(W) | GRM0225C1C6R9WD05L | GRM0335C1H6R9WD01D | GRM1555C1H6R9WA01D |
| | ±0.1pF(B) | GRM0225C1C6R9BD05L | GRM0335C1H6R9BD01D | GRM1555C1H6R9BA01D |
| | ±0.25pF(C) | GRM0225C1C6R9CD05L | GRM0335C1H6R9CD01D | GRM1555C1H6R9CA01D |
| | ±0.5pF(D) | GRM0225C1C6R9DD05L | GRM0335C1H6R9DD01D | GRM1555C1H6R9DA01D |
| 7.0pF(7R0) | ±0.05pF(W) | GRM0225C1C7R0WD05L | GRM0335C1H7R0WD01D | GRM1555C1H7R0WA01D |
| | ±0.1pF(B) | GRM0225C1C7R0BD05L | GRM0335C1H7R0BD01D | GRM1555C1H7R0BA01D |
| | ±0.25pF(C) | GRM0225C1C7R0CD05L | GRM0335C1H7R0CD01D | GRM1555C1H7R0CA01D |
| | ±0.5pF(D) | GRM0225C1C7R0DD05L | GRM0335C1H7R0DD01D | GRM1555C1H7R0DA01D |
| 7.1pF(7R1) | ±0.05pF(W) | GRM0225C1C7R1WD05L | GRM0335C1H7R1WD01D | GRM1555C1H7R1WA01D |
| | ±0.1pF(B) | GRM0225C1C7R1BD05L | GRM0335C1H7R1BD01D | GRM1555C1H7R1BA01D |
| | ±0.25pF(C) | GRM0225C1C7R1CD05L | GRM0335C1H7R1CD01D | GRM1555C1H7R1CA01D |
| | ±0.5pF(D) | GRM0225C1C7R1DD05L | GRM0335C1H7R1DD01D | GRM1555C1H7R1DA01D |
| 7.2pF(7R2) | ±0.05pF(W) | GRM0225C1C7R2WD05L | GRM0335C1H7R2WD01D | GRM1555C1H7R2WA01D |
| | ±0.1pF(B) | GRM0225C1C7R2BD05L | GRM0335C1H7R2BD01D | GRM1555C1H7R2BA01D |
| | ±0.25pF(C) | GRM0225C1C7R2CD05L | GRM0335C1H7R2CD01D | GRM1555C1H7R2CA01D |
| | ±0.5pF(D) | GRM0225C1C7R2DD05L | GRM0335C1H7R2DD01D | GRM1555C1H7R2DA01D |
| 7.3pF(7R3) | ±0.05pF(W) | GRM0225C1C7R3WD05L | GRM0335C1H7R3WD01D | GRM1555C1H7R3WA01D |
| | ±0.1pF(B) | GRM0225C1C7R3BD05L | GRM0335C1H7R3BD01D | GRM1555C1H7R3BA01D |
| | ±0.25pF(C) | GRM0225C1C7R3CD05L | GRM0335C1H7R3CD01D | GRM1555C1H7R3CA01D |
| | ±0.5pF(D) | GRM0225C1C7R3DD05L | GRM0335C1H7R3DD01D | GRM1555C1H7R3DA01D |
| 7.4pF(7R4) | ±0.05pF(W) | GRM0225C1C7R4WD05L | GRM0335C1H7R4WD01D | GRM1555C1H7R4WA01D |
| | ±0.1pF(B) | GRM0225C1C7R4BD05L | GRM0335C1H7R4BD01D | GRM1555C1H7R4BA01D |
| | ±0.25pF(C) | GRM0225C1C7R4CD05L | GRM0335C1H7R4CD01D | GRM1555C1H7R4CA01D |
| | ±0.5pF(D) | GRM0225C1C7R4DD05L | GRM0335C1H7R4DD01D | GRM1555C1H7R4DA01D |
| 7.5pF(7R5) | ±0.05pF(W) | GRM0225C1C7R5WD05L | GRM0335C1H7R5WD01D | GRM1555C1H7R5WA01D |
| | ±0.1pF(B) | GRM0225C1C7R5BD05L | GRM0335C1H7R5BD01D | GRM1555C1H7R5BA01D |
| | ±0.25pF(C) | GRM0225C1C7R5CD05L | GRM0335C1H7R5CD01D | GRM1555C1H7R5CA01D |
| | ±0.5pF(D) | GRM0225C1C7R5DD05L | GRM0335C1H7R5DD01D | GRM1555C1H7R5DA01D |

The part number code is shown in () and Unit is shown in []. < >: EIA [inch] Code

For General GRM Series

Array GNM Series

Low ESL LL□ Series

High-Q GJM Series

High Frequency GQM Series

Monolithic Microchip GMA Series

For Bonding GMD Series

Product Information

Temperature Compensating Type C0G(5C) Characteristics

| LxW [mm] | | 0.4x0.2(02)<01005> | 0.6x0.3(03)<0201> | 1.0x0.5(15)<0402> |
|-------------------|------------|--------------------|--------------------|--------------------|
| Rated Volt. [Vdc] | | 16(1C) | 50(1H) | 50(1H) |
| Capacitance | Tolerance | Part Number | | |
| 7.6pF(7R6) | ±0.05pF(W) | GRM0225C1C7R6WD05L | GRM0335C1H7R6WD01D | GRM1555C1H7R6WA01D |
| | ±0.1pF(B) | GRM0225C1C7R6BD05L | GRM0335C1H7R6BD01D | GRM1555C1H7R6BA01D |
| | ±0.25pF(C) | GRM0225C1C7R6CD05L | GRM0335C1H7R6CD01D | GRM1555C1H7R6CA01D |
| | ±0.5pF(D) | GRM0225C1C7R6DD05L | GRM0335C1H7R6DD01D | GRM1555C1H7R6DA01D |
| 7.7pF(7R7) | ±0.05pF(W) | GRM0225C1C7R7WD05L | GRM0335C1H7R7WD01D | GRM1555C1H7R7WA01D |
| | ±0.1pF(B) | GRM0225C1C7R7BD05L | GRM0335C1H7R7BD01D | GRM1555C1H7R7BA01D |
| | ±0.25pF(C) | GRM0225C1C7R7CD05L | GRM0335C1H7R7CD01D | GRM1555C1H7R7CA01D |
| | ±0.5pF(D) | GRM0225C1C7R7DD05L | GRM0335C1H7R7DD01D | GRM1555C1H7R7DA01D |
| 7.8pF(7R8) | ±0.05pF(W) | GRM0225C1C7R8WD05L | GRM0335C1H7R8WD01D | GRM1555C1H7R8WA01D |
| | ±0.1pF(B) | GRM0225C1C7R8BD05L | GRM0335C1H7R8BD01D | GRM1555C1H7R8BA01D |
| | ±0.25pF(C) | GRM0225C1C7R8CD05L | GRM0335C1H7R8CD01D | GRM1555C1H7R8CA01D |
| | ±0.5pF(D) | GRM0225C1C7R8DD05L | GRM0335C1H7R8DD01D | GRM1555C1H7R8DA01D |
| 7.9pF(7R9) | ±0.05pF(W) | GRM0225C1C7R9WD05L | GRM0335C1H7R9WD01D | GRM1555C1H7R9WA01D |
| | ±0.1pF(B) | GRM0225C1C7R9BD05L | GRM0335C1H7R9BD01D | GRM1555C1H7R9BA01D |
| | ±0.25pF(C) | GRM0225C1C7R9CD05L | GRM0335C1H7R9CD01D | GRM1555C1H7R9CA01D |
| | ±0.5pF(D) | GRM0225C1C7R9DD05L | GRM0335C1H7R9DD01D | GRM1555C1H7R9DA01D |
| 8.0pF(8R0) | ±0.05pF(W) | GRM0225C1C8R0WD05L | GRM0335C1H8R0WD01D | GRM1555C1H8R0WA01D |
| | ±0.1pF(B) | GRM0225C1C8R0BD05L | GRM0335C1H8R0BD01D | GRM1555C1H8R0BA01D |
| | ±0.25pF(C) | GRM0225C1C8R0CD05L | GRM0335C1H8R0CD01D | GRM1555C1H8R0CA01D |
| | ±0.5pF(D) | GRM0225C1C8R0DD05L | GRM0335C1H8R0DD01D | GRM1555C1H8R0DA01D |
| 8.1pF(8R1) | ±0.05pF(W) | GRM0225C1C8R1WD05L | GRM0335C1H8R1WD01D | GRM1555C1H8R1WA01D |
| | ±0.1pF(B) | GRM0225C1C8R1BD05L | GRM0335C1H8R1BD01D | GRM1555C1H8R1BA01D |
| | ±0.25pF(C) | GRM0225C1C8R1CD05L | GRM0335C1H8R1CD01D | GRM1555C1H8R1CA01D |
| | ±0.5pF(D) | GRM0225C1C8R1DD05L | GRM0335C1H8R1DD01D | GRM1555C1H8R1DA01D |
| 8.2pF(8R2) | ±0.05pF(W) | GRM0225C1C8R2WD05L | GRM0335C1H8R2WD01D | GRM1555C1H8R2WA01D |
| | ±0.1pF(B) | GRM0225C1C8R2BD05L | GRM0335C1H8R2BD01D | GRM1555C1H8R2BA01D |
| | ±0.25pF(C) | GRM0225C1C8R2CD05L | GRM0335C1H8R2CD01D | GRM1555C1H8R2CA01D |
| | ±0.5pF(D) | GRM0225C1C8R2DD05L | GRM0335C1H8R2DD01D | GRM1555C1H8R2DA01D |
| 8.3pF(8R3) | ±0.05pF(W) | GRM0225C1C8R3WD05L | GRM0335C1H8R3WD01D | GRM1555C1H8R3WA01D |
| | ±0.1pF(B) | GRM0225C1C8R3BD05L | GRM0335C1H8R3BD01D | GRM1555C1H8R3BA01D |
| | ±0.25pF(C) | GRM0225C1C8R3CD05L | GRM0335C1H8R3CD01D | GRM1555C1H8R3CA01D |
| | ±0.5pF(D) | GRM0225C1C8R3DD05L | GRM0335C1H8R3DD01D | GRM1555C1H8R3DA01D |
| 8.4pF(8R4) | ±0.05pF(W) | GRM0225C1C8R4WD05L | GRM0335C1H8R4WD01D | GRM1555C1H8R4WA01D |
| | ±0.1pF(B) | GRM0225C1C8R4BD05L | GRM0335C1H8R4BD01D | GRM1555C1H8R4BA01D |
| | ±0.25pF(C) | GRM0225C1C8R4CD05L | GRM0335C1H8R4CD01D | GRM1555C1H8R4CA01D |
| | ±0.5pF(D) | GRM0225C1C8R4DD05L | GRM0335C1H8R4DD01D | GRM1555C1H8R4DA01D |
| 8.5pF(8R5) | ±0.05pF(W) | GRM0225C1C8R5WD05L | GRM0335C1H8R5WD01D | GRM1555C1H8R5WA01D |
| | ±0.1pF(B) | GRM0225C1C8R5BD05L | GRM0335C1H8R5BD01D | GRM1555C1H8R5BA01D |
| | ±0.25pF(C) | GRM0225C1C8R5CD05L | GRM0335C1H8R5CD01D | GRM1555C1H8R5CA01D |
| | ±0.5pF(D) | GRM0225C1C8R5DD05L | GRM0335C1H8R5DD01D | GRM1555C1H8R5DA01D |
| 8.6pF(8R6) | ±0.05pF(W) | GRM0225C1C8R6WD05L | GRM0335C1H8R6WD01D | GRM1555C1H8R6WA01D |
| | ±0.1pF(B) | GRM0225C1C8R6BD05L | GRM0335C1H8R6BD01D | GRM1555C1H8R6BA01D |
| | ±0.25pF(C) | GRM0225C1C8R6CD05L | GRM0335C1H8R6CD01D | GRM1555C1H8R6CA01D |
| | ±0.5pF(D) | GRM0225C1C8R6DD05L | GRM0335C1H8R6DD01D | GRM1555C1H8R6DA01D |
| 8.7pF(8R7) | ±0.05pF(W) | GRM0225C1C8R7WD05L | GRM0335C1H8R7WD01D | GRM1555C1H8R7WA01D |
| | ±0.1pF(B) | GRM0225C1C8R7BD05L | GRM0335C1H8R7BD01D | GRM1555C1H8R7BA01D |
| | ±0.25pF(C) | GRM0225C1C8R7CD05L | GRM0335C1H8R7CD01D | GRM1555C1H8R7CA01D |
| | ±0.5pF(D) | GRM0225C1C8R7DD05L | GRM0335C1H8R7DD01D | GRM1555C1H8R7DA01D |

The part number code is shown in () and Unit is shown in []. < >: EIA [inch] Code

(Part Number) GR M 02 2 5C 1C 7R6 W D05 L 1 2 3 4 5 6 7 8 9 10

Packaging Code in Part Number shows STD 180mm Reel Taping.

*GRM022: D is applicable.

Temperature Compensating Type C0G(5C) Characteristics

| LxW [mm] | | 0.4x0.2(02)<01005> | 0.6x0.3(03)<0201> | 1.0x0.5(15)<0402> |
|-------------------|------------|--------------------|--------------------|--------------------|
| Rated Volt. [Vdc] | | 16(1C) | 50(1H) | 50(1H) |
| Capacitance | Tolerance | Part Number | | |
| 8.8pF(8R8) | ±0.05pF(W) | GRM0225C1C8R8WD05L | GRM0335C1H8R8WD01D | GRM1555C1H8R8WA01D |
| | ±0.1pF(B) | GRM0225C1C8R8BD05L | GRM0335C1H8R8BD01D | GRM1555C1H8R8BA01D |
| | ±0.25pF(C) | GRM0225C1C8R8CD05L | GRM0335C1H8R8CD01D | GRM1555C1H8R8CA01D |
| | ±0.5pF(D) | GRM0225C1C8R8DD05L | GRM0335C1H8R8DD01D | GRM1555C1H8R8DA01D |
| 8.9pF(8R9) | ±0.05pF(W) | GRM0225C1C8R9WD05L | GRM0335C1H8R9WD01D | GRM1555C1H8R9WA01D |
| | ±0.1pF(B) | GRM0225C1C8R9BD05L | GRM0335C1H8R9BD01D | GRM1555C1H8R9BA01D |
| | ±0.25pF(C) | GRM0225C1C8R9CD05L | GRM0335C1H8R9CD01D | GRM1555C1H8R9CA01D |
| | ±0.5pF(D) | GRM0225C1C8R9DD05L | GRM0335C1H8R9DD01D | GRM1555C1H8R9DA01D |
| 9.0pF(9R0) | ±0.05pF(W) | GRM0225C1C9R0WD05L | GRM0335C1H9R0WD01D | GRM1555C1H9R0WA01D |
| | ±0.1pF(B) | GRM0225C1C9R0BD05L | GRM0335C1H9R0BD01D | GRM1555C1H9R0BA01D |
| | ±0.25pF(C) | GRM0225C1C9R0CD05L | GRM0335C1H9R0CD01D | GRM1555C1H9R0CA01D |
| | ±0.5pF(D) | GRM0225C1C9R0DD05L | GRM0335C1H9R0DD01D | GRM1555C1H9R0DA01D |
| 9.1pF(9R1) | ±0.05pF(W) | GRM0225C1C9R1WD05L | GRM0335C1H9R1WD01D | GRM1555C1H9R1WA01D |
| | ±0.1pF(B) | GRM0225C1C9R1BD05L | GRM0335C1H9R1BD01D | GRM1555C1H9R1BA01D |
| | ±0.25pF(C) | GRM0225C1C9R1CD05L | GRM0335C1H9R1CD01D | GRM1555C1H9R1CA01D |
| | ±0.5pF(D) | GRM0225C1C9R1DD05L | GRM0335C1H9R1DD01D | GRM1555C1H9R1DA01D |
| 9.2pF(9R2) | ±0.05pF(W) | GRM0225C1C9R2WD05L | GRM0335C1H9R2WD01D | GRM1555C1H9R2WA01D |
| | ±0.1pF(B) | GRM0225C1C9R2BD05L | GRM0335C1H9R2BD01D | GRM1555C1H9R2BA01D |
| | ±0.25pF(C) | GRM0225C1C9R2CD05L | GRM0335C1H9R2CD01D | GRM1555C1H9R2CA01D |
| | ±0.5pF(D) | GRM0225C1C9R2DD05L | GRM0335C1H9R2DD01D | GRM1555C1H9R2DA01D |
| 9.3pF(9R3) | ±0.05pF(W) | GRM0225C1C9R3WD05L | GRM0335C1H9R3WD01D | GRM1555C1H9R3WA01D |
| | ±0.1pF(B) | GRM0225C1C9R3BD05L | GRM0335C1H9R3BD01D | GRM1555C1H9R3BA01D |
| | ±0.25pF(C) | GRM0225C1C9R3CD05L | GRM0335C1H9R3CD01D | GRM1555C1H9R3CA01D |
| | ±0.5pF(D) | GRM0225C1C9R3DD05L | GRM0335C1H9R3DD01D | GRM1555C1H9R3DA01D |
| 9.4pF(9R4) | ±0.05pF(W) | GRM0225C1C9R4WD05L | GRM0335C1H9R4WD01D | GRM1555C1H9R4WA01D |
| | ±0.1pF(B) | GRM0225C1C9R4BD05L | GRM0335C1H9R4BD01D | GRM1555C1H9R4BA01D |
| | ±0.25pF(C) | GRM0225C1C9R4CD05L | GRM0335C1H9R4CD01D | GRM1555C1H9R4CA01D |
| | ±0.5pF(D) | GRM0225C1C9R4DD05L | GRM0335C1H9R4DD01D | GRM1555C1H9R4DA01D |
| 9.5pF(9R5) | ±0.05pF(W) | GRM0225C1C9R5WD05L | GRM0335C1H9R5WD01D | GRM1555C1H9R5WA01D |
| | ±0.1pF(B) | GRM0225C1C9R5BD05L | GRM0335C1H9R5BD01D | GRM1555C1H9R5BA01D |
| | ±0.25pF(C) | GRM0225C1C9R5CD05L | GRM0335C1H9R5CD01D | GRM1555C1H9R5CA01D |
| | ±0.5pF(D) | GRM0225C1C9R5DD05L | GRM0335C1H9R5DD01D | GRM1555C1H9R5DA01D |
| 9.6pF(9R6) | ±0.05pF(W) | GRM0225C1C9R6WD05L | GRM0335C1H9R6WD01D | GRM1555C1H9R6WA01D |
| | ±0.1pF(B) | GRM0225C1C9R6BD05L | GRM0335C1H9R6BD01D | GRM1555C1H9R6BA01D |
| | ±0.25pF(C) | GRM0225C1C9R6CD05L | GRM0335C1H9R6CD01D | GRM1555C1H9R6CA01D |
| | ±0.5pF(D) | GRM0225C1C9R6DD05L | GRM0335C1H9R6DD01D | GRM1555C1H9R6DA01D |
| 9.7pF(9R7) | ±0.05pF(W) | GRM0225C1C9R7WD05L | GRM0335C1H9R7WD01D | GRM1555C1H9R7WA01D |
| | ±0.1pF(B) | GRM0225C1C9R7BD05L | GRM0335C1H9R7BD01D | GRM1555C1H9R7BA01D |
| | ±0.25pF(C) | GRM0225C1C9R7CD05L | GRM0335C1H9R7CD01D | GRM1555C1H9R7CA01D |
| | ±0.5pF(D) | GRM0225C1C9R7DD05L | GRM0335C1H9R7DD01D | GRM1555C1H9R7DA01D |
| 9.8pF(9R8) | ±0.05pF(W) | GRM0225C1C9R8WD05L | GRM0335C1H9R8WD01D | GRM1555C1H9R8WA01D |
| | ±0.1pF(B) | GRM0225C1C9R8BD05L | GRM0335C1H9R8BD01D | GRM1555C1H9R8BA01D |
| | ±0.25pF(C) | GRM0225C1C9R8CD05L | GRM0335C1H9R8CD01D | GRM1555C1H9R8CA01D |
| | ±0.5pF(D) | GRM0225C1C9R8DD05L | GRM0335C1H9R8DD01D | GRM1555C1H9R8DA01D |
| 9.9pF(9R9) | ±0.05pF(W) | GRM0225C1C9R9WD05L | GRM0335C1H9R9WD01D | GRM1555C1H9R9WA01D |
| | ±0.1pF(B) | GRM0225C1C9R9BD05L | GRM0335C1H9R9BD01D | GRM1555C1H9R9BA01D |
| | ±0.25pF(C) | GRM0225C1C9R9CD05L | GRM0335C1H9R9CD01D | GRM1555C1H9R9CA01D |
| | ±0.5pF(D) | GRM0225C1C9R9DD05L | GRM0335C1H9R9DD01D | GRM1555C1H9R9DA01D |

The part number code is shown in () and Unit is shown in []. < >: EIA [inch] Code

For General GRM Series

Array GNM Series

Low ESL LL□ Series

High-Q GJM Series

High Frequency GQM Series

Monolithic Microchip GMA Series

For Bonding GMD Series

Product Information

Temperature Compensating Type C0G(5C) Characteristics

| LxW [mm] | | 0.4x0.2(02)<01005> | | | 0.6x0.3(03)<0201> |
|-------------------|-----------|--------------------|--------------------|--------------------|--------------------|
| Rated Volt. [Vdc] | | 16(1C) | 10(1A) | 6.3(0J) | 50(1H) |
| Capacitance | Tolerance | Part Number | | | |
| 10pF(100) | ±2%(G) | GRM0225C1C100GD05L | | | GRM0335C1H100GD01D |
| | ±5%(J) | GRM0225C1C100JD05L | | | GRM0335C1H100JD01D |
| 12pF(120) | ±2%(G) | GRM0225C1C120GD05L | | | GRM0335C1H120GD01D |
| | ±5%(J) | GRM0225C1C120JD05L | | | GRM0335C1H120JD01D |
| 15pF(150) | ±2%(G) | GRM0225C1C150GD05L | | | GRM0335C1H150GD01D |
| | ±5%(J) | GRM0225C1C150JD05L | | | GRM0335C1H150JD01D |
| 18pF(180) | ±2%(G) | GRM0225C1C180GD05L | | | GRM0335C1H180GD01D |
| | ±5%(J) | GRM0225C1C180JD05L | | | GRM0335C1H180JD01D |
| 22pF(220) | ±2%(G) | GRM0225C1C220GD05L | | | GRM0335C1H220GD01D |
| | ±5%(J) | GRM0225C1C220JD05L | | | GRM0335C1H220JD01D |
| 27pF(270) | ±2%(G) | GRM0225C1C270GD05L | | | GRM0335C1H270GD01D |
| | ±5%(J) | GRM0225C1C270JD05L | | | GRM0335C1H270JD01D |
| 33pF(330) | ±2%(G) | GRM0225C1C330GD05L | | | GRM0335C1H330GD01D |
| | ±5%(J) | GRM0225C1C330JD05L | | | GRM0335C1H330JD01D |
| 39pF(390) | ±2%(G) | GRM0225C1C390GD05L | | | GRM0335C1H390GD01D |
| | ±5%(J) | GRM0225C1C390JD05L | | | GRM0335C1H390JD01D |
| 47pF(470) | ±2%(G) | GRM0225C1C470GD05L | | | GRM0335C1H470GD01D |
| | ±5%(J) | GRM0225C1C470JD05L | | | GRM0335C1H470JD01D |
| 56pF(560) | ±2%(G) | | GRM0225C1A560GD05L | GRM0225C0J560GD05L | GRM0335C1H560GD01D |
| | ±5%(J) | | GRM0225C1A560JD05L | GRM0225C0J560JD05L | GRM0335C1H560JD01D |
| 68pF(680) | ±2%(G) | | GRM0225C1A680GD05L | GRM0225C0J680GD05L | GRM0335C1H680GD01D |
| | ±5%(J) | | GRM0225C1A680JD05L | GRM0225C0J680JD05L | GRM0335C1H680JD01D |
| 82pF(820) | ±2%(G) | | GRM0225C1A820GD05L | GRM0225C0J820GD05L | GRM0335C1H820GD01D |
| | ±5%(J) | | GRM0225C1A820JD05L | GRM0225C0J820JD05L | GRM0335C1H820JD01D |
| 100pF(101) | ±2%(G) | | GRM0225C1A101GD05L | GRM0225C0J101GD05L | GRM0335C1H101GD01D |
| | ±5%(J) | | GRM0225C1A101JD05L | GRM0225C0J101JD05L | GRM0335C1H101JD01D |

The part number code is shown in () and Unit is shown in []. < >: EIA [inch] Code

For General GRM Series

Array GNM Series

Low ESL LL□ Series

High-Q GJM Series

High Frequency GQM Series

Monolithic Microchip GMA Series

For Bonding GMD Series

Product Information

- (Part Number) **GR** **M** **02** **2** **5C** **1C** **100** **G** **D05** **L**
- ① Product ID
 - ② Series
 - ③ Dimensions (LxW)
 - ④ Dimension (T)
 - ⑤ Temperature Characteristics
 - ⑥ Rated Voltage
 - ⑦ Capacitance
 - ⑧ Capacitance Tolerance
 - ⑨ Individual Specification Code
 - ⑩ Packaging*

Packaging Code in Part Number shows STD 180mm Reel Taping.

*GRM022: D is applicable.

Temperature Compensating Type C0G(5C) Characteristics

| LxW [mm] | | 1.0x0.5(15)<0402> |
|-------------------|-----------|--------------------|
| Rated Volt. [Vdc] | | 50(1H) |
| TC | | C0G(5C) |
| Capacitance | Tolerance | Part Number |
| 10pF(100) | ±2%(G) | GRM1555C1H100GA01D |
| | ±5%(J) | GRM1555C1H100JA01D |
| 12pF(120) | ±2%(G) | GRM1555C1H120GA01D |
| | ±5%(J) | GRM1555C1H120JA01D |
| 15pF(150) | ±2%(G) | GRM1555C1H150GA01D |
| | ±5%(J) | GRM1555C1H150JA01D |
| 18pF(180) | ±2%(G) | GRM1555C1H180GA01D |
| | ±5%(J) | GRM1555C1H180JA01D |
| 22pF(220) | ±2%(G) | GRM1555C1H220GA01D |
| | ±5%(J) | GRM1555C1H220JA01D |
| 27pF(270) | ±2%(G) | GRM1555C1H270GA01D |
| | ±5%(J) | GRM1555C1H270JA01D |
| 33pF(330) | ±2%(G) | GRM1555C1H330GA01D |
| | ±5%(J) | GRM1555C1H330JA01D |
| 39pF(390) | ±2%(G) | GRM1555C1H390GA01D |
| | ±5%(J) | GRM1555C1H390JA01D |
| 47pF(470) | ±2%(G) | GRM1555C1H470GA01D |
| | ±5%(J) | GRM1555C1H470JA01D |
| 56pF(560) | ±2%(G) | GRM1555C1H560GA01D |
| | ±5%(J) | GRM1555C1H560JA01D |
| 68pF(680) | ±2%(G) | GRM1555C1H680GA01D |
| | ±5%(J) | GRM1555C1H680JA01D |
| 82pF(820) | ±2%(G) | GRM1555C1H820GA01D |
| | ±5%(J) | GRM1555C1H820JA01D |
| 100pF(101) | ±2%(G) | GRM1555C1H101GA01D |
| | ±5%(J) | GRM1555C1H101JA01D |
| 120pF(121) | ±2%(G) | GRM1555C1H121GA01D |
| | ±5%(J) | GRM1555C1H121JA01D |
| 150pF(151) | ±2%(G) | GRM1555C1H151GA01D |
| | ±5%(J) | GRM1555C1H151JA01D |
| 180pF(181) | ±2%(G) | GRM1555C1H181GA01D |
| | ±5%(J) | GRM1555C1H181JA01D |
| 220pF(221) | ±2%(G) | GRM1555C1H221GA01D |
| | ±5%(J) | GRM1555C1H221JA01D |
| 270pF(271) | ±2%(G) | GRM1555C1H271GA01D |
| | ±5%(J) | GRM1555C1H271JA01D |
| 330pF(331) | ±2%(G) | GRM1555C1H331GA01D |
| | ±5%(J) | GRM1555C1H331JA01D |
| 390pF(391) | ±2%(G) | GRM1555C1H391GA01D |
| | ±5%(J) | GRM1555C1H391JA01D |
| 470pF(471) | ±2%(G) | GRM1555C1H471GA01D |
| | ±5%(J) | GRM1555C1H471JA01D |
| 560pF(561) | ±2%(G) | GRM1555C1H561GA01D |
| | ±5%(J) | GRM1555C1H561JA01D |
| 680pF(681) | ±2%(G) | GRM1555C1H681GA01D |
| | ±5%(J) | GRM1555C1H681JA01D |
| 820pF(821) | ±2%(G) | GRM1555C1H821GA01D |
| | ±5%(J) | GRM1555C1H821JA01D |
| 1000pF(102) | ±2%(G) | GRM1555C1H102GA01D |
| | ±5%(J) | GRM1555C1H102JA01D |

The part number code is shown in () and Unit is shown in []. < >: EIA [inch] Code

For General GRM Series

Array GNM Series

Low ESL LL□ Series

High-Q GJM Series

High Frequency GQM Series

Monolithic Microchip GMA Series

For Bonding GMD Series

Product Information

Temperature Compensating Type C0G(5C) Characteristics

| LxW [mm] | | 1.6x0.8(18)<0603> | |
|-------------------|-----------|--------------------|--------------------|
| Rated Volt. [Vdc] | | 100(2A) | 50(1H) |
| Capacitance | Tolerance | Part Number | |
| 10pF(100) | ±5%(J) | GRM1885C2A100JA01D | GRM1885C1H100JA01D |
| 12pF(120) | ±5%(J) | GRM1885C2A120JA01D | GRM1885C1H120JA01D |
| 15pF(150) | ±5%(J) | GRM1885C2A150JA01D | GRM1885C1H150JA01D |
| 18pF(180) | ±5%(J) | GRM1885C2A180JA01D | GRM1885C1H180JA01D |
| 22pF(220) | ±5%(J) | GRM1885C2A220JA01D | GRM1885C1H220JA01D |
| 27pF(270) | ±5%(J) | GRM1885C2A270JA01D | GRM1885C1H270JA01D |
| 33pF(330) | ±5%(J) | GRM1885C2A330JA01D | GRM1885C1H330JA01D |
| 39pF(390) | ±5%(J) | GRM1885C2A390JA01D | GRM1885C1H390JA01D |
| 47pF(470) | ±5%(J) | GRM1885C2A470JA01D | GRM1885C1H470JA01D |
| 56pF(560) | ±5%(J) | GRM1885C2A560JA01D | GRM1885C1H560JA01D |
| 68pF(680) | ±5%(J) | GRM1885C2A680JA01D | GRM1885C1H680JA01D |
| 82pF(820) | ±5%(J) | GRM1885C2A820JA01D | GRM1885C1H820JA01D |
| 100pF(101) | ±5%(J) | GRM1885C2A101JA01D | GRM1885C1H101JA01D |
| 120pF(121) | ±5%(J) | GRM1885C2A121JA01D | GRM1885C1H121JA01D |
| 150pF(151) | ±5%(J) | GRM1885C2A151JA01D | GRM1885C1H151JA01D |
| 180pF(181) | ±5%(J) | GRM1885C2A181JA01D | GRM1885C1H181JA01D |
| 220pF(221) | ±5%(J) | GRM1885C2A221JA01D | GRM1885C1H221JA01D |
| 270pF(271) | ±5%(J) | GRM1885C2A271JA01D | GRM1885C1H271JA01D |
| 330pF(331) | ±5%(J) | GRM1885C2A331JA01D | GRM1885C1H331JA01D |
| 390pF(391) | ±5%(J) | GRM1885C2A391JA01D | GRM1885C1H391JA01D |
| 470pF(471) | ±5%(J) | GRM1885C2A471JA01D | GRM1885C1H471JA01D |
| 560pF(561) | ±5%(J) | GRM1885C2A561JA01D | GRM1885C1H561JA01D |
| 680pF(681) | ±5%(J) | GRM1885C2A681JA01D | GRM1885C1H681JA01D |
| 820pF(821) | ±5%(J) | GRM1885C2A821JA01D | GRM1885C1H821JA01D |
| 1000pF(102) | ±5%(J) | GRM1885C2A102JA01D | GRM1885C1H102JA01D |
| 1200pF(122) | ±5%(J) | GRM1885C2A122JA01D | GRM1885C1H122JA01D |
| 1500pF(152) | ±5%(J) | GRM1885C2A152JA01D | GRM1885C1H152JA01D |
| 1800pF(182) | ±5%(J) | | GRM1885C1H182JA01D |
| 2200pF(222) | ±5%(J) | | GRM1885C1H222JA01D |
| 2700pF(272) | ±5%(J) | | GRM1885C1H272JA01D |
| 3300pF(332) | ±5%(J) | | GRM1885C1H332JA01D |
| 3900pF(392) | ±5%(J) | | GRM1885C1H392JA01D |

The part number code is shown in () and Unit is shown in []. < >: EIA [inch] Code

For General GRM Series

Array GNM Series

Low ESL LL□ Series

High-Q GJM Series

High Frequency GQM Series

Monolithic Microchip GMA Series

For Bonding GMD Series

Product Information

- (Part Number) **GR** **M** **18** **8** **5C** **2A** **100** **J** **A01** **D**
- ① Product ID
 - ② Series
 - ③ Dimensions (LxW)
 - ④ Dimension (T)
 - ⑤ Temperature Characteristics
 - ⑥ Rated Voltage
 - ⑦ Capacitance
 - ⑧ Capacitance Tolerance
 - ⑨ Individual Specification Code
 - ⑩ Packaging

Packaging Code in Part Number shows STD 180mm Reel Taping.

Temperature Compensating Type C0G(5C) Characteristics

| LxW [mm] | | 2.0x1.25(21)<0805> | | 3.2x1.6(31)<1206> | |
|-------------------|-----------|--------------------|--------------------|--------------------|--------------------|
| Rated Volt. [Vdc] | | 100(2A) | 50(1H) | 100(2A) | 50(1H) |
| Capacitance | Tolerance | Part Number | | | |
| 100pF(101) | ±5%(J) | GRM2165C2A101JA01D | | | |
| 120pF(121) | ±5%(J) | GRM2165C2A121JA01D | | | |
| 150pF(151) | ±5%(J) | GRM2165C2A151JA01D | | | |
| 180pF(181) | ±5%(J) | GRM2165C2A181JA01D | | | |
| 220pF(221) | ±5%(J) | GRM2165C2A221JA01D | | | |
| 270pF(271) | ±5%(J) | GRM2165C2A271JA01D | | | |
| 330pF(331) | ±5%(J) | GRM2165C2A331JA01D | | | |
| 390pF(391) | ±5%(J) | GRM2165C2A391JA01D | | | |
| 470pF(471) | ±5%(J) | GRM2165C2A471JA01D | | | |
| 560pF(561) | ±5%(J) | GRM2165C2A561JA01D | | | |
| 680pF(681) | ±5%(J) | GRM2165C2A681JA01D | | | |
| 820pF(821) | ±5%(J) | GRM2165C2A821JA01D | | | |
| 1000pF(102) | ±5%(J) | GRM2165C2A102JA01D | | | |
| 1200pF(122) | ±5%(J) | GRM2165C2A122JA01D | GRM2165C1H122JA01D | | |
| 1500pF(152) | ±5%(J) | GRM2165C2A152JA01D | GRM2165C1H152JA01D | | |
| 1800pF(182) | ±5%(J) | GRM2165C2A182JA01D | GRM2165C1H182JA01D | GRM3195C2A182JA01D | |
| 2200pF(222) | ±5%(J) | GRM2165C2A222JA01D | GRM2165C1H222JA01D | GRM3195C2A222JA01D | |
| 2700pF(272) | ±5%(J) | GRM2165C2A272JA01D | GRM2165C1H272JA01D | GRM3195C2A272JA01D | |
| 3300pF(332) | ±5%(J) | GRM2165C2A332JA01D | GRM2165C1H332JA01D | GRM3195C2A332JA01D | |
| 3900pF(392) | ±5%(J) | | GRM2165C1H392JA01D | GRM3195C2A392JA01D | |
| 4700pF(472) | ±5%(J) | | GRM2165C1H472JA01D | GRM3195C2A472JA01D | GRM3195C1H472JA01D |
| 5600pF(562) | ±5%(J) | | GRM2195C1H562JA01D | GRM3195C2A562JA01D | GRM3195C1H562JA01D |
| 6800pF(682) | ±5%(J) | | GRM2195C1H682JA01D | GRM3195C2A682JA01D | GRM3195C1H682JA01D |
| 8200pF(822) | ±5%(J) | | GRM2195C1H822JA01D | GRM3195C2A822JA01D | GRM3195C1H822JA01D |
| 10000pF(103) | ±5%(J) | | GRM2195C1H103JA01D | GRM3195C2A103JA01D | GRM3195C1H103JA01D |
| 12000pF(123) | ±5%(J) | | GRM2195C1H123JA01D | GRM3195C2A123JA01D | GRM3195C1H123JA01D |
| 15000pF(153) | ±5%(J) | | GRM2195C1H153JA01D | GRM3195C2A153JA01D | GRM3195C1H153JA01D |
| 18000pF(183) | ±5%(J) | | GRM21B5C1H183JA01L | GRM3195C2A183JA01D | GRM3195C1H183JA01D |
| 22000pF(223) | ±5%(J) | | GRM21B5C1H223JA01L | GRM3195C2A223JA01D | GRM3195C1H223JA01D |
| 27000pF(273) | ±5%(J) | | | | GRM3195C1H273JA01D |
| 33000pF(333) | ±5%(J) | | | | GRM3195C1H333JA01D |
| 39000pF(393) | ±5%(J) | | | | GRM3195C1H393JA01D |
| 47000pF(473) | ±5%(J) | | | | GRM31M5C1H473JA01L |
| 56000pF(563) | ±5%(J) | | | | GRM31M5C1H563JA01L |
| 68000pF(683) | ±5%(J) | | | | GRM31C5C1H683JA01L |
| 82000pF(823) | ±5%(J) | | | | GRM31C5C1H823JA01L |
| 100000pF(104) | ±5%(J) | | | | GRM31C5C1H104JA01L |

The part number code is shown in () and Unit is shown in []. < >: EIA [inch] Code

For General GRM Series

Array GNM Series

Low ESL LL□ Series

High-Q GJM Series

High Frequency GQM Series

Monolithic Microchip GMA Series

For Bonding GMD Series

Product Information

Temperature Compensating Type C0G(5C) Characteristics-Low Profile

| LxW [mm] | | 1.0x0.5(15)<402> | |
|-------------------|------------|--------------------|--|
| Rated Volt. [Vdc] | | 50(1H) | |
| Capacitance | Tolerance | Part Number | |
| 0.1pF(R10) | ±0.1pF(B) | GRM1535C1HR10BDD5D | |
| 0.2pF(R20) | ±0.1pF(B) | GRM1535C1HR20BDD5D | |
| 0.3pF(R30) | ±0.1pF(B) | GRM1535C1HR30BDD5D | |
| 0.4pF(R40) | ±0.1pF(B) | GRM1535C1HR40BDD5D | |
| 0.5pF(R50) | ±0.1pF(B) | GRM1535C1HR50BDD5D | |
| 0.6pF(R60) | ±0.1pF(B) | GRM1535C1HR60BDD5D | |
| 0.7pF(R70) | ±0.1pF(B) | GRM1535C1HR70BDD5D | |
| 0.8pF(R80) | ±0.1pF(B) | GRM1535C1HR80BDD5D | |
| 0.9pF(R90) | ±0.1pF(B) | GRM1535C1HR90BDD5D | |
| 1.0pF(1R0) | ±0.25pF(C) | GRM1535C1H1R0CDD5D | |
| 1.1pF(1R1) | ±0.25pF(C) | GRM1535C1H1R1CDD5D | |
| 1.2pF(1R2) | ±0.25pF(C) | GRM1535C1H1R2CDD5D | |
| 1.3pF(1R3) | ±0.25pF(C) | GRM1535C1H1R3CDD5D | |
| 1.4pF(1R4) | ±0.25pF(C) | GRM1535C1H1R4CDD5D | |
| 1.5pF(1R5) | ±0.25pF(C) | GRM1535C1H1R5CDD5D | |
| 1.6pF(1R6) | ±0.25pF(C) | GRM1535C1H1R6CDD5D | |
| 1.7pF(1R7) | ±0.25pF(C) | GRM1535C1H1R7CDD5D | |
| 1.8pF(1R8) | ±0.25pF(C) | GRM1535C1H1R8CDD5D | |
| 1.9pF(1R9) | ±0.25pF(C) | GRM1535C1H1R9CDD5D | |
| 2.0pF(2R0) | ±0.25pF(C) | GRM1535C1H2R0CDD5D | |
| 2.1pF(2R1) | ±0.25pF(C) | GRM1535C1H2R1CDD5D | |
| 2.2pF(2R2) | ±0.25pF(C) | GRM1535C1H2R2CDD5D | |
| 2.3pF(2R3) | ±0.25pF(C) | GRM1535C1H2R3CDD5D | |
| 2.4pF(2R4) | ±0.25pF(C) | GRM1535C1H2R4CDD5D | |
| 2.5pF(2R5) | ±0.25pF(C) | GRM1535C1H2R5CDD5D | |
| 2.6pF(2R6) | ±0.25pF(C) | GRM1535C1H2R6CDD5D | |
| 2.7pF(2R7) | ±0.25pF(C) | GRM1535C1H2R7CDD5D | |
| 2.8pF(2R8) | ±0.25pF(C) | GRM1535C1H2R8CDD5D | |
| 2.9pF(2R9) | ±0.25pF(C) | GRM1535C1H2R9CDD5D | |
| 3.0pF(3R0) | ±0.25pF(C) | GRM1535C1H3R0CDD5D | |
| 3.1pF(3R1) | ±0.25pF(C) | GRM1535C1H3R1CDD5D | |
| 3.2pF(3R2) | ±0.25pF(C) | GRM1535C1H3R2CDD5D | |
| 3.3pF(3R3) | ±0.25pF(C) | GRM1535C1H3R3CDD5D | |
| 3.4pF(3R4) | ±0.25pF(C) | GRM1535C1H3R4CDD5D | |
| 3.5pF(3R5) | ±0.25pF(C) | GRM1535C1H3R5CDD5D | |
| 3.6pF(3R6) | ±0.25pF(C) | GRM1535C1H3R6CDD5D | |
| 3.7pF(3R7) | ±0.25pF(C) | GRM1535C1H3R7CDD5D | |
| 3.8pF(3R8) | ±0.25pF(C) | GRM1535C1H3R8CDD5D | |
| 3.9pF(3R9) | ±0.25pF(C) | GRM1535C1H3R9CDD5D | |
| 4.0pF(4R0) | ±0.25pF(C) | GRM1535C1H4R0CDD5D | |
| 4.1pF(4R1) | ±0.25pF(C) | GRM1535C1H4R1CDD5D | |
| 4.2pF(4R2) | ±0.25pF(C) | GRM1535C1H4R2CDD5D | |
| 4.3pF(4R3) | ±0.25pF(C) | GRM1535C1H4R3CDD5D | |
| 4.4pF(4R4) | ±0.25pF(C) | GRM1535C1H4R4CDD5D | |
| 4.5pF(4R5) | ±0.25pF(C) | GRM1535C1H4R5CDD5D | |
| 4.6pF(4R6) | ±0.25pF(C) | GRM1535C1H4R6CDD5D | |
| 4.7pF(4R7) | ±0.25pF(C) | GRM1535C1H4R7CDD5D | |
| 4.8pF(4R8) | ±0.25pF(C) | GRM1535C1H4R8CDD5D | |

| LxW [mm] | | 1.0x0.5(15)<402> | |
|-------------------|------------|--------------------|--|
| Rated Volt. [Vdc] | | 50(1H) | |
| Capacitance | Tolerance | Part Number | |
| 4.9pF(4R9) | ±0.25pF(C) | GRM1535C1H4R9CDD5D | |
| 5.0pF(5R0) | ±0.25pF(C) | GRM1535C1H5R0CDD5D | |
| 5.1pF(5R1) | ±0.5pF(D) | GRM1535C1H5R1DDD5D | |
| 5.2pF(5R2) | ±0.5pF(D) | GRM1535C1H5R2DDD5D | |
| 5.3pF(5R3) | ±0.5pF(D) | GRM1535C1H5R3DDD5D | |
| 5.4pF(5R4) | ±0.5pF(D) | GRM1535C1H5R4DDD5D | |
| 5.5pF(5R5) | ±0.5pF(D) | GRM1535C1H5R5DDD5D | |
| 5.6pF(5R6) | ±0.5pF(D) | GRM1535C1H5R6DDD5D | |
| 5.7pF(5R7) | ±0.5pF(D) | GRM1535C1H5R7DDD5D | |
| 5.8pF(5R8) | ±0.5pF(D) | GRM1535C1H5R8DDD5D | |
| 5.9pF(5R9) | ±0.5pF(D) | GRM1535C1H5R9DDD5D | |
| 6.0pF(6R0) | ±0.5pF(D) | GRM1535C1H6R0DDD5D | |
| 6.1pF(6R1) | ±0.5pF(D) | GRM1535C1H6R1DDD5D | |
| 6.2pF(6R2) | ±0.5pF(D) | GRM1535C1H6R2DDD5D | |
| 6.3pF(6R3) | ±0.5pF(D) | GRM1535C1H6R3DDD5D | |
| 6.4pF(6R4) | ±0.5pF(D) | GRM1535C1H6R4DDD5D | |
| 6.5pF(6R5) | ±0.5pF(D) | GRM1535C1H6R5DDD5D | |
| 6.6pF(6R6) | ±0.5pF(D) | GRM1535C1H6R6DDD5D | |
| 6.7pF(6R7) | ±0.5pF(D) | GRM1535C1H6R7DDD5D | |
| 6.8pF(6R8) | ±0.5pF(D) | GRM1535C1H6R8DDD5D | |
| 6.9pF(6R9) | ±0.5pF(D) | GRM1535C1H6R9DDD5D | |
| 7.0pF(7R0) | ±0.5pF(D) | GRM1535C1H7R0DDD5D | |
| 7.1pF(7R1) | ±0.5pF(D) | GRM1535C1H7R1DDD5D | |
| 7.2pF(7R2) | ±0.5pF(D) | GRM1535C1H7R2DDD5D | |
| 7.3pF(7R3) | ±0.5pF(D) | GRM1535C1H7R3DDD5D | |
| 7.4pF(7R4) | ±0.5pF(D) | GRM1535C1H7R4DDD5D | |
| 7.5pF(7R5) | ±0.5pF(D) | GRM1535C1H7R5DDD5D | |
| 7.6pF(7R6) | ±0.5pF(D) | GRM1535C1H7R6DDD5D | |
| 7.7pF(7R7) | ±0.5pF(D) | GRM1535C1H7R7DDD5D | |
| 7.8pF(7R8) | ±0.5pF(D) | GRM1535C1H7R8DDD5D | |
| 7.9pF(7R9) | ±0.5pF(D) | GRM1535C1H7R9DDD5D | |
| 8.0pF(8R0) | ±0.5pF(D) | GRM1535C1H8R0DDD5D | |
| 8.1pF(8R1) | ±0.5pF(D) | GRM1535C1H8R1DDD5D | |
| 8.2pF(8R2) | ±0.5pF(D) | GRM1535C1H8R2DDD5D | |
| 8.3pF(8R3) | ±0.5pF(D) | GRM1535C1H8R3DDD5D | |
| 8.4pF(8R4) | ±0.5pF(D) | GRM1535C1H8R4DDD5D | |
| 8.5pF(8R5) | ±0.5pF(D) | GRM1535C1H8R5DDD5D | |
| 8.6pF(8R6) | ±0.5pF(D) | GRM1535C1H8R6DDD5D | |
| 8.7pF(8R7) | ±0.5pF(D) | GRM1535C1H8R7DDD5D | |
| 8.8pF(8R8) | ±0.5pF(D) | GRM1535C1H8R8DDD5D | |
| 8.9pF(8R9) | ±0.5pF(D) | GRM1535C1H8R9DDD5D | |
| 9.0pF(9R0) | ±0.5pF(D) | GRM1535C1H9R0DDD5D | |
| 9.1pF(9R1) | ±0.5pF(D) | GRM1535C1H9R1DDD5D | |
| 9.2pF(9R2) | ±0.5pF(D) | GRM1535C1H9R2DDD5D | |
| 9.3pF(9R3) | ±0.5pF(D) | GRM1535C1H9R3DDD5D | |
| 9.4pF(9R4) | ±0.5pF(D) | GRM1535C1H9R4DDD5D | |
| 9.5pF(9R5) | ±0.5pF(D) | GRM1535C1H9R5DDD5D | |
| 9.6pF(9R6) | ±0.5pF(D) | GRM1535C1H9R6DDD5D | |

The part number code is shown in () and Unit is shown in []. < >: EIA [inch] Code

(Part Number) **GR** **M** **15** **3** **5C** **1H** **R10** **B** **DD5** **D** ①Product ID ②Series ③Dimensions (LxW) ④Dimension (T)
 ⑤Temperature Characteristics ⑥Rated Voltage ⑦Capacitance
 ⑧Capacitance Tolerance ⑨Individual Specification Code ⑩Packaging

Packaging Code in Part Number shows STD 180mm Reel Taping.

Temperature Compensating Type C0G(5C) Characteristics-Low Profile

| LxW [mm] | | 1.0x0.5(15)<0402> |
|-------------------|-----------|--------------------|
| Rated Volt. [Vdc] | | 50(1H) |
| Capacitance | Tolerance | Part Number |
| 9.7pF(9R7) | ±0.5pF(D) | GRM1535C1H9R7DDD5D |
| 9.8pF(9R8) | ±0.5pF(D) | GRM1535C1H9R8DDD5D |
| 9.9pF(9R9) | ±0.5pF(D) | GRM1535C1H9R9DDD5D |
| 10pF(100) | ±5%(J) | GRM1535C1H100JDD5D |
| 12pF(120) | ±5%(J) | GRM1535C1H120JDD5D |
| 15pF(150) | ±5%(J) | GRM1535C1H150JDD5D |
| 18pF(180) | ±5%(J) | GRM1535C1H180JDD5D |
| 22pF(220) | ±5%(J) | GRM1535C1H220JDD5D |
| 27pF(270) | ±5%(J) | GRM1535C1H270JDD5D |
| 33pF(330) | ±5%(J) | GRM1535C1H330JDD5D |
| 39pF(390) | ±5%(J) | GRM1535C1H390JDD5D |
| 47pF(470) | ±5%(J) | GRM1535C1H470JDD5D |
| 56pF(560) | ±5%(J) | GRM1535C1H560JDD5D |
| 68pF(680) | ±5%(J) | GRM1535C1H680JDD5D |
| 82pF(820) | ±5%(J) | GRM1535C1H820JDD5D |
| 100pF(101) | ±5%(J) | GRM1535C1H101JDD5D |
| 120pF(121) | ±5%(J) | GRM1535C1H121JDD5D |
| 150pF(151) | ±5%(J) | GRM1535C1H151JDD5D |
| 180pF(181) | ±5%(J) | GRM1535C1H181JDD5D |
| 220pF(221) | ±5%(J) | GRM1535C1H221JDD5D |
| 270pF(271) | ±5%(J) | GRM1535C1H271JDD5D |
| 330pF(331) | ±5%(J) | GRM1535C1H331JDD5D |
| 390pF(391) | ±5%(J) | GRM1535C1H391JDD5D |
| 470pF(471) | ±5%(J) | GRM1535C1H471JDD5D |
| 560pF(561) | ±5%(J) | GRM1535C1H561JDD5D |
| 680pF(681) | ±5%(J) | GRM1535C1H681JDD5D |

The part number code is shown in () and Unit is shown in []. < >: EIA [inch] Code

For General
GRM Series

Array
GMM Series

Low ESL
LL□ Series

High-Q
GJM Series

High Frequency
GQM Series

Monolithic Microchip
GMA Series

For Bonding
GMD Series

Product Information

Temperature Compensating Type C0G(5C) Characteristics-Low Profile

| LxW [mm] | | 2.0x1.25(21)<0805> | | 3.2x1.6(31)<1206> | |
|-------------------|-----------|--------------------|--------------------|--------------------|--------------------|
| Rated Volt. [Vdc] | | 100(2A) | 50(1H) | 100(2A) | 50(1H) |
| Capacitance | Tolerance | Part Number | | | |
| 100pF(101) | ±5%(J) | GRM2165C2A101JA01D | | | |
| 120pF(121) | ±5%(J) | GRM2165C2A121JA01D | | | |
| 150pF(151) | ±5%(J) | GRM2165C2A151JA01D | | | |
| 180pF(181) | ±5%(J) | GRM2165C2A181JA01D | | | |
| 220pF(221) | ±5%(J) | GRM2165C2A221JA01D | | | |
| 270pF(271) | ±5%(J) | GRM2165C2A271JA01D | | | |
| 330pF(331) | ±5%(J) | GRM2165C2A331JA01D | | | |
| 390pF(391) | ±5%(J) | GRM2165C2A391JA01D | | | |
| 470pF(471) | ±5%(J) | GRM2165C2A471JA01D | | | |
| 560pF(561) | ±5%(J) | GRM2165C2A561JA01D | | | |
| 680pF(681) | ±5%(J) | GRM2165C2A681JA01D | | | |
| 820pF(821) | ±5%(J) | GRM2165C2A821JA01D | | | |
| 1000pF(102) | ±5%(J) | GRM2165C2A102JA01D | | | |
| 1200pF(122) | ±5%(J) | GRM2165C2A122JA01D | GRM2165C1H122JA01D | | |
| 1500pF(152) | ±5%(J) | GRM2165C2A152JA01D | GRM2165C1H152JA01D | | |
| 1800pF(182) | ±5%(J) | GRM2165C2A182JA01D | GRM2165C1H182JA01D | GRM3195C2A182JA01D | |
| 2200pF(222) | ±5%(J) | GRM2165C2A222JA01D | GRM2165C1H222JA01D | GRM3195C2A222JA01D | |
| 2700pF(272) | ±5%(J) | GRM2165C2A272JA01D | GRM2165C1H272JA01D | GRM3195C2A272JA01D | |
| 3300pF(332) | ±5%(J) | GRM2165C2A332JA01D | GRM2165C1H332JA01D | GRM3195C2A332JA01D | |
| 3900pF(392) | ±5%(J) | | GRM2165C1H392JA01D | GRM3195C2A392JA01D | |
| 4700pF(472) | ±5%(J) | | GRM2165C1H472JA01D | GRM3195C2A472JA01D | GRM3195C1H472JA01D |
| 5600pF(562) | ±5%(J) | | GRM2195C1H562JA01D | GRM3195C2A562JA01D | GRM3195C1H562JA01D |
| 6800pF(682) | ±5%(J) | | GRM2195C1H682JA01D | GRM3195C2A682JA01D | GRM3195C1H682JA01D |
| 8200pF(822) | ±5%(J) | | GRM2195C1H822JA01D | GRM3195C2A822JA01D | GRM3195C1H822JA01D |
| 10000pF(103) | ±5%(J) | | GRM2195C1H103JA01D | GRM3195C2A103JA01D | GRM3195C1H103JA01D |
| 12000pF(123) | ±5%(J) | | GRM2195C1H123JA01D | | GRM3195C1H123JA01D |
| 15000pF(153) | ±5%(J) | | GRM2195C1H153JA01D | | GRM3195C1H153JA01D |
| 18000pF(183) | ±5%(J) | | | | GRM3195C1H183JA01D |
| 22000pF(223) | ±5%(J) | | | | GRM3195C1H223JA01D |
| 27000pF(273) | ±5%(J) | | | | GRM3195C1H273JA01D |
| 33000pF(333) | ±5%(J) | | | | GRM3195C1H333JA01D |
| 39000pF(393) | ±5%(J) | | | | GRM3195C1H393JA01D |
| 47000pF(473) | ±5%(J) | | | | GRM31M5C1H473JA01L |
| 56000pF(563) | ±5%(J) | | | | GRM31M5C1H563JA01L |

The part number code is shown in () and Unit is shown in []. < >: EIA [inch] Code

(Part Number) GR M 21 6 5C 2A 101 J A01 D

1 Product ID 2 Series 3 Dimensions (LxW) 4 Dimension (T)
5 Temperature Characteristics 6 Rated Voltage 7 Capacitance
8 Capacitance Tolerance 9 Individual Specification Code 10 Packaging

Packaging Code in Part Number shows STD 180mm Reel Taping.

For General GRM Series

Array GNM Series

Low ESL LL□ Series

High-Q GJM Series

High Frequency GQM Series

Monolithic Microchip GMA Series

For Bonding GMD Series

Product Information

Temperature Compensating Type U2J(7U) Characteristics

| LxW [mm] | | 0.6x0.3(03)<0201> | | 1.0x0.5(15)<0402> | |
|-------------------|------------|--------------------|--------------------|--------------------|--------------------|
| Rated Volt. [Vdc] | | 50(1H) | 25(1E) | 50(1H) | 10(1A) |
| Capacitance | Tolerance | Part Number | | | |
| 1.0pF(1R0) | ±0.25pF(C) | GRM0337U1H1R0CD01D | | GRM1557U1H1R0CZ01D | |
| 2.0pF(2R0) | ±0.25pF(C) | GRM0337U1H2R0CD01D | | GRM1557U1H2R0CZ01D | |
| 3.0pF(3R0) | ±0.25pF(C) | GRM0337U1H3R0CD01D | | GRM1557U1H3R0CZ01D | |
| 4.0pF(4R0) | ±0.25pF(C) | GRM0337U1H4R0CD01D | | GRM1557U1H4R0CZ01D | |
| 5.0pF(5R0) | ±0.25pF(C) | GRM0337U1H5R0CD01D | | GRM1557U1H5R0CZ01D | |
| 6.0pF(6R0) | ±0.5pF(D) | GRM0337U1H6R0DD01D | | GRM1557U1H6R0DZ01D | |
| 7.0pF(7R0) | ±0.5pF(D) | GRM0337U1H7R0DD01D | | GRM1557U1H7R0DZ01D | |
| 8.0pF(8R0) | ±0.5pF(D) | GRM0337U1H8R0DD01D | | GRM1557U1H8R0DZ01D | |
| 9.0pF(9R0) | ±0.5pF(D) | GRM0337U1H9R0DD01D | | GRM1557U1H9R0DZ01D | |
| 10pF(100) | ±5%(J) | GRM0337U1H100JD01D | | GRM1557U1H100JZ01D | |
| 12pF(120) | ±5%(J) | GRM0337U1H120JD01D | | GRM1557U1H120JZ01D | |
| 15pF(150) | ±5%(J) | GRM0337U1H150JD01D | | GRM1557U1H150JZ01D | |
| 18pF(180) | ±5%(J) | | GRM0337U1E180JD01D | GRM1557U1H180JZ01D | |
| 22pF(220) | ±5%(J) | | GRM0337U1E220JD01D | GRM1557U1H220JZ01D | |
| 27pF(270) | ±5%(J) | | GRM0337U1E270JD01D | GRM1557U1H270JZ01D | |
| 33pF(330) | ±5%(J) | | GRM0337U1E330JD01D | GRM1557U1H330JZ01D | |
| 39pF(390) | ±5%(J) | | GRM0337U1E390JD01D | GRM1557U1H390JZ01D | |
| 47pF(470) | ±5%(J) | | GRM0337U1E470JD01D | GRM1557U1H470JZ01D | |
| 56pF(560) | ±5%(J) | | GRM0337U1E560JD01D | GRM1557U1H560JZ01D | |
| 68pF(680) | ±5%(J) | | GRM0337U1E680JD01D | GRM1557U1H680JZ01D | |
| 82pF(820) | ±5%(J) | | GRM0337U1E820JD01D | GRM1557U1H820JZ01D | |
| 100pF(101) | ±5%(J) | | GRM0337U1E101JD01D | GRM1557U1H101JZ01D | |
| 120pF(121) | ±5%(J) | | | GRM1557U1H121JZ01D | |
| 150pF(151) | ±5%(J) | | | GRM1557U1H151JZ01D | |
| 180pF(181) | ±5%(J) | | | GRM1557U1H181JZ01D | |
| 1200pF(122) | ±5%(J) | | | | GRM1557U1A122JA01D |
| 1500pF(152) | ±5%(J) | | | | GRM1557U1A152JA01D |
| 1800pF(182) | ±5%(J) | | | | GRM1557U1A182JA01D |
| 2200pF(222) | ±5%(J) | | | | GRM1557U1A222JA01D |
| 2700pF(272) | ±5%(J) | | | | GRM1557U1A272JA01D |
| 3300pF(332) | ±5%(J) | | | | GRM1557U1A332JA01D |
| 3900pF(392) | ±5%(J) | | | | GRM1557U1A392JA01D |
| 4700pF(472) | ±5%(J) | | | | GRM1557U1A472JA01D |

The part number code is shown in () and Unit is shown in []. < >: EIA [inch] Code

For General GRM Series

Array GNM Series

Low ESL LL□ Series

High-Q GJM Series

High Frequency GQM Series

Monolithic Microchip GMA Series

For Bonding GMD Series

Product Information

Temperature Compensating Type U2J(7U) Characteristics

| LxW [mm] | | 1.6x0.8(18)<0603> | |
|-------------------|-----------|--------------------|--------------------|
| Rated Volt. [Vdc] | | 50(1H) | 10(1A) |
| Capacitance | Tolerance | Part Number | |
| 1000pF(102) | ±5%(J) | GRM1887U1H102JA01D | |
| 1200pF(122) | ±5%(J) | GRM1887U1H122JA01D | |
| 1500pF(152) | ±5%(J) | GRM1887U1H152JA01D | |
| 1800pF(182) | ±5%(J) | GRM1887U1H182JA01D | |
| 2200pF(222) | ±5%(J) | GRM1887U1H222JA01D | |
| 2700pF(272) | ±5%(J) | GRM1887U1H272JA01D | |
| 3300pF(332) | ±5%(J) | GRM1887U1H332JA01D | |
| 3900pF(392) | ±5%(J) | GRM1887U1H392JA01D | |
| 4700pF(472) | ±5%(J) | GRM1887U1H472JA01D | |
| 5600pF(562) | ±5%(J) | GRM1887U1H562JA01D | |
| 6800pF(682) | ±5%(J) | GRM1887U1H682JA01D | |
| 8200pF(822) | ±5%(J) | GRM1887U1H822JA01D | |
| 10000pF(103) | ±5%(J) | GRM1887U1H103JA01D | |
| 12000pF(123) | ±5%(J) | | GRM1887U1A123JA01D |
| 15000pF(153) | ±5%(J) | | GRM1887U1A153JA01D |
| 18000pF(183) | ±5%(J) | | GRM1887U1A183JA01D |
| 22000pF(223) | ±5%(J) | | GRM1887U1A223JA01D |

| LxW [mm] | | 2.0x1.25(21)<0805> | | 3.2x1.6(31)<1206> |
|-------------------|-----------|--------------------|--------------------|--------------------|
| Rated Volt. [Vdc] | | 50(1H) | 10(1A) | 50(1H) |
| Capacitance | Tolerance | Part Number | | |
| 10000pF(103) | ±5%(J) | GRM2167U1H103JA01D | | |
| 12000pF(123) | ±5%(J) | GRM2167U1H123JA01D | | |
| 15000pF(153) | ±5%(J) | GRM2167U1H153JA01D | | |
| 18000pF(183) | ±5%(J) | GRM2167U1H183JA01D | | |
| 22000pF(223) | ±5%(J) | GRM2197U1H223JA01D | | |
| 27000pF(273) | ±5%(J) | GRM2197U1H273JA01D | | |
| 33000pF(333) | ±5%(J) | GRM21A7U1H333JA39L | | |
| 39000pF(393) | ±5%(J) | GRM21B7U1H393JA01L | | |
| 47000pF(473) | ±5%(J) | GRM21B7U1H473JA01L | | |
| 56000pF(563) | ±5%(J) | | GRM2197U1A563JA01D | GRM3197U1H563JA01D |
| 68000pF(683) | ±5%(J) | | GRM21B7U1A683JA01L | GRM31M7U1H683JA01L |
| 82000pF(823) | ±5%(J) | | GRM21B7U1A823JA01L | GRM31M7U1H823JA01L |
| 100000pF(104) | ±5%(J) | | GRM21B7U1A104JA01L | GRM31M7U1H104JA01L |

The part number code is shown in () and Unit is shown in []. < >: EIA [inch] Code

(Part Number) **GR** **M** **18** **8** **7U** **1H** **102** **J** **A01** **D** ①Product ID ②Series ③Dimensions (LxW) ④Dimension (T)
 ⑤Temperature Characteristics ⑥Rated Voltage ⑦Capacitance
 ⑧Capacitance Tolerance ⑨Individual Specification Code ⑩Packaging

Packaging Code in Part Number shows STD 180mm Reel Taping.

Temperature Compensating Type U2J(7U) Characteristics-Low Profile

| LxW [mm] | | 1.6x0.8(18)<0603> | |
|-------------------|-----------|--------------------|--------------------|
| Rated Volt. [Vdc] | | 50(1H) | 10(1A) |
| Capacitance | Tolerance | Part Number | |
| 2200pF(222) | ±5%(J) | GRM1857U1H222JA44D | |
| 2700pF(272) | ±5%(J) | GRM1857U1H272JA44D | |
| 3300pF(332) | ±5%(J) | GRM1857U1H332JA44D | |
| 3900pF(392) | ±5%(J) | GRM1857U1H392JA44D | |
| 4700pF(472) | ±5%(J) | GRM1857U1H472JA44D | |
| 5600pF(562) | ±5%(J) | | GRM1857U1A562JA44D |
| 6800pF(682) | ±5%(J) | | GRM1857U1A682JA44D |
| 8200pF(822) | ±5%(J) | | GRM1857U1A822JA44D |
| 10000pF(103) | ±5%(J) | | GRM1857U1A103JA44D |

| LxW [mm] | | 2.0x1.25(21)<0805> | | 3.2x1.6(31)<1206> |
|-------------------|-----------|--------------------|--------------------|--------------------|
| Rated Volt. [Vdc] | | 50(1H) | 10(1A) | 50(1H) |
| Capacitance | Tolerance | Part Number | | |
| 10000pF(103) | ±5%(J) | GRM2167U1H103JA01D | | |
| 12000pF(123) | ±5%(J) | GRM2167U1H123JA01D | | |
| 15000pF(153) | ±5%(J) | GRM2167U1H153JA01D | | |
| 18000pF(183) | ±5%(J) | GRM2167U1H183JA01D | | |
| 22000pF(223) | ±5%(J) | GRM2197U1H223JA01D | | |
| 27000pF(273) | ±5%(J) | GRM2197U1H273JA01D | | |
| 33000pF(333) | ±5%(J) | GRM21A7U1H333JA39L | | |
| 56000pF(563) | ±5%(J) | | GRM2197U1A563JA01D | GRM3197U1H563JA01D |
| 68000pF(683) | ±5%(J) | | | GRM31M7U1H683JA01L |
| 82000pF(823) | ±5%(J) | | | GRM31M7U1H823JA01L |
| 100000pF(104) | ±5%(J) | | | GRM31M7U1H104JA01L |

The part number code is shown in () and Unit is shown in []. < >: EIA [inch] Code

For General
GRM Series

Array
GMM Series

Low ESL
LL□ Series

High-Q
GJM Series

High Frequency
GQM Series

Monolithic Microchip
GMA Series

For Bonding
GMD Series

Product Information

Temperature Compensating Type P2H(6P), R2H(6R) Characteristics

| TC | | P2H | R2H | |
|-------------------|------------|--------------------|--------------------|--------------------|
| LxW [mm] | | 1.0x0.5(15)<0402> | 0.6x0.3(03)<0201> | 1.0x0.5(15)<0402> |
| Rated Volt. [Vdc] | | 50(1H) | 25(1E) | 50(1H) |
| Capacitance | Tolerance | Part Number | | |
| 1.0pF(1R0) | ±0.25pF(C) | GRM1556P1H1R0CZ01D | GRM0336R1E1R0CD01D | GRM1556R1H1R0CD01D |
| 2.0pF(2R0) | ±0.25pF(C) | GRM1556P1H2R0CZ01D | GRM0336R1E2R0CD01D | GRM1556R1H2R0CZ01D |
| 3.0pF(3R0) | ±0.25pF(C) | GRM1556P1H3R0CZ01D | GRM0336R1E3R0CD01D | GRM1556R1H3R0CZ01D |
| 4.0pF(4R0) | ±0.25pF(C) | GRM1556P1H4R0CZ01D | GRM0336R1E4R0CD01D | GRM1556R1H4R0CZ01D |
| 5.0pF(5R0) | ±0.25pF(C) | GRM1556P1H5R0CZ01D | GRM0336R1E5R0CD01D | GRM1556R1H5R0CZ01D |
| 6.0pF(6R0) | ±0.5pF(D) | GRM1556P1H6R0DZ01D | GRM0336R1E6R0DD01D | GRM1556R1H6R0DZ01D |
| 7.0pF(7R0) | ±0.5pF(D) | GRM1556P1H7R0DZ01D | GRM0336R1E7R0DD01D | GRM1556R1H7R0DZ01D |
| 8.0pF(8R0) | ±0.5pF(D) | GRM1556P1H8R0DZ01D | GRM0336R1E8R0DD01D | GRM1556R1H8R0DZ01D |
| 9.0pF(9R0) | ±0.5pF(D) | GRM1556P1H9R0DZ01D | GRM0336R1E9R0DD01D | GRM1556R1H9R0DZ01D |
| 10pF(100) | ±5%(J) | GRM1556P1H100JZ01D | GRM0336R1E100JD01D | GRM1556R1H100JZ01D |
| 12pF(120) | ±5%(J) | GRM1556P1H120JZ01D | GRM0336R1E120JD01D | GRM1556R1H120JZ01D |
| 15pF(150) | ±5%(J) | GRM1556P1H150JZ01D | GRM0336R1E150JD01D | GRM1556R1H150JZ01D |
| 18pF(180) | ±5%(J) | GRM1556P1H180JZ01D | GRM0336R1E180JD01D | GRM1556R1H180JZ01D |
| 22pF(220) | ±5%(J) | GRM1556P1H220JZ01D | GRM0336R1E220JD01D | GRM1556R1H220JZ01D |
| 27pF(270) | ±5%(J) | GRM1556P1H270JZ01D | GRM0336R1E270JD01D | GRM1556R1H270JZ01D |
| 33pF(330) | ±5%(J) | | GRM0336R1E330JD01D | GRM1556R1H330JZ01D |
| 39pF(390) | ±5%(J) | | GRM0336R1E390JD01D | |
| 47pF(470) | ±5%(J) | | GRM0336R1E470JD01D | |
| 56pF(560) | ±5%(J) | | GRM0336R1E560JD01D | |
| 68pF(680) | ±5%(J) | | GRM0336R1E680JD01D | |
| 82pF(820) | ±5%(J) | | GRM0336R1E820JD01D | |
| 100pF(101) | ±5%(J) | | GRM0336R1E101JD01D | |

The part number code is shown in () and Unit is shown in []. < >: EIA [inch] Code

For General GRM Series

Array GNM Series

Low ESL LL□ Series

High-Q GJM Series

High Frequency GQM Series

Monolithic Microchip GMA Series

For Bonding GMD Series

Product Information

(Part Number) **GR M 15 5 6P 1H 1R0 C Z01 D**
 ① ② ③ ④ ⑤ ⑥ ⑦ ⑧ ⑨ ⑩

- ① Product ID
- ② Series
- ③ Dimensions (LxW)
- ④ Dimension (T)
- ⑤ Temperature Characteristics
- ⑥ Rated Voltage
- ⑦ Capacitance
- ⑧ Capacitance Tolerance
- ⑨ Individual Specification Code
- ⑩ Packaging

Packaging Code in Part Number shows STD 180mm Reel Taping.

Temperature Compensating Type S2H(6S), T2H(6T) Characteristics

| TC | | S2H | | T2H | |
|-------------------|------------|--------------------|--------------------|--------------------|--------------------|
| LxW [mm] | | 0.6x0.3(03)<0201> | 1.0x0.5(15)<0402> | 0.6x0.3(03)<0201> | 1.0x0.5(15)<0402> |
| Rated Volt. [Vdc] | | 25(1E) | 50(1H) | 25(1E) | 50(1H) |
| Capacitance | Tolerance | Part Number | | | |
| 1.0pF(1R0) | ±0.25pF(C) | GRM0336S1E1R0CD01D | GRM1556S1H1R0CD01D | GRM0336T1E1R0CD01D | GRM1556T1H1R0CD01D |
| 2.0pF(2R0) | ±0.25pF(C) | GRM0336S1E2R0CD01D | GRM1556S1H2R0CZ01D | GRM0336T1E2R0CD01D | GRM1556T1H2R0CD01D |
| 3.0pF(3R0) | ±0.25pF(C) | GRM0336S1E3R0CD01D | GRM1556S1H3R0CZ01D | GRM0336T1E3R0CD01D | GRM1556T1H3R0CD01D |
| 4.0pF(4R0) | ±0.25pF(C) | GRM0336S1E4R0CD01D | GRM1556S1H4R0CZ01D | GRM0336T1E4R0CD01D | GRM1556T1H4R0CD01D |
| 5.0pF(5R0) | ±0.25pF(C) | GRM0336S1E5R0CD01D | GRM1556S1H5R0CZ01D | GRM0336T1E5R0CD01D | GRM1556T1H5R0CD01D |
| 6.0pF(6R0) | ±0.5pF(D) | GRM0336S1E6R0DD01D | GRM1556S1H6R0DZ01D | GRM0336T1E6R0DD01D | GRM1556T1H6R0DD01D |
| 7.0pF(7R0) | ±0.5pF(D) | GRM0336S1E7R0DD01D | GRM1556S1H7R0DZ01D | GRM0336T1E7R0DD01D | GRM1556T1H7R0DD01D |
| 8.0pF(8R0) | ±0.5pF(D) | GRM0336S1E8R0DD01D | GRM1556S1H8R0DZ01D | GRM0336T1E8R0DD01D | GRM1556T1H8R0DD01D |
| 9.0pF(9R0) | ±0.5pF(D) | GRM0336S1E9R0DD01D | GRM1556S1H9R0DZ01D | GRM0336T1E9R0DD01D | GRM1556T1H9R0DD01D |
| 10pF(100) | ±5%(J) | GRM0336S1E100JD01D | GRM1556S1H100JZ01D | GRM0336T1E100JD01D | GRM1556T1H100JD01D |
| 12pF(120) | ±5%(J) | GRM0336S1E120JD01D | GRM1556S1H120JZ01D | GRM0336T1E120JD01D | GRM1556T1H120JD01D |
| 15pF(150) | ±5%(J) | GRM0336S1E150JD01D | GRM1556S1H150JZ01D | GRM0336T1E150JD01D | GRM1556T1H150JD01D |
| 18pF(180) | ±5%(J) | GRM0336S1E180JD01D | GRM1556S1H180JZ01D | GRM0336T1E180JD01D | GRM1556T1H180JD01D |
| 22pF(220) | ±5%(J) | GRM0336S1E220JD01D | GRM1556S1H220JZ01D | GRM0336T1E220JD01D | GRM1556T1H220JD01D |
| 27pF(270) | ±5%(J) | GRM0336S1E270JD01D | GRM1556S1H270JZ01D | GRM0336T1E270JD01D | GRM1556T1H270JD01D |
| 33pF(330) | ±5%(J) | GRM0336S1E330JD01D | GRM1556S1H330JZ01D | GRM0336T1E330JD01D | GRM1556T1H330JD01D |
| 39pF(390) | ±5%(J) | GRM0336S1E390JD01D | GRM1556S1H390JZ01D | GRM0336T1E390JD01D | GRM1556T1H390JD01D |
| 47pF(470) | ±5%(J) | GRM0336S1E470JD01D | | GRM0336T1E470JD01D | GRM1556T1H470JD01D |
| 56pF(560) | ±5%(J) | GRM0336S1E560JD01D | | GRM0336T1E560JD01D | GRM1556T1H560JD01D |
| 68pF(680) | ±5%(J) | GRM0336S1E680JD01D | | GRM0336T1E680JD01D | GRM1556T1H680JD01D |
| 82pF(820) | ±5%(J) | GRM0336S1E820JD01D | | GRM0336T1E820JD01D | GRM1556T1H820JD01D |
| 100pF(101) | ±5%(J) | GRM0336S1E101JD01D | | GRM0336T1E101JD01D | GRM1556T1H101JD01D |

The part number code is shown in () and Unit is shown in []. < >: EIA [inch] Code

For General GRM Series

Array GNM Series

Low ESL LL□ Series

High-Q GJM Series

High Frequency GOM Series

Monolithic Microchip GMA Series

For Bonding GMD Series

Product Information

High Dielectric Constant Type X7R(R7) Characteristics

| LxW [mm] | | 0.4x0.2(02)<01005> |
|-------------------|-----------|--------------------|
| Rated Volt. [Vdc] | | 10(1A) |
| Capacitance | Tolerance | Part Number |
| 68pF(680) | ±10%(K) | GRM022R71A680KA01L |
| 100pF(101) | ±10%(K) | GRM022R71A101KA01L |
| 150pF(151) | ±10%(K) | GRM022R71A151KA01L |
| 220pF(221) | ±10%(K) | GRM022R71A221KA01L |
| 330pF(331) | ±10%(K) | GRM022R71A331KA01L |
| 470pF(471) | ±10%(K) | GRM022R71A471KA01L |

| LxW [mm] | | 0.6x0.3(03)<0201> | | | |
|-------------------|-----------|--------------------|--------------------|--------------------|--------------------|
| Rated Volt. [Vdc] | | 25(1E) | 16(1C) | 10(1A) | 6.3(0J) |
| Capacitance | Tolerance | Part Number | | | |
| 100pF(101) | ±10%(K) | GRM033R71E101KA01D | GRM033R71C101KA01D | | |
| 150pF(151) | ±10%(K) | GRM033R71E151KA01D | GRM033R71C151KA01D | | |
| 220pF(221) | ±10%(K) | GRM033R71E221KA01D | GRM033R71C221KA01D | | |
| 330pF(331) | ±10%(K) | GRM033R71E331KA01D | GRM033R71C331KA01D | | |
| 470pF(471) | ±10%(K) | GRM033R71E471KA01D | GRM033R71C471KA01D | | |
| 680pF(681) | ±10%(K) | GRM033R71E681KA01D | GRM033R71C681KA01D | | |
| 1000pF(102) | ±10%(K) | GRM033R71E102KA01D | GRM033R71C102KA01D | | |
| 1500pF(152) | ±10%(K) | GRM033R71E152KA01D | GRM033R71C152KA01D | | |
| 2200pF(222) | ±10%(K) | | GRM033R71C222KA88D | GRM033R71A222KA01D | |
| 3300pF(332) | ±10%(K) | | GRM033R71C332KA88D | GRM033R71A332KA01D | |
| 4700pF(472) | ±10%(K) | | | GRM033R71A472KA01D | GRM033R70J472KA01D |
| 6800pF(682) | ±10%(K) | | | GRM033R71A682KA01D | GRM033R70J682KA01D |
| 10000pF(103) | ±10%(K) | | | GRM033R71A103KA01D | GRM033R70J103KA01D |

The part number code is shown in () and Unit is shown in []. < >: EIA [inch] Code

For General GRM Series

Array GNM Series

Low ESL LL□ Series

High-Q GJM Series

High Frequency GQM Series

Monolithic Microchip GMA Series

For Bonding GMD Series

Product Information

(Part Number) **GR M 02 2 R7 1A 680 K A01 L**
① ② ③ ④ ⑤ ⑥ ⑦ ⑧ ⑨ ⑩

- ① Product ID ② Series
- ③ Dimensions (LxW) ④ Dimension (T)
- ⑤ Temperature Characteristics ⑥ Rated Voltage
- ⑦ Capacitance
- ⑧ Capacitance Tolerance ⑨ Individual Specification Code
- ⑩ Packaging

Packaging Code in Part Number shows STD 180mm Reel Taping.

High Dielectric Constant Type X7R(R7) Characteristics

| LxW [mm] | | 1.0x0.5(15)<0402> | | | |
|-------------------|-----------|--------------------|--------------------|--------------------|--------------------|
| Rated Volt. [Vdc] | | 100(2A) | 50(1H) | 25(1E) | 16(1C) |
| Capacitance | Tolerance | Part Number | | | |
| 220pF(221) | ±10%(K) | GRM155R72A221KA01D | GRM155R71H221KA01D | | |
| 330pF(331) | ±10%(K) | GRM155R72A331KA01D | GRM155R71H331KA01D | | |
| 470pF(471) | ±10%(K) | GRM155R72A471KA01D | GRM155R71H471KA01D | | |
| 680pF(681) | ±10%(K) | GRM155R72A681KA01D | GRM155R71H681KA01D | | |
| 1000pF(102) | ±10%(K) | GRM155R72A102KA01D | GRM155R71H102KA01D | | |
| 1500pF(152) | ±10%(K) | GRM155R72A152KA01D | GRM155R71H152KA01D | | |
| 2200pF(222) | ±10%(K) | GRM155R72A222KA01D | GRM155R71H222KA01D | | |
| 3300pF(332) | ±10%(K) | GRM155R72A332KA01D | GRM155R71H332KA01D | | |
| 4700pF(472) | ±10%(K) | GRM155R72A472KA01D | GRM155R71H472KA01D | GRM155R71E472KA01D | |
| 6800pF(682) | ±10%(K) | | GRM155R71H682KA88D | GRM155R71E682KA01D | |
| 10000pF(103) | ±10%(K) | | GRM155R71H103KA88D | GRM155R71E103KA01D | |
| 15000pF(153) | ±10%(K) | | GRM155R71H153KA12D | GRM155R71E153KA61D | GRM155R71C153KA01D |
| 22000pF(223) | ±10%(K) | | GRM155R71H223KA12D | GRM155R71E223KA61D | GRM155R71C223KA01D |
| 33000pF(333) | ±10%(K) | | | GRM155R71E333KA88D | GRM155R71C333KA01D |
| 47000pF(473) | ±10%(K) | | | GRM155R71E473KA88D | GRM155R71C473KA01D |
| 68000pF(683) | ±10%(K) | | | | GRM155R71C683KA88D |
| 0.10μF(104) | ±10%(K) | | | | GRM155R71C104KA88D |
| 0.15μF(154) | ±10%(K) | | | | GRM155R71C154KA12D |
| 0.22μF(224) | ±10%(K) | | | | GRM155R71C224KA12D |

| LxW [mm] | | 1.0x0.5(15)<0402> |
|-------------------|-----------|--------------------|
| Rated Volt. [Vdc] | | 10(1A) |
| Capacitance | Tolerance | Part Number |
| 68000pF(683) | ±10%(K) | GRM155R71A683KA01D |
| 0.10μF(104) | ±10%(K) | GRM155R71A104KA01D |

The part number code is shown in () and Unit is shown in []. < >: EIA [inch] Code

For General
GRM Series

Array
GMM Series

Low ESL
LL□ Series

High-Q
GJM Series

High Frequency
GOM Series

Monolithic Microchip
GMA Series

For Bonding
GMD Series

Product Information

High Dielectric Constant Type X7R(R7)/X7S(C7) Characteristics

| LxW [mm] | | 1.6x0.8(18)<0603> | | | |
|-------------------|-----------|--------------------|--------------------|---------------------|---------------------|
| Rated Volt. [Vdc] | | 100(2A) | 50(1H) | 25(1E) | 16(1C) |
| Capacitance | Tolerance | Part Number | | | |
| 220pF(221) | ±10%(K) | GRM188R72A221KA01D | GRM188R71H221KA01D | | |
| 330pF(331) | ±10%(K) | GRM188R72A331KA01D | GRM188R71H331KA01D | | |
| 470pF(471) | ±10%(K) | GRM188R72A471KA01D | GRM188R71H471KA01D | | |
| 680pF(681) | ±10%(K) | GRM188R72A681KA01D | GRM188R71H681KA01D | | |
| 1000pF(102) | ±10%(K) | GRM188R72A102KA01D | GRM188R71H102KA01D | | |
| 1500pF(152) | ±10%(K) | GRM188R72A152KA01D | GRM188R71H152KA01D | | |
| 2200pF(222) | ±10%(K) | GRM188R72A222KA01D | GRM188R71H222KA01D | GRM188R71E222KA01D | |
| 3300pF(332) | ±10%(K) | GRM188R72A332KA01D | GRM188R71H332KA01D | GRM188R71E332KA01D | |
| 4700pF(472) | ±10%(K) | GRM188R72A472KA01D | GRM188R71H472KA01D | GRM188R71E472KA01D | |
| 6800pF(682) | ±10%(K) | GRM188R72A682KA01D | GRM188R71H682KA01D | GRM188R71E682KA01D | |
| 10000pF(103) | ±10%(K) | GRM188R72A103KA01D | GRM188R71H103KA01D | GRM188R71E103KA01D | |
| 15000pF(153) | ±10%(K) | | GRM188R71H153KA01D | GRM188R71E153KA01D | |
| 22000pF(223) | ±10%(K) | | GRM188R71H223KA01D | GRM188R71E223KA01D | |
| 33000pF(333) | ±10%(K) | | GRM188R71H333KA61D | GRM188R71E333KA01D | |
| 47000pF(473) | ±10%(K) | | GRM188R71H473KA61D | GRM188R71E473KA01D | |
| 68000pF(683) | ±10%(K) | | GRM188R71H683KA93D | GRM188R71E683KA01D | |
| 0.10μF(104) | ±10%(K) | GRM188R72A104KA35D | GRM188R71H104KA93D | GRM188R71E104KA01D | |
| 0.15μF(154) | ±10%(K) | | | GRM188R71E154KA01D | GRM188R71C154KA01D |
| 0.22μF(224) | ±10%(K) | | | GRM188R71E224KA88D | GRM188R71C224KA01D |
| 0.33μF(334) | ±10%(K) | | | | GRM188R71C334KA01D |
| 0.47μF(474) | ±10%(K) | | | GRM188R71E474KA12D* | GRM188R71C474KA88D |
| 0.68μF(684) | ±10%(K) | | | | GRM188C71C684KA12D* |
| 1.0μF(105) | ±10%(K) | | | GRM188R71E105KA12D* | GRM188R71C105KA12D* |

| LxW [mm] | | 1.6x0.8(18)<0603> | | |
|-------------------|-----------|---------------------|---------------------|---------------------|
| Rated Volt. [Vdc] | | 10(1A) | 6.3(0J) | 4(0G) |
| Capacitance | Tolerance | Part Number | | |
| 0.33μF(334) | ±10%(K) | GRM188R71A334KA61D | | |
| 0.47μF(474) | ±10%(K) | GRM188R71A474KA61D | | |
| 0.68μF(684) | ±10%(K) | GRM188R71A684KA61D | | |
| 1.0μF(105) | ±10%(K) | GRM188R71A105KA61D* | | |
| 2.2μF(225) | ±10%(K) | GRM188R71A225KE15D* | GRM188C70J225KE20D* | GRM188C70G225KE20D* |

The part number code is shown in () and Unit is shown in []. < >: EIA [inch] Code
 * Please refer to GRM Series Specifications and Test Method (2).

For General GRM Series

Array GNM Series

Low ESL LL□ Series

High-Q GJM Series

High Frequency GQM Series

Monolithic Microchip GMA Series

For Bonding GMD Series

Product Information

- (Part Number) GR M 18 8 R7 2A 221 K A01 D ① Product ID ② Series ③ Dimensions (LxW) ④ Dimension (T)
- ⑤ Temperature Characteristics ⑥ Rated Voltage ⑦ Capacitance
- ⑧ Capacitance Tolerance ⑨ Individual Specification Code ⑩ Packaging

Packaging Code in Part Number shows STD 180mm Reel Taping.

High Dielectric Constant Type X7R(R7)/X7U(E7) Characteristics

| LxW [mm] | | 2.0x1.25(21)<0805> | | | |
|-------------------|-----------|--------------------|--------------------|--|---------------------|
| Rated Volt. [Vdc] | | 100(2A) | 50(1H) | 25(1E) | 16(1C) |
| Capacitance | Tolerance | Part Number | | | |
| 6800pF(682) | ±10%(K) | GRM219R72A682KA01D | | | |
| 10000pF(103) | ±10%(K) | GRM21BR72A103KA01L | | | |
| 15000pF(153) | ±10%(K) | GRM21BR72A153KA01L | | | |
| 22000pF(223) | ±10%(K) | GRM21BR72A223KA01L | | | |
| 33000pF(333) | ±10%(K) | GRM21BR72A333KA01L | GRM219R71H333KA01D | | |
| 47000pF(473) | ±10%(K) | GRM21BR72A473KA01L | GRM21BR71H473KA01L | | |
| 68000pF(683) | ±10%(K) | | GRM21BR71H683KA01L | GRM219R71E683KA01D | |
| 0.10μF(104) | ±10%(K) | | GRM21BR71H104KA01L | GRM21BR71E104KA01L | |
| 0.15μF(154) | ±10%(K) | | GRM21BR71H154KA01L | GRM21BR71E154KA01L | |
| 0.22μF(224) | ±10%(K) | GRM21AR72A224KAC5L | GRM21BR71H224KA01L | GRM21BR71E224KA01L | |
| 0.33μF(334) | ±10%(K) | GRM21AR72A334KAC5L | GRM219R71H334KA88D | GRM21BR71E334KA01L | |
| 0.47μF(474) | ±10%(K) | GRM21BR72A474KA73L | GRM21BR71H474KA88L | GRM219R71E474KA88D | |
| 0.68μF(684) | ±10%(K) | | | GRM219R71E684KA88D | GRM219R71C684KA01D |
| 1.0μF(105) | ±10%(K) | | GRM21BR71H105KA12L | GRM21BR71E105KA99L GRM219R71E105KA88D | GRM21BR71C105KA01L |
| 2.2μF(225) | ±10%(K) | | | GRM21BR71E225KA73L* | GRM21BR71C225KA12L |
| 4.7μF(475) | ±10%(K) | | | | GRM21BR71C475KA73L* |

| LxW [mm] | | 2.0x1.25(21)<0805> | | |
|-------------------|-----------|---------------------|---------------------|---------------------|
| Rated Volt. [Vdc] | | 10(1A) | 6.3(0J) | 4(0G) |
| Capacitance | Tolerance | Part Number | | |
| 2.2μF(225) | ±10%(K) | GRM21BR71A225KA01L | | |
| 4.7μF(475) | ±10%(K) | GRM21BR71A475KA73L* | | |
| 10μF(106) | ±10%(K) | GRM21BR71A106KE51L* | GRM21BR70J106KE76L* | |
| 22μF(226) | ±20%(M) | | | GRM21BE70G226ME51L* |

The part number code is shown in () and Unit is shown in []. < >: EIA [inch] Code

* Please refer to GRM Series Specifications and Test Method (2).

For General
GRM Series

Array
GMM Series

Low ESL
LL□ Series

High-Q
GJM Series

High Frequency
GOM Series

Monolithic Microchip
GMA Series

For Bonding
GMD Series

Product Information

High Dielectric Constant Type X7R(R7)/X7U(E7) Characteristics

| LxW [mm] | | 3.2x1.6(31)<1206> | | | |
|-------------------|-----------|--------------------|--------------------|---------------------|---------------------|
| Rated Volt. [Vdc] | | 100(2A) | 50(1H) | 25(1E) | 16(1C) |
| Capacitance | Tolerance | Part Number | | | |
| 15000pF(153) | ±10%(K) | GRM319R72A153KA01L | | | |
| 22000pF(223) | ±10%(K) | GRM31MR72A223KA01L | | | |
| 33000pF(333) | ±10%(K) | GRM31MR72A333KA01L | | | |
| 47000pF(473) | ±10%(K) | GRM31MR72A473KA01L | | | |
| 68000pF(683) | ±10%(K) | GRM31MR72A683KA01L | | | |
| 0.10μF(104) | ±10%(K) | GRM319R72A104KA01D | | | |
| 0.15μF(154) | ±10%(K) | GRM31MR72A154KA01L | GRM31MR71H154KA01L | | |
| 0.22μF(224) | ±10%(K) | GRM31MR72A224KA01L | GRM31MR71H224KA01L | | |
| 0.33μF(334) | ±10%(K) | | GRM319R71H334KA01D | GRM319R71E334KA01D | |
| 0.47μF(474) | ±10%(K) | GRM31MR72A474KA35L | GRM31MR71H474KA01L | GRM319R71E474KA01D | |
| 0.68μF(684) | ±10%(K) | GRM31MR72A684KA35L | GRM31MR71H684KA88L | GRM319R71E684KA01D | |
| 1.0μF(105) | ±10%(K) | GRM31CR72A105KA01L | GRM31MR71H105KA88L | | |
| 2.2μF(225) | ±10%(K) | | GRM31CR71H225KA88L | GRM31MR71E225KA93L | GRM31MR71C225KA35L |
| 4.7μF(475) | ±10%(K) | | GRM31CR71H475KA12L | GRM31CR71E475KA88L | GRM31CR71C475KA01L |
| 10μF(106) | ±10%(K) | | | GRM31CR71E106KA12L* | GRM31CR71C106KAC7L* |

| LxW [mm] | | 3.2x1.6(31)<1206> | | |
|-------------------|-----------|---------------------|---------------------|---------------------|
| Rated Volt. [Vdc] | | 10(1A) | 6.3(0J) | 4(0G) |
| Capacitance | Tolerance | Part Number | | |
| 10μF(106) | ±10%(K) | GRM31CR71A106KA01L | | |
| 22μF(226) | ±20%(M) | GRM31CR71A226ME15L* | GRM31CR70J226ME19L* | |
| 47μF(476) | ±20%(M) | | | GRM31CE70G476ME15L* |

| LxW [mm] | | 3.2x2.5(32)<1210> | | | |
|-------------------|-----------|--------------------|--------------------|--------------------|---------------------|
| Rated Volt. [Vdc] | | 100(2A) | 50(1H) | 35(YA) | 25(1E) |
| Capacitance | Tolerance | Part Number | | | |
| 0.68μF(684) | ±10%(K) | GRM32CR72A684KA01L | | | |
| 1.0μF(105) | ±10%(K) | GRM32CR72A105KA35L | | | |
| 2.2μF(225) | ±10%(K) | GRM32ER72A225KA35L | | | |
| 4.7μF(475) | ±10%(K) | | GRM32ER71H475KA88L | | |
| 10μF(106) | ±10%(K) | | | GRM32ER7YA106KA12L | GRM32DR71E106KA12L |
| 22μF(226) | ±20%(M) | | | | GRM32ER71E226ME15L* |

| LxW [mm] | | 3.2x2.5(32)<1210> | | | |
|-------------------|-----------|---------------------|---------------------|---------------------|---------------------|
| Rated Volt. [Vdc] | | 16(1C) | 10(1A) | 6.3(0J) | 4(0G) |
| Capacitance | Tolerance | Part Number | | | |
| 22μF(226) | ±20%(M) | GRM32ER71C226MEA8L* | GRM32ER71A226ME20L* | | |
| 47μF(476) | ±20%(M) | | GRM32ER71A476ME15L* | GRM32ER70J476ME20L* | |
| 100μF(107) | ±20%(M) | | | | GRM32EE70G107ME19L* |

The part number code is shown in () and Unit is shown in []. <>: EIA [inch] Code

* Please refer to GRM Series Specifications and Test Method (2).

(Part Number) **GR M 31 9 R7 2A 153 K A01 L** ① Product ID ② Series ③ Dimensions (LxW) ④ Dimension (T)
 ⑤ Temperature Characteristics ⑥ Rated Voltage ⑦ Capacitance
 ⑧ Capacitance Tolerance ⑨ Individual Specification Code ⑩ Packaging

Packaging Code in Part Number shows STD 180mm Reel Taping.

High Dielectric Constant Type X7R(R7)/X7T(D7) Characteristics-Low Profile

| LxW [mm] | | 1.0x0.5(15)<0402> | | | 1.6x0.8(18)<0603> |
|-------------------|-----------|--------------------|--------------------|--------------------|---------------------|
| Rated Volt. [Vdc] | | 50(1H) | 25(1E) | 16(1C) | 10(1A) |
| Capacitance | Tolerance | Part Number | | | |
| 220pF(221) | ±10%(K) | GRM15XR71H221KA86D | | | |
| 330pF(331) | ±10%(K) | GRM15XR71H331KA86D | | | |
| 470pF(471) | ±10%(K) | GRM15XR71H471KA86D | | | |
| 680pF(681) | ±10%(K) | GRM15XR71H681KA86D | | | |
| 1000pF(102) | ±10%(K) | GRM15XR71H102KA86D | | | |
| 1500pF(152) | ±10%(K) | GRM15XR71H152KA86D | | | |
| 2200pF(222) | ±10%(K) | | GRM15XR71E222KA86D | | |
| 3300pF(332) | ±10%(K) | | | GRM15XR71C332KA86D | |
| 4700pF(472) | ±10%(K) | | | GRM15XR71C472KA86D | |
| 6800pF(682) | ±10%(K) | | | GRM15XR71C682KA86D | |
| 10000pF(103) | ±10%(K) | | | GRM15XR71C103KA86D | |
| 1.0μF(105) | ±10%(K) | | | | GRM185D71A105KE36D* |

| LxW [mm] | | 2.0x1.25(21)<0805> | | | |
|-------------------|-----------|--------------------|--------------------|--------------------|--------------------|
| Rated Volt. [Vdc] | | 100(2A) | 50(1H) | 25(1E) | 16(1C) |
| Capacitance | Tolerance | Part Number | | | |
| 6800pF(682) | ±10%(K) | GRM219R72A682KA01D | | | |
| 33000pF(333) | ±10%(K) | | GRM219R71H333KA01D | | |
| 68000pF(683) | ±10%(K) | | | GRM219R71E683KA01D | |
| 0.22μF(224) | ±10%(K) | GRM21AR72A224KAC5L | | | |
| 0.33μF(334) | ±10%(K) | GRM21AR72A334KAC5L | GRM219R71H334KA88D | | |
| 0.47μF(474) | ±10%(K) | | | GRM219R71E474KA88D | |
| 0.68μF(684) | ±10%(K) | | | GRM219R71E684KA88D | GRM219R71C684KA01D |
| 1.0μF(105) | ±10%(K) | | | GRM219R71E105KA88D | |

| LxW [mm] | | 3.2x1.6(31)<1206> | | | |
|-------------------|-----------|--------------------|--------------------|--------------------|----------------------|
| Rated Volt. [Vdc] | | 100(2A) | 50(1H) | 25(1E) | 16(1C) |
| Capacitance | Tolerance | Part Number | | | |
| 15000pF(153) | ±10%(K) | GRM319R72A153KA01L | | | |
| 22000pF(223) | ±10%(K) | GRM31MR72A223KA01L | | | |
| 33000pF(333) | ±10%(K) | GRM31MR72A333KA01L | | | |
| 47000pF(473) | ±10%(K) | GRM31MR72A473KA01L | | | |
| 68000pF(683) | ±10%(K) | GRM31MR72A683KA01L | | | |
| 0.10μF(104) | ±10%(K) | GRM319R72A104KA01D | | | |
| 0.15μF(154) | ±10%(K) | GRM31MR72A154KA01L | GRM31MR71H154KA01L | | |
| 0.22μF(224) | ±10%(K) | GRM31MR72A224KA01L | GRM31MR71H224KA01L | | |
| 0.33μF(334) | ±10%(K) | | GRM319R71H334KA01D | | |
| 0.47μF(474) | ±10%(K) | GRM31MR72A474KA35L | GRM31MR71H474KA01L | | |
| 0.68μF(684) | ±10%(K) | GRM31MR72A684KA35L | GRM31MR71H684KA88L | | |
| 1.0μF(105) | ±10%(K) | | GRM31MR71H105KA88L | | |
| 2.2μF(225) | ±10%(K) | | | GRM31MR71E225KA93L | GRM31MR71C225KA35L |
| 4.7μF(475) | ±10%(K) | | | | GRM319D71C475KA12D** |

| LxW [mm] | | 3.2x2.5(32)<1210> | |
|-------------------|-----------|--------------------|--------------------|
| Rated Volt. [Vdc] | | 100(2A) | 50(1H) |
| Capacitance | Tolerance | Part Number | |
| 0.68μF(684) | ±10%(K) | GRM32CR72A684KA01L | GRM32NR71H684KA01L |
| 1.0μF(105) | ±10%(K) | GRM32CR72A105KA35L | |

The part number code is shown in () and Unit is shown in []. < >: EIA [inch] Code

* Please refer to GRM Series Specifications and Test Method (2).

** These Part Numbers have individual testing conditions on Durability of GRM Series Specifications and Test Methods (2). Please refer to P60.

For General
GRM Series

Array
GMM Series

Low ESL
LL□ Series

High-Q
GJM Series

High Frequency
GOM Series

Monolithic Microchip
GMA Series

For Bonding
GMD Series

Product Information

High Dielectric Constant Type X6S(C8) Characteristics

| | | | |
|-------------------|-----------|---------------------|---------------------|
| LxW [mm] | | 0.6x0.3(03)<0201> | |
| Rated Volt. [Vdc] | | 6.3(0J) | 4(0G) |
| Capacitance | Tolerance | Part Number | |
| 15000pF(153) | ±10%(K) | GRM033C80J153KE01D* | GRM033C80G153KE01D* |
| 22000pF(223) | ±10%(K) | GRM033C80J223KE01D* | GRM033C80G223KE01D* |
| 33000pF(333) | ±10%(K) | GRM033C80J333KE01D* | GRM033C80G333KE01D* |
| 47000pF(473) | ±10%(K) | GRM033C80J473KE19D* | GRM033C80G473KE01D* |

| | | | | |
|-------------------|-----------|--------------------|----------------------|---------------------|
| LxW [mm] | | 1.0x0.5(15)<0402> | | |
| Rated Volt. [Vdc] | | 25(1E) | 6.3(0J) | 4(0G) |
| Capacitance | Tolerance | Part Number | | |
| 68000pF(683) | ±10%(K) | GRM155C81E683KA12D | | |
| 0.10μF(104) | ±10%(K) | GRM155C81E104KA12D | | |
| 0.15μF(154) | ±10%(K) | | GRM155C80J154KE01D* | GRM155C80G154KE01D* |
| 0.22μF(224) | ±10%(K) | | GRM155C80J224KE01D* | GRM155C80G224KE01D* |
| 0.33μF(334) | ±10%(K) | | GRM155C80J334KE01D* | GRM155C80G334KE01D* |
| 0.47μF(474) | ±10%(K) | | GRM155C80J474KE19D* | GRM155C80G474KE01D* |
| 0.68μF(684) | ±10%(K) | | GRM155C80J684KE15D** | GRM155C80G684KE19D* |

| | | | | | |
|-------------------|-----------|--------------------|---------------------|---------------------|----------------------|
| LxW [mm] | | 1.6x0.8(18)<0603> | | | |
| Rated Volt. [Vdc] | | 25(1E) | 10(1A) | 6.3(0J) | 4(0G) |
| Capacitance | Tolerance | Part Number | | | |
| 1.0μF(105) | ±10%(K) | GRM188C81E105KAADD | | | |
| 2.2μF(225) | ±10%(K) | | GRM188C81A225KE34D* | GRM188C80J225KE19D* | |
| 4.7μF(475) | ±10%(K) | | | | GRM188C80G475KE19D* |
| 10μF(106) | ±20%(M) | | | | GRM188C80G106ME47D** |

| | | | |
|-------------------|-----------|---------------------|--|
| LxW [mm] | | 1.6x0.8(18)<0603> | |
| Rated Volt. [Vdc] | | 2.5(0E) | |
| Capacitance | Tolerance | Part Number | |
| 10μF(106) | ±20%(M) | GRM188C80E106ME47D* | |

| | | | | | |
|-------------------|-----------|---------------------|---------------------|---------------------|----------------------|
| LxW [mm] | | 2.0x1.25(21)<0805> | | | |
| Rated Volt. [Vdc] | | 25(1E) | 16(1C) | 10(1A) | 6.3(0J) |
| Capacitance | Tolerance | Part Number | | | |
| 1.0μF(105) | ±10%(K) | | GRM216C81C105KA12D* | | |
| 2.2μF(225) | ±10%(K) | | GRM219C81C225KA12D* | | |
| 4.7μF(475) | ±10%(K) | GRM21BC81E475KA12L* | GRM21BC81C475KA88L* | GRM219C81A475KE34D* | GRM219C80J475KE19D* |
| 10μF(106) | ±10%(K) | | | GRM21BC81A106KE18L* | GRM21BC80J106KE19L* |
| | | | | | GRM219C80J106KE39D* |
| 22μF(226) | ±20%(M) | | | | GRM21BC80J226ME51L** |

| | | | |
|-------------------|-----------|---------------------|--|
| LxW [mm] | | 2.0x1.25(21)<0805> | |
| Rated Volt. [Vdc] | | 4(0G) | |
| Capacitance | Tolerance | Part Number | |
| 22μF(226) | ±20%(M) | GRM21BC80G226ME39L* | |

The part number code is shown in () and Unit is shown in []. < >: EIA [inch] Code

* Please refer to GRM Series Specifications and Test Method (2).

These Part Numbers have individual testing conditions on Durability of GRM Series Specifications and Test Methods (2). Please refer to P60.

(Part Number) **GR M 03 3 C8 0J 153 K E01 D** ①Product ID ②Series ③Dimensions (LxW) ④Dimension (T)
 ⑤Temperature Characteristics ⑥Rated Voltage ⑦Capacitance
 ⑧Capacitance Tolerance ⑨Individual Specification Code ⑩Packaging

Packaging Code in Part Number shows STD 180mm Reel Taping.

High Dielectric Constant Type X6S(C8)/X6T(D8) Characteristics

| LxW [mm] | | 3.2x1.6(31)<1206> | | | |
|-------------------|-----------|---------------------|---------------------|---------------------|---------------------|
| Rated Volt. [Vdc] | | 25(1E) | 16(1C) | 10(1A) | 6.3(0J) |
| Capacitance | Tolerance | Part Number | | | |
| 2.2μF(225) | ±10%(K) | | GRM316C81C225KA12D* | | |
| 4.7μF(475) | ±10%(K) | | GRM319C81C475KA12D* | | |
| 10μF(106) | ±10%(K) | GRM31CC81E106KE15L* | GRM31MC81C106KA12L | GRM319C81A106KA12D | GRM319C80J106KE19D* |
| 22μF(226) | ±20%(M) | | | GRM31CC81A226ME19L* | GRM31CC80J226ME19L* |
| 47μF(476) | ±20%(M) | | | | GRM31CC80J476ME18L* |

| LxW [mm] | | 3.2x1.6(31)<1206> | |
|-------------------|-----------|---------------------|--|
| Rated Volt. [Vdc] | | 4(0G) | |
| Capacitance | Tolerance | Part Number | |
| 47μF(476) | ±20%(M) | GRM31CC80G476ME19L* | |
| 100μF(107) | ±20%(M) | GRM31CD80G107ME39L* | |

| LxW [mm] | | 3.2x2.5(32)<1210> | | | |
|-------------------|-----------|---------------------|---------------------|---------------------|---------------------|
| Rated Volt. [Vdc] | | 25(1E) | 10(1A) | 6.3(0J) | 4(0G) |
| Capacitance | Tolerance | Part Number | | | |
| 10μF(106) | ±10%(K) | GRM32DC81E106KA12L | | | |
| 22μF(226) | ±20%(M) | GRM32EC81E226ME15L* | GRM32NC81A226ME19L* | | |
| 47μF(476) | ±20%(M) | | GRM32EC81A476ME19L* | GRM32EC80J476ME64L* | |
| 100μF(107) | ±20%(M) | | | GRM32EC80J107ME20L* | GRM32EC80G107ME20L* |

The part number code is shown in () and Unit is shown in []. < >: EIA [inch] Code

*: Please refer to GRM Series Specifications and Test Method(2).

High Dielectric Constant Type X6S(C8) Characteristics-Low Profile

| LxW [mm] | | 1.6x0.8(18)<0603> | |
|-------------------|-----------|---------------------|---------------------|
| Rated Volt. [Vdc] | | 10(1A) | 6.3(0J) |
| Capacitance | Tolerance | Part Number | |
| 1.0μF(105) | ±10%(K) | GRM185C81A105KE36D* | GRM185C80J105KE26D* |

| LxW [mm] | | 2.0x1.25(21)<0805> | | |
|-------------------|-----------|---------------------|---------------------|---------------------|
| Rated Volt. [Vdc] | | 16(1C) | 10(1A) | 6.3(0J) |
| Capacitance | Tolerance | Part Number | | |
| 1.0μF(105) | ±10%(K) | GRM216C81C105KA12D* | | |
| 2.2μF(225) | ±10%(K) | GRM219C81C225KA12D* | | |
| 4.7μF(475) | ±10%(K) | | GRM219C81A475KE34D* | GRM219C80J475KE19D* |
| 10μF(106) | ±10%(K) | | | GRM219C80J106KE39D* |

| LxW [mm] | | 3.2x1.6(31)<1206> | |
|-------------------|-----------|---------------------|--|
| Rated Volt. [Vdc] | | 16(1C) | |
| Capacitance | Tolerance | Part Number | |
| 2.2μF(225) | ±10%(K) | GRM316C81C225KA12D* | |
| 4.7μF(475) | ±10%(K) | GRM319C81C475KA12D* | |

| LxW [mm] | | 3.2x2.5(32)<1210> | |
|-------------------|-----------|--------------------|--|
| Rated Volt. [Vdc] | | 25(1E) | |
| Capacitance | Tolerance | Part Number | |
| 10μF(106) | ±10%(K) | GRM32DC81E106KA12L | |

The part number code is shown in () and Unit is shown in []. < >: EIA [inch] Code

* Please refer to GRM Series Specifications and Test Method (2).

For General
GRM Series

Array
GMM Series

Low ESL
LL□ Series

High-Q
GJM Series

High Frequency
GOM Series

Monolithic Microchip
GMA Series

For Bonding
GMD Series

Product Information

For General
GRM Series

Array
GJM Series

Low ESL
LL□ Series

High-Q
GJM Series

High Frequency
GQM Series

Monolithic Microchip
GMA Series

For Bonding
GMD Series

Product Information

High Dielectric Constant Type X5R(R6) Characteristics

| LxW [mm] | | 0.4x0.2(02)<01005> | |
|-------------------|-----------|---------------------|---------------------|
| Rated Volt. [Vdc] | | 10(1A) | 6.3(0J) |
| Capacitance | Tolerance | Part Number | |
| 68pF(680) | ±10%(K) | GRM022R61A680KA01L | |
| 100pF(101) | ±10%(K) | GRM022R61A101KA01L | |
| 150pF(151) | ±10%(K) | GRM022R61A151KA01L | |
| 220pF(221) | ±10%(K) | GRM022R61A221KA01L | |
| 330pF(331) | ±10%(K) | GRM022R61A331KA01L | |
| 470pF(471) | ±10%(K) | GRM022R61A471KA01L | |
| 680pF(681) | ±10%(K) | GRM022R61A681KE19L* | GRM022R60J681KE19L* |
| 1000pF(102) | ±10%(K) | GRM022R61A102KE19L* | GRM022R60J102KE19L* |
| 1500pF(152) | ±10%(K) | GRM022R61A152KE19L* | GRM022R60J152KE19L* |
| 2200pF(222) | ±10%(K) | GRM022R61A222KE19L* | GRM022R60J222KE19L* |
| 3300pF(332) | ±10%(K) | GRM022R61A332KE19L* | GRM022R60J332KE19L* |
| 4700pF(472) | ±10%(K) | GRM022R61A472KE19L* | GRM022R60J472KE19L* |
| 6800pF(682) | ±10%(K) | GRM022R61A682KE19L* | GRM022R60J682KE19L* |
| 10000pF(103) | ±10%(K) | GRM022R61A103KE19L* | GRM022R60J103KE19L* |

| LxW [mm] | | 0.6x0.3(03)<0201> | | | |
|-------------------|-----------|-------------------|--------|--------------------|---------------------|
| Rated Volt. [Vdc] | | 25(1E) | 16(1C) | 10(1A) | 6.3(0J) |
| Capacitance | Tolerance | Part Number | | | |
| 100pF(101) | ±10%(K) | | | | |
| 150pF(151) | ±10%(K) | | | | |
| 220pF(221) | ±10%(K) | | | | |
| 330pF(331) | ±10%(K) | | | | |
| 470pF(471) | ±10%(K) | | | | |
| 680pF(681) | ±10%(K) | | | | |
| 1000pF(102) | ±10%(K) | | | | |
| 1500pF(152) | ±10%(K) | | | GRM033R61A152KA01D | |
| 2200pF(222) | ±10%(K) | | | GRM033R61A222KA01D | |
| 3300pF(332) | ±10%(K) | | | GRM033R61A332KA01D | |
| 4700pF(472) | ±10%(K) | | | GRM033R61A472KA01D | |
| 6800pF(682) | ±10%(K) | | | GRM033R61A682KA01D | |
| 10000pF(103) | ±10%(K) | | | GRM033R61A103KA01D | GRM033R60J103KA01D |
| 15000pF(153) | ±10%(K) | | | | GRM033R60J153KE01D* |
| 22000pF(223) | ±10%(K) | | | | GRM033R60J223KE01D* |
| 33000pF(333) | ±10%(K) | | | | GRM033R60J333KE01D* |
| 47000pF(473) | ±10%(K) | | | | GRM033R60J473KE19D* |

The part number code is shown in () and Unit is shown in []. <->: EIA [inch] Code

□: Please refer to X7R(R7) etc. Characteristics.

* Please refer to GRM Series Specifications and Test Method (2).

- (Part Number) **GR** **M** **02** **2** **R6** **1A** **680** **K** **A01** **L**
- ① Product ID
 - ② Series
 - ③ Dimensions (LxW)
 - ④ Dimension (T)
 - ⑤ Temperature Characteristics
 - ⑥ Rated Voltage
 - ⑦ Capacitance
 - ⑧ Capacitance Tolerance
 - ⑨ Individual Specification Code
 - ⑩ Packaging*

Packaging Code in Part Number shows STD 180mm Reel Taping.

*GRM022: D is applicable.

High Dielectric Constant Type X5R(R) Characteristics

| LxW [mm] | | 1.0x0.5(15)<0402> | | | |
|-------------------|-----------|-------------------|--------------------|--------------------|--------------------|
| Rated Volt. [Vdc] | | 100(2A) | 50(1H) | 25(1E) | 16(1C) |
| Capacitance | Tolerance | Part Number | | | |
| 220pF(221) | ±10%(K) | | | | |
| 330pF(331) | ±10%(K) | | | | |
| 470pF(471) | ±10%(K) | | | | |
| 680pF(681) | ±10%(K) | | | | |
| 1000pF(102) | ±10%(K) | | GRM155R61H102KA01D | | |
| 1500pF(152) | ±10%(K) | | | | |
| 2200pF(222) | ±10%(K) | | GRM155R61H222KA01D | | |
| 3300pF(332) | ±10%(K) | | | | |
| 4700pF(472) | ±10%(K) | | GRM155R61H472KA01D | | |
| 6800pF(682) | ±10%(K) | | | | |
| 10000pF(103) | ±10%(K) | | | | |
| 15000pF(153) | ±10%(K) | | | | |
| 22000pF(223) | ±10%(K) | | | | GRM155R61C223KA01D |
| 33000pF(333) | ±10%(K) | | | | GRM155R61C333KA01D |
| 47000pF(473) | ±10%(K) | | | | GRM155R61C473KA01D |
| 68000pF(683) | ±10%(K) | | | GRM155R61E683KA87D | GRM155R61C683KA88D |
| 0.10μF(104) | ±10%(K) | | | GRM155R61E104KA87D | GRM155R61C104KA88D |

| LxW [mm] | | 1.0x0.5(15)<0402> | |
|-------------------|-----------|---------------------|---------------------|
| Rated Volt. [Vdc] | | 10(1A) | 6.3(0J) |
| Capacitance | Tolerance | Part Number | |
| 33000pF(333) | ±10%(K) | GRM155R61A333KA01D | |
| 47000pF(473) | ±10%(K) | GRM155R61A473KA01D | |
| 68000pF(683) | ±10%(K) | GRM155R61A683KA01D | |
| 0.10μF(104) | ±10%(K) | GRM155R61A104KA01D | |
| 0.15μF(154) | ±10%(K) | GRM155R61A154KE19D* | GRM155R60J154KE01D* |
| 0.22μF(224) | ±10%(K) | GRM155R61A224KE19D* | GRM155R60J224KE01D* |
| 0.33μF(334) | ±10%(K) | GRM155R61A334KE15D* | GRM155R60J334KE01D* |
| 0.47μF(474) | ±10%(K) | GRM155R61A474KE15D* | GRM155R60J474KE19D* |
| 0.68μF(684) | ±10%(K) | GRM155R61A684KE15D* | GRM155R60J684KE19D* |
| 1.0μF(105) | ±10%(K) | GRM155R61A105KE15D* | |

The part number code is shown in () and Unit is shown in []. < >: EIA [inch] Code

□: Please refer to X7R(R7) etc. Characteristics.

* Please refer to GRM Series Specifications and Test Method (2).

For General
GRM Series

Array
GNM Series

Low ESL
LL□ Series

High-Q
GJM Series

High Frequency
GQM Series

Monolithic Microchip
GMA Series

For Bonding
GMD Series

Product Information

High Dielectric Constant Type X5R(R6) Characteristics

| LxW [mm] | | 1.6x0.8(18)<0603> | | | |
|-------------------|-----------|-------------------|--------------------|---------------------|---------------------|
| Rated Volt. [Vdc] | | 100(2A) | 50(1H) | 25(1E) | 16(1C) |
| Capacitance | Tolerance | Part Number | | | |
| 220pF(221) | ±10%(K) | | | | |
| 330pF(331) | ±10%(K) | | | | |
| 470pF(471) | ±10%(K) | | | | |
| 680pF(681) | ±10%(K) | | | | |
| 1000pF(102) | ±10%(K) | | GRM188R61H102KA01D | | |
| 1500pF(152) | ±10%(K) | | | | |
| 2200pF(222) | ±10%(K) | | GRM188R61H222KA01D | | |
| 3300pF(332) | ±10%(K) | | | | |
| 4700pF(472) | ±10%(K) | | GRM188R61H472KA01D | | |
| 6800pF(682) | ±10%(K) | | | | |
| 10000pF(103) | ±10%(K) | | GRM188R61H103KA01D | | |
| 15000pF(153) | ±10%(K) | | | | |
| 22000pF(223) | ±10%(K) | | GRM188R61H223KA01D | | |
| 33000pF(333) | ±10%(K) | | | | |
| 47000pF(473) | ±10%(K) | | | | |
| 68000pF(683) | ±10%(K) | | | | |
| 0.10μF(104) | ±10%(K) | | | GRM188R61E104KA01D | |
| 0.15μF(154) | ±10%(K) | | | | |
| 0.22μF(224) | ±10%(K) | | | GRM188R61E224KA88D | GRM188R61C224KA88D |
| 0.33μF(334) | ±10%(K) | | | | |
| 0.47μF(474) | ±10%(K) | | | GRM188R61E474KA12D* | GRM188R61C474KA93D* |
| 1.0μF(105) | ±10%(K) | | | GRM188R61E105KA12D* | GRM188R61C105KA93D* |
| 2.2μF(225) | ±10%(K) | | | | GRM188R61C225KE15D* |

| LxW [mm] | | 1.6x0.8(18)<0603> | | |
|-------------------|-----------|---------------------|---------------------|---------------------|
| Rated Volt. [Vdc] | | 10(1A) | 6.3(0J) | 4(0G) |
| Capacitance | Tolerance | Part Number | | |
| 0.68μF(684) | ±10%(K) | GRM188R61A684KA61D | | |
| 2.2μF(225) | ±10%(K) | GRM188R61A225KE34D* | | |
| 4.7μF(475) | ±10%(K) | | GRM188R60J475KE19D* | |
| 10μF(106) | ±20%(M) | | GRM188R60J106ME47D* | GRM188R60G106ME47D* |
| 22μF(226) | ±20%(M) | | | GRM188R60G226MEA0L* |

The part number code is shown in () and Unit is shown in []. < >: EIA [inch] Code

[] : Please refer to X7R(R7) etc. Characteristics.

* Please refer to GRM Series Specifications and Test Method (2).

(Part Number) GR M 18 8 R6 1H 102 K A01 D

① Product ID
② Series

③ Dimensions (LxW)
④ Dimension (T)

⑤ Temperature Characteristics
⑥ Rated Voltage

⑦ Capacitance
⑧ Capacitance Tolerance

⑨ Individual Specification Code
⑩ Packaging

Packaging Code in Part Number shows STD 180mm Reel Taping.

High Dielectric Constant Type X5R(R6) Characteristics

| LxW [mm] | | 2.0x1.25(21)<0805> | | | |
|-------------------|-----------|--------------------|--------|---|--|
| Rated Volt. [Vdc] | | 100(2A) | 50(1H) | 25(1E) | 16(1C) |
| Capacitance | Tolerance | Part Number | | | |
| 6800pF(682) | ±10%(K) | | | | |
| 10000pF(103) | ±10%(K) | | | | |
| 15000pF(153) | ±10%(K) | | | | |
| 22000pF(223) | ±10%(K) | | | | |
| 33000pF(333) | ±10%(K) | | | | |
| 47000pF(473) | ±10%(K) | | | | |
| 68000pF(683) | ±10%(K) | | | | |
| 0.10μF(104) | ±10%(K) | | | | |
| 0.15μF(154) | ±10%(K) | | | | |
| 0.22μF(224) | ±10%(K) | | | | |
| 0.33μF(334) | ±10%(K) | | | | |
| 0.47μF(474) | ±10%(K) | | | | |
| 0.68μF(684) | ±10%(K) | | | | |
| 1.0μF(105) | ±10%(K) | | | GRM216R61E105KA12D | GRM21BR61C105KA01L GRM216R61C105KA88D* |
| 2.2μF(225) | ±10%(K) | | | GRM21BR61E225KA12L GRM219R61E225KA12D* | GRM21BR61C225KA88L* GRM219R61C225KA88D* |
| 4.7μF(475) | ±10%(K) | | | GRM21BR61E475KA12L* | GRM21BR61C475KA88L* GRM219R61C475KE15D* |
| 10μF(106) | ±10%(K) | | | | GRM21BR61C106KE15L* |

| LxW [mm] | | 2.0x1.25(21)<0805> | | |
|-------------------|-----------|--|--|---------------------|
| Rated Volt. [Vdc] | | 10(1A) | 6.3(0J) | 4(0G) |
| Capacitance | Tolerance | Part Number | | |
| 2.2μF(225) | ±10%(K) | GRM21BR61A225KA01L | | |
| 4.7μF(475) | ±10%(K) | GRM21BR61A475KA73L* GRM219R61A475KE34D* | GRM21BR60J475KA11L* | |
| 10μF(106) | ±10%(K) | GRM21BR61A106KE19L* GRM219R61A106KE44D* | GRM21BR60J106KE19L* GRM219R60J106KE19D* | |
| 22μF(226) | ±20%(M) | | GRM21BR60J226ME39L* | GRM219R60G226ME66D* |

The part number code is shown in () and Unit is shown in []. < >: EIA [inch] Code

□: Please refer to X7R(R7) etc. Characteristics.

* Please refer to GRM Series Specifications and Test Method (2).

For General
GRM Series

Array
GJM Series

Low ESL
LL□ Series

High-Q
GJM Series

High Frequency
GOM Series

Monolithic Microchip
GMA Series

For Bonding
GMD Series

Product Information

High Dielectric Constant Type X5R(R6) Characteristics

| LxW [mm] | | 3.2x1.6(31)<1206> | | | |
|-------------------|-----------|-------------------|--------------------|---------------------|---------------------|
| Rated Volt. [Vdc] | | 100(2A) | 50(1H) | 25(1E) | 16(1C) |
| Capacitance | Tolerance | Part Number | | | |
| 15000pF(153) | ±10%(K) | | | | |
| 22000pF(223) | ±10%(K) | | | | |
| 33000pF(333) | ±10%(K) | | | | |
| 47000pF(473) | ±10%(K) | | | | |
| 68000pF(683) | ±10%(K) | | | | |
| 0.10μF(104) | ±10%(K) | | | | |
| 0.15μF(154) | ±10%(K) | | | | |
| 0.22μF(224) | ±10%(K) | | | | |
| 0.33μF(334) | ±10%(K) | | | | |
| 0.47μF(474) | ±10%(K) | | | | |
| 0.68μF(684) | ±10%(K) | | | | |
| 1.0μF(105) | ±10%(K) | | | | |
| 2.2μF(225) | ±10%(K) | | GRM31CR61H225KA88L | GRM316R61E225KA12D* | |
| 4.7μF(475) | ±10%(K) | | | GRM31CR61E475KA88L | GRM31CR61C475KA01L |
| | | | | GRM319R61E475KA12D* | GRM319R61C475KA88D* |
| 10μF(106) | ±10%(K) | | | GRM31CR61E106KA12L* | GRM31CR61C106KA88L |
| | | | | | GRM319R61C106KE15D* |
| 22μF(226) | ±20%(M) | | | | GRM31CR61C226ME15L* |

| LxW [mm] | | 3.2x1.6(31)<1206> | | |
|-------------------|-----------|---------------------|---------------------|---------------------|
| Rated Volt. [Vdc] | | 10(1A) | 6.3(0J) | 4(0G) |
| Capacitance | Tolerance | Part Number | | |
| 10μF(106) | ±10%(K) | GRM319R61A106KE19L* | | |
| 22μF(226) | ±20%(M) | GRM31CR61A226ME19L* | GRM31CR60J226ME19L* | |
| 47μF(476) | ±20%(M) | GRM31CR61A476ME15L* | GRM31CR60J476ME19L* | |
| 100μF(107) | ±20%(M) | | GRM31CR60J107ME39L* | GRM31CR60G107ME39L* |

| LxW [mm] | | 3.2x2.5(32)<1210> | | | |
|-------------------|-----------|-------------------|--------|--------------------|---------------------|
| Rated Volt. [Vdc] | | 100(2A) | 50(1H) | 35(YA) | 25(1E) |
| Capacitance | Tolerance | Part Number | | | |
| 0.68μF(684) | ±10%(K) | | | | |
| 1.0μF(105) | ±10%(K) | | | | |
| 2.2μF(225) | ±10%(K) | | | | |
| 4.7μF(475) | ±10%(K) | | | | |
| 10μF(106) | ±10%(K) | | | GRM32ER6YA106KA12L | GRM32DR61E106KA12L |
| 22μF(226) | ±20%(M) | | | | GRM32ER61E226ME15L* |

| LxW [mm] | | 3.2x2.5(32)<1210> | | |
|-------------------|-----------|---------------------|---------------------|---------------------|
| Rated Volt. [Vdc] | | 16(1C) | 10(1A) | 6.3(0J) |
| Capacitance | Tolerance | Part Number | | |
| 22μF(226) | ±20%(M) | | | |
| 47μF(476) | ±20%(M) | GRM32ER61C476ME15L* | GRM32ER61A476ME20L* | |
| 100μF(107) | ±20%(M) | | | GRM32ER60J107ME20L* |

The part number code is shown in () and Unit is shown in []. < >: EIA [inch] Code

□ : Please refer to X7R(R7) etc. Characteristics.

* Please refer to GRM Series Specifications and Test Method (2).

(Part Number) **GR M 31 C R6 1H 225 K A88 L** ①Product ID ②Series ③Dimensions (LxW) ④Dimension (T)
 ⑤Temperature Characteristics ⑥Rated Voltage ⑦Capacitance
 ⑧Capacitance Tolerance ⑨Individual Specification Code ⑩Packaging

Packaging Code in Part Number shows STD 180mm Reel Taping.

High Dielectric Constant Type X5R(R6) Characteristics-Low Profile

| LxW [mm] | | 1.0x0.5(15)<0402> | | |
|-------------------|-----------|-------------------|--------|--------|
| Rated Volt. [Vdc] | | 16(1C) | 25(1E) | 16(1C) |
| Capacitance | Tolerance | Part Number | | |
| 220pF(221) | ±10%(K) | | | |
| 330pF(331) | ±10%(K) | | | |
| 470pF(471) | ±10%(K) | | | |
| 680pF(681) | ±10%(K) | | | |
| 1000pF(102) | ±10%(K) | | | |
| 1500pF(152) | ±10%(K) | | | |
| 2200pF(222) | ±10%(K) | | | |
| 3300pF(332) | ±10%(K) | | | |
| 4700pF(472) | ±10%(K) | | | |
| 6800pF(682) | ±10%(K) | | | |
| 10000pF(103) | ±10%(K) | | | |

| LxW [mm] | | 1.6x0.8(18)<0603> | |
|-------------------|-----------|---------------------|---------------------|
| Rated Volt. [Vdc] | | 16(1C) | 10(1A) |
| Capacitance | Tolerance | Part Number | |
| 1.0μF(105) | ±10%(K) | GRM185R61C105KE44D* | GRM185R61A105KE36D* |

| LxW [mm] | | 2.0x1.25(21)<0805> | | | |
|-------------------|-----------|--------------------|--------|---------------------|---------------------|
| Rated Volt. [Vdc] | | 100(2A) | 50(1H) | 25(1E) | 16(1C) |
| Capacitance | Tolerance | Part Number | | | |
| 6800pF(682) | ±10%(K) | | | | |
| 33000pF(333) | ±10%(K) | | | | |
| 68000pF(683) | ±10%(K) | | | | |
| 0.22μF(224) | ±10%(K) | | | | |
| 0.33μF(334) | ±10%(K) | | | | |
| 0.47μF(474) | ±10%(K) | | | | |
| 0.68μF(684) | ±10%(K) | | | | |
| 1.0μF(105) | ±10%(K) | | | GRM216R61E105KA12D | GRM216R61C105KA88D |
| 2.2μF(225) | ±10%(K) | | | GRM219R61E225KA12D* | GRM219R61C225KA88D* |
| 4.7μF(475) | ±10%(K) | | | | GRM219R61C475KE15D* |

| LxW [mm] | | 2.0x1.25(21)<0805> | | |
|-------------------|-----------|---------------------|---------------------|---------------------|
| Rated Volt. [Vdc] | | 10(1A) | 6.3(0J) | 4(0G) |
| Capacitance | Tolerance | Part Number | | |
| 4.7μF(475) | ±10%(K) | GRM219R61A475KE34D* | | |
| 10μF(106) | ±10%(K) | GRM219R61A106KE44D* | GRM219R60J106KE19D* | |
| 22μF(226) | ±20%(M) | | | GRM219R60G226ME66D* |

The part number code is shown in () and Unit is shown in []. <>: EIA [inch] Code

□: Please refer to X7R(R7) etc. Characteristics.

* Please refer to GRM Series Specifications and Test Method (2).

For General
GRM Series

Array
GMM Series

Low ESL
LL□ Series

High-Q
GJM Series

High Frequency
GOM Series

Monolithic Microchip
GMA Series

For Bonding
GMD Series

Product Information

High Dielectric Constant Type X5R(R6) Characteristics-Low Profile

| LxW [mm] | | 3.2x1.6(31)<1206> | | | |
|-------------------|-----------|-------------------|--------|---------------------|---------------------|
| Rated Volt. [Vdc] | | 100(2A) | 50(1H) | 25(1E) | 16(1C) |
| Capacitance | Tolerance | Part Number | | | |
| 15000pF(153) | ±10%(K) | | | | |
| 22000pF(223) | ±10%(K) | | | | |
| 33000pF(333) | ±10%(K) | | | | |
| 47000pF(473) | ±10%(K) | | | | |
| 68000pF(683) | ±10%(K) | | | | |
| 0.10μF(104) | ±10%(K) | | | | |
| 0.15μF(154) | ±10%(K) | | | | |
| 0.22μF(224) | ±10%(K) | | | | |
| 0.33μF(334) | ±10%(K) | | | | |
| 0.47μF(474) | ±10%(K) | | | | |
| 0.68μF(684) | ±10%(K) | | | | |
| 1.0μF(105) | ±10%(K) | | | | |
| 2.2μF(225) | ±10%(K) | | | GRM316R61E225KA12D* | |
| 4.7μF(475) | ±10%(K) | | | GRM319R61E475KA12D* | GRM319R61C475KA88D* |
| 10μF(106) | ±10%(K) | | | | GRM319R61C106KE15D* |

| LxW [mm] | | 3.2x1.6(31)<1206> |
|-------------------|-----------|---------------------|
| Rated Volt. [Vdc] | | 10(1A) |
| Capacitance | Tolerance | Part Number |
| 10μF(106) | ±10%(K) | GRM319R61A106KE19D* |

| LxW [mm] | | 3.2x2.5(32)<1210> | | |
|-------------------|-----------|-------------------|--------|--------------------|
| Rated Volt. [Vdc] | | 100(2A) | 50(1H) | 25(1E) |
| Capacitance | Tolerance | Part Number | | |
| 0.68μF(684) | ±10%(K) | | | |
| 1.0μF(105) | ±10%(K) | | | |
| 10μF(106) | ±10%(K) | | | GRM32DR61E106KA12L |

The part number code is shown in () and Unit is shown in []. < >: EIA [inch] Code

□ : Please refer to X7R(R7) etc. Characteristics.

* Please refer to GRM Series Specifications and Test Method (2).

(Part Number) **GR** **M** **31** **6** **R6** **1E** **225** **K** **A12** **D** ①Product ID ②Series ③Dimensions (LxW) ④Dimension (T)
 ⑤Temperature Characteristics ⑥Rated Voltage ⑦Capacitance
 ⑧Capacitance Tolerance ⑨Individual Specification Code ⑩Packaging

Packaging Code in Part Number shows STD 180mm Reel Taping.

GRM Series Specifications and Test Methods (1) (Note 1)-Typical Inspection

(Note 1) These Specifications and Test Methods indicate typical inspection. Please refer to individual specifications (our product specifications or the approval sheet). When no "***" is added in PNs table, please refer to GRM Series Specifications and Test Methods (1). When "***" is added in PNs table, please refer to GRM Series Specifications and Test Methods (2).

| No. | Item | Specifications | | Test Method |
|-----|---------------------------------|--|--|--|
| | | Temperature Compensating Type | High Dielectric Type | |
| 1 | Operating Temperature Range | -55 to +125°C (2P/R/S/T, 3P/R/S/T/U, 4P/R/S/T/U: -25 to +85°C) | B1, B3, F1: -25 to +85°C R1, R7: -55 to +125°C R6: -55 to +85°C C8: -55 to +105°C E4: +10 to +85°C F5: -30 to +85°C | Reference temperature: 25°C (2Δ, 3Δ, 4Δ, B1, B3, F1, R1: 20°C) |
| 2 | Rated Voltage | See the previous pages. | | The rated voltage is defined as the maximum voltage that may be applied continuously to the capacitor. When AC voltage is superimposed on DC voltage, V ^{P-P} or V ^{O-P} , whichever is larger, should be maintained within the rated voltage range. |
| 3 | Appearance | No defects or abnormalities | | Visual inspection |
| 4 | Dimensions | Within the specified dimensions | | Using calipers (GRM02 size is based on Microscope) |
| 5 | Dielectric Strength | No defects or abnormalities | | No failure should be observed when 300%* of the rated voltage (temperature compensating type) or 250% of the rated voltage (high dielectric constant type) is applied between the terminations for 1 to 5 seconds, provided the charge/discharge current is less than 50mA. *200% for 500V |
| 6 | Insulation Resistance | C≤0.047μF: More than 10,000MΩ C>0.047μF: More than 500Ω · F C: Nominal Capacitance | | The insulation resistance should be measured with a DC voltage not exceeding the rated voltage at 20/25°C and 75%RH max. and within 2 minutes of charging, provided the charge/discharge current is less than 50mA. |
| 7 | Capacitance | Within the specified tolerance | | The capacitance/Q/D.F. should be measured at 20/25°C at the frequency and voltage shown in the table. |
| 8 | Q/ Dissipation Factor (D.F.) | 30pF and over: Q≥1000 30pF and below: Q≥400+20C C: Nominal Capacitance (pF) | [R6, R7, C8] W.V.: 100V : 0.025 max. (C<0.068μF) : 0.05 max. (C≥0.068μF) W.V.: 50/35/25V: : 0.025 max.* *GRM32D R7/R6/C8 1E106: 0.035 max. W.V.: 16/10V: 0.035 max. W.V.: 6.3/4V : 0.05 max. (C<3.3μF) : 0.1 max. (C≥3.3μF) [E4] W.V.: 25Vmin: 0.025 max. [F1, F5] W.V.: 25V min. : 0.05 max. (C<0.1μF) : 0.09 max. (C≥0.1μF) W.V.: 16/10V: 0.125 max. W.V.: 6.3V: 0.15 max. | |

| Char. | ΔC to 7U, 1X (1000pF and below) | ΔC to 7U, 1X (more than 1000pF) R6, R7, C8, F5, B1, B3, F1 | R6, R7, F5 (C>10μF) | E4 |
|-----------|---------------------------------|---|---------------------|--------------|
| Item | | | | |
| Frequency | 1±0.1MHz | 1±0.1kHz | 120±24Hz | 1±0.1kHz |
| Voltage | 0.5 to 5Vrms | 1±0.2Vrms | 0.5±0.1Vrms | 0.5±0.05Vrms |

Continued on the following page. 

For General GRM Series
Array GNM Series
Low ESL LL□ Series
High-Q GJM Series
High Frequency GOM Series
Monolithic Microchip GMA Series
For Bonding GMD Series
Product Information

GRM Series Specifications and Test Methods (1) (Note 1)-Typical Inspection

(Note 1) These Specifications and Test Methods indicate typical inspection.

Please refer to individual specifications (our product specifications or the approval sheet).
 When no "*" is added in PNs table, please refer to GRM Series Specifications and Test Methods (1).
 When "*" is added in PNs table, please refer to GRM Series Specifications and Test Methods (2).

Continued from the preceding page.

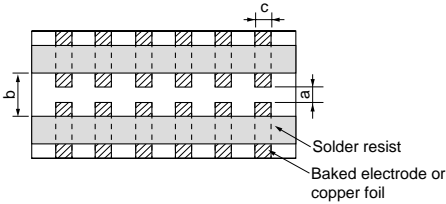
| No. | Item | Specifications | | Test Method | | | | | | | | | | | | | | | | | | | | | | | | | | | | | | | | | | | | | | |
|-------|---|--|---|--|---|------|---|---|---|-------|-----|------|------|-------|-----|-----|-----|-------|-----|-----|-----|-------|-----|-----|-----|-------|-----|-----|------|-------|-----|-----|-----|-------|-----|-----|-----|-------|-----|-----|-----|-------|
| | | Temperature Compensating Type | High Dielectric Type | | | | | | | | | | | | | | | | | | | | | | | | | | | | | | | | | | | | | | | |
| 9 | Capacitance Temperature Characteristics | No bias | B1, B3: Within $\pm 10\%$ (-25 to +85°C) R1, R7: Within $\pm 15\%$ (-55 to +125°C) R6: Within $\pm 15\%$ (-55 to +85°C) E4: Within +22/-56% (+10 to +85°C) F1: Within +30/-80% (-25 to +85°C) F5: Within +22/-82% (-30 to +85°C) C8: Within $\pm 22\%$ (-55 to +105°C) | The capacitance change should be measured after 5 min. at each specified temp. stage. (1) Temperature Compensating Type The temperature coefficient is determined using the capacitance measured in step 3 as a reference. When cycling the temperature sequentially from steps 1 through 5 (5C: +25 to +125°C/ Δ C: +20 to +125°C: other temp. coeffs.: +25 to +85°C/+20 to +85°C) the capacitance should be within the specified tolerance for the temperature coefficient and capacitance change as in Table A-1. The capacitance drift is calculated by dividing the differences between the maximum and minimum measured values in the steps 1, 3 and 5 by the cap. value in step 3. | | | | | | | | | | | | | | | | | | | | | | | | | | | | | | | | | | | | | | |
| | | 50% of the Rated Voltage | B1: Within +10/-30% R1: Within +15/-40% F1: Within +30/-95% | | | | | | | | | | | | | | | | | | | | | | | | | | | | | | | | | | | | | | | |
| | | Capacitance Drift | Within $\pm 0.2\%$ or $\pm 0.05\text{pF}$ (whichever is larger.) *Do not apply to 1X/25V | | *Initial measurement for high dielectric constant type Perform a heat treatment at 150+0/-10°C for one hour and then set for 24±2 hours at room temperature. Perform the initial measurement. | | | | | | | | | | | | | | | | | | | | | | | | | | | | | | | | | | | | | |
| 10 | Adhesive Strength of Termination | No removal of the terminations or other defect should occur. | | Solder the capacitor to the test jig (glass epoxy board) shown in Fig. 1a using a eutectic solder. Then apply 10N* force in parallel with the test jig for 10±1 sec. The soldering should be done either with an iron or using the reflow method and should be conducted with care so that the soldering is uniform and free of defects such as heat shock. *1N (GRM02), 2N (GRM03), 5N (GRM15, GRM18) | | | | | | | | | | | | | | | | | | | | | | | | | | | | | | | | | | | | | | |
| | |  <p>Fig. 1a</p> | | | (in mm) <table border="1"> <thead> <tr> <th>Type</th> <th>a</th> <th>b</th> <th>c</th> </tr> </thead> <tbody> <tr> <td>GRM02</td> <td>0.2</td> <td>0.56</td> <td>0.23</td> </tr> <tr> <td>GRM03</td> <td>0.3</td> <td>0.9</td> <td>0.3</td> </tr> <tr> <td>GRM15</td> <td>0.4</td> <td>1.5</td> <td>0.5</td> </tr> <tr> <td>GRM18</td> <td>1.0</td> <td>3.0</td> <td>1.2</td> </tr> <tr> <td>GRM21</td> <td>1.2</td> <td>4.0</td> <td>1.65</td> </tr> <tr> <td>GRM31</td> <td>2.2</td> <td>5.0</td> <td>2.0</td> </tr> <tr> <td>GRM32</td> <td>2.2</td> <td>5.0</td> <td>2.9</td> </tr> <tr> <td>GRM43</td> <td>3.5</td> <td>7.0</td> <td>3.7</td> </tr> <tr> <td>GRM55</td> <td>4.5</td> <td>8.0</td> <td>5.6</td> </tr> </tbody> </table> | Type | a | b | c | GRM02 | 0.2 | 0.56 | 0.23 | GRM03 | 0.3 | 0.9 | 0.3 | GRM15 | 0.4 | 1.5 | 0.5 | GRM18 | 1.0 | 3.0 | 1.2 | GRM21 | 1.2 | 4.0 | 1.65 | GRM31 | 2.2 | 5.0 | 2.0 | GRM32 | 2.2 | 5.0 | 2.9 | GRM43 | 3.5 | 7.0 | 3.7 | GRM55 |
| Type | a | b | c | | | | | | | | | | | | | | | | | | | | | | | | | | | | | | | | | | | | | | | |
| GRM02 | 0.2 | 0.56 | 0.23 | | | | | | | | | | | | | | | | | | | | | | | | | | | | | | | | | | | | | | | |
| GRM03 | 0.3 | 0.9 | 0.3 | | | | | | | | | | | | | | | | | | | | | | | | | | | | | | | | | | | | | | | |
| GRM15 | 0.4 | 1.5 | 0.5 | | | | | | | | | | | | | | | | | | | | | | | | | | | | | | | | | | | | | | | |
| GRM18 | 1.0 | 3.0 | 1.2 | | | | | | | | | | | | | | | | | | | | | | | | | | | | | | | | | | | | | | | |
| GRM21 | 1.2 | 4.0 | 1.65 | | | | | | | | | | | | | | | | | | | | | | | | | | | | | | | | | | | | | | | |
| GRM31 | 2.2 | 5.0 | 2.0 | | | | | | | | | | | | | | | | | | | | | | | | | | | | | | | | | | | | | | | |
| GRM32 | 2.2 | 5.0 | 2.9 | | | | | | | | | | | | | | | | | | | | | | | | | | | | | | | | | | | | | | | |
| GRM43 | 3.5 | 7.0 | 3.7 | | | | | | | | | | | | | | | | | | | | | | | | | | | | | | | | | | | | | | | |
| GRM55 | 4.5 | 8.0 | 5.6 | | | | | | | | | | | | | | | | | | | | | | | | | | | | | | | | | | | | | | | |

Continued on the following page.

GRM Series Specifications and Test Methods (1) (Note 1)-Typical Inspection

(Note 1) These Specifications and Test Methods indicate typical inspection. Please refer to individual specifications (our product specifications or the approval sheet).
 When no "*" is added in PNs table, please refer to GRM Series Specifications and Test Methods (1).
 When "*" is added in PNs table, please refer to GRM Series Specifications and Test Methods (2).

Continued from the preceding page.

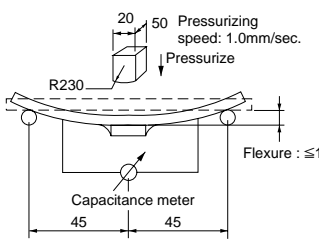
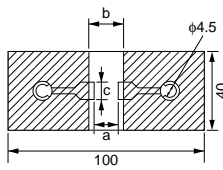
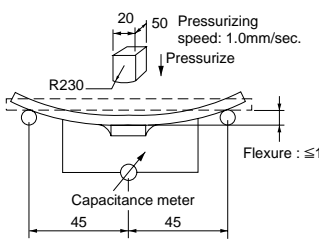
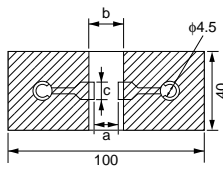
| No. | Item | Specifications | | Test Method |
|-----|------------------------------|---|----------------------|---|
| | | Temperature Compensating Type | High Dielectric Type | |
| 11 | Appearance | No defects or abnormalities | | Solder the capacitor on the test jig (glass epoxy board) in the same manner and under the same conditions as (10). The capacitor should be subjected to a simple harmonic motion having a total amplitude of 1.5mm, the frequency being varied uniformly between the approximate limits of 10 and 55Hz. The frequency range, from 10 to 55Hz and return to 10Hz, should be traversed in approximately 1 minute. This motion should be applied for a period of 2 hours in each of 3 mutually perpendicular directions (total of 6 hours). |
| | Capacitance | Within the specified tolerance | | |
| 11 | Vibration Resistance | [B1, B3, R6, R7, C8] W.V.: 100V : 0.025 max. (C<0.068μF) : 0.05 max. (C≥0.068μF) W.V.: 50/35/25V: : 0.025 max.* *GRM32D R7/R6/C8 1E106: 0.035 max. W.V.: 16/10V: 0.035 max. W.V.: 6.3/4V : 0.05 max. (C<3.3μF) : 0.1 max. (C≥3.3μF) | | |
| | Q/D.F. | 30pF and over: Q≥1000 30pF and below: Q≥400+20C C: Nominal Capacitance (pF) | | |
| 12 | Appearance | No marking defects | | Solder the capacitor on the test jig (glass epoxy board) shown in Fig. 2a using a eutectic solder. Then apply a force in the direction shown in Fig. 3a for 5±1 sec. The soldering should be done by the reflow method and should be conducted with care so that the soldering is uniform and free of defects such as heat shock. |
| | Capacitance Change | Within ±5% or ±0.5pF (whichever is larger) | Within ±10% | |
| 12 | Deflection |  | |  |
| | |  | | |
| | |  | | Type a b c GRM02 0.2 0.56 0.23 GRM03 0.3 0.9 0.3 GRM15 0.4 1.5 0.5 GRM18 1.0 3.0 1.2 GRM21 1.2 4.0 1.65 GRM31 2.2 5.0 2.0 GRM32 2.2 5.0 2.9 GRM43 3.5 7.0 3.7 GRM55 4.5 8.0 5.6 (in mm) |
| 13 | Solderability of Termination | 75% of the terminations are to be soldered evenly and continuously. | | Immerse the capacitor in a solution of ethanol (JIS-K-8101) and rosin (JIS-K-5902) (25% rosin in weight proportion). Preheat at 80 to 120°C for 10 to 30 seconds. After preheating, immerse in a eutectic solder solution for 2±0.5 seconds at 230±5°C or Sn-3.0Ag-0.5Cu solder solution for 2±0.5 seconds at 245±5°C. |

Continued on the following page. 

For General GRM Series

Array GNM Series

Low ESL LL□ Series

High-Q GJM Series

High Frequency GOM Series

Monolithic Microchip GMA Series

For Bonding GMD Series

Product Information

GRM Series Specifications and Test Methods (1) (Note 1)-Typical Inspection

(Note 1) These Specifications and Test Methods indicate typical inspection. Please refer to individual specifications (our product specifications or the approval sheet). When no "*" is added in PNs table, please refer to GRM Series Specifications and Test Methods (1). When "*" is added in PNs table, please refer to GRM Series Specifications and Test Methods (2).

Continued from the preceding page.

| No. | Item | Specifications | | Test Method |
|-----|---------------------|---|--|--|
| | | Temperature Compensating Type | High Dielectric Type | |
| 14 | | The measured and observed characteristics should satisfy the specifications in the following table. | | Preheat the capacitor at 120 to 150°C for 1 minute. Immerse the capacitor in a eutectic solder or Sn-3.0Ag-0.5Cu solder solution at 270±5°C for 10±0.5 seconds. Set at room temperature for 24±2 hours, then measure. •Initial measurement for high dielectric constant type Perform a heat treatment at 150+0/-10°C for one hour and then set at room temperature for 24±2 hours. Perform the initial measurement. •Preheating for GRM32/43/55 |
| | Appearance | No defects or abnormalities | | |
| | Capacitance Change | Within ±2.5% or ±0.25pF (whichever is larger) | B1, B3, R1, R6, R7, C8: Within ±7.5% F1, F5, E4: Within ±20% | |
| | Q/D.F. | 30pF and over: Q≥1000 30pF and below: Q≥400+20C C: Nominal Capacitance (pF) | [B1, B3, R6, R7, C8] W.V.: 100V : 0.025 max. (C<0.068μF) : 0.05 max. (C≥0.068μF) W.V.: 50/35/25V: : 0.025 max.* *GRM32D R7/R6/C8 1E106: 0.035 max. W.V.: 16/10V: 0.035 max. W.V.: 6.3/4V : 0.05 max. (C<3.3μF) : 0.1 max. (C≥3.3μF) [E4] W.V.: 25Vmin: 0.025 max. [F1, F5] W.V.: 25V min. : 0.05 max. (C<0.1μF) : 0.09 max. (C≥0.1μF) W.V.: 16/10V: 0.125 max. W.V.: 6.3V: 0.15 max. | |
| | I.R. | More than 10,000MΩ or 500Ω · F (whichever is smaller) | | |
| | Dielectric Strength | No defects | | |
| 15 | | The measured and observed characteristics should satisfy the specifications in the following table. | | Fix the capacitor to the supporting jig in the same manner and under the same conditions as (10). Perform the five cycles according to the four heat treatments shown in the following table. Set for 24±2 hours at room temperature, then measure. |
| | Appearance | No defects or abnormalities | | |
| | Capacitance Change | Within ±2.5% or ±0.25pF (whichever is larger) | B1, B3, R1, R6, R7, C8: Within ±7.5% F1, F5, E4: Within ±20% | |
| | Q/D.F. | 30pF and over: Q≥1000 30pF and below: Q≥400+20C C: Nominal Capacitance (pF) | [B1, B3, R6, R7, C8] W.V.: 100V : 0.025 max. (C<0.068μF) : 0.05 max. (C≥0.068μF) W.V.: 50/35/25V: : 0.025 max.* *GRM32D R7/R6/C8 1E106: 0.035 max. W.V.: 16/10V: 0.035 max. W.V.: 6.3/4V : 0.05 max. (C<3.3μF) : 0.1 max. (C≥3.3μF) [E4] W.V.: 25Vmin: 0.05 max. [F1, F5] W.V.: 25V min. : 0.05 max. (C<0.1μF) : 0.09 max. (C≥0.1μF) W.V.: 16/10V: 0.125 max. W.V.: 6.3V: 0.15 max. | |
| | I.R. | More than 10,000MΩ or 500Ω · F (whichever is smaller) | | |
| | Dielectric Strength | No defects | | |

| Step | Temperature | Time |
|------|--------------|--------|
| 1 | 100 to 120°C | 1 min. |
| 2 | 170 to 200°C | 1 min. |

| Step | 1 | 2 | 3 | 4 |
|-------------|----------------------------|------------|----------------------------|------------|
| Temp. (°C) | Min. Operating Temp. +0/-3 | Room Temp. | Max. Operating Temp. +3/-0 | Room Temp. |
| Time (min.) | 30±3 | 2 to 3 | 30±3 | 2 to 3 |

Continued on the following page. ↗

For General GRM Series

Array GNM Series

Low ESL LL□ Series

High-Q GJM Series

High Frequency GQM Series

Monolithic Microchip GMA Series

For Bonding GMD Series

Product Information

GRM Series Specifications and Test Methods (1) (Note 1)-Typical Inspection

(Note 1) These Specifications and Test Methods indicate typical inspection. Please refer to individual specifications (our product specifications or the approval sheet). When no "*" is added in PNs table, please refer to GRM Series Specifications and Test Methods (1). When "*" is added in PNs table, please refer to GRM Series Specifications and Test Methods (2).

Continued from the preceding page.

| No. | Item | Specifications | | Test Method | |
|-----|-------------------------|---|---|---|--|
| | | Temperature Compensating Type | High Dielectric Type | | |
| 16 | Humidity (Steady State) | The measured and observed characteristics should satisfy the specifications in the following table. | | | Set the capacitor at 40±2°C and in 90 to 95% humidity for 500±12 hours. Remove and set for 24±2 hours at room temperature, then measure. |
| | | Appearance | No defects or abnormalities | | |
| | | Capacitance Change | Within ±5% or ±0.5pF (whichever is larger) | B1, B3, R1, R6, R7, C8: Within ±12.5% F1, F5, E4: Within ±30% | |
| | | Q/D.F. | 30pF and over: Q≥350 10pF and over: Q≥275+2.5C 30pF and below: Q≥200+10C C: Nominal Capacitance (pF) | [R6, R7, C8] W.V.: 100V : 0.05 max. (C<0.068μF) : 0.075 max. (C≥0.068μF) W.V.: 50/35/25/16/10V : 0.05 max. W.V.: 6.3/4V : 0.075 max. (C<3.3μF) : 0.125 max. (C≥3.3μF) [E4] W.V.: 25Vmin: 0.05 max. [F1, F5] W.V.: 25V min. : 0.075 max. (C<0.1μF) : 0.125 max. (C≥0.1μF) W.V.: 16/10V: 0.15 max. W.V.: 6.3V: 0.2 max. | |
| | | I.R. | More than 1,000MΩ or 50Ω · F (whichever is smaller) | | |
| 17 | Humidity Load | The measured and observed characteristics should satisfy the specifications in the following table. | | | Apply the rated voltage at 40±2°C and 90 to 95% humidity for 500±12 hours. Remove and set for 24±2 hours at room temperature, then measure. The charge/discharge current is less than 50mA. •Initial measurement for F1, F5/10V max. Apply the rated DC voltage for 1 hour at 40±2°C. Remove and set for 24±2 hours at room temperature. Perform initial measurement. |
| | | Appearance | No defects or abnormalities | | |
| | | Capacitance Change | Within ±7.5% or ±0.75pF (whichever is larger) | B1, B3, R1, R6, R7, C8: Within ±12.5% F1, F5, E4: Within ±30% [W.V.: 10V max.] F1, F5: Within +30/-40% | |
| | | Q/D.F. | 30pF and over: Q≥200 30pF and below: Q≥100+10C/3 C: Nominal Capacitance (pF) | [B1, B3, R6, R7, C8] W.V.: 100V : 0.05 max. (C<0.068μF) : 0.075 max. (C≥0.068μF) W.V.: 50/35/25/16/10V : 0.05 max. W.V.: 6.3/4V : 0.075 max. (C<3.3μF) : 0.125 max. (C≥3.3μF) [E4] W.V.: 25Vmin: 0.05 max. [F1, F5] W.V.: 25V min. : 0.075 max. (C<0.1μF) : 0.125 max. (C≥0.1μF) W.V.: 16/10V: 0.15 max. W.V.: 6.3V: 0.2 max. | |
| | | I.R. | More than 500MΩ or 25Ω · F (whichever is smaller) | | |

Continued on the following page. ↗

For General GRM Series

Array GNM Series

Low ESL LL□ Series

High-Q GJM Series

High Frequency GQM Series

Monolithic Microchip GMA Series

For Bonding GMD Series

Product Information

GRM Series Specifications and Test Methods (1) (Note 1)-Typical Inspection

(Note 1) These Specifications and Test Methods indicate typical inspection.

Please refer to individual specifications (our product specifications or the approval sheet).
 When no "***" is added in PNs table, please refer to GRM Series Specifications and Test Methods (1).
 When "***" is added in PNs table, please refer to GRM Series Specifications and Test Methods (2).

Continued from the preceding page.

| No. | Item | Specifications | | Test Method |
|-----|--------------------|---|--|---|
| | | Temperature Compensating Type | High Dielectric Type | |
| 18 | | The measured and observed characteristics should satisfy the specifications in the following table. | | Apply 200%* of the rated voltage at the maximum operating temperature $\pm 3^{\circ}\text{C}$ for 1000 ± 12 hours. Set for 24 ± 2 hours at room temperature, then measure. The charge/discharge current is less than 50mA. *Initial measurement for high dielectric constant type. Apply 200% of the rated voltage* at the maximum operating temperature $\pm 3^{\circ}\text{C}$ for one hour. Remove and set for 24 ± 2 hours at room temperature. Perform initial measurement. *GRM155C81E 683/104, GRM188C81E105, GRM188C81E105, GRM21BR71H105, GRM21BR72A474, GRM21BR71C225, GRM31CR71H475, GRM32E R6/R7 YA106, GRM32D R7/R6/C8 1E106 : 150% of the rated voltage. |
| | Appearance | No defects or abnormalities | | |
| | Capacitance Change | Within $\pm 3\%$ or $\pm 0.3\text{pF}$ (whichever is larger) | B1, B3, R1, R6, R7, C8: Within $\pm 12.5\%$ F1, F5, E4: Within $\pm 30\%$ [Except 10V max. and $C \geq 1.0\mu\text{F}$] F1, F5: Within $+30/-40\%$ [10V max. and $C \geq 1.0\mu\text{F}$] | |
| | Q/D.F. | 30pF and over: $Q \geq 350$ 10pF and over: 30pF and below: $Q \geq 275+2.5C$ 10pF and below: $Q \geq 200+10C$ C: Nominal Capacitance (pF) | [B1, B3, R6, R7, C8] W.V.: 100V : 0.05 max. ($C < 0.068\mu\text{F}$) : 0.075 max. ($C \geq 0.068\mu\text{F}$) W.V.: 50/35/25/16/10V : 0.05 max. W.V.: 6.3/4V : 0.075 max. ($C < 3.3\mu\text{F}$) : 0.125 max. ($C \geq 3.3\mu\text{F}$) [E4] W.V.: 25Vmin: 0.05 max. [F1, F5] W.V.: 25V min. : 0.075 max. ($C < 0.1\mu\text{F}$) : 0.125 max. ($C \geq 0.1\mu\text{F}$) W.V.: 16/10V: 0.15 max. W.V.: 6.3V: 0.2 max. | |
| | I.R. | More than $1,000\text{M}\Omega$ or $50\Omega \cdot F$ (whichever is smaller) | | |

Table A-1
(1)

| Char. | Nominal Values (ppm/ $^{\circ}\text{C}$)*1 | Capacitance Change from 25 $^{\circ}\text{C}$ (%) | | | | | |
|-------|---|---|-------|------|-------|------|-------|
| | | -55 | | -30 | | -10 | |
| | | Max. | Min. | Max. | Min. | Max. | Min. |
| 5C | 0 \pm 30 | 0.58 | -0.24 | 0.40 | -0.17 | 0.25 | -0.11 |
| 6C | 0 \pm 60 | 0.87 | -0.48 | 0.59 | -0.33 | 0.38 | -0.21 |
| 6P | -150 \pm 60 | 2.33 | 0.72 | 1.61 | 0.50 | 1.02 | 0.32 |
| 6R | -220 \pm 60 | 3.02 | 1.28 | 2.08 | 0.88 | 1.32 | 0.56 |
| 6S | -330 \pm 60 | 4.09 | 2.16 | 2.81 | 1.49 | 1.79 | 0.95 |
| 6T | -470 \pm 60 | 5.46 | 3.28 | 3.75 | 2.26 | 2.39 | 1.44 |
| 7U | -750 \pm 120 | 8.78 | 5.04 | 6.04 | 3.47 | 3.84 | 2.21 |
| 1X | +350 to -1000 | - | - | - | - | - | - |

*1: Nominal values denote the temperature coefficient within a range of 25 $^{\circ}\text{C}$ to 125 $^{\circ}\text{C}$ (for ΔC)/85 $^{\circ}\text{C}$ (for other TC).

(2)

| Char. | Nominal Values (ppm/ $^{\circ}\text{C}$)*2 | Capacitance Change from 20 $^{\circ}\text{C}$ (%) | | | | | |
|-------|---|---|-------|------|-------|------|-------|
| | | -55 | | -25 | | -10 | |
| | | Max. | Min. | Max. | Min. | Max. | Min. |
| 2C | 0 \pm 60 | 0.82 | -0.45 | 0.49 | -0.27 | 0.33 | -0.18 |
| 3C | 0 \pm 120 | 1.37 | -0.90 | 0.82 | -0.54 | 0.55 | -0.36 |
| 4C | 0 \pm 250 | 2.56 | -1.88 | 1.54 | -1.13 | 1.02 | -0.75 |
| 2P | -150 \pm 60 | - | - | 1.32 | 0.41 | 0.88 | 0.27 |
| 3P | -150 \pm 120 | - | - | 1.65 | 0.14 | 1.10 | 0.09 |
| 4P | -150 \pm 250 | - | - | 2.36 | -0.45 | 1.57 | -0.30 |
| 2R | -220 \pm 60 | - | - | 1.70 | 0.72 | 1.13 | 0.48 |
| 3R | -220 \pm 120 | - | - | 2.03 | 0.45 | 1.35 | 0.30 |
| 4R | -220 \pm 250 | - | - | 2.74 | -0.14 | 1.83 | -0.09 |
| 2S | -330 \pm 60 | - | - | 2.30 | 1.22 | 1.54 | 0.81 |
| 3S | -330 \pm 120 | - | - | 2.63 | 0.95 | 1.76 | 0.63 |
| 4S | -330 \pm 250 | - | - | 3.35 | 0.36 | 2.23 | 0.24 |
| 2T | -470 \pm 60 | - | - | 3.07 | 1.85 | 2.05 | 1.23 |
| 3T | -470 \pm 120 | - | - | 3.40 | 1.58 | 2.27 | 1.05 |
| 4T | -470 \pm 250 | - | - | 4.12 | 0.99 | 2.74 | 0.66 |
| 3U | -750 \pm 120 | - | - | 4.94 | 2.84 | 3.29 | 1.89 |
| 4U | -750 \pm 250 | - | - | 5.65 | 2.25 | 3.77 | 1.50 |

*2: Nominal values denote the temperature coefficient within a range of 20 $^{\circ}\text{C}$ to 125 $^{\circ}\text{C}$ (for ΔC)/85 $^{\circ}\text{C}$ (for other TC).

GRM Series Specifications and Test Methods (2) (Note 1)-Typical Inspection

(Note 1) These Specifications and Test Methods indicate typical inspection.
 Please refer to individual specifications (our product specifications or the approval sheet).
 When no "*" is added in PNs table, please refer to GRM Series Specifications and Test Methods (1).
 When "*" is added in PNs table, please refer to GRM Series Specifications and Test Methods (2).

| No. | Item | Specifications | Test Method | | | | | | | | | | | | | | | | | | | | | | | | | | | | | | | | | | | | | | | | | | | | | | | | | | | | | | | | | | | | | | | | | | | | | | | |
|------------------------------|-----------------------------|---|---|------|-------------|-------------|--------|-------|----|------------|--------|-------|----|------------|--------|-------|-------|-----|--------|-------|----|-----|--------|-------|-------|-----|--------|-------|----|-----|--------|-------|----|-----|--------|-------|-------|-----|--------|----|----|-----|--------|-------|----|-----|--------|-------|-------|-----|--------|-------|----|-----|--------|-------|-------|-----|---|---------------------|---------------------|-------------------|------------------------------|----------|-------------|------------------------------|----------|-------------|---------------|----------|-------------|----------------------|----------|-------------|
| 1 | Operating Temperature Range | B1, B3, F1: -25 to +85°C R1, R7, C7, D7, E7: -55 to +125°C C6, R6: -55 to +85°C F5: -30 to +85°C C8, D8: -55 to +105°C, | Reference temperature: 25°C (B1, B3, R1, F1: 20°C) | | | | | | | | | | | | | | | | | | | | | | | | | | | | | | | | | | | | | | | | | | | | | | | | | | | | | | | | | | | | | | | | | | | | | | | |
| 2 | Rated Voltage | See the previous pages. | The rated voltage is defined as the maximum voltage that may be applied continuously to the capacitor. When AC voltage is superimposed on DC voltage, V^{P-P} or V^{O-P} , whichever is larger, should be maintained within the rated voltage range. | | | | | | | | | | | | | | | | | | | | | | | | | | | | | | | | | | | | | | | | | | | | | | | | | | | | | | | | | | | | | | | | | | | | | | | |
| 3 | Appearance | No defects or abnormalities | Visual inspection | | | | | | | | | | | | | | | | | | | | | | | | | | | | | | | | | | | | | | | | | | | | | | | | | | | | | | | | | | | | | | | | | | | | | | | |
| 4 | Dimensions | Within the specified dimensions | Using calipers (GRM02 size is based on Microscope) | | | | | | | | | | | | | | | | | | | | | | | | | | | | | | | | | | | | | | | | | | | | | | | | | | | | | | | | | | | | | | | | | | | | | | | |
| 5 | Dielectric Strength | No defects or abnormalities | No failure should be observed when 250% of the rated voltage is applied between the terminations for 1 to 5 seconds, provided the charge/discharge current is less than 50mA. | | | | | | | | | | | | | | | | | | | | | | | | | | | | | | | | | | | | | | | | | | | | | | | | | | | | | | | | | | | | | | | | | | | | | | | |
| 6 | Insulation Resistance | More than $50\Omega \cdot F$ | The insulation resistance should be measured with a DC voltage not exceeding the rated voltage at reference temperature and 75%RH max. and within 1 minutes of charging, provided the charge/discharge current is less than 50mA. | | | | | | | | | | | | | | | | | | | | | | | | | | | | | | | | | | | | | | | | | | | | | | | | | | | | | | | | | | | | | | | | | | | | | | | |
| 7 | Capacitance | Within the specified tolerance *Table 1 <table border="1"> <thead> <tr> <th>Part No.</th> <th>Case</th> <th>Temp. Coef.</th> <th>Capacitance</th> </tr> </thead> <tbody> <tr> <td>GRM022</td> <td>B3/R6</td> <td>1A</td> <td>681 to 103</td> </tr> <tr> <td>GRM155</td> <td>B3/R6</td> <td>1A</td> <td>124 to 105</td> </tr> <tr> <td>GRM185</td> <td>B3/R6</td> <td>1C/1A</td> <td>105</td> </tr> <tr> <td>GRM185</td> <td>C8/D7</td> <td>1A</td> <td>105</td> </tr> <tr> <td>GRM188</td> <td>B3/R6</td> <td>1C/1A</td> <td>225</td> </tr> <tr> <td>GRM188</td> <td>R7/C8</td> <td>1A</td> <td>225</td> </tr> <tr> <td>GRM188</td> <td>B3/R6</td> <td>1A</td> <td>335</td> </tr> <tr> <td>GRM219</td> <td>B3/R6</td> <td>1C/1A</td> <td>475</td> </tr> <tr> <td>GRM219</td> <td>C8</td> <td>1A</td> <td>475</td> </tr> <tr> <td>GRM219</td> <td>B3/R6</td> <td>1A</td> <td>106</td> </tr> <tr> <td>GRM21B</td> <td>B3/R6</td> <td>1C/1A</td> <td>106</td> </tr> <tr> <td>GRM21B</td> <td>R7/C8</td> <td>1A</td> <td>106</td> </tr> <tr> <td>GRM319</td> <td>B3/R6</td> <td>1C/1A</td> <td>106</td> </tr> </tbody> </table> | Part No. | Case | Temp. Coef. | Capacitance | GRM022 | B3/R6 | 1A | 681 to 103 | GRM155 | B3/R6 | 1A | 124 to 105 | GRM185 | B3/R6 | 1C/1A | 105 | GRM185 | C8/D7 | 1A | 105 | GRM188 | B3/R6 | 1C/1A | 225 | GRM188 | R7/C8 | 1A | 225 | GRM188 | B3/R6 | 1A | 335 | GRM219 | B3/R6 | 1C/1A | 475 | GRM219 | C8 | 1A | 475 | GRM219 | B3/R6 | 1A | 106 | GRM21B | B3/R6 | 1C/1A | 106 | GRM21B | R7/C8 | 1A | 106 | GRM319 | B3/R6 | 1C/1A | 106 | The capacitance/D.F. should be measured at reference temperature at the measuring frequency and voltage shown in the table. <table border="1"> <thead> <tr> <th>Nominal Capacitance</th> <th>Measuring Frequency</th> <th>Measuring Voltage</th> </tr> </thead> <tbody> <tr> <td>$C \leq 10\mu F$ (10V min.)*</td> <td>1±0.1kHz</td> <td>1.0±0.2Vrms</td> </tr> <tr> <td>$C \leq 10\mu F$ (6.3V max.)</td> <td>1±0.1kHz</td> <td>0.5±0.1Vrms</td> </tr> <tr> <td>$C > 10\mu F$</td> <td>120±24Hz</td> <td>0.5±0.1Vrms</td> </tr> <tr> <td>*For items in Table1</td> <td>1±0.1kHz</td> <td>0.5±0.1Vrms</td> </tr> </tbody> </table> | Nominal Capacitance | Measuring Frequency | Measuring Voltage | $C \leq 10\mu F$ (10V min.)* | 1±0.1kHz | 1.0±0.2Vrms | $C \leq 10\mu F$ (6.3V max.) | 1±0.1kHz | 0.5±0.1Vrms | $C > 10\mu F$ | 120±24Hz | 0.5±0.1Vrms | *For items in Table1 | 1±0.1kHz | 0.5±0.1Vrms |
| Part No. | Case | Temp. Coef. | Capacitance | | | | | | | | | | | | | | | | | | | | | | | | | | | | | | | | | | | | | | | | | | | | | | | | | | | | | | | | | | | | | | | | | | | | | | | |
| GRM022 | B3/R6 | 1A | 681 to 103 | | | | | | | | | | | | | | | | | | | | | | | | | | | | | | | | | | | | | | | | | | | | | | | | | | | | | | | | | | | | | | | | | | | | | | | |
| GRM155 | B3/R6 | 1A | 124 to 105 | | | | | | | | | | | | | | | | | | | | | | | | | | | | | | | | | | | | | | | | | | | | | | | | | | | | | | | | | | | | | | | | | | | | | | | |
| GRM185 | B3/R6 | 1C/1A | 105 | | | | | | | | | | | | | | | | | | | | | | | | | | | | | | | | | | | | | | | | | | | | | | | | | | | | | | | | | | | | | | | | | | | | | | | |
| GRM185 | C8/D7 | 1A | 105 | | | | | | | | | | | | | | | | | | | | | | | | | | | | | | | | | | | | | | | | | | | | | | | | | | | | | | | | | | | | | | | | | | | | | | | |
| GRM188 | B3/R6 | 1C/1A | 225 | | | | | | | | | | | | | | | | | | | | | | | | | | | | | | | | | | | | | | | | | | | | | | | | | | | | | | | | | | | | | | | | | | | | | | | |
| GRM188 | R7/C8 | 1A | 225 | | | | | | | | | | | | | | | | | | | | | | | | | | | | | | | | | | | | | | | | | | | | | | | | | | | | | | | | | | | | | | | | | | | | | | | |
| GRM188 | B3/R6 | 1A | 335 | | | | | | | | | | | | | | | | | | | | | | | | | | | | | | | | | | | | | | | | | | | | | | | | | | | | | | | | | | | | | | | | | | | | | | | |
| GRM219 | B3/R6 | 1C/1A | 475 | | | | | | | | | | | | | | | | | | | | | | | | | | | | | | | | | | | | | | | | | | | | | | | | | | | | | | | | | | | | | | | | | | | | | | | |
| GRM219 | C8 | 1A | 475 | | | | | | | | | | | | | | | | | | | | | | | | | | | | | | | | | | | | | | | | | | | | | | | | | | | | | | | | | | | | | | | | | | | | | | | |
| GRM219 | B3/R6 | 1A | 106 | | | | | | | | | | | | | | | | | | | | | | | | | | | | | | | | | | | | | | | | | | | | | | | | | | | | | | | | | | | | | | | | | | | | | | | |
| GRM21B | B3/R6 | 1C/1A | 106 | | | | | | | | | | | | | | | | | | | | | | | | | | | | | | | | | | | | | | | | | | | | | | | | | | | | | | | | | | | | | | | | | | | | | | | |
| GRM21B | R7/C8 | 1A | 106 | | | | | | | | | | | | | | | | | | | | | | | | | | | | | | | | | | | | | | | | | | | | | | | | | | | | | | | | | | | | | | | | | | | | | | | |
| GRM319 | B3/R6 | 1C/1A | 106 | | | | | | | | | | | | | | | | | | | | | | | | | | | | | | | | | | | | | | | | | | | | | | | | | | | | | | | | | | | | | | | | | | | | | | | |
| Nominal Capacitance | Measuring Frequency | Measuring Voltage | | | | | | | | | | | | | | | | | | | | | | | | | | | | | | | | | | | | | | | | | | | | | | | | | | | | | | | | | | | | | | | | | | | | | | | | |
| $C \leq 10\mu F$ (10V min.)* | 1±0.1kHz | 1.0±0.2Vrms | | | | | | | | | | | | | | | | | | | | | | | | | | | | | | | | | | | | | | | | | | | | | | | | | | | | | | | | | | | | | | | | | | | | | | | | |
| $C \leq 10\mu F$ (6.3V max.) | 1±0.1kHz | 0.5±0.1Vrms | | | | | | | | | | | | | | | | | | | | | | | | | | | | | | | | | | | | | | | | | | | | | | | | | | | | | | | | | | | | | | | | | | | | | | | | |
| $C > 10\mu F$ | 120±24Hz | 0.5±0.1Vrms | | | | | | | | | | | | | | | | | | | | | | | | | | | | | | | | | | | | | | | | | | | | | | | | | | | | | | | | | | | | | | | | | | | | | | | | |
| *For items in Table1 | 1±0.1kHz | 0.5±0.1Vrms | | | | | | | | | | | | | | | | | | | | | | | | | | | | | | | | | | | | | | | | | | | | | | | | | | | | | | | | | | | | | | | | | | | | | | | | |
| 8 | Dissipation Factor (D.F.) | B1, B3, R1, *R6, *R7, C7, C8, E7, D7: 0.1 max. C6: 0.125 max. D8: 0.15 max. F1, F5: 0.2 max. *GRM31CR71E106: 0.125 max. GRM31CR6 0J/0G 107: 0.15 max. | GRM188C80E106: Perform a heat treatment at 150+0/-10°C for one hour and then set for 24±2 hours at room temperature. | | | | | | | | | | | | | | | | | | | | | | | | | | | | | | | | | | | | | | | | | | | | | | | | | | | | | | | | | | | | | | | | | | | | | | | |

Continued on the following page. 

For General
GRM Series

Array
GMM Series

Low ESL
LL□ Series

High-Q
GJM Series

High Frequency
GOM Series

Monolithic Microchip
GMA Series

For Bonding
GMD Series

Product Information

GRM Series Specifications and Test Methods (2) (Note 1)-Typical Inspection

(Note 1) These Specifications and Test Methods indicate typical inspection.

Please refer to individual specifications (our product specifications or the approval sheet).

When no "*" is added in PNs table, please refer to GRM Series Specifications and Test Methods (1).

When "*" is added in PNs table, please refer to GRM Series Specifications and Test Methods (2).

Continued from the preceding page.

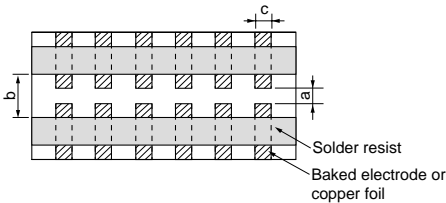
| No. | Item | Specifications | Test Method | | | | | | | | | | | | | | | | | | | | | | | | | | | | | | | | | | | | | | | | |
|-------|--|---|--|---|------|----------------------------------|----------------------|-------|--|---------|------|--|-----|--|-----|---|-----|-----------------------------|--------------------------|-------|--|-----|-----------------------------|-------|---|-----|------|-------|-----|-----|-----|-------|-----|-----|-----|-------|-----|-----|-----|-------|-----|-----|-----|
| 9 | Capacitance Temperature Characteristics | No bias B1, B3 : Within $\pm 10\%$ (-25 to $+85^\circ\text{C}$) F1 : Within $+30/-80\%$ (-25 to $+85^\circ\text{C}$) R6 : Within $\pm 15\%$ (-55 to $+85^\circ\text{C}$) R1, R7 : Within $\pm 15\%$ (-55 to $+125^\circ\text{C}$) F5 : Within $+22/-82\%$ (-30 to $+85^\circ\text{C}$) C6 : Within $\pm 22\%$ (-55 to $+85^\circ\text{C}$) C7 : Within $\pm 22\%$ (-55 to $+125^\circ\text{C}$) C8 : Within $\pm 22\%$ (-55 to $+105^\circ\text{C}$) D7 : Within $+22/-33\%$ (-55 to $+125^\circ\text{C}$) E7 : Within $+22/-56\%$ (-55 to $+125^\circ\text{C}$) D8 : Within $+22/-33\%$ (-55 to $+105^\circ\text{C}$) | The capacitance change should be measured after 5 min. at each specified temp. stage. The ranges of capacitance change compared with the reference temperature value over the temperature ranges shown in the table should be within the specified ranges.* In case of applying voltage, the capacitance change should be measured after 1 more min. with applying voltage in equilibration of each temp. stage. *GRM32DR60J226, GRM43 B1/B3/R6 0J/1A 336/476: $1.0 \pm 0.2V_{rms}$ GRM155B30G475, GRM155B30J 225, GRM21BB30J476, GRM155R60E106, GRM188 B3/R6 0E/0G/0J 226: $0.2 \pm 0.05V_{rms}$ | | | | | | | | | | | | | | | | | | | | | | | | | | | | | | | | | | | | | | | | |
| | | 50% of the Rated Voltage B1: Within $+10/-30\%$ R1: Within $+15/-40\%$ F1: Within $+30/-95\%$ | | <table border="1"> <thead> <tr> <th>Step</th> <th>Temperature ($^\circ\text{C}$)</th> <th>Applying Voltage (V)</th> </tr> </thead> <tbody> <tr> <td>1</td> <td>25 ± 2 (for R6, R7, C6, C7, C8, D7, D8, E7, F5) 20 ± 2 (for B1, B3, F1, R1)</td> <td rowspan="4">No bias</td> </tr> <tr> <td>2</td> <td>-55 ± 3 (for R1, R6, R7, C6, C7, C8, D7, D8, E7) -30 ± 3 (for F5) -25 ± 3 (for B1, B3, F1)</td> </tr> <tr> <td>3</td> <td>25 ± 2 (for R6, R7, C6, C7, C8, D7, D8, E7, F5) 20 ± 2 (for B1, B3, F1, R1)</td> </tr> <tr> <td>4</td> <td>125 ± 3 (for R1, R7, C7, D7, E7) 105 ± 3 (for C8, D8) 85 ± 3 (for B1, B3, F1, F5, R6, C6)</td> </tr> <tr> <td>5</td> <td>20 ± 2 (for B1, F1, R1)</td> <td rowspan="4">50% of the rated voltage</td> </tr> <tr> <td>6</td> <td>-55 ± 3 (for R1) -25 ± 3 (for B1, F1)</td> </tr> <tr> <td>7</td> <td>20 ± 2 (for B1, F1, R1)</td> </tr> <tr> <td>8</td> <td>125 ± 3 (for R1) 85 ± 3 (for B1, F1)</td> </tr> </tbody> </table> <p>*Initial measurement for high dielectric constant type Perform a heat treatment at $150 \pm 0/-10^\circ\text{C}$ for one hour and then set for 24 ± 2 hours at room temperature. Perform the initial measurement.</p> | Step | Temperature ($^\circ\text{C}$) | Applying Voltage (V) | 1 | 25 ± 2 (for R6, R7, C6, C7, C8, D7, D8, E7, F5) 20 ± 2 (for B1, B3, F1, R1) | No bias | 2 | -55 ± 3 (for R1, R6, R7, C6, C7, C8, D7, D8, E7) -30 ± 3 (for F5) -25 ± 3 (for B1, B3, F1) | 3 | 25 ± 2 (for R6, R7, C6, C7, C8, D7, D8, E7, F5) 20 ± 2 (for B1, B3, F1, R1) | 4 | 125 ± 3 (for R1, R7, C7, D7, E7) 105 ± 3 (for C8, D8) 85 ± 3 (for B1, B3, F1, F5, R6, C6) | 5 | 20 ± 2 (for B1, F1, R1) | 50% of the rated voltage | 6 | -55 ± 3 (for R1) -25 ± 3 (for B1, F1) | 7 | 20 ± 2 (for B1, F1, R1) | 8 | 125 ± 3 (for R1) 85 ± 3 (for B1, F1) | | | | | | | | | | | | | | | | | | |
| Step | Temperature ($^\circ\text{C}$) | Applying Voltage (V) | | | | | | | | | | | | | | | | | | | | | | | | | | | | | | | | | | | | | | | | | |
| 1 | 25 ± 2 (for R6, R7, C6, C7, C8, D7, D8, E7, F5) 20 ± 2 (for B1, B3, F1, R1) | No bias | | | | | | | | | | | | | | | | | | | | | | | | | | | | | | | | | | | | | | | | | |
| 2 | -55 ± 3 (for R1, R6, R7, C6, C7, C8, D7, D8, E7) -30 ± 3 (for F5) -25 ± 3 (for B1, B3, F1) | | | | | | | | | | | | | | | | | | | | | | | | | | | | | | | | | | | | | | | | | | |
| 3 | 25 ± 2 (for R6, R7, C6, C7, C8, D7, D8, E7, F5) 20 ± 2 (for B1, B3, F1, R1) | | | | | | | | | | | | | | | | | | | | | | | | | | | | | | | | | | | | | | | | | | |
| 4 | 125 ± 3 (for R1, R7, C7, D7, E7) 105 ± 3 (for C8, D8) 85 ± 3 (for B1, B3, F1, F5, R6, C6) | | | | | | | | | | | | | | | | | | | | | | | | | | | | | | | | | | | | | | | | | | |
| 5 | 20 ± 2 (for B1, F1, R1) | 50% of the rated voltage | | | | | | | | | | | | | | | | | | | | | | | | | | | | | | | | | | | | | | | | | |
| 6 | -55 ± 3 (for R1) -25 ± 3 (for B1, F1) | | | | | | | | | | | | | | | | | | | | | | | | | | | | | | | | | | | | | | | | | | |
| 7 | 20 ± 2 (for B1, F1, R1) | | | | | | | | | | | | | | | | | | | | | | | | | | | | | | | | | | | | | | | | | | |
| 8 | 125 ± 3 (for R1) 85 ± 3 (for B1, F1) | | | | | | | | | | | | | | | | | | | | | | | | | | | | | | | | | | | | | | | | | | |
| 10 | Adhesive Strength of Termination | No removal of the terminations or other defects should occur.  Fig. 1a | Solder the capacitor on the test jig (glass epoxy board) shown in Fig. 1a using a eutectic solder. Then apply $10N^*$ force in parallel with the test jig for 10 ± 1 sec. The soldering should be done either with an iron or using the reflow method and should be conducted with care so that the soldering is uniform and free of defects such as heat shock. *1N: GRM02, 2N: GRM03, 5N: GRM15/GRM18 <table border="1"> <thead> <tr> <th>Type</th> <th>a</th> <th>b</th> <th>c</th> </tr> </thead> <tbody> <tr> <td>GRM02</td> <td>0.2</td> <td>0.56</td> <td>0.23</td> </tr> <tr> <td>GRM03</td> <td>0.3</td> <td>0.9</td> <td>0.3</td> </tr> <tr> <td>GRM15</td> <td>0.4</td> <td>1.5</td> <td>0.5</td> </tr> <tr> <td>GRM18</td> <td>1.0</td> <td>3.0</td> <td>1.2</td> </tr> <tr> <td>GRM21</td> <td>1.2</td> <td>4.0</td> <td>1.65</td> </tr> <tr> <td>GRM31</td> <td>2.2</td> <td>5.0</td> <td>2.0</td> </tr> <tr> <td>GRM32</td> <td>2.2</td> <td>5.0</td> <td>2.9</td> </tr> <tr> <td>GRM43</td> <td>3.5</td> <td>7.0</td> <td>3.7</td> </tr> <tr> <td>GRM55</td> <td>4.5</td> <td>8.0</td> <td>5.6</td> </tr> </tbody> </table> | Type | a | b | c | GRM02 | 0.2 | 0.56 | 0.23 | GRM03 | 0.3 | 0.9 | 0.3 | GRM15 | 0.4 | 1.5 | 0.5 | GRM18 | 1.0 | 3.0 | 1.2 | GRM21 | 1.2 | 4.0 | 1.65 | GRM31 | 2.2 | 5.0 | 2.0 | GRM32 | 2.2 | 5.0 | 2.9 | GRM43 | 3.5 | 7.0 | 3.7 | GRM55 | 4.5 | 8.0 | 5.6 |
| Type | a | b | c | | | | | | | | | | | | | | | | | | | | | | | | | | | | | | | | | | | | | | | | |
| GRM02 | 0.2 | 0.56 | 0.23 | | | | | | | | | | | | | | | | | | | | | | | | | | | | | | | | | | | | | | | | |
| GRM03 | 0.3 | 0.9 | 0.3 | | | | | | | | | | | | | | | | | | | | | | | | | | | | | | | | | | | | | | | | |
| GRM15 | 0.4 | 1.5 | 0.5 | | | | | | | | | | | | | | | | | | | | | | | | | | | | | | | | | | | | | | | | |
| GRM18 | 1.0 | 3.0 | 1.2 | | | | | | | | | | | | | | | | | | | | | | | | | | | | | | | | | | | | | | | | |
| GRM21 | 1.2 | 4.0 | 1.65 | | | | | | | | | | | | | | | | | | | | | | | | | | | | | | | | | | | | | | | | |
| GRM31 | 2.2 | 5.0 | 2.0 | | | | | | | | | | | | | | | | | | | | | | | | | | | | | | | | | | | | | | | | |
| GRM32 | 2.2 | 5.0 | 2.9 | | | | | | | | | | | | | | | | | | | | | | | | | | | | | | | | | | | | | | | | |
| GRM43 | 3.5 | 7.0 | 3.7 | | | | | | | | | | | | | | | | | | | | | | | | | | | | | | | | | | | | | | | | |
| GRM55 | 4.5 | 8.0 | 5.6 | | | | | | | | | | | | | | | | | | | | | | | | | | | | | | | | | | | | | | | | |
| 11 | Vibration | Appearance | No defects or abnormalities | | | | | | | | | | | | | | | | | | | | | | | | | | | | | | | | | | | | | | | | |
| | | Capacitance | Within the specified tolerance | | | | | | | | | | | | | | | | | | | | | | | | | | | | | | | | | | | | | | | | |
| | | D.F. | B1, B3, R1, *R6, *R7, C7, C8, E7, D7: 0.1 max. C6: 0.125 max. D8: 0.15 max. F1, F5: 0.2 max. *GRM31CR71E106: 0.125 max. GRM31CR6 0J/0G 107: 0.15 max. | | | | | | | | | | | | | | | | | | | | | | | | | | | | | | | | | | | | | | | | |
| | | | Solder the capacitor on the test jig (glass epoxy board) in the same manner and under the same conditions as (10). The capacitor should be subjected to a simple harmonic motion having a total amplitude of 1.5mm, the frequency being varied uniformly between the approximate limits of 10 and 55Hz. The frequency range, from 10 to 55Hz and return to 10Hz, should be traversed in approximately 1 minute. This motion should be applied for a period of 2 hours in each of 3 mutually perpendicular directions (total of 6 hours). | | | | | | | | | | | | | | | | | | | | | | | | | | | | | | | | | | | | | | | | |

Continued on the following page.

GRM Series Specifications and Test Methods (2) (Note 1)-Typical Inspection

(Note 1) These Specifications and Test Methods indicate typical inspection. Please refer to individual specifications (our product specifications or the approval sheet).
 When no "*" is added in PNs table, please refer to GRM Series Specifications and Test Methods (1).
 When "*" is added in PNs table, please refer to GRM Series Specifications and Test Methods (2).

Continued from the preceding page.

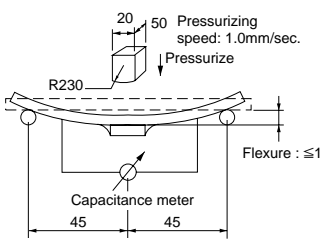
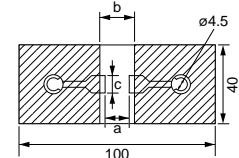
| No. | Item | Specifications | Test Method | | | | | | | | | | | | | | | | | | | | | | | | | | | | | | | | | | | | | | | | |
|---------------------|---|---|---|------------|----------------------------|------------|---|--------------|------------|----------------------------|--------------|----------------------------|------------|-------------|------|--------|------|--------|-----|-------|-----|-----|-----|-------|-----|-----|------|-------|-----|-----|-----|-------|-----|-----|-----|-------|-----|-----|-----|-------|-----|-----|-----|
| 12 | Appearance | No marking defects | Solder the capacitor on the test jig (glass epoxy board) shown in Fig. 2a using a eutectic solder. Then apply a force in the direction shown in Fig. 3a for 5±1 sec. The soldering should be done by the reflow method and should be conducted with care so that the soldering is uniform and free of defects such as heat shock. | | | | | | | | | | | | | | | | | | | | | | | | | | | | | | | | | | | | | | | | |
| | Capacitance Change | Within ±10% | | | | | | | | | | | | | | | | | | | | | | | | | | | | | | | | | | | | | | | | | |
| 12 | Deflection |  <p>Fig.3a</p> |  <p>Fig. 2a</p> <p>(GRM02/03/15: t: 0.8mm)</p> <table border="1"> <thead> <tr> <th>Type</th> <th>a</th> <th>b</th> <th>c</th> </tr> </thead> <tbody> <tr> <td>GRM02</td> <td>0.2</td> <td>0.56</td> <td>0.23</td> </tr> <tr> <td>GRM03</td> <td>0.3</td> <td>0.9</td> <td>0.3</td> </tr> <tr> <td>GRM15</td> <td>0.4</td> <td>1.5</td> <td>0.5</td> </tr> <tr> <td>GRM18</td> <td>1.0</td> <td>3.0</td> <td>1.2</td> </tr> <tr> <td>GRM21</td> <td>1.2</td> <td>4.0</td> <td>1.65</td> </tr> <tr> <td>GRM31</td> <td>2.2</td> <td>5.0</td> <td>2.0</td> </tr> <tr> <td>GRM32</td> <td>2.2</td> <td>5.0</td> <td>2.9</td> </tr> <tr> <td>GRM43</td> <td>3.5</td> <td>7.0</td> <td>3.7</td> </tr> <tr> <td>GRM55</td> <td>4.5</td> <td>8.0</td> <td>5.6</td> </tr> </tbody> </table> <p>(in mm)</p> | Type | a | b | c | GRM02 | 0.2 | 0.56 | 0.23 | GRM03 | 0.3 | 0.9 | 0.3 | GRM15 | 0.4 | 1.5 | 0.5 | GRM18 | 1.0 | 3.0 | 1.2 | GRM21 | 1.2 | 4.0 | 1.65 | GRM31 | 2.2 | 5.0 | 2.0 | GRM32 | 2.2 | 5.0 | 2.9 | GRM43 | 3.5 | 7.0 | 3.7 | GRM55 | 4.5 | 8.0 | 5.6 |
| | Type | a | b | c | | | | | | | | | | | | | | | | | | | | | | | | | | | | | | | | | | | | | | | |
| GRM02 | 0.2 | 0.56 | 0.23 | | | | | | | | | | | | | | | | | | | | | | | | | | | | | | | | | | | | | | | | |
| GRM03 | 0.3 | 0.9 | 0.3 | | | | | | | | | | | | | | | | | | | | | | | | | | | | | | | | | | | | | | | | |
| GRM15 | 0.4 | 1.5 | 0.5 | | | | | | | | | | | | | | | | | | | | | | | | | | | | | | | | | | | | | | | | |
| GRM18 | 1.0 | 3.0 | 1.2 | | | | | | | | | | | | | | | | | | | | | | | | | | | | | | | | | | | | | | | | |
| GRM21 | 1.2 | 4.0 | 1.65 | | | | | | | | | | | | | | | | | | | | | | | | | | | | | | | | | | | | | | | | |
| GRM31 | 2.2 | 5.0 | 2.0 | | | | | | | | | | | | | | | | | | | | | | | | | | | | | | | | | | | | | | | | |
| GRM32 | 2.2 | 5.0 | 2.9 | | | | | | | | | | | | | | | | | | | | | | | | | | | | | | | | | | | | | | | | |
| GRM43 | 3.5 | 7.0 | 3.7 | | | | | | | | | | | | | | | | | | | | | | | | | | | | | | | | | | | | | | | | |
| GRM55 | 4.5 | 8.0 | 5.6 | | | | | | | | | | | | | | | | | | | | | | | | | | | | | | | | | | | | | | | | |
| 13 | Solderability of Termination | 75% of the terminations is to be soldered evenly and continuously. | <p>Immerse the capacitor in a solution of ethanol (JIS-K-8101) and rosin (JIS-K-5902) (25% rosin in weight proportion). Preheat at 80 to 120°C for 10 to 30 seconds. After preheating, immerse in a eutectic solder solution for 2±0.5 seconds at 230±5°C or Sn-3.0Ag-0.5Cu solder solution for 2±0.5 seconds at 245±5°C.</p> | | | | | | | | | | | | | | | | | | | | | | | | | | | | | | | | | | | | | | | | |
| 14 | Appearance | No defects or abnormalities | <p>Preheat the capacitor at 120 to 150°C for 1 minute. Immerse the capacitor in a eutectic solder* or Sn-3.0Ag-0.5Cu solder solution at 270±5°C for 10±0.5 seconds. Set at room temperature for 24±2 hours, then measure. *Do not apply to GRM02.</p> <p>•Initial measurement for high dielectric constant type Perform a heat treatment at 150+0/-10°C for one hour and then set at room temperature for 24±2 hours. Perform the initial measurement.</p> <p>*Preheating for GRM32/43/55</p> <table border="1"> <thead> <tr> <th>Step</th> <th>Temperature</th> <th>Time</th> </tr> </thead> <tbody> <tr> <td>1</td> <td>100 to 120°C</td> <td>1 min.</td> </tr> <tr> <td>2</td> <td>170 to 200°C</td> <td>1 min.</td> </tr> </tbody> </table> | Step | Temperature | Time | 1 | 100 to 120°C | 1 min. | 2 | 170 to 200°C | 1 min. | | | | | | | | | | | | | | | | | | | | | | | | | | | | | | | |
| | Step | Temperature | | Time | | | | | | | | | | | | | | | | | | | | | | | | | | | | | | | | | | | | | | | |
| | 1 | 100 to 120°C | | 1 min. | | | | | | | | | | | | | | | | | | | | | | | | | | | | | | | | | | | | | | | |
| | 2 | 170 to 200°C | | 1 min. | | | | | | | | | | | | | | | | | | | | | | | | | | | | | | | | | | | | | | | |
| | Resistance to Soldering Heat | <p>B1, B3, R1, *R6, R7, C6, C7, *C8, E7, D7, D8: Within ±7.5% F1, F5: Within ±20% *GRM188R6 0J/0G 106, GRM188C8 0E/0G 106, GRM219R60G226: Within ±12.5% GRM155R60G475, GRM155R60E106, GRM188R60G226: Within ±15%</p> | | | | | | | | | | | | | | | | | | | | | | | | | | | | | | | | | | | | | | | | | |
| D.F. | <p>B1, B3, R1, *R6, *R7, C7, C8, E7, D7: 0.1 max. C6: 0.125 max. D8: 0.15 max. F1, F5: 0.2 max. *GRM31CR71E106: 0.125 max. GRM31CR6 0J/0G 107: 0.15 max.</p> | | | | | | | | | | | | | | | | | | | | | | | | | | | | | | | | | | | | | | | | | | |
| I.R. | More than 50Ω · F | | | | | | | | | | | | | | | | | | | | | | | | | | | | | | | | | | | | | | | | | | |
| Dielectric Strength | No defects | | | | | | | | | | | | | | | | | | | | | | | | | | | | | | | | | | | | | | | | | | |
| 15 | Appearance | No defects or abnormalities | <p>Fix the capacitor to the supporting jig in the same manner and under the same conditions as (10). Perform the five cycles according to the four heat treatments shown in the following table. Set for 24±2 hours at room temperature, then measure.</p> <table border="1"> <thead> <tr> <th>Step</th> <th>1</th> <th>2</th> <th>3</th> <th>4</th> </tr> </thead> <tbody> <tr> <td>Temp. (°C)</td> <td>Min. Operating Temp. +0/-3</td> <td>Room Temp.</td> <td>Max. Operating Temp. +3/-0</td> <td>Room Temp.</td> </tr> <tr> <td>Time (min.)</td> <td>30±3</td> <td>2 to 3</td> <td>30±3</td> <td>2 to 3</td> </tr> </tbody> </table> <p>•Initial measurement for high dielectric constant type Perform a heat treatment at 150+0/-10°C for one hour and then set at room temperature for 24±2 hours. Perform the initial measurement. GRM188R60J106 only Measurement after test Perform a heat treatment and then let sit for 24±2 hours at room temperature, then measure.</p> | Step | 1 | 2 | 3 | 4 | Temp. (°C) | Min. Operating Temp. +0/-3 | Room Temp. | Max. Operating Temp. +3/-0 | Room Temp. | Time (min.) | 30±3 | 2 to 3 | 30±3 | 2 to 3 | | | | | | | | | | | | | | | | | | | | | | | | | |
| | Step | 1 | | 2 | 3 | 4 | | | | | | | | | | | | | | | | | | | | | | | | | | | | | | | | | | | | | |
| | Temp. (°C) | Min. Operating Temp. +0/-3 | | Room Temp. | Max. Operating Temp. +3/-0 | Room Temp. | | | | | | | | | | | | | | | | | | | | | | | | | | | | | | | | | | | | | |
| | Time (min.) | 30±3 | | 2 to 3 | 30±3 | 2 to 3 | | | | | | | | | | | | | | | | | | | | | | | | | | | | | | | | | | | | | |
| | Capacitance Change | <p>B1, B3, R1, R6, R7, C6, C7, C8, D7, D8: Within ±7.5% E7: Within ±30% F1, F5: Within ±20%</p> | | | | | | | | | | | | | | | | | | | | | | | | | | | | | | | | | | | | | | | | | |
| D.F. | <p>B1, B3, R1, *R6, *R7, C7, C8, E7, D7: 0.1 max. C6: 0.125 max. D8: 0.15 max. F1, F5: 0.2 max. *GRM31CR71E106: 0.125 max. GRM31CR6 0J/0G 107: 0.15 max.</p> | | | | | | | | | | | | | | | | | | | | | | | | | | | | | | | | | | | | | | | | | | |
| I.R. | More than 50Ω · F | | | | | | | | | | | | | | | | | | | | | | | | | | | | | | | | | | | | | | | | | | |
| Dielectric Strength | No defects | | | | | | | | | | | | | | | | | | | | | | | | | | | | | | | | | | | | | | | | | | |

Continued on the following page. 

GRM Series Specifications and Test Methods (2) (Note 1)-Typical Inspection

(Note 1) These Specifications and Test Methods indicate typical inspection.
 Please refer to individual specifications (our product specifications or the approval sheet).
 When no "*" is added in PNs table, please refer to GRM Series Specifications and Test Methods (1).
 When "*" is added in PNs table, please refer to GRM Series Specifications and Test Methods (2).

Continued from the preceding page.

| No. | Item | Specifications | Test Method |
|-----|---|---|---|
| 16 | Appearance | No defects or abnormalities | Apply the rated voltage at 40±2°C and 90 to 95% humidity for 500±12 hours. The charge/discharge current is less than 50mA. •Initial measurement Perform a heat treatment at 150+0/-10°C for one hour and then let sit for 24±2 hours at room temperature. Perform the initial measurement. •Measurement after test Perform a heat treatment at 150+0/-10°C for one hour and then let sit for 24±2 hours at room temperature, then measure. |
| | High Temperature High Humidity (Steady) | Capacitance Change B1, B3, R1, R6, R7, C6, C7, C8, E7, D7, D8: Within ±12.5% F1, F5: Within ±30% | |
| | D.F. | B1, B3, R1, R6, R7, C6, C7, *C8, E7, D7, D8: 0.2 max. F1, F5: 0.4 max. *GRM319C81A106, GRM31MC81A106: 0.125 max. | |
| | I.R. | More than 12.5Ω · F | |
| 17 | Appearance | No defects or abnormalities | Apply 150%* of the rated voltage for 1000±12 hours at the maximum operating temperature ±3°C. Let sit for 24±2 hours at room temperature, then measure. The charge/discharge current is less than 50mA. * Part Numbers with # have individual specification. As for these Part Numbers, please refer to table A. •Initial measurement Perform a heat treatment at 150+0/-10°C for one hour and then let sit for 24±2 hours at room temperature. Perform the initial measurement. •Measurement after test Perform a heat treatment at 150+0/-10°C for one hour and then let sit for 24±2 hours at room temperature, then measure. |
| | Durability | Capacitance Change B1, B3, R1, *R6, R7, C6, C7, *C8, E7, D7, D8: Within ±12.5% F1, F5: Within ±30% *GRM188C8 0E/0G 106, GRM219R60G226: within ±15% | |
| | D.F. | B1, B3, R1, R6, R7, C6, C7, *C8, E7, D7, D8: 0.2 max. F1, F5: 0.4 max. *GRM319C81A106, GRM31MC81A106: 0.125 max. | |
| | I.R. | More than 25Ω · F | |

Table A

| Part Number | Dimension LxW (mm) | Temp. Char. | Rated Volt. (Vdc) | Capacitance (F) | Cap. Tol (%) | Spec. Test Methods | Applied Testing Voltage at Durability |
|--------------------|--------------------|-------------|-------------------|-----------------|--------------|--------------------|---------------------------------------|
| GRM155C80J684KE15D | 1.0X0.5 | X6S | 6.3 | 0.68μ | ±10% | (2) | Rated Volt. X100% |
| GRM155C80J684ME15D | 1.0X0.5 | X6S | 6.3 | 0.68μ | ±20% | (2) | Rated Volt. X100% |
| GRM188C80G106ME47D | 1.6X0.8 | X6S | 4 | 10μ | ±20% | (2) | Rated Volt. X100% |
| GRM21BC80J226ME51L | 2.0X1.25 | X6S | 6.3 | 22μ | ±20% | (2) | Rated Volt. X100% |
| GRM319D71C475KA12D | 3.2X1.6 | X7T | 16 | 4.7μ | ±10% | (2) | Rated Volt. X100% |
| GRM319D71C475MA12D | 3.2X1.6 | X7T | 16 | 4.7μ | ±20% | (2) | Rated Volt. X100% |

Part Numbers of table A are designed for use in the circuits where continuous applied voltage to the capacitor is derated than rated voltage. These Part Numbers guarantee Durability Test with 100% x rated voltage as testing voltage at the maximum operating temperature. The following voltage and temperature derating conditions are recommended for use to ensure the same reliability level as normal specification.

• Recommended Derating Conditions on Voltage and Temperature

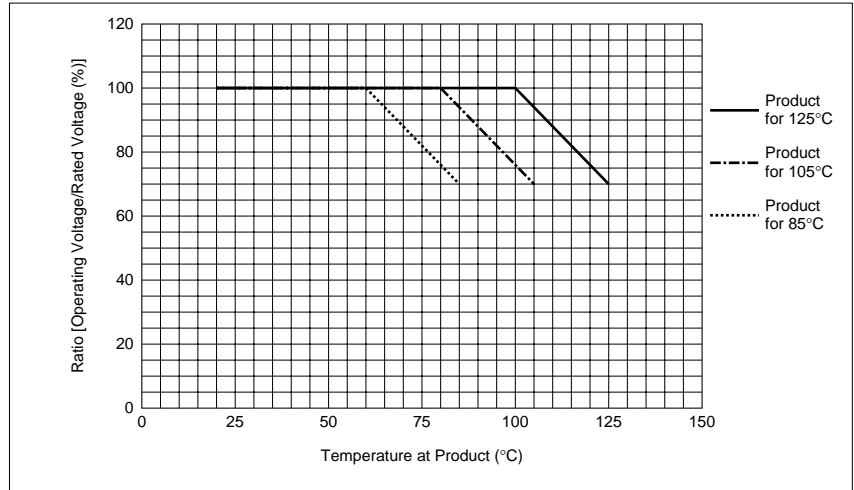

GRM Series Data

■ Capacitance - Temperature Characteristics

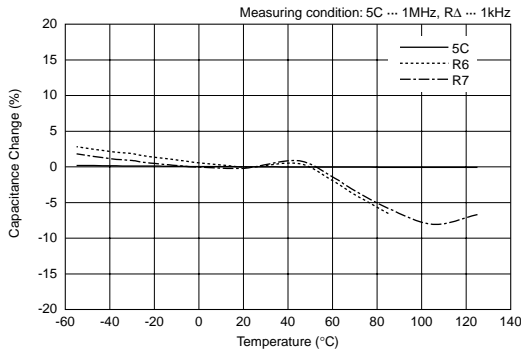

■ Capacitance Change - Aging

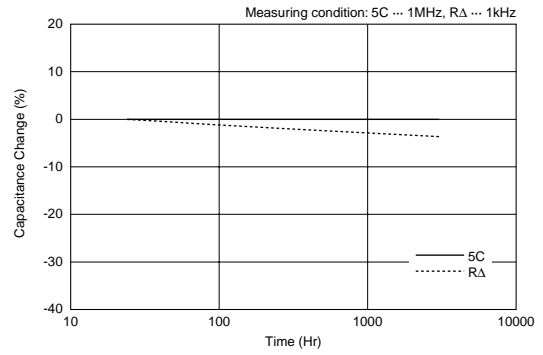

■ Impedance - Frequency Characteristics

5C: GRM15

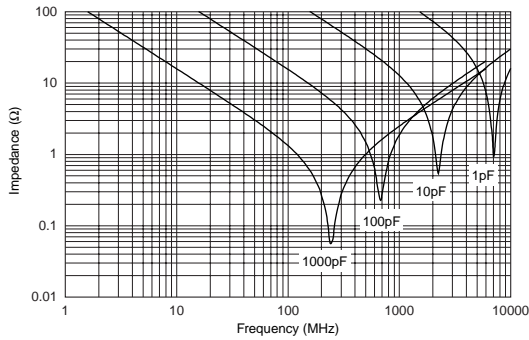

R Δ : GRM15

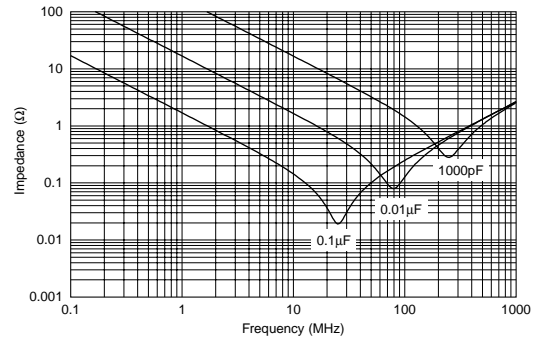

R Δ

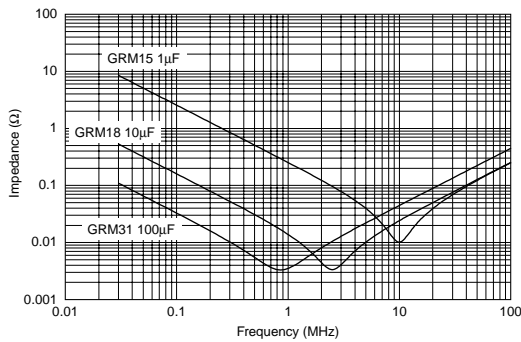

The data herein are given in typical values, not guaranteed ratings.
 Please refer to our Web site or contact our sales representatives for individual Part Number's data.
 Our Web Site: http://www.murata.com/products/capacitor/tech_data/

Continued on the following page.

For General
GRM Series

Array
GMM Series

Low ESL
LL□ Series

High-Q
GJM Series

High Frequency
GOM Series

Monolithic Microchip
GMA Series

For Bonding
GMD Series

Product Information

GRM Series Data

Continued from the preceding page.

Capacitance - DC Voltage Characteristics

Temperature Compensating Type: GRM1555C1H102JA01

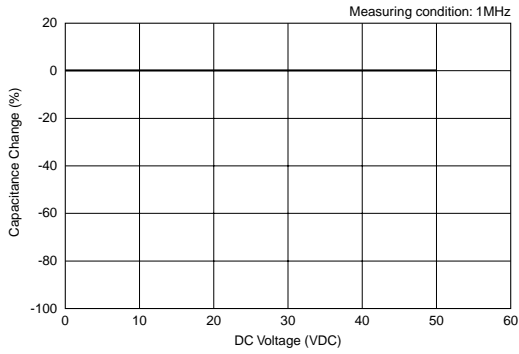

High Dielectric Constant Type: GRM155R71E103KA01

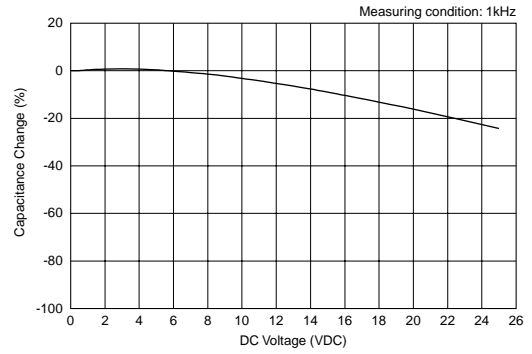

High Dielectric Constant Type: GRM155R71C104KA88

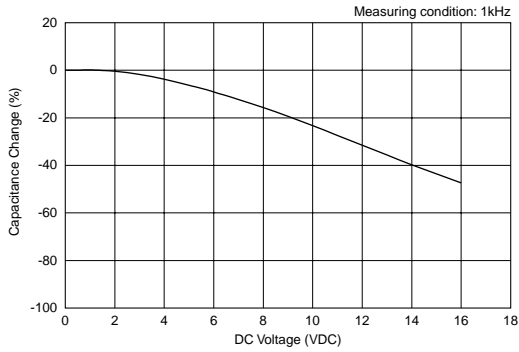

High Dielectric Constant Type: GRM155R61A105KE15

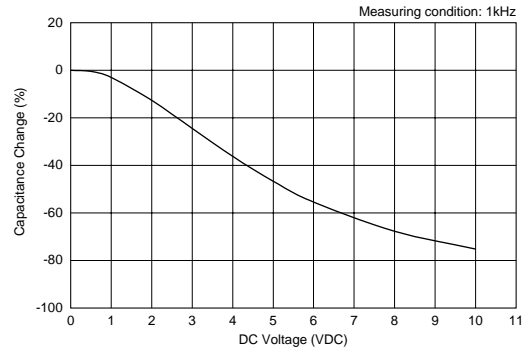

High Dielectric Constant Type: GRM188R60J106ME47

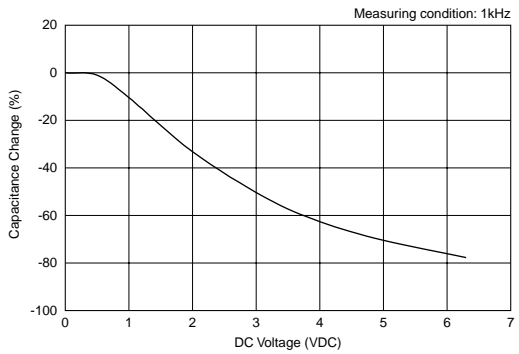

High Dielectric Constant Type: GRM31CR60J107ME39

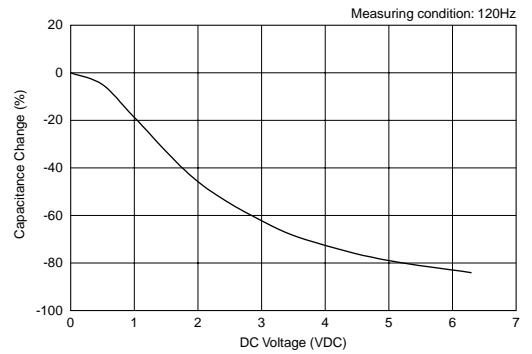

The data herein are given in typical values, not guaranteed ratings.
 Please refer to our Web site or contact our sales representatives for individual Part Number's data.
 Our Web Site: http://www.murata.com/products/capacitor/tech_data/

Continued on the following page.

For General
GRM Series

Array
GMM Series

Low ESL
LL Series

High-Q
GJM Series

High Frequency
GOM Series

Monolithic Microchip
GMA Series

For Bonding
GMD Series

Product Information

GRM Series Data

Continued from the preceding page.

Capacitance - AC Voltage Characteristics

Temperature Compensating Type: GRM1555C1H102JA01

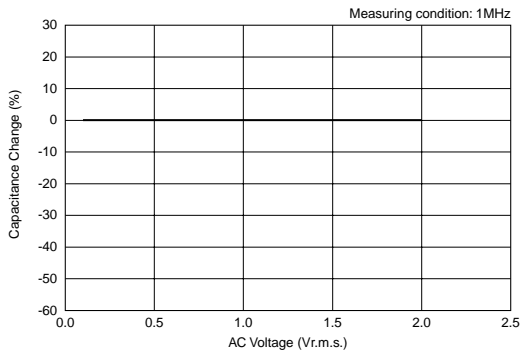

High Dielectric Constant Type: GRM155R71E103KA01

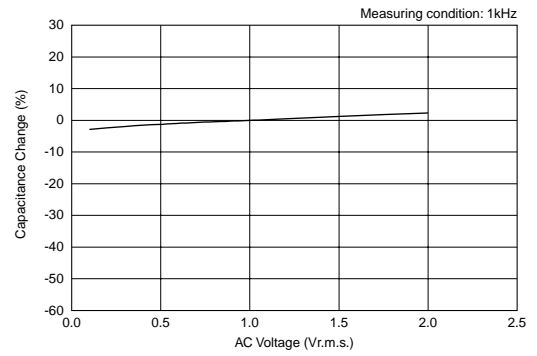

High Dielectric Constant Type: GRM155R71C104KA88

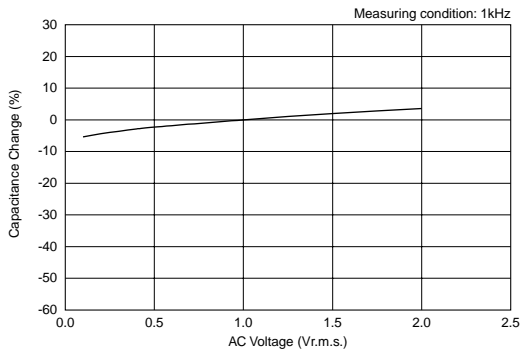

High Dielectric Constant Type: GRM155R61A105KE15

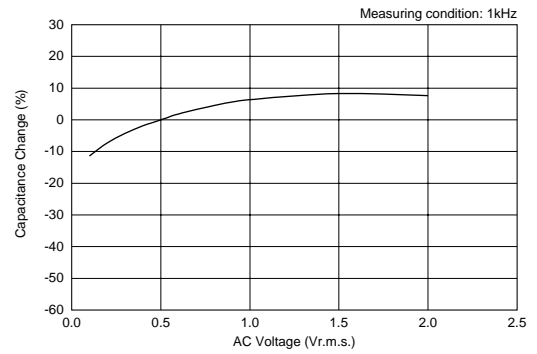

High Dielectric Constant Type: GRM188R60J106ME47

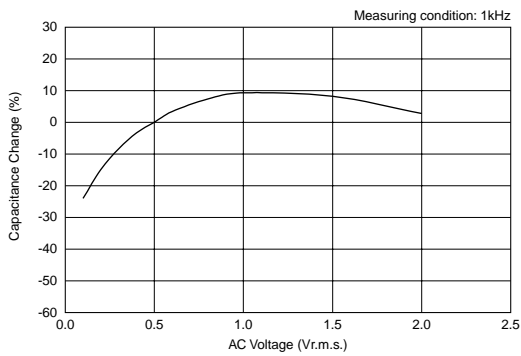

High Dielectric Constant Type: GRM31CR60J107ME39

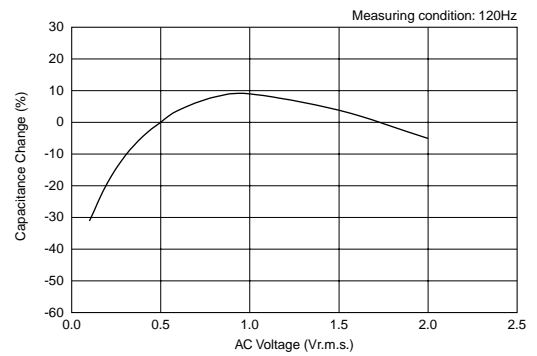

The data herein are given in typical values, not guaranteed ratings.
 Please refer to our Web site or contact our sales representatives for individual Part Number's data.
 Our Web Site: http://www.murata.com/products/capacitor/tech_data/

Chip Monolithic Ceramic Capacitors



Capacitor Array GNM Series

■ Features

1. High density mounting due to mounting space saving
2. Mounting cost saving

■ Applications

General electronic equipment

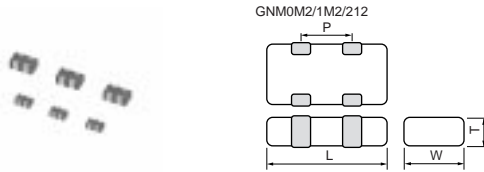

| Part Number | Dimensions (mm) | | | |
|---------------|-----------------|------------|-----------------|------------|
| | L | W | T | P |
| GNM0M2 | 0.9 ±0.05 | 0.6 ±0.05 | 0.45 ±0.05 | 0.45 ±0.05 |
| GNM1M2 | 1.37 ±0.15 | 1.0 ±0.15 | 0.5 +0.05/-0.10 | 0.64 ±0.05 |
| | | | 0.6 ±0.1 | |
| | | | 0.8 +0/-0.15 | |
| GNM212 | 2.0 ±0.15 | 1.25 ±0.15 | 0.6 ±0.1 | 1.0 ±0.1 |
| | | | 0.85 ±0.1 | |
| | | | 0.85 ±0.1 | |

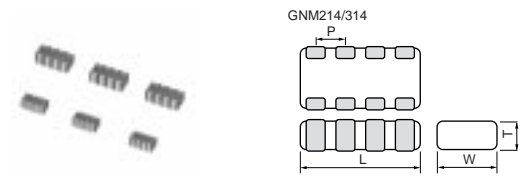

| Part Number | Dimensions (mm) | | | |
|---------------|-----------------|------------|----------------|-----------|
| | L | W | T | P |
| GNM214 | 2.0 ±0.15 | 1.25 ±0.15 | 0.5 +0.05/-0.1 | 0.5 ±0.05 |
| | | | 0.6 ±0.1 | |
| | | | 0.85 ±0.1 | |
| GNM314 | 3.2 ±0.15 | 1.6 ±0.15 | 0.8 ±0.1 | 0.8 ±0.1 |
| | | | 0.85 ±0.1 | |
| | | | 1.0 ±0.1 | |
| | | | 1.15 ±0.1 | |

For General
GRM Series

Array
GNM Series

Low ESL
LL□ Series

High-Q
GJM Series

High Frequency
GOM Series

Monolithic Microchip
GMA Series

For Bonding
GMD Series

Product Information

Capacitance Table

Temperature Compensating Type C0G(5C) Characteristics

| 0.6 | | ex.0.6: T Dimension [mm] | | | |
|---------------------|--------------------|----------------------------|----------------------------|---------------------------|------------|
| Capacitance | LxW [mm] | 1.37x1.0 (1M) <0504> | 2.0x1.25 (21) <0805> | 3.2x1.6 (31) <1206> | |
| | Number of Elements | 2(2) | | 4(4) | |
| Rated Voltage [Vdc] | | 50 (1H) | 50 (1H) | 100 (2A) | 50 (1H) |
| 10pF(100) | | 0.6 | 0.6 | 0.8 | 0.8 |
| 15pF(150) | | 0.6 | 0.6 | 0.8 | 0.8 |
| 22pF(220) | | 0.6 | 0.6 | 0.8 | 0.8 |
| 33pF(330) | | 0.6 | 0.6 | 0.8 | 0.8 |
| 47pF(470) | | 0.6 | 0.6 | 0.8 | 0.8 |
| 68pF(680) | | 0.6 | 0.6 | 0.8 | 0.8 |
| 100pF(101) | | 0.6 | 0.6 | 0.8 | 0.8 |
| 150pF(151) | | 0.6 | 0.6 | 0.8 | 0.8 |
| 220pF(221) | | 0.6 | 0.6 | | 0.8 |
| 330pF(331) | | | | | 0.8 |

The part number code is shown in () and Unit is shown in []. < >: EIA [inch] Code

High Dielectric Constant Type X7R(R7)/X7S(C7) Characteristics

| 0.6 | | ex.0.6: T Dimension [mm] | | | | | | | | | | | |
|---------------------|--------------------|----------------------------|------------|------------|------------|----------------------------|------------|------------|---------------------------|------------|------------|-------------|--|
| Capacitance | LxW [mm] | 1.37x1.0 (1M) <0504> | | | | 2.0x1.25 (21) <0805> | | | 3.2x1.6 (31) <1206> | | | | |
| | Number of Elements | 2(2) | | | | 4(4) | | | | | | | |
| Rated Voltage [Vdc] | | 50 (1H) | 25 (1E) | 16 (1C) | 10 (1A) | 50 (1H) | 25 (1E) | 16 (1C) | 50 (1H) | 25 (1E) | 16 (1C) | 6.3 (0J) | |
| 470pF(471) | | | | | | 0.6 | | | | | | | |
| 1000pF(102) | | 0.6 | | | | 0.6 | | | | | | | |
| 2200pF(222) | | | 0.6 | | | | 0.6 | | | | | | |
| 4700pF(472) | | | 0.6 | | | | 0.6 | | | | | | |
| 10000pF(103) | | | 0.6 | | | | 0.6 | | | | | | |
| 22000pF(223) | | | | 0.6 | 0.6 | | | 0.85 | | | | | |
| 47000pF(473) | | | | 0.6 | 0.6 | | | 0.85 | 0.85 | | 1.0 | | |
| 0.10μF(104) | | | | 0.6 | 0.6 | | | 0.85 | 0.85 | 0.85 | 1.0 | | |
| 1.0μF(105) | | | | | | | | | | | | 1.15 | |

The part number code is shown in () and Unit is shown in []. < >: EIA [inch] Code

High Dielectric Constant Type X7R(R7) Characteristics-Low Profile

| 0.5 | | ex.0.5: T Dimension [mm] | |
|---------------------|--------------------|----------------------------|----------------------------|
| Capacitance | LxW [mm] | 1.37x1.0 (1M) <0504> | 2.0x1.25 (21) <0805> |
| | Number of Elements | 2(2) | 4(4) |
| Rated Voltage [Vdc] | | 16 (1C) | 16 (1C) |
| 0.10μF(104) | | 0.5 | 0.5 |

The part number code is shown in () and Unit is shown in [].
< >: EIA [inch] Code

For General GRM Series

Array GNM Series

Low ESL LL□ Series

High-Q GJM Series

High Frequency GOM Series

Monolithic Microchip GMA Series

For Bonding GMD Series

Product Information

Capacitance Table

High Dielectric Constant Type X5R(R6) Characteristics

| 0.6 ex.0.6: T Dimension [mm] | | 0.9x0.6 (0M) <0302> | | | | 1.37x1.0 (1M) <0504> | | | | 2.0x1.25 (21) <0805> | | | 2.0x1.25 (21) <0805> | | 3.2x1.6 (31) <1206> | | | | | |
|-------------------------------------|--|---------------------------|------------|-------------|-----------|----------------------------|------------|------------|------------|----------------------------|------------|------------|----------------------------|------------|---------------------------|------------|------------|------|------|------|
| LxW [mm] | | | | | | | | | | | | | | | | | | | | |
| Number of Elements | | 2(2) | | | | | | | | | | 4(4) | | | | | | | | |
| Rated Voltage [Vdc] | | 16 (1C) | 10 (1A) | 6.3 (0J) | 4 (0G) | 50 (1H) | 25 (1E) | 16 (1C) | 10 (1A) | 6.3 (0J) | 16 (1C) | 10 (1A) | 6.3 (0J) | 10 (1A) | 6.3 (0J) | 16 (1C) | 10 (1A) | | | |
| Capacitance | | | | | | | | | | | | | | | | | | | | |
| 1000pF(102) | | | | | | 0.6 | | | | | | | | | | | | | | |
| 2200pF(222) | | | | | | | 0.6 | | | | | | | | | | | | | |
| 4700pF(472) | | | | | | | 0.6 | | | | | | | | | | | | | |
| 10000pF(103) | | 0.45 | 0.45 | 0.45 | | | | | 0.6 | | | | | | | | | | | |
| 22000pF(223) | | 0.45 | 0.45 | 0.45 | | | | | 0.6 | 0.6 | | | | | | | | | | |
| 47000pF(473) | | 0.45 | 0.45 | 0.45 | | | | | 0.6 | 0.6 | | | | | | | | | | |
| 0.10μF(104) | | 0.45 | 0.45 | 0.45 | | | | | | 0.6 | | | | | | | | | | |
| 0.22μF(224) | | | | | | | | | | 0.8 | | | | | | | | | | |
| 0.47μF(474) | | | | | | | | | | | | | 0.85 | | | | | | | |
| 1.0μF(105) | | | | | | 0.45 | | | | | 0.8 | 0.8 | 0.8 | 0.85 | 0.85 | | 0.85 | 0.85 | 0.85 | 0.85 |
| 2.2μF(225) | | | | | | | | | | | 0.8 | 0.8 | | 0.85 | 0.85 | | 0.85 | | | |

The part number code is shown in () and Unit is shown in []. < >: EIA [inch] Code

High Dielectric Constant Type X5R(R6) Characteristics-Low Profile

| 0.5 ex.0.5: T Dimension [mm] | | 1.37x1.0 (1M) <0504> | | 2.0x1.25 (21) <0805> |
|-------------------------------------|--|----------------------------|------------|----------------------------|
| LxW [mm] | | | | |
| Number of Elements | | 2(2) | | 4(4) |
| Rated Voltage [Vdc] | | 16 (1C) | 10 (1A) | 10 (1A) |
| Capacitance | | | | |
| 1.0μF(105) | | 0.5 | 0.5 | 0.5 |

The part number code is shown in () and Unit is shown in [].
< >: EIA [inch] Code

For General
GRM Series

Array
GNM Series

Low ESL
LL□ Series

High-Q
GJM Series

High Frequency
GQM Series

Monolithic Microchip
GMA Series

For Bonding
GMD Series

Product Information

Temperature Compensating Type C0G(5C) Characteristics

| LxW [mm] | | 1.37x1.0(1M)<0504> | | 2.0x1.25(21)<0805> | | 3.2x1.6(31)<1206> | |
|--------------------|-----------|--------------------|--------------------|--------------------|--------------------|-------------------|--------|
| Number of Elements | | 2(2) | | 4(4) | | | |
| Rated Volt. [Vdc] | | 50(1H) | | 50(1H) | | 100(2A) | 50(1H) |
| Capacitance | Tolerance | Part Number | | | | | |
| 10pF(100) | ±10%(K) | GNM1M25C1H100KD01D | GNM2145C1H100KD01D | GNM3145C2A100KD01D | GNM3145C1H100KD01D | | |
| 15pF(150) | ±10%(K) | GNM1M25C1H150KD01D | GNM2145C1H150KD01D | GNM3145C2A150KD01D | GNM3145C1H150KD01D | | |
| 22pF(220) | ±10%(K) | GNM1M25C1H220KD01D | GNM2145C1H220KD01D | GNM3145C2A220KD01D | GNM3145C1H220KD01D | | |
| 33pF(330) | ±10%(K) | GNM1M25C1H330KD01D | GNM2145C1H330KD01D | GNM3145C2A330KD01D | GNM3145C1H330KD01D | | |
| 47pF(470) | ±10%(K) | GNM1M25C1H470KD01D | GNM2145C1H470KD01D | GNM3145C2A470KD01D | GNM3145C1H470KD01D | | |
| 68pF(680) | ±10%(K) | GNM1M25C1H680KD01D | GNM2145C1H680KD01D | GNM3145C2A680KD01D | GNM3145C1H680KD01D | | |
| 100pF(101) | ±10%(K) | GNM1M25C1H101KD01D | GNM2145C1H101KD01D | GNM3145C2A101KD01D | GNM3145C1H101KD01D | | |
| 150pF(151) | ±10%(K) | GNM1M25C1H151KD01D | GNM2145C1H151KD01D | GNM3145C2A151KD01D | GNM3145C1H151KD01D | | |
| 220pF(221) | ±10%(K) | GNM1M25C1H221KD01D | GNM2145C1H221KD01D | | GNM3145C1H221KD01D | | |
| 330pF(331) | ±10%(K) | | | | GNM3145C1H331KD01D | | |

The part number code is shown in () and Unit is shown in []. < >: EIA [inch] Code

High Dielectric Constant Type X7R(R7)/X7S(C7) Characteristics

| LxW [mm] | | 1.37x1.0(1M)<0504> | | | | | |
|--------------------|-----------|--------------------|--|--------------------|--|--------------------|--------------------|
| Number of Elements | | 2(2) | | | | | |
| Rated Volt. [Vdc] | | 50(1H) | | 25(1E) | | 16(1C) | 10(1A) |
| Capacitance | Tolerance | Part Number | | | | | |
| 1000pF(102) | ±20%(M) | GNM1M2R71H102MA01D | | | | | |
| 2200pF(222) | ±20%(M) | | | GNM1M2R71E222MA01D | | | |
| 4700pF(472) | ±20%(M) | | | GNM1M2R71E472MA01D | | | |
| 10000pF(103) | ±20%(M) | | | GNM1M2R71E103MA01D | | | |
| 22000pF(223) | ±20%(M) | | | | | GNM1M2R71C223MA01D | GNM1M2R71A223MA01D |
| 47000pF(473) | ±20%(M) | | | | | GNM1M2R71C473MA01D | GNM1M2R71A473MA01D |
| 0.10μF(104) | ±20%(M) | | | | | GNM1M2R71C104MA01D | GNM1M2C71A104MA01D |

| LxW [mm] | | 2.0x1.25(21)<0805> | | | | | |
|--------------------|-----------|--------------------|--|--------------------|--|--------------------|--|
| Number of Elements | | 4(4) | | | | | |
| Rated Volt. [Vdc] | | 50(1H) | | 25(1E) | | 16(1C) | |
| Capacitance | Tolerance | Part Number | | | | | |
| 470pF(471) | ±20%(M) | GNM214R71H471MA01D | | | | | |
| 1000pF(102) | ±20%(M) | GNM214R71H102MA01D | | | | | |
| 2200pF(222) | ±20%(M) | | | GNM214R71E222MA01D | | | |
| 4700pF(472) | ±20%(M) | | | GNM214R71E472MA01D | | | |
| 10000pF(103) | ±20%(M) | | | GNM214R71E103MA01D | | | |
| 22000pF(223) | ±20%(M) | | | | | GNM214R71C223MA01D | |
| 47000pF(473) | ±20%(M) | | | | | GNM214R71C473MA01D | |
| 0.10μF(104) | ±20%(M) | | | | | GNM214R71C104MA01D | |

| LxW [mm] | | 3.2x1.6(31)<1206> | | | | | |
|--------------------|-----------|--------------------|--|--------------------|--|--------------------|---------|
| Number of Elements | | 4(4) | | | | | |
| Rated Volt. [Vdc] | | 50(1H) | | 25(1E) | | 16(1C) | 6.3(0J) |
| Capacitance | Tolerance | Part Number | | | | | |
| 47000pF(473) | ±20%(M) | GNM314R71H473MA11D | | | | GNM314R71C473MA01L | |
| 0.10μF(104) | ±20%(M) | GNM314R71H104MA11D | | GNM314R71E104MA11D | | GNM314R71C104MA01L | |
| 1.0μF(105) | ±20%(M) | | | | | GNM314R70J105MA01L | |

The part number code is shown in () and Unit is shown in []. < >: EIA [inch] Code

* Please refer to GNM series Specifications and Test Method (2).

(Part Number) **GN** **M** **1M** **2** **5C** **1H** **100** **K** **D01** **D** ①Product ID ②Series ③Dimensions (LxW) ④Number of Elements
 ⑤Temperature Characteristics ⑥Rated Voltage ⑦Capacitance
 ⑧Capacitance Tolerance ⑨Individual Specification Code ⑩Packaging

Packaging Code in Part Number shows STD 180mm Reel Taping.

For General GRM Series

High Dielectric Constant Type X7R(R7) Characteristics-Low Profile

| | | | | |
|--------------------|--------------------|--------------------|--------------------|--|
| LxW [mm] | 1.37x1.0(1M)<0504> | | 2.0x1.25(21)<0805> | |
| Number of Elements | 2(2) | | 4(4) | |
| Rated Volt. [Vdc] | 16(1C) | | 16(1C) | |
| Capacitance | Tolerance | Part Number | | |
| 0.10μF(104) | ±20%(M) | GNM1M2R71C104MAA1D | GNM214R71C104MAA1D | |

The part number code is shown in () and Unit is shown in []. < >: EIA [inch] Code

Array GNM Series

High Dielectric Constant Type X5R(R6) Characteristics

| | | | | |
|--------------------|-------------------|---------------------|---------------------|---------------------|
| LxW [mm] | 0.9x0.6(0M)<0302> | | | |
| Number of Elements | 2(2) | | | |
| Rated Volt. [Vdc] | 16(1C) | 10(1A) | 6.3(0J) | 4(0G) |
| Capacitance | Tolerance | Part Number | | |
| 10000pF(103) | ±20%(M) | GNM0M2R61C103ME18D* | GNM0M2R61A103ME17D* | GNM0M2R60J103ME17D* |
| 22000pF(223) | ±20%(M) | GNM0M2R61C223ME18D* | GNM0M2R61A223ME17D* | GNM0M2R60J223ME17D* |
| 47000pF(473) | ±20%(M) | GNM0M2R61C473ME18D* | GNM0M2R61A473ME17D* | GNM0M2R60J473ME17D* |
| 0.10μF(104) | ±20%(M) | GNM0M2R61C104ME18D* | GNM0M2R61A104ME17D* | GNM0M2R60J104ME17D* |
| 1.0μF(105) | ±20%(M) | | | GNM0M2R60G105ME17D* |

Low ESL LL□ Series

High-Q GJM Series

| | | | |
|--------------------|--------------------|--------------------|---------------------|
| LxW [mm] | 1.37x1.0(1M)<0504> | | |
| Number of Elements | 2(2) | | |
| Rated Volt. [Vdc] | 50(1H) | 25(1E) | 16(1C) |
| Capacitance | Tolerance | Part Number | |
| 1000pF(102) | ±20%(M) | GNM1M2R61H102MA01D | |
| 2200pF(222) | ±20%(M) | | GNM1M2R61E222MA01D |
| 4700pF(472) | ±20%(M) | | GNM1M2R61E472MA01D |
| 10000pF(103) | ±20%(M) | | GNM1M2R61E103MA01D |
| 22000pF(223) | ±20%(M) | | GNM1M2R61C223MA01D |
| 47000pF(473) | ±20%(M) | | GNM1M2R61C473MA01D |
| 0.22μF(224) | ±20%(M) | | GNM1M2R61C224ME18D* |
| 1.0μF(105) | ±20%(M) | | GNM1M2R61C105ME18D* |

High Frequency GQM Series

Monolithic Microchip GMA Series

| | | |
|--------------------|--------------------|---|
| LxW [mm] | 1.37x1.0(1M)<0504> | |
| Number of Elements | 2(2) | |
| Rated Volt. [Vdc] | 10(1A) | 6.3(0J) |
| Capacitance | Tolerance | Part Number |
| 22000pF(223) | ±20%(M) | GNM1M2R61A223MA01D |
| 47000pF(473) | ±20%(M) | GNM1M2R61A473MA01D |
| 0.10μF(104) | ±20%(M) | GNM1M2R61A104MA01D |
| 1.0μF(105) | ±20%(M) | GNM1M2R61A105ME17D* GNM1M2R60J105ME12D* |
| 2.2μF(225) | ±20%(M) | GNM1M2R61A225ME18D* GNM1M2R60J225ME18D* |

For Bonding GMD Series

| | | | |
|--------------------|--------------------|--------------------|---|
| LxW [mm] | 2.0x1.25(21)<0805> | | |
| Number of Elements | 2(2) | | |
| Rated Volt. [Vdc] | 16(1C) | 10(1A) | 6.3(0J) |
| Capacitance | Tolerance | Part Number | |
| 0.47μF(474) | ±20%(M) | GNM212R61C474MA16D | |
| 1.0μF(105) | ±20%(M) | GNM212R61C105MA16D | GNM212R61A105MA13D |
| 2.2μF(225) | ±20%(M) | | GNM212R61A225ME16D* GNM212R60J225ME16D* |

The part number code is shown in () and Unit is shown in []. < >: EIA [inch] Code

* Please refer to GNM series Specifications and Test Method (2).

Product Information

- (Part Number) **GN** **M** **1M** **2** **R7** **1C** **104** **M** **AA1** **D**
- ① Product ID
 - ② Series
 - ③ Dimensions (LxW)
 - ④ Number of Elements
 - ⑤ Temperature Characteristics
 - ⑥ Rated Voltage
 - ⑦ Capacitance
 - ⑧ Capacitance Tolerance
 - ⑨ Individual Specification Code
 - ⑩ Packaging

Packaging Code in Part Number shows STD 180mm Reel Taping.



High Dielectric Constant Type X5R(R6) Characteristics

| | | | |
|--------------------|-----------|---------------------|---------------------|
| LxW [mm] | | 2.0x1.25(21)<0805> | |
| Number of Elements | | 4(4) | |
| Rated Volt. [Vdc] | | 10(1A) | 6.3(0J) |
| Capacitance | Tolerance | Part Number | |
| 1.0μF(105) | ±20%(M) | GNM214R61A105ME17D* | GNM214R60J105ME17D* |
| 2.2μF(225) | ±20%(M) | | GNM214R60J225ME18D* |

| | | | |
|--------------------|-----------|--------------------|--------------------|
| LxW [mm] | | 3.2x1.6(31)<1206> | |
| Number of Elements | | 4(4) | |
| Rated Volt. [Vdc] | | 16(1C) | 10(1A) |
| Capacitance | Tolerance | Part Number | |
| 1.0μF(105) | ±20%(M) | GNM314R61C105MA15D | GNM314R61A105MA13D |

The part number code is shown in () and Unit is shown in []. < >: EIA [inch] Code

* Please refer to GNM series Specifications and Test Method (2).

High Dielectric Constant Type X5R(R6) Characteristics-Low Profile

| | | | |
|--------------------|-----------|---------------------|---|
| LxW [mm] | | 1.37x1.0(1M)<0504> | 2.0x1.25(21)<0805> |
| Number of Elements | | 2(2) | 4(4) |
| Rated Volt. [Vdc] | | 16(1C) | 10(1A) |
| Capacitance | Tolerance | Part Number | |
| 1.0μF(105) | ±20%(M) | GNM1M2R61C105MEA2D* | GNM1M2R61A105MEA4D* GNM214R61A105MEA2D* |

The part number code is shown in () and Unit is shown in []. < >: EIA [inch] Code

* Please refer to GNM series Specifications and Test Method (2).

For General
GRM Series

Array
GNM Series

Low ESL
LL□ Series

High-Q
GJM Series

High Frequency
GOM Series

Monolithic Microchip
GMA Series

For Bonding
GMD Series

Product Information

GNM Series Specifications and Test Methods (1)

When no "*" is added in PNs table, please refer to GNM Series Specifications and Test Methods (1).
 When "*" is added in PNs table, please refer to GNM Series Specifications and Test Methods (2).

| No. | Item | Specifications | | Test Method | | | | | | | | | | | | | | | | | | | | | | | | | |
|-------------------------|--|--|---|--|-----------------|-----------------|-------------|------|-----------------|------------|-------------|------------|----------------|---|-----------------|-------------|---|------|------------------|--------|-----------|----------|--------------------------------------|---------|--------------|-------------|-------------------------------------|-----|------|
| | | Temperature Compensating Type | High Dielectric Type | | | | | | | | | | | | | | | | | | | | | | | | | | |
| 1 | Operating Temperature Range | 5C: -55 to +125°C | R7, C7: -55 to +125°C R6: -55 to +85°C | | | | | | | | | | | | | | | | | | | | | | | | | | |
| 2 | Rated Voltage | See the previous pages. | | The rated voltage is defined as the maximum voltage that may be applied continuously to the capacitor. When AC voltage is superimposed on DC voltage, V^{P-P} or V^{O-P} , whichever is larger, should be maintained within the rated voltage range. | | | | | | | | | | | | | | | | | | | | | | | | | |
| 3 | Appearance | No defects or abnormalities | | Visual inspection | | | | | | | | | | | | | | | | | | | | | | | | | |
| 4 | Dimensions | Within the specified dimensions | | Using calipers | | | | | | | | | | | | | | | | | | | | | | | | | |
| 5 | Dielectric Strength | No defects or abnormalities | | No failure should be observed when 300% of the rated voltage (5C) or 250% of the rated voltage (R7) is applied between the terminations for 1 to 5 seconds, provided the charge/discharge current is less than 50mA. | | | | | | | | | | | | | | | | | | | | | | | | | |
| 6 | Insulation Resistance | More than 10,000MΩ or 500Ω · F (whichever is smaller) | | The insulation resistance should be measured with a DC voltage not exceeding the rated voltage at 25°C and 75%RH max. and within 2 minutes of charging. | | | | | | | | | | | | | | | | | | | | | | | | | |
| 7 | Capacitance | Within the specified tolerance | | The capacitance/Q/D.F. should be measured at 25°C at the frequency and voltage shown in the table. | | | | | | | | | | | | | | | | | | | | | | | | | |
| 8 | Q/ Dissipation Factor (D.F.) | 30pF min.: $Q \geq 1000$ 30pF max.: $Q \geq 400+20C$ C: Nominal Capacitance (pF) | <table border="1"> <thead> <tr> <th>Char.</th> <th>25V min.</th> <th>16V</th> <th>10V</th> <th>6.3V</th> </tr> </thead> <tbody> <tr> <td>R7, R6, C7</td> <td>0.025 max.</td> <td>0.035 max.</td> <td>0.035 max.</td> <td>0.05 max.</td> </tr> </tbody> </table> | Char. | 25V min. | 16V | 10V | 6.3V | R7, R6, C7 | 0.025 max. | 0.035 max. | 0.035 max. | 0.05 max. | <table border="1"> <thead> <tr> <th>Char.</th> <th>5C</th> <th>R7</th> </tr> </thead> <tbody> <tr> <td>Item</td> <td></td> <td></td> </tr> <tr> <td>Frequency</td> <td>1±0.1MHz</td> <td>1±0.1kHz</td> </tr> <tr> <td>Voltage</td> <td>0.5 to 5Vrms</td> <td>1.0±0.2Vrms</td> </tr> </tbody> </table> | Char. | 5C | R7 | Item | | | Frequency | 1±0.1MHz | 1±0.1kHz | Voltage | 0.5 to 5Vrms | 1.0±0.2Vrms | | | |
| | | | Char. | 25V min. | 16V | 10V | 6.3V | | | | | | | | | | | | | | | | | | | | | | |
| R7, R6, C7 | 0.025 max. | 0.035 max. | 0.035 max. | 0.05 max. | | | | | | | | | | | | | | | | | | | | | | | | | |
| Char. | 5C | R7 | | | | | | | | | | | | | | | | | | | | | | | | | | | |
| Item | | | | | | | | | | | | | | | | | | | | | | | | | | | | | |
| Frequency | 1±0.1MHz | 1±0.1kHz | | | | | | | | | | | | | | | | | | | | | | | | | | | |
| Voltage | 0.5 to 5Vrms | 1.0±0.2Vrms | | | | | | | | | | | | | | | | | | | | | | | | | | | |
| 9 | Capacitance Temperature Characteristics | Within the specified tolerance (Table A) | <table border="1"> <thead> <tr> <th>Char.</th> <th>Temp. Range</th> <th>Reference Temp.</th> <th>Cap. Change</th> </tr> </thead> <tbody> <tr> <td>R7</td> <td>-55°C to +125°C</td> <td rowspan="3">25°C</td> <td rowspan="2">Within ±15%</td> </tr> <tr> <td>R6</td> <td>-55°C to +85°C</td> </tr> <tr> <td>C7</td> <td>-55°C to +125°C</td> <td>Within ±22%</td> </tr> </tbody> </table> | Char. | Temp. Range | Reference Temp. | Cap. Change | R7 | -55°C to +125°C | 25°C | Within ±15% | R6 | -55°C to +85°C | C7 | -55°C to +125°C | Within ±22% | <p>The capacitance change should be measured after 5 min. at each specified temperature stage.</p> <p>(1) Temperature Compensating Type The temperature coefficient is determined using the capacitance measured in step 3 as a reference. When cycling the temperature sequentially from steps 1 through 5, the capacitance should be within the specified tolerance for the temperature coefficient and capacitance change as in Table A. The capacitance drift is calculated by dividing the differences between the maximum and minimum measured values in the steps 1, 3 and 5 by the cap. value in step 3.</p> <table border="1"> <thead> <tr> <th>Step</th> <th>Temperature (°C)</th> </tr> </thead> <tbody> <tr> <td>1</td> <td>25±2</td> </tr> <tr> <td>2</td> <td>-55±3 (for 5C/R7/C7), -30±3 (for F5)</td> </tr> <tr> <td>3</td> <td>25±2</td> </tr> <tr> <td>4</td> <td>125±3 (for 5C/R7/C7), 85±3 (for F5)</td> </tr> <tr> <td>5</td> <td>25±2</td> </tr> </tbody> </table> <p>(2) High Dielectric Constant Type The ranges of capacitance change compared with the above 25°C value over the temperature ranges shown in the table should be within the specified ranges.</p> <ul style="list-style-type: none"> Initial measurement for high dielectric constant type. Perform a heat treatment at 150+0/-10°C for one hour and then set for 24±2 hours at room temperature. Perform the initial measurement. | Step | Temperature (°C) | 1 | 25±2 | 2 | -55±3 (for 5C/R7/C7), -30±3 (for F5) | 3 | 25±2 | 4 | 125±3 (for 5C/R7/C7), 85±3 (for F5) | 5 | 25±2 |
| | | | Char. | Temp. Range | Reference Temp. | Cap. Change | | | | | | | | | | | | | | | | | | | | | | | |
| | | | R7 | -55°C to +125°C | 25°C | Within ±15% | | | | | | | | | | | | | | | | | | | | | | | |
| R6 | -55°C to +85°C | | | | | | | | | | | | | | | | | | | | | | | | | | | | |
| C7 | -55°C to +125°C | Within ±22% | | | | | | | | | | | | | | | | | | | | | | | | | | | |
| Step | Temperature (°C) | | | | | | | | | | | | | | | | | | | | | | | | | | | | |
| 1 | 25±2 | | | | | | | | | | | | | | | | | | | | | | | | | | | | |
| 2 | -55±3 (for 5C/R7/C7), -30±3 (for F5) | | | | | | | | | | | | | | | | | | | | | | | | | | | | |
| 3 | 25±2 | | | | | | | | | | | | | | | | | | | | | | | | | | | | |
| 4 | 125±3 (for 5C/R7/C7), 85±3 (for F5) | | | | | | | | | | | | | | | | | | | | | | | | | | | | |
| 5 | 25±2 | | | | | | | | | | | | | | | | | | | | | | | | | | | | |
| Capacitance Change | Within the specified tolerance (Table A) | | | | | | | | | | | | | | | | | | | | | | | | | | | | |
| Temperature Coefficient | Within the specified tolerance (Table A) | | | | | | | | | | | | | | | | | | | | | | | | | | | | |
| Capacitance Drift | Within ±0.2% or ±0.05pF (whichever is larger.) | | | | | | | | | | | | | | | | | | | | | | | | | | | | |
| 10 | Adhesive Strength of Termination | No removal of the terminations or other defect should occur. | | <p>Solder the capacitor to the test jig (glass epoxy board) shown in Fig.1 using a eutectic solder. Then apply 5N force in parallel with the test jig for 10±1 sec.</p> <p>The soldering should be done either with an iron or using the reflow method and should be conducted with care so that the soldering is uniform and free of defects such as heat shock.</p> <table border="1"> <thead> <tr> <th>Type</th> <th>a</th> <th>b</th> <th>c</th> <th>d</th> </tr> </thead> <tbody> <tr> <td>GNM1M2</td> <td>0.5</td> <td>1.6</td> <td>0.32</td> <td>0.32</td> </tr> <tr> <td>GNM212</td> <td>0.6</td> <td>1.8</td> <td>0.5</td> <td>0.5</td> </tr> <tr> <td>GNM214</td> <td>0.6</td> <td>2.0</td> <td>0.25</td> <td>0.25</td> </tr> <tr> <td>GNM314</td> <td>0.8</td> <td>2.5</td> <td>0.4</td> <td>0.4</td> </tr> </tbody> </table> <p style="text-align: right;">(in mm)</p> <p style="text-align: center;">Fig. 1</p> | Type | a | b | c | d | GNM1M2 | 0.5 | 1.6 | 0.32 | 0.32 | GNM212 | 0.6 | 1.8 | 0.5 | 0.5 | GNM214 | 0.6 | 2.0 | 0.25 | 0.25 | GNM314 | 0.8 | 2.5 | 0.4 | 0.4 |
| | | Type | a | | b | c | d | | | | | | | | | | | | | | | | | | | | | | |
| GNM1M2 | 0.5 | 1.6 | 0.32 | 0.32 | | | | | | | | | | | | | | | | | | | | | | | | | |
| GNM212 | 0.6 | 1.8 | 0.5 | 0.5 | | | | | | | | | | | | | | | | | | | | | | | | | |
| GNM214 | 0.6 | 2.0 | 0.25 | 0.25 | | | | | | | | | | | | | | | | | | | | | | | | | |
| GNM314 | 0.8 | 2.5 | 0.4 | 0.4 | | | | | | | | | | | | | | | | | | | | | | | | | |
| | | | | | | | | | | | | | | | | | | | | | | | | | | | | | |

Continued on the following page.

GNM Series Specifications and Test Methods (1)

Continued from the preceding page.

When no "*" is added in PNs table, please refer to GNM Series Specifications and Test Methods (1).
 When "*" is added in PNs table, please refer to GNM Series Specifications and Test Methods (2).

| No. | Item | Specifications | | | | Test Method | | | | | | | | | | | | | | | | | | | | | | |
|---------------------|---|--|--|--------------------------------|-------------------|---|--|-----------|---|--------|----------|----------|-----------|-----------|--------|----------|----------|----------|----------|--------|----------|----------|----------|----------|--------|----------|----------|----------|
| | | Temperature Compensating Type | High Dielectric Type | | | | | | | | | | | | | | | | | | | | | | | | | |
| 11 | Vibration Resistance | Appearance | No defects or abnormalities | | | | Solder the capacitor to the test jig (glass epoxy board) in the same manner and under the same conditions as (10). The capacitor should be subjected to a simple harmonic motion having a total amplitude of 1.5mm, the frequency being varied uniformly between the approximate limits of 10 and 55Hz. The frequency range, from 10 to 55Hz and return to 10Hz, should be traversed in approximately 1 minute. This motion should be applied for a period of 2 hours in each of 3 mutually perpendicular directions (total of 6 hours). | | | | | | | | | | | | | | | | | | | | | |
| | | Capacitance | Within the specified tolerance | | | | | | | | | | | | | | | | | | | | | | | | | |
| Q/D.F. | 30pF min.: $Q \geq 1000$ 30pF max.: $Q \geq 400+20C$ C: Nominal Capacitance (pF) | Char. | 25V min. | 16V | 10V | 6.3V | | | | | | | | | | | | | | | | | | | | | | |
| | | R7, R6, C7 | 0.025 max. | 0.035 max. | 0.035 max. | 0.05 max. | | | | | | | | | | | | | | | | | | | | | | |
| 12 | Deflection | Appearance | No marking defects | | | | Solder the capacitor on the test jig (glass epoxy board) shown in Fig. 2 using a eutectic solder. Then apply a force in the direction shown in Fig. 3 for 5 ± 1 sec. The soldering should be done by the reflow method and should be conducted with care so that the soldering is uniform and free of defects such as heat shock. | | | | | | | | | | | | | | | | | | | | | |
| | | Capacitance Change | Within $\pm 5\%$ or $\pm 0.5\text{pF}$ (whichever is larger) | | Within $\pm 10\%$ | | | | | | | | | | | | | | | | | | | | | | | |
| | | | | | | | | | | | | | | | | | | | | | | | | | | | | |
| | | <table border="1"> <thead> <tr> <th>Type</th> <th>a</th> <th>b</th> <th>c</th> <th>d</th> </tr> </thead> <tbody> <tr> <td>GNM1M2</td> <td>2.0±0.05</td> <td>0.5±0.05</td> <td>0.32±0.05</td> <td>0.32±0.05</td> </tr> <tr> <td>GNM212</td> <td>2.0±0.05</td> <td>0.6±0.05</td> <td>0.5±0.05</td> <td>0.5±0.05</td> </tr> <tr> <td>GNM214</td> <td>2.0±0.05</td> <td>0.7±0.05</td> <td>0.3±0.05</td> <td>0.2±0.05</td> </tr> <tr> <td>GNM314</td> <td>2.5±0.05</td> <td>0.8±0.05</td> <td>0.4±0.05</td> <td>0.4±0.05</td> </tr> </tbody> </table> | | Type | a | b | | c | d | GNM1M2 | 2.0±0.05 | 0.5±0.05 | 0.32±0.05 | 0.32±0.05 | GNM212 | 2.0±0.05 | 0.6±0.05 | 0.5±0.05 | 0.5±0.05 | GNM214 | 2.0±0.05 | 0.7±0.05 | 0.3±0.05 | 0.2±0.05 | GNM314 | 2.5±0.05 | 0.8±0.05 | 0.4±0.05 |
| Type | a | b | c | d | | | | | | | | | | | | | | | | | | | | | | | | |
| GNM1M2 | 2.0±0.05 | 0.5±0.05 | 0.32±0.05 | 0.32±0.05 | | | | | | | | | | | | | | | | | | | | | | | | |
| GNM212 | 2.0±0.05 | 0.6±0.05 | 0.5±0.05 | 0.5±0.05 | | | | | | | | | | | | | | | | | | | | | | | | |
| GNM214 | 2.0±0.05 | 0.7±0.05 | 0.3±0.05 | 0.2±0.05 | | | | | | | | | | | | | | | | | | | | | | | | |
| GNM314 | 2.5±0.05 | 0.8±0.05 | 0.4±0.05 | 0.4±0.05 | | | | | | | | | | | | | | | | | | | | | | | | |
| 13 | Solderability of Termination | 75% of the terminations are to be soldered evenly and continuously. | | | | Immerse the capacitor in a solution of ethanol (JIS-K-8101) and rosin (JIS-K-5902) (25% rosin in weight proportion). Preheat at 80 to 120°C for 10 to 30 seconds. After preheating, immerse in eutectic solder solution for 2 ± 0.5 seconds at $230 \pm 5^\circ\text{C}$ or Sn-3.0Ag-0.5Cu solder solution for 2 ± 0.5 seconds at $245 \pm 5^\circ\text{C}$. | | | | | | | | | | | | | | | | | | | | | | |
| 14 | Resistance to Soldering Heat | The measured and observed characteristics should satisfy the specifications in the following table. | | | | Preheat the capacitor at 120 to 150°C for 1 minute. Immerse the capacitor in a eutectic solder or Sn-3.0Ag-0.5Cu solder solution at $270 \pm 5^\circ\text{C}$ for 10 ± 0.5 seconds. Let sit at room temperature for 24 ± 2 hours, then measure. • Initial measurement for high dielectric constant type Perform a heat treatment at $150+0/-10^\circ\text{C}$ for one hour and then let sit for 24 ± 2 hours at room temperature. Perform the initial measurement. | | | | | | | | | | | | | | | | | | | | | | |
| | Appearance | No marking defects | | | | | | | | | | | | | | | | | | | | | | | | | | |
| | Capacitance Change | Within $\pm 2.5\%$ or $\pm 0.25\text{pF}$ (whichever is larger) | | R7, R6, C7: Within $\pm 7.5\%$ | | | | | | | | | | | | | | | | | | | | | | | | |
| | Q/D.F. | 30pF min.: $Q \geq 1000$ 30pF max.: $Q \geq 400+20C$ C: Nominal Capacitance (pF) | Char. | 25V min. | 16V | | 10V | 6.3V | | | | | | | | | | | | | | | | | | | | |
| | | | R7, R6, C7 | 0.025 max. | 0.035 max. | | 0.035 max. | 0.05 max. | | | | | | | | | | | | | | | | | | | | |
| I.R. | More than $10,000\text{M}\Omega$ or $500\Omega \cdot \text{F}$ (whichever is smaller) | | | | | | | | | | | | | | | | | | | | | | | | | | | |
| Dielectric Strength | No failure | | | | | | | | | | | | | | | | | | | | | | | | | | | |

Continued on the following page. ↗

For General GRM Series

Array GNM Series

Low ESL LL□ Series

High-Q GJM Series

High Frequency GQM Series

Monolithic Microchip GMA Series

For Bonding GMD Series

Product Information

GNM Series Specifications and Test Methods (1)

Continued from the preceding page.

When no "***" is added in PNs table, please refer to GNM Series Specifications and Test Methods (1).
 When "***" is added in PNs table, please refer to GNM Series Specifications and Test Methods (2).

| No. | Item | Specifications | | | | Test Method | | | | | | | | | | | | | | | |
|---------------------|--|---|--|----------------------------|------------|--|------|------------|------------|------------|------------|------------|----------------------------|------------|----------------------------|------------|-------------|------|--------|------|--------|
| | | Temperature Compensating Type | High Dielectric Type | | | | | | | | | | | | | | | | | | |
| 15 | Temperature Cycle | The measured and observed characteristics should satisfy the specifications in the following table. | | | | Fix the capacitor to the supporting jig in the same manner and under the same conditions as (10). Perform the five cycles according to the four heat treatments listed in the following table. Let sit for 24±2 hours (temperature compensating type) or 48±4 hours (high dielectric constant type) at room temperature, then measure. <table border="1" style="margin-top: 10px;"> <thead> <tr> <th>Step</th> <th>1</th> <th>2</th> <th>3</th> <th>4</th> </tr> </thead> <tbody> <tr> <td>Temp. (°C)</td> <td>Min. Operating Temp. +0/-3</td> <td>Room Temp.</td> <td>Max. Operating Temp. +3/-0</td> <td>Room Temp.</td> </tr> <tr> <td>Time (min.)</td> <td>30±3</td> <td>2 to 3</td> <td>30±3</td> <td>2 to 3</td> </tr> </tbody> </table> <ul style="list-style-type: none"> • Initial measurement for high dielectric constant type Perform a heat treatment at 150+0/-10°C for one hour and then let sit for 24±2 hours at room temperature. Perform the initial measurement. | Step | 1 | 2 | 3 | 4 | Temp. (°C) | Min. Operating Temp. +0/-3 | Room Temp. | Max. Operating Temp. +3/-0 | Room Temp. | Time (min.) | 30±3 | 2 to 3 | 30±3 | 2 to 3 |
| | Step | 1 | 2 | 3 | 4 | | | | | | | | | | | | | | | | |
| | Temp. (°C) | Min. Operating Temp. +0/-3 | Room Temp. | Max. Operating Temp. +3/-0 | Room Temp. | | | | | | | | | | | | | | | | |
| | Time (min.) | 30±3 | 2 to 3 | 30±3 | 2 to 3 | | | | | | | | | | | | | | | | |
| | Appearance | No marking defects | | | | | | | | | | | | | | | | | | | |
| | Capacitance Change | Within ±2.5% or ±0.25pF (whichever is larger) | R7, R6, C7: Within ±7.5% | | | | | | | | | | | | | | | | | | |
| Q/D.F. | 30pF min.: Q≥1000 30pF max.: Q≥400+20C C: Nominal Capacitance (pF) | <table border="1" style="font-size: small;"> <thead> <tr> <th>Char.</th> <th>25V min.</th> <th>16V</th> <th>10V</th> <th>6.3V</th> </tr> </thead> <tbody> <tr> <td>R7, R6, C7</td> <td>0.025 max.</td> <td>0.035 max.</td> <td>0.035 max.</td> <td>0.05 max.</td> </tr> </tbody> </table> | Char. | 25V min. | 16V | 10V | 6.3V | R7, R6, C7 | 0.025 max. | 0.035 max. | 0.035 max. | 0.05 max. | | | | | | | | | |
| Char. | 25V min. | 16V | 10V | 6.3V | | | | | | | | | | | | | | | | | |
| R7, R6, C7 | 0.025 max. | 0.035 max. | 0.035 max. | 0.05 max. | | | | | | | | | | | | | | | | | |
| I.R. | More than 10,000MΩ or 500Ω · F (whichever is smaller) | | | | | | | | | | | | | | | | | | | | |
| Dielectric Strength | No failure | | | | | | | | | | | | | | | | | | | | |
| 16 | Humidity Steady State | The measured and observed characteristics should satisfy the specifications in the following table. | | | | Set the capacitor at 40±2°C and 90 to 95% humidity for 500±12 hours. Remove and let sit for 24±2 hours at room temperature, then measure. | | | | | | | | | | | | | | | |
| | Appearance | No marking defects | | | | | | | | | | | | | | | | | | | |
| | Capacitance Change | Within ±5% or ±0.5pF (whichever is larger) | R7, R6, C7: Within ±12.5% | | | | | | | | | | | | | | | | | | |
| | Q/D.F. | 30pF and over: Q≥350 10pF and over, 30pF and below: Q≥275+5C/2 10pF and below: Q≥200+10C C: Nominal Capacitance (pF) | <table border="1" style="font-size: small;"> <thead> <tr> <th>Char.</th> <th>25V min.</th> <th>16V</th> <th>10V/6.3V</th> </tr> </thead> <tbody> <tr> <td>R7, R6, C7</td> <td>0.05 max.</td> <td>0.05 max.</td> <td>0.05 max.</td> </tr> </tbody> </table> | Char. | 25V min. | | 16V | 10V/6.3V | R7, R6, C7 | 0.05 max. | 0.05 max. | 0.05 max. | | | | | | | | | |
| | Char. | 25V min. | 16V | 10V/6.3V | | | | | | | | | | | | | | | | | |
| R7, R6, C7 | 0.05 max. | 0.05 max. | 0.05 max. | | | | | | | | | | | | | | | | | | |
| I.R. | More than 1,000MΩ or 50Ω · F (whichever is smaller) | | | | | | | | | | | | | | | | | | | | |
| 17 | Humidity Load | The measured and observed characteristics should satisfy the specifications in the following table. | | | | Apply the rated voltage at 40±2°C and 90 to 95% humidity for 500±12 hours. Remove and let sit for 24±2 hours at room temperature, then measure. The charge/discharge current is less than 50mA. | | | | | | | | | | | | | | | |
| | Appearance | No marking defects | | | | | | | | | | | | | | | | | | | |
| | Capacitance Change | Within ±7.5% or ±0.75pF (whichever is larger) | R7, R6, C7: Within ±12.5% | | | | | | | | | | | | | | | | | | |
| | Q/D.F. | 30pF and over: Q≥200 30pF and below: Q≥100+10C/3 C: Nominal Capacitance (pF) | <table border="1" style="font-size: small;"> <thead> <tr> <th>Char.</th> <th>25V min.</th> <th>16V</th> <th>10V/6.3V</th> </tr> </thead> <tbody> <tr> <td>R7, R6, C7</td> <td>0.05 max.</td> <td>0.05 max.</td> <td>0.05 max.</td> </tr> </tbody> </table> | Char. | 25V min. | | 16V | 10V/6.3V | R7, R6, C7 | 0.05 max. | 0.05 max. | 0.05 max. | | | | | | | | | |
| | Char. | 25V min. | 16V | 10V/6.3V | | | | | | | | | | | | | | | | | |
| R7, R6, C7 | 0.05 max. | 0.05 max. | 0.05 max. | | | | | | | | | | | | | | | | | | |
| I.R. | More than 500MΩ or 25Ω · F (whichever is smaller) | | | | | | | | | | | | | | | | | | | | |

Continued on the following page.

For General GRM Series

Array GNM Series

Low ESL LL□ Series

High-Q GJM Series

High Frequency GQM Series

Monolithic Microchip GMA Series

For Bonding GMD Series

Product Information

GNM Series Specifications and Test Methods (1)

Continued from the preceding page.

**When no "*" is added in PNs table, please refer to GNM Series Specifications and Test Methods (1).
 When "*" is added in PNs table, please refer to GNM Series Specifications and Test Methods (2).**

| No. | Item | Specifications | | | | Test Method | | | | | | | | |
|------------|---|--|--|----------|----------|---|-----|----------|------------|-----------|-----------|-----------|--|--|
| | | Temperature Compensating Type | High Dielectric Type | | | | | | | | | | | |
| 18 | High Temperature Load | The measured and observed characteristics should satisfy the specifications in the following table. | | | | Apply 200% of the rated voltage for 1000±12 hours at the maximum operating temperature ±3°C. Let sit for 24±2 hours at room temperature, then measure. The charge/discharge current is less than 50mA. • Initial measurement for high dielectric constant type. Apply 200% of the rated DC voltage for one hour at the maximum operating temperature ±3°C. Remove and let sit for 24±2 hours at room temperature. Perform initial measurement. | | | | | | | | |
| | Appearance | No marking defects | | | | | | | | | | | | |
| | Capacitance Change | Within ±3% or ±0.3pF (whichever is larger) | R7, R6, C7: Within ±12.5% | | | | | | | | | | | |
| | Q/D.F. | 30pF and over: $Q \geq 350$ 10pF and over, 30pF and below: $Q \geq 275 + 5C/2$ 10pF and below: $Q \geq 200 + 10C$ C: Nominal Capacitance (pF) | <table border="1" style="font-size: small;"> <thead> <tr> <th>Char.</th> <th>25V min.</th> <th>16V</th> <th>10V/6.3V</th> </tr> </thead> <tbody> <tr> <td>R7, R6, C7</td> <td>0.04 max.</td> <td>0.05 max.</td> <td>0.05 max.</td> </tr> </tbody> </table> | Char. | 25V min. | | 16V | 10V/6.3V | R7, R6, C7 | 0.04 max. | 0.05 max. | 0.05 max. | | |
| | Char. | 25V min. | 16V | 10V/6.3V | | | | | | | | | | |
| R7, R6, C7 | 0.04 max. | 0.05 max. | 0.05 max. | | | | | | | | | | | |
| I.R. | More than 1,000MΩ or 50Ω · F (whichever is smaller) | | | | | | | | | | | | | |

Table A

| Char. | Nominal Values (ppm/°C) *1 | Capacitance Change from 25°C (%) | | | | | |
|-----------|----------------------------|----------------------------------|-------|-------|-------|-------|-------|
| | | -55°C | | -30°C | | -10°C | |
| | | Max. | Min. | Max. | Min. | Max. | Min. |
| 5C | 0±30 | 0.58 | -0.24 | 0.40 | -0.17 | 0.25 | -0.11 |

*1: Nominal values denote the temperature coefficient within a range of 25 to 125°C.

For General GRM Series

Array GNM Series

Low ESL LL□ Series

High-Q GJM Series

High Frequency GOM Series

Monolithic Microchip GMA Series

For Bonding GMD Series

Product Information

GNM Series Specifications and Test Methods (2)

When no "***" is added in PNs table, please refer to GNM Series Specifications and Test Methods (1).
 When "***" is added in PNs table, please refer to GNM Series Specifications and Test Methods (2).

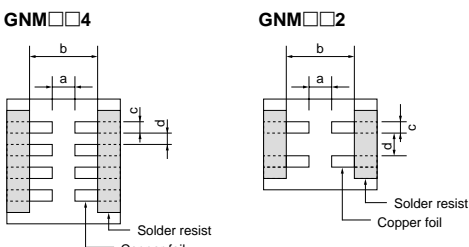
| No. | Item | Specifications | Test Method | | | | | | | | | | | | | | | | | | | | | | | | | | | | | | |
|---------------------------------|--|---|--|---------------------|---------------------|-----------------------------|--------------------------------|--------------------------------|-------------|---------------------------------|--|--|--|----------|-------------|-----------------------|--|-------------|--------|-----------|--------|-----------|------------|-----------|------------|-----------|----------------|-----------|--------|-----------|--------|-----|-----|
| 1 | Operating Temperature Range | R6: -55°C to +85°C | | | | | | | | | | | | | | | | | | | | | | | | | | | | | | | |
| 2 | Rated Voltage | See the previous pages. | The rated voltage is defined as the maximum voltage that may be applied continuously to the capacitor. When AC voltage is superimposed on DC voltage, V^{P-P} or V^{O-P} , whichever is larger, should be maintained within the rated voltage range. | | | | | | | | | | | | | | | | | | | | | | | | | | | | | | |
| 3 | Appearance | No defects or abnormalities | Visual inspection | | | | | | | | | | | | | | | | | | | | | | | | | | | | | | |
| 4 | Dimensions | Within the specified dimension | Using calipers | | | | | | | | | | | | | | | | | | | | | | | | | | | | | | |
| 5 | Dielectric Strength | No defects or abnormalities | No failure should be observed when 250% of the rated voltage is applied between the terminations for 1 to 5 seconds, provided the charge/discharge current is less than 50mA. | | | | | | | | | | | | | | | | | | | | | | | | | | | | | | |
| 6 | Insulation Resistance | 50Ω · F min. | The insulation resistance should be measured with a DC voltage not exceeding the rated voltage at 25°C and 75%RH max. and within 1 minute of charging. | | | | | | | | | | | | | | | | | | | | | | | | | | | | | | |
| 7 | Capacitance | Within the specified tolerance | The capacitance/D.F. should be measured at 25°C at the frequency and voltage shown in the table. <table border="1"> <thead> <tr> <th>Nominal Capacitance</th> <th>Measuring Frequency</th> <th>Measuring Voltage</th> </tr> </thead> <tbody> <tr> <td>$C \leq 10\mu F$ *1 (10V min.)</td> <td>1±0.1kHz</td> <td>1.0±0.2Vrms</td> </tr> <tr> <td>$C \leq 10\mu F$ *2 (6.3V max.)</td> <td>1±0.1kHz</td> <td>0.5±0.1Vrms</td> </tr> <tr> <td>*1For items in Table1</td> <td>1±0.1kHz</td> <td>0.5±0.1Vrms</td> </tr> <tr> <td>*2For items in Table2</td> <td>1±0.1kHz</td> <td>1.0±0.1Vrms</td> </tr> </tbody> </table> | Nominal Capacitance | Measuring Frequency | Measuring Voltage | $C \leq 10\mu F$ *1 (10V min.) | 1±0.1kHz | 1.0±0.2Vrms | $C \leq 10\mu F$ *2 (6.3V max.) | 1±0.1kHz | 0.5±0.1Vrms | *1For items in Table1 | 1±0.1kHz | 0.5±0.1Vrms | *2For items in Table2 | 1±0.1kHz | 1.0±0.1Vrms | | | | | | | | | | | | | | | |
| Nominal Capacitance | Measuring Frequency | Measuring Voltage | | | | | | | | | | | | | | | | | | | | | | | | | | | | | | | |
| $C \leq 10\mu F$ *1 (10V min.) | 1±0.1kHz | 1.0±0.2Vrms | | | | | | | | | | | | | | | | | | | | | | | | | | | | | | | |
| $C \leq 10\mu F$ *2 (6.3V max.) | 1±0.1kHz | 0.5±0.1Vrms | | | | | | | | | | | | | | | | | | | | | | | | | | | | | | | |
| *1For items in Table1 | 1±0.1kHz | 0.5±0.1Vrms | | | | | | | | | | | | | | | | | | | | | | | | | | | | | | | |
| *2For items in Table2 | 1±0.1kHz | 1.0±0.1Vrms | | | | | | | | | | | | | | | | | | | | | | | | | | | | | | | |
| 8 | Dissipation Factor (D.F.) | 0.1 max.*3 <table border="1"> <caption>Table 3</caption> <thead> <tr> <th>GNM0M2 R6</th> <th>103/223/473/104</th> </tr> </thead> <tbody> <tr> <td>GNM1M2 R6</td> <td>0J 105/225</td> </tr> <tr> <td>GNM1M2 R6</td> <td>1A 105MEA4</td> </tr> <tr> <td>GNM1M2 R6</td> <td>1A 225</td> </tr> <tr> <td>GNM212 R6</td> <td>0J 225</td> </tr> <tr> <td>GNM212 R6</td> <td>1A 225</td> </tr> <tr> <td>GNM214 R6</td> <td>0J 225</td> </tr> </tbody> </table> *3 However 0.125 max. for Table 3 items. | GNM0M2 R6 | 103/223/473/104 | GNM1M2 R6 | 0J 105/225 | GNM1M2 R6 | 1A 105MEA4 | GNM1M2 R6 | 1A 225 | GNM212 R6 | 0J 225 | GNM212 R6 | 1A 225 | GNM214 R6 | 0J 225 | <table border="1"> <caption>Table 1</caption> <thead> <tr> <th>GNM0M2 R6</th> <th>1A 104</th> </tr> </thead> <tbody> <tr> <td>GNM0M2 R6</td> <td>1C 104</td> </tr> <tr> <td>GNM1M2 R6</td> <td>1A 105/225</td> </tr> <tr> <td>GNM1M2 R6</td> <td>1C 224/105</td> </tr> </tbody> </table> <table border="1"> <caption>Table 2</caption> <thead> <tr> <th>GNM0M2 R6</th> <th>0J 103/223/473</th> </tr> </thead> <tbody> <tr> <td>GNM212 R6</td> <td>0J 225</td> </tr> <tr> <td>GNM214 R6</td> <td>0J 105</td> </tr> </tbody> </table> | GNM0M2 R6 | 1A 104 | GNM0M2 R6 | 1C 104 | GNM1M2 R6 | 1A 105/225 | GNM1M2 R6 | 1C 224/105 | GNM0M2 R6 | 0J 103/223/473 | GNM212 R6 | 0J 225 | GNM214 R6 | 0J 105 | | |
| GNM0M2 R6 | 103/223/473/104 | | | | | | | | | | | | | | | | | | | | | | | | | | | | | | | | |
| GNM1M2 R6 | 0J 105/225 | | | | | | | | | | | | | | | | | | | | | | | | | | | | | | | | |
| GNM1M2 R6 | 1A 105MEA4 | | | | | | | | | | | | | | | | | | | | | | | | | | | | | | | | |
| GNM1M2 R6 | 1A 225 | | | | | | | | | | | | | | | | | | | | | | | | | | | | | | | | |
| GNM212 R6 | 0J 225 | | | | | | | | | | | | | | | | | | | | | | | | | | | | | | | | |
| GNM212 R6 | 1A 225 | | | | | | | | | | | | | | | | | | | | | | | | | | | | | | | | |
| GNM214 R6 | 0J 225 | | | | | | | | | | | | | | | | | | | | | | | | | | | | | | | | |
| GNM0M2 R6 | 1A 104 | | | | | | | | | | | | | | | | | | | | | | | | | | | | | | | | |
| GNM0M2 R6 | 1C 104 | | | | | | | | | | | | | | | | | | | | | | | | | | | | | | | | |
| GNM1M2 R6 | 1A 105/225 | | | | | | | | | | | | | | | | | | | | | | | | | | | | | | | | |
| GNM1M2 R6 | 1C 224/105 | | | | | | | | | | | | | | | | | | | | | | | | | | | | | | | | |
| GNM0M2 R6 | 0J 103/223/473 | | | | | | | | | | | | | | | | | | | | | | | | | | | | | | | | |
| GNM212 R6 | 0J 225 | | | | | | | | | | | | | | | | | | | | | | | | | | | | | | | | |
| GNM214 R6 | 0J 105 | | | | | | | | | | | | | | | | | | | | | | | | | | | | | | | | |
| 9 | Capacitance Temperature Characteristics | <table border="1"> <thead> <tr> <th>Char.</th> <th>Temp. Range</th> <th>Reference Temp.</th> <th>Cap. Change</th> </tr> </thead> <tbody> <tr> <td>R6</td> <td>-55 to +85°C</td> <td>25°C</td> <td>Within ±15%</td> </tr> </tbody> </table> | Char. | Temp. Range | Reference Temp. | Cap. Change | R6 | -55 to +85°C | 25°C | Within ±15% | The capacitance change should be measured after 5 min. at each specified temperature stage. <table border="1"> <thead> <tr> <th>Step</th> <th>Temperature (°C)</th> </tr> </thead> <tbody> <tr> <td>1</td> <td>25±2</td> </tr> <tr> <td>2</td> <td>-55±3</td> </tr> <tr> <td>3</td> <td>25±2</td> </tr> <tr> <td>4</td> <td>85±3</td> </tr> <tr> <td>5</td> <td>25±2</td> </tr> </tbody> </table> The ranges of capacitance change compared with the 25°C value over the temperature ranges shown in the table should be within the specified ranges. • Initial measurement for high dielectric constant type. Perform a heat treatment at 150+0/-10°C for one hour and then set for 24±2 hours at room temperature. Perform the initial measurement. | Step | Temperature (°C) | 1 | 25±2 | 2 | -55±3 | 3 | 25±2 | 4 | 85±3 | 5 | 25±2 | | | | | | | | | | |
| Char. | Temp. Range | Reference Temp. | Cap. Change | | | | | | | | | | | | | | | | | | | | | | | | | | | | | | |
| R6 | -55 to +85°C | 25°C | Within ±15% | | | | | | | | | | | | | | | | | | | | | | | | | | | | | | |
| Step | Temperature (°C) | | | | | | | | | | | | | | | | | | | | | | | | | | | | | | | | |
| 1 | 25±2 | | | | | | | | | | | | | | | | | | | | | | | | | | | | | | | | |
| 2 | -55±3 | | | | | | | | | | | | | | | | | | | | | | | | | | | | | | | | |
| 3 | 25±2 | | | | | | | | | | | | | | | | | | | | | | | | | | | | | | | | |
| 4 | 85±3 | | | | | | | | | | | | | | | | | | | | | | | | | | | | | | | | |
| 5 | 25±2 | | | | | | | | | | | | | | | | | | | | | | | | | | | | | | | | |
| 10 | Adhesive Strength of Termination | No removal of the terminations or other defects should occur.  Fig. 1 | Solder the capacitor to the test jig (glass epoxy board) shown in Fig. 1 using a eutectic solder. Then apply 5N (GNM0M2: 2N) force in parallel with the test jig for 10±1 sec. The soldering should be done either with an iron or using the reflow method and should be conducted with care so that the soldering is uniform and free of defects such as heat shock. <table border="1"> <thead> <tr> <th>Type</th> <th>a</th> <th>b</th> <th>c</th> <th>d</th> </tr> </thead> <tbody> <tr> <td>GNM0M2</td> <td>0.2</td> <td>0.96</td> <td>0.25</td> <td>0.2</td> </tr> <tr> <td>GNM1M2</td> <td>0.5</td> <td>1.6</td> <td>0.32</td> <td>0.32</td> </tr> <tr> <td>GNM212</td> <td>0.6</td> <td>1.8</td> <td>0.5</td> <td>0.5</td> </tr> <tr> <td>GNM214</td> <td>0.6</td> <td>2.0</td> <td>0.25</td> <td>0.25</td> </tr> <tr> <td>GNM314</td> <td>0.8</td> <td>2.5</td> <td>0.4</td> <td>0.4</td> </tr> </tbody> </table> (in mm) | Type | a | b | c | d | GNM0M2 | 0.2 | 0.96 | 0.25 | 0.2 | GNM1M2 | 0.5 | 1.6 | 0.32 | 0.32 | GNM212 | 0.6 | 1.8 | 0.5 | 0.5 | GNM214 | 0.6 | 2.0 | 0.25 | 0.25 | GNM314 | 0.8 | 2.5 | 0.4 | 0.4 |
| Type | a | b | c | d | | | | | | | | | | | | | | | | | | | | | | | | | | | | | |
| GNM0M2 | 0.2 | 0.96 | 0.25 | 0.2 | | | | | | | | | | | | | | | | | | | | | | | | | | | | | |
| GNM1M2 | 0.5 | 1.6 | 0.32 | 0.32 | | | | | | | | | | | | | | | | | | | | | | | | | | | | | |
| GNM212 | 0.6 | 1.8 | 0.5 | 0.5 | | | | | | | | | | | | | | | | | | | | | | | | | | | | | |
| GNM214 | 0.6 | 2.0 | 0.25 | 0.25 | | | | | | | | | | | | | | | | | | | | | | | | | | | | | |
| GNM314 | 0.8 | 2.5 | 0.4 | 0.4 | | | | | | | | | | | | | | | | | | | | | | | | | | | | | |
| 11 | Vibration | <table border="1"> <thead> <tr> <th>Appearance</th> <th>Specifications</th> </tr> </thead> <tbody> <tr> <td>Appearance</td> <td>No defects or abnormalities</td> </tr> <tr> <td>Capacitance</td> <td>Within the specified tolerance</td> </tr> </tbody> </table> <table border="1"> <thead> <tr> <th>D.F.</th> <th>Specifications</th> </tr> </thead> <tbody> <tr> <td>D.F.</td> <td>0.1 max.*3 *3 However 0.125 max. for Table 3 items.</td> </tr> </tbody> </table> | Appearance | Specifications | Appearance | No defects or abnormalities | Capacitance | Within the specified tolerance | D.F. | Specifications | D.F. | 0.1 max.*3 *3 However 0.125 max. for Table 3 items. | Solder the capacitor to the test jig (glass epoxy board) in the same manner and under the same conditions as (10). The capacitor should be subjected to a simple harmonic motion having a total amplitude of 1.5mm, the frequency being varied uniformly between the approximate limits of 10 and 55Hz. The frequency range, from 10 to 55Hz and return to 10Hz, should be traversed in approximately 1 minute. This motion should be applied for a period of 2 hours in each of 3 mutually perpendicular directions (total of 6 hours). | | | | | | | | | | | | | | | | | | | | |
| Appearance | Specifications | | | | | | | | | | | | | | | | | | | | | | | | | | | | | | | | |
| Appearance | No defects or abnormalities | | | | | | | | | | | | | | | | | | | | | | | | | | | | | | | | |
| Capacitance | Within the specified tolerance | | | | | | | | | | | | | | | | | | | | | | | | | | | | | | | | |
| D.F. | Specifications | | | | | | | | | | | | | | | | | | | | | | | | | | | | | | | | |
| D.F. | 0.1 max.*3 *3 However 0.125 max. for Table 3 items. | | | | | | | | | | | | | | | | | | | | | | | | | | | | | | | | |

Continued on the following page. 

GNM Series Specifications and Test Methods (2)

Continued from the preceding page.

When no "*" is added in PNs table, please refer to GNM Series Specifications and Test Methods (1).
 When "*" is added in PNs table, please refer to GNM Series Specifications and Test Methods (2).

| No. | Item | Specifications | Test Method | | | | | | | | | | | | | | | | | | | | | | | | | | | | | | |
|---------------|------------------------------|---|---|-----------|---|---|---|---------------|----------|----------|----------|-----------|---------------|----------|----------|-----------|-----------|---------------|----------|----------|----------|----------|---------------|----------|----------|----------|----------|---------------|----------|----------|----------|----------|---|
| 12 | Appearance | No marking defects | Solder the capacitor to the test jig (glass epoxy board) shown in Fig. 2 using a eutectic solder. Then apply a force in the direction shown in Fig. 3. The soldering should be done by the reflow method and should be conducted with care so that the soldering is uniform and free of defects such as heat shock. | | | | | | | | | | | | | | | | | | | | | | | | | | | | | | |
| | Capacitance Change | Within ±10% | | | | | | | | | | | | | | | | | | | | | | | | | | | | | | | |
| | Deflection | <div style="text-align: center;"> </div> <table border="1" style="margin: 10px auto; border-collapse: collapse; text-align: center;"> <thead> <tr> <th>Type</th> <th>a</th> <th>b</th> <th>c</th> <th>d</th> </tr> </thead> <tbody> <tr> <td>GNM0M2</td> <td>2.0±0.05</td> <td>0.2±0.05</td> <td>0.2±0.05</td> <td>0.25±0.05</td> </tr> <tr> <td>GNM1M2</td> <td>2.0±0.05</td> <td>0.5±0.05</td> <td>0.32±0.05</td> <td>0.32±0.05</td> </tr> <tr> <td>GNM212</td> <td>2.0±0.05</td> <td>0.6±0.05</td> <td>0.5±0.05</td> <td>0.5±0.05</td> </tr> <tr> <td>GNM214</td> <td>2.0±0.05</td> <td>0.7±0.05</td> <td>0.3±0.05</td> <td>0.2±0.05</td> </tr> <tr> <td>GNM314</td> <td>2.5±0.05</td> <td>0.8±0.05</td> <td>0.4±0.05</td> <td>0.4±0.05</td> </tr> </tbody> </table> <p style="text-align: center;">(in mm)</p> | Type | a | b | c | d | GNM0M2 | 2.0±0.05 | 0.2±0.05 | 0.2±0.05 | 0.25±0.05 | GNM1M2 | 2.0±0.05 | 0.5±0.05 | 0.32±0.05 | 0.32±0.05 | GNM212 | 2.0±0.05 | 0.6±0.05 | 0.5±0.05 | 0.5±0.05 | GNM214 | 2.0±0.05 | 0.7±0.05 | 0.3±0.05 | 0.2±0.05 | GNM314 | 2.5±0.05 | 0.8±0.05 | 0.4±0.05 | 0.4±0.05 | <p style="text-align: center;">Fig. 3</p> |
| Type | a | b | c | d | | | | | | | | | | | | | | | | | | | | | | | | | | | | | |
| GNM0M2 | 2.0±0.05 | 0.2±0.05 | 0.2±0.05 | 0.25±0.05 | | | | | | | | | | | | | | | | | | | | | | | | | | | | | |
| GNM1M2 | 2.0±0.05 | 0.5±0.05 | 0.32±0.05 | 0.32±0.05 | | | | | | | | | | | | | | | | | | | | | | | | | | | | | |
| GNM212 | 2.0±0.05 | 0.6±0.05 | 0.5±0.05 | 0.5±0.05 | | | | | | | | | | | | | | | | | | | | | | | | | | | | | |
| GNM214 | 2.0±0.05 | 0.7±0.05 | 0.3±0.05 | 0.2±0.05 | | | | | | | | | | | | | | | | | | | | | | | | | | | | | |
| GNM314 | 2.5±0.05 | 0.8±0.05 | 0.4±0.05 | 0.4±0.05 | | | | | | | | | | | | | | | | | | | | | | | | | | | | | |
| 13 | Solderability of Termination | 75% of the terminations are to be soldered evenly and continuously. | Immerse the capacitor in a solution of ethanol (JIS-K-8101) and rosin (JIS-K-5902) (25% rosin in weight proportion). Preheat at 80 to 120°C for 10 to 30 seconds. After preheating, immerse in eutectic solder solution for 2±0.5 seconds at 230±5°C or Sn-3.0Ag-0.5Cu solder solution for 2±0.5 seconds at 245±5°C. | | | | | | | | | | | | | | | | | | | | | | | | | | | | | | |
| 14 | Appearance | No marking defects | Preheat the capacitor at 120 to 150°C for 1 minute. Immerse the capacitor in a eutectic solder or Sn-3.0Ag-0.5Cu solder solution at 270±5°C for 10±0.5 seconds. Let sit at room temperature for 24±2 hours, then measure. • Initial measurement Perform a heat treatment at 150 +0/-10°C for one hour and then let sit for 24±2 hours at room temperature. Perform the initial measurement. | | | | | | | | | | | | | | | | | | | | | | | | | | | | | | |
| | Capacitance Change | R6*: Within ±7.5% ** GNM0M2R60G105: Within +15/-7.5% | | | | | | | | | | | | | | | | | | | | | | | | | | | | | | | |
| | D.F. | 0.1 max. *3 *3 However 0.125 max. for Table 3 items. | | | | | | | | | | | | | | | | | | | | | | | | | | | | | | | |
| | I.R. | 50Ω · F min. | | | | | | | | | | | | | | | | | | | | | | | | | | | | | | | |
| | Dielectric Strength | No failure | | | | | | | | | | | | | | | | | | | | | | | | | | | | | | | |
| 15 | Appearance | No marking defects | Fix the capacitor to the supporting jig in the same manner and under the same conditions as (10). Perform the five cycles according to the four heat treatments listed in the following table. Let sit for 24±2 hours at room temperature, then measure. | | | | | | | | | | | | | | | | | | | | | | | | | | | | | | |
| | Capacitance Change | R6*: Within ±12.5% *5 GNM0M2R60G105, GNM0M2R60J103/223/473/104, GNM0M2R61A103/223/473/104, GNM0M2R61C103/223/473/104, GNM1M2R61A105: Within ±15% | | | | | | | | | | | | | | | | | | | | | | | | | | | | | | | |
| | D.F. | 0.1 max. *3 *3 However 0.125 max. for Table 3 items. | | | | | | | | | | | | | | | | | | | | | | | | | | | | | | | |
| | I.R. | 50Ω · F min. | | | | | | | | | | | | | | | | | | | | | | | | | | | | | | | |
| | Dielectric Strength | No failure | | | | | | | | | | | | | | | | | | | | | | | | | | | | | | | |
| 16 | Appearance | No marking defects | Apply the rated voltage at 40±2°C and 90 to 95% humidity for 500±12 hours. The charge/discharge current is less than 50mA. • Initial measurement Perform a heat treatment at 150 +0/-10°C for one hour and then let sit for 24±2 hours at room temperature. Perform the initial measurement. • Measurement after test Perform a heat treatment at 150 +0/-10°C for one hour and then let sit for 24±2 hours at room temperature, then measure. | | | | | | | | | | | | | | | | | | | | | | | | | | | | | | |
| | Capacitance Change | R6: Within ±12.5% | | | | | | | | | | | | | | | | | | | | | | | | | | | | | | | |
| | D.F. | 0.2 max. | | | | | | | | | | | | | | | | | | | | | | | | | | | | | | | |
| | I.R. | 12.5Ω · F min. | | | | | | | | | | | | | | | | | | | | | | | | | | | | | | | |
| 17 | Appearance | No marking defects | Apply 150% (GNM1M2R61A225/1C105: 125% of the rated voltage) of the rated voltage for 1000±12 hours at the maximum operating temperature ±3°C. Let sit for 24±2 hours at room temperature, then measure. The charge/discharge current is less than 50mA. • Initial measurement Perform a heat treatment at 150 +0/-10°C for one hour and then let sit for 24±2 hours at room temperature. Perform the initial measurement. • Measurement after test Perform a heat treatment at 150 +0/-10°C for one hour and then let sit for 24±2 hours at room temperature, then measure. | | | | | | | | | | | | | | | | | | | | | | | | | | | | | | |
| | Capacitance Change | R6: Within ±12.5% | | | | | | | | | | | | | | | | | | | | | | | | | | | | | | | |
| | D.F. | 0.2 max. | | | | | | | | | | | | | | | | | | | | | | | | | | | | | | | |
| | I.R. | 25Ω · F min. | | | | | | | | | | | | | | | | | | | | | | | | | | | | | | | |

For General GRM Series

Array GNM Series

Low ESL LL□ Series

High-Q GJM Series

High Frequency GQM Series

Monolithic Microchip GMA Series

For Bonding GMD Series

Product Information

Chip Monolithic Ceramic Capacitors



Low ESL LLL/LLR/LLA/LLM Series

Reversed Geometry Low ESL Type

■ Features

1. Low ESL, good for noise reduction for high frequency
2. Small, high cap

■ Applications

Decoupling solution for "chip sets", such as Mobile/FPD TV

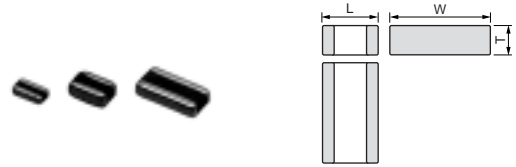

| Part Number | Dimensions (mm) | | |
|-------------|-----------------|-----------|----------------|
| | L | W | T |
| LLL153 | 0.5 ±0.05 | 1.0 ±0.05 | 0.3 ±0.05 |
| LLL185 | 0.8 ±0.1 | 1.6 ±0.1 | 0.6 max. |
| LLL215 | 1.25 ±0.1 | 2.0 ±0.1 | 0.5 +0/-0.15 |
| LLL216 | | | 0.6 ±0.1 |
| LLL219 | 1.6 ±0.15 | 3.2 ±0.15 | 0.85 ±0.1 |
| LLL315 | | | 0.5 +0/-0.15 |
| LLL317 | | | 0.7 ±0.1 |
| LLL31M | 0.8 ±0.15 | 1.6 ±0.15 | 1.15 ±0.1 |
| LLR185 | | | 0.5 +0.05/-0.1 |

Controlled ESR Low ESL Type

■ Features

1. Good solution for anti resonance reduction with Controlled ESR.
2. Suitable for high speed IC decoupling due to low inductance type.
3. 4 types of ESR are available.

■ Applications

1. All kind of IC package (network processor, media processor, etc)
2. Circuit that has anti-resonance

Eight Terminals Low ESL Type

■ Features

1. Low ESL (100pH), suitable to decoupling capacitor for 1GHz clock speed IC.
2. Small, high cap

■ Applications

High speed IC package (FPGA, network processor, etc)

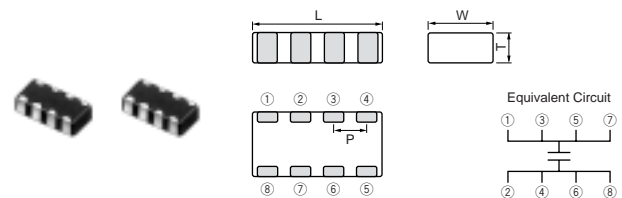

| Part Number | Dimensions (mm) | | | |
|-------------|-----------------|-----------|----------------|-----------|
| | L | W | T | P |
| LLA185 | 1.6 ±0.1 | 0.8 ±0.1 | 0.5 +0.05/-0.1 | 0.4 ±0.1 |
| LLA215 | 2.0 ±0.1 | 1.25 ±0.1 | 0.5 +0.05/-0.1 | 0.5 ±0.05 |
| LLA219 | 2.0 ±0.1 | 1.25 ±0.1 | 0.85 ±0.1 | 0.5 ±0.05 |
| LLA315 | 3.2 ±0.15 | 1.6 ±0.15 | 0.5 +0.05/-0.1 | 0.8 ±0.1 |
| LLA319 | 3.2 ±0.15 | 1.6 ±0.15 | 0.85 ±0.1 | 0.8 ±0.1 |
| LLA31M | 3.2 ±0.15 | 1.6 ±0.15 | 1.15 ±0.1 | 0.8 ±0.1 |

Ten Terminals Low ESL Type

■ Features

1. Low ESL (45pH), suitable to decoupling capacitor for 2GHz clock speed IC.
2. Small, high cap

■ Applications

High speed IC package (FPGA, network processor, etc)

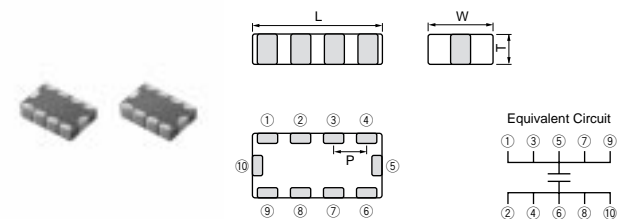

| Part Number | Dimensions (mm) | | | |
|-------------|-----------------|-----------|----------------|-----------|
| | L | W | T | P |
| LLM215 | 2.0 ±0.1 | 1.25 ±0.1 | 0.5 +0.05/-0.1 | 0.5 ±0.05 |
| LLM315 | 3.2 ±0.15 | 1.6 ±0.15 | 0.5 +0.05/-0.1 | 0.8 ±0.1 |

For General GRM Series

Array GNM Series

Low ESL LLL Series

High-Q GJM Series

High Frequency GOM Series

Monolithic Microchip GMA Series

For Bonding GMD Series

Product Information

Capacitance Table

Reversed Geometry Low ESL Type X7R(R7)/X7S(C7)/X6S(C8)/X5R(R6) Characteristics

| 5 | | ex.5: T Dimension [mm] | | | | | | | | | | | | | | | | | |
|--------------|----------|------------------------|----------|--------|---------|---------------------|---------|---------|--------|----------------------|---------|---------|---------|---------------------|---------|---------|---------|---------|----------|
| Capacitance | LxW [mm] | 0.5x1.0 (15) <0204> | | | | 0.8x1.6 (18) <0306> | | | | 1.25x2.0 (21) <0508> | | | | 1.6x3.2 (31) <0612> | | | | | |
| | | Rated Voltage [Vdc] | 6.3 (0J) | 4 (0G) | 50 (1H) | 25 (1E) | 16 (1C) | 10 (1A) | 4 (0G) | 50 (1H) | 25 (1E) | 16 (1C) | 10 (1A) | 4 (0G) | 50 (1H) | 25 (1E) | 16 (1C) | 10 (1A) | 6.3 (0J) |
| 2200pF(222) | | | | 5 | | | | | | | | | | | | | | | |
| 4700pF(472) | | | | 5 | | | | | | | | | | | | | | | |
| 10000pF(103) | | | | | 5 | | | | 6 | | | | | 7 | | | | | |
| 22000pF(223) | | | | | 5 | | | | 6 | | | | | 7 | | | | | |
| 47000pF(473) | | | | | | 5 | | | 6 | | | | | 7 | | | | | |
| 0.10μF(104) | | 3 | | | | | 5 | | 6 | | | | | M | 7 | | | | |
| 0.22μF(224) | | 3 | | | | | 5 | | | 9 | 6 | | | M | 7 | | | | |
| 0.47μF(474) | | | 3 | | | | | 5 | | | | 9 | | M | 7 | | | | |
| 1.0μF(105) | | | | | | | | 5 | | | | 9 | | | M | 7 | | | |
| 2.2μF(225) | | | | | | | | 5 | | | | | 9 | | | M | 7 | | |
| 4.7μF(475) | | | | | | | | | | | | | | | | | M | 7 | |
| 10μF(106) | | | | | | | | | | | | | | | | | | M | |

The part number code is shown in () and Unit is shown in []. <>: EIA [inch] Code

Reversed Geometry Low ESL Type X7R(R7)/X7S(C7) Characteristics-Low Profile

| 5 | | ex.5: T Dimension [mm] | | | | | | | | | | | | | | |
|--------------|----------|------------------------|---------|---------|---------|----------------------|---------|---------|---------|---------|---------------------|--------|---------|---------|---------|---------|
| Capacitance | LxW [mm] | 0.8x1.6 (18) <0306> | | | | 1.25x2.0 (21) <0508> | | | | | 1.6x3.2 (31) <0612> | | | | | |
| | | Rated Voltage [Vdc] | 25 (1E) | 16 (1C) | 10 (1A) | 4 (0G) | 50 (1H) | 25 (1E) | 16 (1C) | 10 (1A) | 6.3 (0J) | 4 (0G) | 50 (1H) | 25 (1E) | 16 (1C) | 10 (1A) |
| 10000pF(103) | | 5 | | | | 5 | | | | | | 5 | | | | |
| 22000pF(223) | | | 5 | | | | 5 | | | | | 5 | | | | |
| 47000pF(473) | | | 5 | | | | | 5 | | | | 5 | | | | |
| 0.10μF(104) | | | | 5 | | | | 5 | | | | 5 | | | | |
| 0.22μF(224) | | | | | 5 | | | | 5 | | | | 5 | | | |
| 0.47μF(474) | | | | | | | | | | 5 | | | | 5 | | |
| 1.0μF(105) | | | | | | | | | | | 5 | | | | | |

The part number code is shown in () and Unit is shown in []. <>: EIA [inch] Code

Controlled ESR Low ESL Type X7S(C7) Characteristics

| 5 | | ex.5: T Dimension [mm] | | | |
|-------------|----------|------------------------|-----------|-----------|------------|
| Capacitance | LxW [mm] | 0.8x1.6 (18) <0306> | | | |
| | | Rated Voltage [Vdc] | 4 (0G) | | |
| Capacitance | ESR [mΩ] | 100 (E01) | 220 (E03) | 470 (E05) | 1000 (E07) |
| | | 1.0μF(105) | | 5 | 5 |

The part number code is shown in () and Unit is shown in []. <>: EIA [inch] Code

For General GRM Series

Array GNM Series

Low ESL LL□ Series

High-Q GJM Series

High Frequency GOM Series

Monolithic Microchip GMA Series

For Bonding GMD Series

Product Information

Capacitance Table

For General
GRM Series

Eight Terminals Low ESL Type X7S(C7)/X7R(R7) Characteristics

| | | 5 ex.5: T Dimension [mm] | | | | | | | | | |
|--------------|--|---------------------------|------------|------------|----------------------------|-------------|-----------|------------|---------------------------|-----------|--|
| | | 1.6x0.8 (18) <0603> | | | 2.0x1.25 (21) <0805> | | | | 3.2x1.6 (31) <1206> | | |
| | | Rated Voltage [Vdc] | | | | | | | | | |
| Capacitance | | 4 (0G) | 25 (1E) | 16 (1C) | 10 (1A) | 6.3 (0J) | 4 (0G) | 16 (1C) | 10 (1A) | 4 (0G) | |
| 10000pF(103) | | | 9 | | | | | | | | |
| 22000pF(223) | | | 9 | | | | | | | | |
| 47000pF(473) | | | 9 | | | | | | | | |
| 0.10μF(104) | | 5 | | 9 | | | | 9 | | | |
| 0.22μF(224) | | 5 | | 9 | | | | 9 | | | |
| 0.47μF(474) | | 5 | | | 9 | | | 9 | | | |
| 1.0μF(105) | | 5 | | | | 9 | | M | 9 | | |
| 2.2μF(225) | | 5 | | | | | 9 | | M | 9 | |
| 4.7μF(475) | | | | | | | 9 | | | | |

The part number code is shown in () and Unit is shown in []. <->: EIA [inch] Code

Array
GMM Series

Low ESL
LL□ Series

Eight Terminals Low ESL Type X7R(R7)/X7S(C7) Characteristics-Low Profile

| | | 5 ex.5: T Dimension [mm] | | | | | | | | | |
|--------------|--|----------------------------|------------|------------|-------------|-----------|---------------------------|------------|-------------|--|--|
| | | 2.0x1.25 (21) <0805> | | | | | 3.2x1.6 (31) <1206> | | | | |
| | | Rated Voltage [Vdc] | | | | | | | | | |
| Capacitance | | 25 (1E) | 16 (1C) | 10 (1A) | 6.3 (0J) | 4 (0G) | 16 (1C) | 10 (1A) | 6.3 (0J) | | |
| 10000pF(103) | | 5 | | | | | | | | | |
| 22000pF(223) | | 5 | | | | | | | | | |
| 47000pF(473) | | | 5 | | | | | | | | |
| 0.10μF(104) | | | 5 | | | | | | | | |
| 0.22μF(224) | | | | 5 | | | 5 | | | | |
| 0.47μF(474) | | | | | 5 | | | 5 | | | |
| 1.0μF(105) | | | | | | 5 | | | 5 | | |
| 2.2μF(225) | | | | | | | 5 | | 5 | | |
| 4.7μF(475) | | | | | | | 5 | | | | |

The part number code is shown in () and Unit is shown in []. <->: EIA [inch] Code

High-Q
GJM Series

High Frequency
GOM Series

Ten Terminals Low ESL Type X7R(R7)/X7S(C7) Characteristics-Low Profile

| | | 5 ex.5: T Dimension [mm] | | | | | | | | | |
|--------------|--|----------------------------|------------|-------------|-----------|------------|---------------------------|-------------|--|--|--|
| | | 2.0x1.25 (21) <0805> | | | | | 3.2x1.6 (31) <1206> | | | | |
| | | Rated Voltage [Vdc] | | | | | | | | | |
| Capacitance | | 25 (1E) | 16 (1C) | 6.3 (0J) | 4 (0G) | 16 (1C) | 10 (1A) | 6.3 (0J) | | | |
| 10000pF(103) | | 5 | | | | | | | | | |
| 22000pF(223) | | 5 | | | | | | | | | |
| 47000pF(473) | | | 5 | | | | | | | | |
| 0.10μF(104) | | | 5 | | | 5 | | | | | |
| 0.22μF(224) | | | | 5 | | 5 | | | | | |
| 0.47μF(474) | | | | | 5 | | 5 | | | | |
| 1.0μF(105) | | | | | | 5 | | | | | |
| 2.2μF(225) | | | | | | | | 5 | | | |

The part number code is shown in () and Unit is shown in []. <->: EIA [inch] Code

Monolithic Microchip
GMA Series

For Bonding
GMD Series

Product Information

Reversed Geometry Low ESL Type X7R(R7)/X7S(C7)/X6S(C8) Characteristics

| | | | |
|-------------------|-----------|---------------------|-------|
| LxW [mm] | | 0.5x1.0(15)<0204> | |
| Rated Volt. [Vdc] | | 6.3(0J) | 4(0G) |
| Capacitance | Tolerance | Part Number | |
| 0.10μF(104) | ±20%(M) | LLL153C80J104ME01E* | |
| 0.22μF(224) | ±20%(M) | LLL153C80J224ME14E* | |
| 0.47μF(474) | ±20%(M) | LLL153C70G474ME17E* | |

LLL153 Series 4V/0.47μF(L: 0.5+0.07/-0.03mm)

| | | | | | |
|-------------------|-----------|--------------------|--------|--------|--------|
| LxW [mm] | | 0.8x1.6(18)<0306> | | | |
| Rated Volt. [Vdc] | | 50(1H) | 25(1E) | 16(1C) | 10(1A) |
| Capacitance | Tolerance | Part Number | | | |
| 2200pF(222) | ±20%(M) | LLL185R71H222MA01L | | | |
| 4700pF(472) | ±20%(M) | LLL185R71H472MA01L | | | |
| 10000pF(103) | ±20%(M) | LLL185R71E103MA01L | | | |
| 22000pF(223) | ±20%(M) | LLL185R71E223MA01L | | | |
| 47000pF(473) | ±20%(M) | LLL185R71C473MA01L | | | |
| 0.10μF(104) | ±20%(M) | LLL185R71A104MA01L | | | |
| 0.22μF(224) | ±20%(M) | LLL185R71A224MA01L | | | |

| | | | |
|-------------------|-----------|---------------------|--|
| LxW [mm] | | 0.8x1.6(18)<0306> | |
| Rated Volt. [Vdc] | | 4(0G) | |
| Capacitance | Tolerance | Part Number | |
| 0.47μF(474) | ±20%(M) | LLL185C70G474MA01L | |
| 1.0μF(105) | ±20%(M) | LLL185C70G105ME02L* | |
| 2.2μF(225) | ±20%(M) | LLL185C70G225ME01L* | |

| | | | | | |
|-------------------|-----------|--------------------|--------|--------|--------|
| LxW [mm] | | 1.25x2.0(21)<0508> | | | |
| Rated Volt. [Vdc] | | 50(1H) | 25(1E) | 16(1C) | 10(1A) |
| Capacitance | Tolerance | Part Number | | | |
| 10000pF(103) | ±20%(M) | LLL216R71H103MA01L | | | |
| 22000pF(223) | ±20%(M) | LLL216R71H223MA01L | | | |
| 47000pF(473) | ±20%(M) | LLL216R71E473MA01L | | | |
| 0.10μF(104) | ±20%(M) | LLL216R71E104MA01L | | | |
| 0.22μF(224) | ±20%(M) | LLL219R71C224MA01L | | | |
| 0.47μF(474) | ±20%(M) | LLL219R71A474MA01L | | | |
| 1.0μF(105) | ±20%(M) | LLL219R71A105MA01L | | | |

| | | | |
|-------------------|-----------|--------------------|--|
| LxW [mm] | | 1.25x2.0(21)<0508> | |
| Rated Volt. [Vdc] | | 4(0G) | |
| Capacitance | Tolerance | Part Number | |
| 2.2μF(225) | ±20%(M) | LLL219C70G225MA01L | |

The part number code is shown in () and Unit is shown in []. < >: EIA [inch] Code
 * Please refer to LLL/LLR/LLA/LLM Series Specifications and Test Method (2).

(Part Number) LL L 15 3 C8 0J 104 M E01 E

1 2 3 4 5 6 7 8 9 10

1 Product ID 2 Series 3 Dimensions (LxW) 4 Dimension (T)
5 Temperature Characteristics 6 Rated Voltage 7 Capacitance
8 Capacitance Tolerance 9 Individual Specification Code 10 Packaging

Packaging Code in Part Number shows STD 180mm Reel Taping.

For General GRM Series
 Array GNM Series
 Low ESL LLL Series
 High-Q GJM Series
 High Frequency GQM Series
 Monolithic Microchip GMA Series
 For Bonding GMD Series
 Product Information

Reversed Geometry Low ESL Type X7R(R7)/X5R(R6) Characteristics

| LxW [mm] | | 1.6x3.2(31)<0612> | | | |
|-------------------|-----------|--------------------|--------------------|--------------------|--------------------|
| Rated Volt. [Vdc] | | 50(1H) | 25(1E) | 16(1C) | 10(1A) |
| Capacitance | Tolerance | Part Number | | | |
| 10000pF(103) | ±20%(M) | LLL317R71H103MA01L | | | |
| 22000pF(223) | ±20%(M) | LLL317R71H223MA01L | | | |
| 47000pF(473) | ±20%(M) | LLL317R71H473MA01L | | | |
| 0.10μF(104) | ±20%(M) | LLL31MR71H104MA01L | LLL317R71E104MA01L | | |
| 0.22μF(224) | ±20%(M) | | LLL31MR71E224MA01L | LLL317R71C224MA01L | |
| 0.47μF(474) | ±20%(M) | | LLL31MR71E474MA01L | LLL317R71C474MA01L | |
| 1.0μF(105) | ±20%(M) | | | LLL31MR71C105MA01L | LLL317R71A105MA01L |
| 2.2μF(225) | ±20%(M) | | | | LLL31MR71A225MA01L |

| LxW [mm] | | 1.6x3.2(31)<0612> | |
|-------------------|-----------|---------------------|--|
| Rated Volt. [Vdc] | | 6.3(0J) | |
| Capacitance | Tolerance | Part Number | |
| 2.2μF(225) | ±20%(M) | LLL317R70J225MA01L | |
| 4.7μF(475) | ±20%(M) | LLL31MR70J475MA01L | |
| 10μF(106) | ±20%(M) | LLL31MR60J106ME01L* | |

The part number code is shown in () and Unit is shown in []. < >: EIA [inch] Code
 * Please refer to LLL/LLR/LLA/LLM Series Specifications and Test Method (2).

Reversed Geometry Low ESL Type X7R(R7)/X7S(C7) Characteristics-Low Profile

| LxW [mm] | | 0.8x1.6(18)<0306> | | | |
|-------------------|-----------|--------------------|--------------------|--------------------|--------------------|
| Rated Volt. [Vdc] | | 25(1E) | 16(1C) | 10(1A) | 4(0G) |
| Capacitance | Tolerance | Part Number | | | |
| 10000pF(103) | ±20%(M) | LLL185R71E103MA11L | | | |
| 22000pF(223) | ±20%(M) | | LLL185R71C223MA11L | | |
| 47000pF(473) | ±20%(M) | | LLL185R71C473MA11L | | |
| 0.10μF(104) | ±20%(M) | | | LLL185R71A104MA11L | |
| 0.22μF(224) | ±20%(M) | | | | LLL185C70G224MA11L |

| LxW [mm] | | 1.25x2.0(21)<0508> | | | |
|-------------------|-----------|--------------------|--------------------|--------------------|--------------------|
| Rated Volt. [Vdc] | | 50(1H) | 25(1E) | 16(1C) | 10(1A) |
| Capacitance | Tolerance | Part Number | | | |
| 10000pF(103) | ±20%(M) | LLL215R71H103MA11L | | | |
| 22000pF(223) | ±20%(M) | | LLL215R71E223MA11L | | |
| 47000pF(473) | ±20%(M) | | | LLL215R71C473MA11L | |
| 0.10μF(104) | ±20%(M) | | | LLL215R71C104MA11L | |
| 0.22μF(224) | ±20%(M) | | | | LLL215R71A224MA11L |

| LxW [mm] | | 1.25x2.0(21)<0508> | |
|-------------------|-----------|--------------------|-------|
| Rated Volt. [Vdc] | | 6.3(0J) | 4(0G) |
| Capacitance | Tolerance | Part Number | |
| 0.47μF(474) | ±20%(M) | LLL215R70J474MA11L | |
| 1.0μF(105) | ±20%(M) | LLL215C70G105MA11L | |

The part number code is shown in () and Unit is shown in []. < >: EIA [inch] Code

- (Part Number) **LL** **L** **31** **7** **R7** **1H** **103** **M** **A01** **L**
- ① Product ID
 - ② Series
 - ③ Dimensions (LxW)
 - ④ Dimension (T)
 - ⑤ Temperature Characteristics
 - ⑥ Rated Voltage
 - ⑦ Capacitance
 - ⑧ Capacitance Tolerance
 - ⑨ Individual Specification Code
 - ⑩ Packaging

Packaging Code in Part Number shows STD 180mm Reel Taping.

Reversed Geometry Low ESL Type X7R(R7) Characteristics-Low Profile

| LxW [mm] | | 1.6x3.2(31)<0612> | | | |
|-------------------|-----------|--------------------|--------------------|--------------------|--------------------|
| Rated Volt. [Vdc] | | 50(1H) | 25(1E) | 16(1C) | 10(1A) |
| Capacitance | Tolerance | Part Number | | | |
| 10000pF(103) | ±20%(M) | LLL315R71H103MA11L | | | |
| 22000pF(223) | ±20%(M) | LLL315R71H223MA11L | | | |
| 47000pF(473) | ±20%(M) | | LLL315R71E473MA11L | | |
| 0.10μF(104) | ±20%(M) | | LLL315R71E104MA11L | | |
| 0.22μF(224) | ±20%(M) | | | LLL315R71C224MA11L | |
| 0.47μF(474) | ±20%(M) | | | | LLL315R71A474MA11L |

The part number code is shown in () and Unit is shown in []. < >: EIA [inch] Code

Controlled ESR Low ESL Type X7S(C7) Characteristics

| LxW [mm] | | 0.8x1.6(18)<0306> | | | |
|-------------------|-----------|---------------------|---------------------|---------------------|---------------------|
| Rated Volt. [Vdc] | | 4(0G) | | | |
| ESR [mΩ] | | 100(E01) | 220(E03) | 470(E05) | 1000(E07) |
| Capacitance | Tolerance | Part Number | | | |
| 10000pF(103) | ±20%(M) | LLR185C70G105ME01L* | LLR185C70G105ME03L* | LLR185C70G105ME05L* | LLR185C70G105ME07L* |

The part number code is shown in () and Unit is shown in []. < >: EIA [inch] Code

* Please refer to LLL/LLR/LLA/LLM Series Specifications and Test Method (2).

Eight Terminals Low ESL Type X7R(R7)/X7S(C7) Characteristics

| LxW [mm] | | 1.6x0.8(18)<0603> | |
|-------------------|-----------|---------------------|--|
| Rated Volt. [Vdc] | | 4(0G) | |
| Capacitance | Tolerance | Part Number | |
| 0.10μF(104) | ±20%(M) | LLA185C70G104MA01L | |
| 0.22μF(224) | ±20%(M) | LLA185C70G224MA01L | |
| 0.47μF(474) | ±20%(M) | LLA185C70G474MA01L | |
| 1.0μF(105) | ±20%(M) | LLA185C70G105ME01L* | |
| 2.2μF(225) | ±20%(M) | LLA185C70G225ME16L* | |

| LxW [mm] | | 2.0x1.25(21)<0805> | | | |
|-------------------|-----------|--------------------|--------------------|--------------------|--------------------|
| Rated Volt. [Vdc] | | 25(1E) | 16(1C) | 10(1A) | 6.3(0J) |
| Capacitance | Tolerance | Part Number | | | |
| 10000pF(103) | ±20%(M) | LLA219R71E103MA01L | | | |
| 22000pF(223) | ±20%(M) | LLA219R71E223MA01L | | | |
| 47000pF(473) | ±20%(M) | LLA219R71E473MA01L | | | |
| 0.10μF(104) | ±20%(M) | | LLA219R71C104MA01L | | |
| 0.22μF(224) | ±20%(M) | | LLA219R71C224MA01L | | |
| 0.47μF(474) | ±20%(M) | | | LLA219R71A474MA01L | |
| 1.0μF(105) | ±20%(M) | | | | LLA219R70J105MA01L |

| LxW [mm] | | 2.0x1.25(21)<0805> | |
|-------------------|-----------|---------------------|--|
| Rated Volt. [Vdc] | | 4(0G) | |
| Capacitance | Tolerance | Part Number | |
| 2.2μF(225) | ±20%(M) | LLA219C70G225MA01L | |
| 4.7μF(475) | ±20%(M) | LLA219C70G475ME01L* | |

The part number code is shown in () and Unit is shown in []. < >: EIA [inch] Code

* Please refer to LLL/LLR/LLA/LLM Series Specifications and Test Method (2).

For General GRM Series

Array GNM Series

Low ESL LLL Series

High-Q GJM Series

High Frequency GOM Series

Monolithic Microchip GMA Series

For Bonding GMD Series

Product Information

Eight Terminals Low ESL Type X7R(R7) Characteristics

| LxW [mm] | | 3.2x1.6(31)<1206> | | |
|-------------------|-----------|--------------------|--------------------|--------------------|
| Rated Volt. [Vdc] | | 16(1C) | 10(1A) | 4(0G) |
| Capacitance | Tolerance | Part Number | | |
| 0.10μF(104) | ±20%(M) | LLA319R71C104MA01L | | |
| 0.22μF(224) | ±20%(M) | LLA319R71C224MA01L | | |
| 0.47μF(474) | ±20%(M) | LLA319R71C474MA01L | | |
| 1.0μF(105) | ±20%(M) | LLA31MR71C105MA01L | LLA319R71A105MA01L | |
| 2.2μF(225) | ±20%(M) | | LLA31MR71A225MA01L | LLA319R70G225MA01L |

The part number code is shown in () and Unit is shown in []. < >: EIA [inch] Code

Eight Terminals Low ESL Type X7R(R7)/X7S(C7) Characteristics-Low Profile

| LxW [mm] | | 2.0x1.25(21)<0805> | | | |
|-------------------|-----------|--------------------|--------------------|--------------------|--------------------|
| Rated Volt. [Vdc] | | 25(1E) | 16(1C) | 10(1A) | 6.3(0J) |
| Capacitance | Tolerance | Part Number | | | |
| 10000pF(103) | ±20%(M) | LLA215R71E103MA14L | | | |
| 22000pF(223) | ±20%(M) | LLA215R71E223MA14L | | | |
| 47000pF(473) | ±20%(M) | | LLA215R71C473MA14L | | |
| 0.10μF(104) | ±20%(M) | | LLA215R71C104MA14L | | |
| 0.22μF(224) | ±20%(M) | | | LLA215R71A224MA14L | |
| 0.47μF(474) | ±20%(M) | | | | LLA215R70J474MA14L |

| LxW [mm] | | 2.0x1.25(21)<0805> | 3.2x1.6(31)<1206> | | |
|-------------------|-----------|---------------------|--------------------|--------------------|--------------------|
| Rated Volt. [Vdc] | | 4(0G) | 16(1C) | 10(1A) | 6.3(0J) |
| Capacitance | Tolerance | Part Number | | | |
| 0.22μF(224) | ±20%(M) | | LLA315R71C224MA14L | | |
| 0.47μF(474) | ±20%(M) | | | LLA315R71A474MA14L | |
| 1.0μF(105) | ±20%(M) | LLA215C70G105MA14L | | | LLA315R70J105MA14L |
| 2.2μF(225) | ±20%(M) | LLA215C70G225ME11L* | | | LLA315R70J225MA14L |
| 4.7μF(475) | ±20%(M) | LLA215C70G475ME19L* | | | |

Ten Terminals Low ESL Type X7R(R7)/X7S(C7) Characteristics-Low Profile

| LxW [mm] | | 2.0x1.25(21)<0805> | | | |
|-------------------|-----------|--------------------|--------------------|--------------------|---------------------|
| Rated Volt. [Vdc] | | 25(1E) | 16(1C) | 6.3(0J) | 4(0G) |
| Capacitance | Tolerance | Part Number | | | |
| 10000pF(103) | ±20%(M) | LLM215R71E103MA11L | | | |
| 22000pF(223) | ±20%(M) | LLM215R71E223MA11L | | | |
| 47000pF(473) | ±20%(M) | | LLM215R71C473MA11L | | |
| 0.10μF(104) | ±20%(M) | | LLM215R71C104MA11L | | |
| 0.22μF(224) | ±20%(M) | | | LLM215R70J224MA11L | |
| 0.47μF(474) | ±20%(M) | | | LLM215R70J474MA11L | |
| 1.0μF(105) | ±20%(M) | | | | LLM215C70G105MA11L |
| 2.2μF(225) | ±20%(M) | | | | LLM215C70G225ME11L* |

| LxW [mm] | | 3.2x1.6(31)<1206> | | |
|-------------------|-----------|--------------------|--------------------|--------------------|
| Rated Volt. [Vdc] | | 16(1C) | 10(1A) | 6.3(0J) |
| Capacitance | Tolerance | Part Number | | |
| 0.10μF(104) | ±20%(M) | LLM315R71C104MA11L | | |
| 0.22μF(224) | ±20%(M) | LLM315R71C224MA11L | | |
| 0.47μF(474) | ±20%(M) | | LLM315R71A474MA11L | |
| 2.2μF(225) | ±20%(M) | | | LLM315R70J225MA11L |

The part number code is shown in () and Unit is shown in []. < >: EIA [inch] Code

* Please refer to LLL/LLR/LLA/LLM Series Specifications and Test Method (2).

(Part Number) **LL** **A** **31** **9** **R7** **1C** **104** **M** **A01** **L** ①Product ID ②Series ③Dimensions (LxW) ④Dimension (T)
 ⑤Temperature Characteristics ⑥Rated Voltage ⑦Capacitance
 ⑧Capacitance Tolerance ⑨Individual Specification Code ⑩Packaging

Packaging Code in Part Number shows STD 180mm Reel Taping.

LLL/LLR/LLA/LLM Series Specifications and Test Methods (1)

When no "*" is added in PNs table, please refer to LLL/LLR/LLA/LLM Series Specifications and Test Methods (1).
 When "*" is added in PNs table, please refer to LLL/LLR/LLA/LLM Series Specifications and Test Methods (2).

| No. | Item | Specifications | Test Method | | | | | | | | | | | | | | | | | | | | | | | | |
|-------|---|---|--|------------------|-----------------|------------|----|-------------|------|-------------------|----|-------------|------|-------------------|--|------|------------------|---|------|---|-------|---|------|---|-------|---|------|
| 1 | Operating Temperature Range | R7, C7: -55 to +125°C | | | | | | | | | | | | | | | | | | | | | | | | | |
| 2 | Rated Voltage | See the previous pages. | The rated voltage is defined as the maximum voltage that may be applied continuously to the capacitor. When AC voltage is superimposed on DC voltage, V^{P-P} or V^{O-P} , whichever is larger, should be maintained within the rated voltage range. | | | | | | | | | | | | | | | | | | | | | | | | |
| 3 | Appearance | No defects or abnormalities | Visual inspection | | | | | | | | | | | | | | | | | | | | | | | | |
| 4 | Dimensions | Within the specified dimension | Using calipers | | | | | | | | | | | | | | | | | | | | | | | | |
| 5 | Dielectric Strength | No defects or abnormalities | No failure should be observed when 250% of the rated voltage is applied between the terminations for 1 to 5 seconds, provided the charge/discharge current is less than 50mA. | | | | | | | | | | | | | | | | | | | | | | | | |
| 6 | Insulation Resistance | $C \leq 0.047\mu\text{F}$: More than 10,000MΩ $C > 0.047\mu\text{F}$: More than $500\Omega \cdot \text{F}$ C: Normal Capacitance | The insulation resistance should be measured with a DC voltage not exceeding the rated voltage at 25°C and 75%RH max. and within 2 minutes of charging. | | | | | | | | | | | | | | | | | | | | | | | | |
| 7 | Capacitance | Within the specified tolerance | The capacitance/D.F. should be measured at 25°C at the frequency and voltage shown in the table. Frequency: $1 \pm 0.1\text{kHz}$ Voltage: $1 \pm 0.2\text{Vrms}$ *For LLA185C70G474, the capacitance should be measured using a voltage of $0.5 \pm 0.1\text{Vrms}$. | | | | | | | | | | | | | | | | | | | | | | | | |
| 8 | Dissipation Factor (D.F.) | W.V.: 25V min.; 0.025 max. W.V.: 16V/10V max.; 0.035 max. W.V.: 6.3V max.; 0.05 max. | | | | | | | | | | | | | | | | | | | | | | | | | |
| 9 | Capacitance Temperature Characteristics | <table border="1" style="margin-left: auto; margin-right: auto;"> <thead> <tr> <th>Char.</th> <th>Temp. Range (°C)</th> <th>Reference Temp.</th> <th>Cap.Change</th> </tr> </thead> <tbody> <tr> <td>R7</td> <td>-55 to +125</td> <td>25°C</td> <td>Within $\pm 15\%$</td> </tr> <tr> <td>C7</td> <td>-55 to +125</td> <td>25°C</td> <td>Within $\pm 22\%$</td> </tr> </tbody> </table> | Char. | Temp. Range (°C) | Reference Temp. | Cap.Change | R7 | -55 to +125 | 25°C | Within $\pm 15\%$ | C7 | -55 to +125 | 25°C | Within $\pm 22\%$ | <p>The capacitance change should be measured after 5 min. at each specified temperature stage.</p> <table border="1" style="margin-left: auto; margin-right: auto;"> <thead> <tr> <th>Step</th> <th>Temperature (°C)</th> </tr> </thead> <tbody> <tr> <td>1</td> <td>25±2</td> </tr> <tr> <td>2</td> <td>-55±3</td> </tr> <tr> <td>3</td> <td>25±2</td> </tr> <tr> <td>4</td> <td>125±3</td> </tr> <tr> <td>5</td> <td>25±2</td> </tr> </tbody> </table> <p>The ranges of capacitance change compared with the 25°C value over the temperature ranges shown in the table should be within the specified ranges.</p> <ul style="list-style-type: none"> Initial measurement. <p>Perform a heat treatment at $150 \pm 0 / -10^\circ\text{C}$ for one hour and then set for 24 ± 2 hours at room temperature. Perform the initial measurement.</p> | Step | Temperature (°C) | 1 | 25±2 | 2 | -55±3 | 3 | 25±2 | 4 | 125±3 | 5 | 25±2 |
| Char. | Temp. Range (°C) | Reference Temp. | Cap.Change | | | | | | | | | | | | | | | | | | | | | | | | |
| R7 | -55 to +125 | 25°C | Within $\pm 15\%$ | | | | | | | | | | | | | | | | | | | | | | | | |
| C7 | -55 to +125 | 25°C | Within $\pm 22\%$ | | | | | | | | | | | | | | | | | | | | | | | | |
| Step | Temperature (°C) | | | | | | | | | | | | | | | | | | | | | | | | | | |
| 1 | 25±2 | | | | | | | | | | | | | | | | | | | | | | | | | | |
| 2 | -55±3 | | | | | | | | | | | | | | | | | | | | | | | | | | |
| 3 | 25±2 | | | | | | | | | | | | | | | | | | | | | | | | | | |
| 4 | 125±3 | | | | | | | | | | | | | | | | | | | | | | | | | | |
| 5 | 25±2 | | | | | | | | | | | | | | | | | | | | | | | | | | |
| 10 | Adhesive Strength of Termination | No removal of the terminations or other defect should occur. | Solder the capacitor to the test jig (glass epoxy board) using a eutectic solder. Then apply 10N* force in parallel with the test jig for 10 ± 1 sec. The soldering should be done either with an iron or using the reflow method and should be conducted with care so that the soldering is uniform and free of defects such as heat shock. *5N (LLL18 and LLA/LLM Series) | | | | | | | | | | | | | | | | | | | | | | | | |
| 11 | Vibration Resistance | Appearance | Solder the capacitor to the test jig (glass epoxy board) in the same manner and under the same conditions as (10). The capacitor should be subjected to a simple harmonic motion having a total amplitude of 1.5mm, the frequency being varied uniformly between the approximate limits of 10 and 55Hz. The frequency range, from 10 to 55Hz and return to 10Hz, should be traversed in approximately 1 minute. This motion should be applied for a period of 2 hours in each of 3 mutually perpendicular directions (total of 6 hours). | | | | | | | | | | | | | | | | | | | | | | | | |
| | | Capacitance | | | | | | | | | | | | | | | | | | | | | | | | | |
| | | D.F. | | | | | | | | | | | | | | | | | | | | | | | | | |
| 12 | Solderability of Termination | 75% of the terminations are to be soldered evenly and continuously. | Immerse the capacitor in a solution of ethanol (JIS-K-8101) and rosin (JIS-K-5902) (25% rosin in weight proportion). Preheat at 80 to 120°C for 10 to 30 seconds. After preheating, immerse in eutectic solder solution for 2 ± 0.5 seconds at $230 \pm 5^\circ\text{C}$, or Sn-3.0Ag-0.5Cu solder solution for 2 ± 0.5 seconds at $245 \pm 5^\circ\text{C}$. | | | | | | | | | | | | | | | | | | | | | | | | |
| 13 | Resistance to Soldering Heat | Appearance | Preheat the capacitor at 120 to 150°C for 1 minute. Immerse the capacitor in a eutectic solder or Sn-3.0Ag-0.5Cu solder solution at $270 \pm 5^\circ\text{C}$ for 10 ± 0.5 seconds. Let sit at room temperature for 24 ± 2 hours, then measure. | | | | | | | | | | | | | | | | | | | | | | | | |
| | | Capacitance Change | | | | | | | | | | | | | | | | | | | | | | | | | |
| | | D.F. | | | | | | | | | | | | | | | | | | | | | | | | | |
| | | I.R. | | | | | | | | | | | | | | | | | | | | | | | | | |
| | | Dielectric Strength | | | | | | | | | | | | | | | | | | | | | | | | | |

Continued on the following page.

LLL/LLR/LLA/LLM Series Specifications and Test Methods (1)

Continued from the preceding page. **When no "*" is added in PNs table, please refer to LLL/LLR/LLA/LLM Series Specifications and Test Methods (1). When "*" is added in PNs table, please refer to LLL/LLR/LLA/LLM Series Specifications and Test Methods (2).**

| No. | Item | Specifications | Test Method | | | | | | | | | | | | | | | |
|------|--|--------------------|---|--|------------|----------------------------|------------|---|------------|----------------------------|------------|----------------------------|------------|-------------|------|--------|------|--------|
| 14 | Temperature Cycle | Appearance | Fix the capacitor to the supporting jig in the same manner and under the same conditions as (10). Perform the five cycles according to the four heat treatments listed in the following table. Let sit for 24±2 hours at room temperature, then measure. <table border="1" style="margin-top: 10px;"> <thead> <tr> <th>Step</th> <th>1</th> <th>2</th> <th>3</th> <th>4</th> </tr> </thead> <tbody> <tr> <td>Temp. (°C)</td> <td>Min. Operating Temp. +0/-3</td> <td>Room Temp.</td> <td>Max. Operating Temp. +3/-0</td> <td>Room Temp.</td> </tr> <tr> <td>Time (min.)</td> <td>30±3</td> <td>2 to 3</td> <td>30±3</td> <td>2 to 3</td> </tr> </tbody> </table> | Step | 1 | 2 | 3 | 4 | Temp. (°C) | Min. Operating Temp. +0/-3 | Room Temp. | Max. Operating Temp. +3/-0 | Room Temp. | Time (min.) | 30±3 | 2 to 3 | 30±3 | 2 to 3 |
| | | Step | | 1 | 2 | 3 | 4 | | | | | | | | | | | |
| | | Temp. (°C) | | Min. Operating Temp. +0/-3 | Room Temp. | Max. Operating Temp. +3/-0 | Room Temp. | | | | | | | | | | | |
| | | Time (min.) | | 30±3 | 2 to 3 | 30±3 | 2 to 3 | | | | | | | | | | | |
| | | Capacitance Change | | Within ±7.5% | | | | | | | | | | | | | | |
| D.F. | W.V.: 25V min.; 0.025 max. W.V.: 16V/10V max.; 0.035 max. W.V.: 6.3V max.; 0.05 max. | | | | | | | | | | | | | | | | | |
| I.R. | More than 10,000MΩ or 500Ω · F (whichever is smaller) | | | | | | | | | | | | | | | | | |
| | Dielectric Strength | No failure | | | | | | | | | | | | | | | | |
| 15 | Humidity (Steady State) | Appearance | Set the capacitor at 40±2°C and 90 to 95% humidity for 500±12 hours. Remove and let sit for 24±2 hours at room temperature, then measure. | | | | | | | | | | | | | | | |
| | | Capacitance Change | | Within ±12.5% | | | | | | | | | | | | | | |
| | | D.F. | | W.V.: 10V min.; 0.05 max. W.V.: 6.3V max.; 0.075 max. | | | | | | | | | | | | | | |
| | | I.R. | | More than 1,000MΩ or 50Ω · F (whichever is smaller) | | | | | | | | | | | | | | |
| 16 | Humidity Load | Appearance | Apply the rated voltage at 40±2°C and 90 to 95% humidity for 500±12 hours. Remove and let sit for 24±2 hours at room temperature, then measure. The charge/discharge current is less than 50mA. | | | | | | | | | | | | | | | |
| | | Capacitance Change | | Within ±12.5% | | | | | | | | | | | | | | |
| | | D.F. | | W.V.: 10V min.; 0.05 max. W.V.: 6.3V max.; 0.075 max. | | | | | | | | | | | | | | |
| | | I.R. | | More than 500MΩ or 25Ω · F (whichever is smaller) | | | | | | | | | | | | | | |
| 17 | High Temperature Load | Appearance | Apply 200% of the rated voltage for 1000±12 hours at the maximum operating temperature ±3°C. Let sit for 24±2 hours at room temperature, then measure. The charge/discharge current is less than 50mA. <p>•Initial measurement. Apply 200% of the rated DC voltage for one hour at the maximum operating temperature ±3°C. Remove and let sit for 24±2 hours at room temperature. Perform initial measurement.</p> | | | | | | | | | | | | | | | |
| | | Capacitance Change | | Within ±12.5% | | | | | | | | | | | | | | |
| | | D.F. | | W.V.: 10V min.; 0.05 max. W.V.: 6.3V max.; 0.075 max. | | | | | | | | | | | | | | |
| | | I.R. | | More than 1,000MΩ or 50Ω · F (whichever is smaller) | | | | | | | | | | | | | | |

For General GRM Series

Array GNM Series

Low ESL LL□ Series

High-Q GJM Series

High Frequency GQM Series

Monolithic Microchip GMA Series

For Bonding GMD Series

Product Information

LLL/LLR/LLA/LLM Series Specifications and Test Methods (2)

When no "*" is added in PNs table, please refer to LLL/LLR/LLA/LLM Series Specifications and Test Methods (1).
 When "*" is added in PNs table, please refer to LLL/LLR/LLA/LLM Series Specifications and Test Methods (2).

| No. | Item | Specifications | Test Method | | | | | | | | | | | | | | | | | |
|---|---|---|--|------------------|-----------------|-------------|---------------------|------------|---------------|----------------------|------------|---------------|-------------|------------|---------------|-------------|----|-------------|-------------|--|
| 1 | Operating Temperature Range | R6: -55 to +85°C R7, C7: -55 to +125°C C8: -55 to +105°C | | | | | | | | | | | | | | | | | | |
| 2 | Rated Voltage | See the previous pages. | The rated voltage is defined as the maximum voltage that may be applied continuously to the capacitor. When AC voltage is superimposed on DC voltage, V^{P-P} or V^{0-P} , whichever is larger, should be maintained within the rated voltage range. | | | | | | | | | | | | | | | | | |
| 3 | Appearance | No defects or abnormalities | Visual inspection | | | | | | | | | | | | | | | | | |
| 4 | Dimensions | Within the specified dimension | Using calipers | | | | | | | | | | | | | | | | | |
| 5 | Dielectric Strength | No defects or abnormalities | No failure should be observed when 250% of the rated voltage is applied between the terminations for 1 to 5 seconds, provided the charge/discharge current is less than 50mA. | | | | | | | | | | | | | | | | | |
| 6 | Insulation Resistance | 50Ω · F min. | The insulation resistance should be measured with a DC voltage not exceeding the rated voltage at 25°C and 75%RH max. and within 1 minute of charging. | | | | | | | | | | | | | | | | | |
| 7 | Capacitance | Within the specified tolerance | The capacitance/D.F. should be measured at 25°C at the frequency and voltage shown in the table. | | | | | | | | | | | | | | | | | |
| 8 | Dissipation Factor (D.F.) | R6, R7, C7, C8: 0.120 max. | <table border="1" style="width: 100%; text-align: center;"> <thead> <tr> <th>Capacitance</th> <th>Frequency</th> <th>Voltage</th> </tr> </thead> <tbody> <tr> <td>C ≤ 10μF (10V min.)</td> <td>1 ± 0.1kHz</td> <td>1.0 ± 0.2Vrms</td> </tr> <tr> <td>C ≤ 10μF (6.3V max.)</td> <td>1 ± 0.1kHz</td> <td>0.5 ± 0.1Vrms</td> </tr> <tr> <td>C > 10μF</td> <td>120 ± 24Hz</td> <td>0.5 ± 0.1Vrms</td> </tr> </tbody> </table> | Capacitance | Frequency | Voltage | C ≤ 10μF (10V min.) | 1 ± 0.1kHz | 1.0 ± 0.2Vrms | C ≤ 10μF (6.3V max.) | 1 ± 0.1kHz | 0.5 ± 0.1Vrms | C > 10μF | 120 ± 24Hz | 0.5 ± 0.1Vrms | | | | | |
| | | | Capacitance | Frequency | Voltage | | | | | | | | | | | | | | | |
| C ≤ 10μF (10V min.) | 1 ± 0.1kHz | 1.0 ± 0.2Vrms | | | | | | | | | | | | | | | | | | |
| C ≤ 10μF (6.3V max.) | 1 ± 0.1kHz | 0.5 ± 0.1Vrms | | | | | | | | | | | | | | | | | | |
| C > 10μF | 120 ± 24Hz | 0.5 ± 0.1Vrms | | | | | | | | | | | | | | | | | | |
| <p>The capacitance change should be measured after 5 min. at each specified temperature stage. The ranges of capacitance change compared with the 25°C value over the temperature ranges shown in the table should be within the specified ranges.</p> <p>• Initial measurement. Perform a heat treatment at 150+0/-10°C for one hour and then set for 24±2 hours at room temperature. Perform the initial measurement.</p> | | | | | | | | | | | | | | | | | | | | |
| 9 | Capacitance Temperature Characteristics | <table border="1" style="width: 100%; text-align: center;"> <thead> <tr> <th>Char.</th> <th>Temp. Range (°C)</th> <th>Reference Temp.</th> <th>Cap. Change</th> </tr> </thead> <tbody> <tr> <td>R6</td> <td>-55 to +85</td> <td rowspan="4">25°C</td> <td>Within ±15%</td> </tr> <tr> <td>R7</td> <td>-55 to +125</td> <td>Within ±15%</td> </tr> <tr> <td>C7</td> <td>-55 to +125</td> <td>Within ±22%</td> </tr> <tr> <td>C8</td> <td>-55 to +105</td> <td>Within ±22%</td> </tr> </tbody> </table> | Char. | Temp. Range (°C) | Reference Temp. | Cap. Change | R6 | -55 to +85 | 25°C | Within ±15% | R7 | -55 to +125 | Within ±15% | C7 | -55 to +125 | Within ±22% | C8 | -55 to +105 | Within ±22% | |
| Char. | Temp. Range (°C) | Reference Temp. | Cap. Change | | | | | | | | | | | | | | | | | |
| R6 | -55 to +85 | 25°C | Within ±15% | | | | | | | | | | | | | | | | | |
| R7 | -55 to +125 | | Within ±15% | | | | | | | | | | | | | | | | | |
| C7 | -55 to +125 | | Within ±22% | | | | | | | | | | | | | | | | | |
| C8 | -55 to +105 | | Within ±22% | | | | | | | | | | | | | | | | | |
| 10 | Adhesive Strength of Termination | No removal of the terminations or other defect should occur. | Solder the capacitor to the test jig (glass epoxy board) using a eutectic solder. Then apply 10N* force in parallel with the test jig for 10±1 sec. The soldering should be done either with an iron or using the reflow method and should be conducted with care so that the soldering is uniform and free of defects such as heat shock. *5N (LLL15, LLL18, LLR18, LLA, LLM Series) | | | | | | | | | | | | | | | | | |
| 11 | Vibration | Appearance | No defects or abnormalities | | | | | | | | | | | | | | | | | |
| | | Capacitance | Within the specified tolerance | | | | | | | | | | | | | | | | | |
| | | D.F. | R6, R7, C7, C8: 0.120 max. | | | | | | | | | | | | | | | | | |
| 12 | Solderability of Termination | 75% of the terminations are to be soldered evenly and continuously. | Immerse the capacitor in a solution of ethanol (JIS-K-8101) and rosin (JIS-K-5902) (25% rosin in weight proportion). Preheat at 80 to 120°C for 10 to 30 seconds. After preheating, immerse in eutectic solder solution for 2±0.5 seconds at 230±5°C, or Sn-3.0Ag-0.5Cu solder solution for 2±0.5 seconds at 245±5°C. | | | | | | | | | | | | | | | | | |
| 13 | Resistance to Soldering Heat | Appearance | No marking defects | | | | | | | | | | | | | | | | | |
| | | Capacitance Change | R6, R7, C7, C8: Within ±7.5% | | | | | | | | | | | | | | | | | |
| | | D.F. | R6, R7, C7, C8: 0.120 max. | | | | | | | | | | | | | | | | | |
| | | I.R. | 50Ω · F min. | | | | | | | | | | | | | | | | | |
| | | Dielectric Strength | No failure | | | | | | | | | | | | | | | | | |
| | | | Preheat the capacitor at 120 to 150°C for 1 minute. Immerse the capacitor in a eutectic solder or Sn-3.0Ag-0.5Cu solder solution at 270±5°C for 10±0.5 seconds. Let sit at room temperature for 24±2 hours, then measure. • Initial measurement. Perform a heat treatment at 150+0/-10°C for one hour and then let sit for 24±2 hours at room temperature. Perform the initial measurement. | | | | | | | | | | | | | | | | | |

Continued on the following page.

For General GRM Series

Array GNM Series

Low ESL LLL Series

High-Q GJM Series

High Frequency GOM Series

Monolithic Microchip GMA Series

For Bonding GMD Series

Product Information

LLL/LLR/LLA/LLM Series Specifications and Test Methods (2)

☐ Continued from the preceding page. **When no "*" is added in PNs table, please refer to LLL/LLR/LLA/LLM Series Specifications and Test Methods (1).
 When "*" is added in PNs table, please refer to LLL/LLR/LLA/LLM Series Specifications and Test Methods (2).**

| No. | Item | Specifications | Test Method | | | | | | | | | | | | | | | |
|---------------------|----------------------------|---|---|------------|----------------------------|------------|---|---|------------|----------------------------|------------|----------------------------|------------|-------------|------|--------|------|--------|
| 14 | Appearance | No marking defects | Fix the capacitor to the supporting jig in the same manner and under the same conditions as (10). Perform the five cycles according to the four heat treatments listed in the following table. Let sit for 24±2 hours at room temperature, then measure. <table border="1" style="margin-top: 10px;"> <thead> <tr> <th>Step</th> <th>1</th> <th>2</th> <th>3</th> <th>4</th> </tr> </thead> <tbody> <tr> <td>Temp. (°C)</td> <td>Min. Operating Temp. +0/-3</td> <td>Room Temp.</td> <td>Min. Operating Temp. +0/-3</td> <td>Room Temp.</td> </tr> <tr> <td>Time (min.)</td> <td>30±3</td> <td>2 to 3</td> <td>30±3</td> <td>2 to 3</td> </tr> </tbody> </table> <ul style="list-style-type: none"> • Initial measurement Perform a heat treatment at 150+0/-10°C for one hour and then let sit for 24±2 hours at room temperature. Perform the initial measurement. | Step | 1 | 2 | 3 | 4 | Temp. (°C) | Min. Operating Temp. +0/-3 | Room Temp. | Min. Operating Temp. +0/-3 | Room Temp. | Time (min.) | 30±3 | 2 to 3 | 30±3 | 2 to 3 |
| | Step | 1 | | 2 | 3 | 4 | | | | | | | | | | | | |
| | Temp. (°C) | Min. Operating Temp. +0/-3 | | Room Temp. | Min. Operating Temp. +0/-3 | Room Temp. | | | | | | | | | | | | |
| | Time (min.) | 30±3 | | 2 to 3 | 30±3 | 2 to 3 | | | | | | | | | | | | |
| | Capacitance Change | R6, R7, C7, C8: Within ±12.5% | | | | | | | | | | | | | | | | |
| D.F. | R6, R7, C7, C8: 0.120 max. | | | | | | | | | | | | | | | | | |
| I.R. | 50Ω · F min. | | | | | | | | | | | | | | | | | |
| Dielectric Strength | No failure | | | | | | | | | | | | | | | | | |
| 15 | Appearance | No marking defects | Apply the rated voltage at 40±2°C and 90 to 95% humidity for 500±12 hours. The charge/discharge current is less than 50mA. Apply the rated DC voltage. <ul style="list-style-type: none"> • Initial measurement Perform a heat treatment at 150+0/-10°C for one hour and then let sit for 24±2 hours at room temperature. Perform the initial measurement. • Measurement after test Perform a heat treatment at 150+0/-10°C for one hour and then let sit for 24±2 hours at room temperature, then measure. | | | | | | | | | | | | | | | |
| | Capacitance Change | R6, R7, C7, C8: Within ±12.5% | | | | | | | | | | | | | | | | |
| | D.F. | R6, R7, C7, C8: 0.2 max. | | | | | | | | | | | | | | | | |
| | I.R. | 12.5Ω · F min. | | | | | | | | | | | | | | | | |
| 16 | Appearance | No marking defects | Apply 150% of the rated voltage for 1000±12 hours at the maximum operating temperature ±3°C. The charge/discharge current is less than 50mA. <ul style="list-style-type: none"> • Initial measurement Perform a heat treatment at 150+0/-10°C for one hour and then let sit for 24±2 hours at room temperature. Perform the initial measurement. • Measurement after test Perform a heat treatment at 150+0/-10°C for one hour and then let sit for 24±2 hours at room temperature, then measure. | | | | | | | | | | | | | | | |
| | Capacitance Change | R6, R7, C7, C8: Within ±12.5% * LLL153C70G474: Within ±20% | | | | | | | | | | | | | | | | |
| | D.F. | R6, R7, C7, C8: 0.2 max. | | | | | | | | | | | | | | | | |
| | I.R. | 25Ω · F min. | | | | | | | | | | | | | | | | |
| * | ESR | Within below ESR value at Frequency: 10±0.1MHz 100mΩ: Within 70 to 130mΩ 220mΩ: Within 154 to 286mΩ 470mΩ: Within 329 to 611mΩ 1000mΩ: Within 700 to 1300mΩ | The ESR should be measured at room temperature with the Equivalent of HP4294A. | | | | | | | | | | | | | | | |

* LLR: This specification is only for LLR Type

For General GRM Series

Array GNM Series

Low ESL LL□ Series

High-Q GJM Series

High Frequency GOM Series

Monolithic Microchip GMA Series

For Bonding GMD Series

Product Information

Chip Monolithic Ceramic Capacitors



High-Q Type GJM Series

■ Features

1. Mobile Telecommunication and RF module, mainly
2. Improvement of telephone call quality, Low power Consumption, yield ratio improvement.

■ Applications

VCO, PA, Mobile Telecommunication

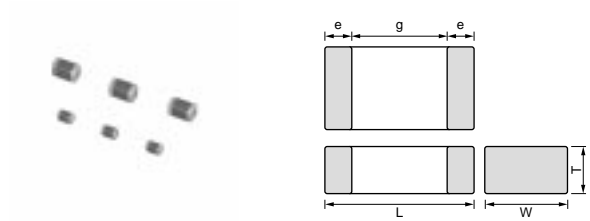

| Part Number | Dimensions (mm) | | | | |
|--------------|-----------------|-----------|-----------|--------------|--------|
| | L | W | T | e | g min. |
| GJM03 | 0.6 ±0.03 | 0.3 ±0.03 | 0.3 ±0.03 | 0.1 to 0.2 | 0.2 |
| GJM15 | 1.0 ±0.05 | 0.5 ±0.05 | 0.5 ±0.05 | 0.15 to 0.35 | 0.3 |

For General
GRM Series

Array
GMM Series

Low ESL
LL□ Series

High-Q
GJM Series

High Frequency
GOM Series

Monolithic Microchip
GMA Series

For Bonding
GMD Series

Product Information

Capacitance Table

Temperature Compensating Type C0G(5C)/C0H(6C) Characteristics

| | | 3 ex.3: T Dimension [mm] | | | | | | | | | | | | |
|-------------|----------|--------------------------|---------|---------------------|-------------|----------|---------------------|---------------------|---------------------|-------------|----------|---------------------|---------|---------------------|
| Capacitance | LxW [mm] | 0.6x0.3 (03) <0201> | | 1.0x0.5 (15) <0402> | Capacitance | LxW [mm] | 0.6x0.3 (03) <0201> | | 1.0x0.5 (15) <0402> | Capacitance | LxW [mm] | 0.6x0.3 (03) <0201> | | 1.0x0.5 (15) <0402> |
| | | Rated Voltage [Vdc] | 25 (1E) | 6.3 (0J) | | | 50 (1H) | Rated Voltage [Vdc] | 25 (1E) | | | 6.3 (0J) | 50 (1H) | Rated Voltage [Vdc] |
| 0.1pF(R10) | | | | 5 | 5.0pF(5R0) | | 3 | | 5 | 9.9pF(9R9) | | 3 | | 5 |
| 0.2pF(R20) | 3 | | | 5 | 5.1pF(5R1) | 3 | | | 5 | 10pF(100) | 3 | | | 5 |
| 0.3pF(R30) | 3 | | | 5 | 5.2pF(5R2) | 3 | | | 5 | 11pF(110) | 3 | | | 5 |
| 0.4pF(R40) | 3 | | | 5 | 5.3pF(5R3) | 3 | | | 5 | 12pF(120) | 3 | | | 5 |
| 0.5pF(R50) | 3 | | | 5 | 5.4pF(5R4) | 3 | | | 5 | 13pF(130) | 3 | | | 5 |
| 0.6pF(R60) | 3 | | | 5 | 5.5pF(5R5) | 3 | | | 5 | 15pF(150) | 3 | | | 5 |
| 0.7pF(R70) | 3 | | | 5 | 5.6pF(5R6) | 3 | | | 5 | 16pF(160) | 3 | | | 5 |
| 0.8pF(R80) | 3 | | | 5 | 5.7pF(5R7) | 3 | | | 5 | 18pF(180) | 3 | | | 5 |
| 0.9pF(R90) | 3 | | | 5 | 5.8pF(5R8) | 3 | | | 5 | 20pF(200) | 3 | | | 5 |
| 1.0pF(1R0) | 3 | | | 5 | 5.9pF(5R9) | 3 | | | 5 | 22pF(220) | | 3 | | |
| 1.1pF(1R1) | 3 | | | 5 | 6.0pF(6R0) | 3 | | | 5 | 24pF(240) | | 3 | | |
| 1.2pF(1R2) | 3 | | | 5 | 6.1pF(6R1) | 3 | | | 5 | 27pF(270) | | 3 | | |
| 1.3pF(1R3) | 3 | | | 5 | 6.2pF(6R2) | 3 | | | 5 | 30pF(300) | | 3 | | |
| 1.4pF(1R4) | 3 | | | 5 | 6.3pF(6R3) | 3 | | | 5 | 33pF(330) | | 3 | | |
| 1.5pF(1R5) | 3 | | | 5 | 6.4pF(6R4) | 3 | | | 5 | | | | | |
| 1.6pF(1R6) | 3 | | | 5 | 6.5pF(6R5) | 3 | | | 5 | | | | | |
| 1.7pF(1R7) | 3 | | | 5 | 6.6pF(6R6) | 3 | | | 5 | | | | | |
| 1.8pF(1R8) | 3 | | | 5 | 6.7pF(6R7) | 3 | | | 5 | | | | | |
| 1.9pF(1R9) | 3 | | | 5 | 6.8pF(6R8) | 3 | | | 5 | | | | | |
| 2.0pF(2R0) | 3 | | | 5 | 6.9pF(6R9) | 3 | | | 5 | | | | | |
| 2.1pF(2R1) | 3 | | | 5 | 7.0pF(7R0) | 3 | | | 5 | | | | | |
| 2.2pF(2R2) | 3 | | | 5 | 7.1pF(7R1) | 3 | | | 5 | | | | | |
| 2.3pF(2R3) | 3 | | | 5 | 7.2pF(7R2) | 3 | | | 5 | | | | | |
| 2.4pF(2R4) | 3 | | | 5 | 7.3pF(7R3) | 3 | | | 5 | | | | | |
| 2.5pF(2R5) | 3 | | | 5 | 7.4pF(7R4) | 3 | | | 5 | | | | | |
| 2.6pF(2R6) | 3 | | | 5 | 7.5pF(7R5) | 3 | | | 5 | | | | | |
| 2.7pF(2R7) | 3 | | | 5 | 7.6pF(7R6) | 3 | | | 5 | | | | | |
| 2.8pF(2R8) | 3 | | | 5 | 7.7pF(7R7) | 3 | | | 5 | | | | | |
| 2.9pF(2R9) | 3 | | | 5 | 7.8pF(7R8) | 3 | | | 5 | | | | | |
| 3.0pF(3R0) | 3 | | | 5 | 7.9pF(7R9) | 3 | | | 5 | | | | | |
| 3.1pF(3R1) | 3 | | | 5 | 8.0pF(8R0) | 3 | | | 5 | | | | | |
| 3.2pF(3R2) | 3 | | | 5 | 8.1pF(8R1) | 3 | | | 5 | | | | | |
| 3.3pF(3R3) | 3 | | | 5 | 8.2pF(8R2) | 3 | | | 5 | | | | | |
| 3.4pF(3R4) | 3 | | | 5 | 8.3pF(8R3) | 3 | | | 5 | | | | | |
| 3.5pF(3R5) | 3 | | | 5 | 8.4pF(8R4) | 3 | | | 5 | | | | | |
| 3.6pF(3R6) | 3 | | | 5 | 8.5pF(8R5) | 3 | | | 5 | | | | | |
| 3.7pF(3R7) | 3 | | | 5 | 8.6pF(8R6) | 3 | | | 5 | | | | | |
| 3.8pF(3R8) | 3 | | | 5 | 8.7pF(8R7) | 3 | | | 5 | | | | | |
| 3.9pF(3R9) | 3 | | | 5 | 8.8pF(8R8) | 3 | | | 5 | | | | | |
| 4.0pF(4R0) | 3 | | | 5 | 8.9pF(8R9) | 3 | | | 5 | | | | | |
| 4.1pF(4R1) | 3 | | | 5 | 9.0pF(9R0) | 3 | | | 5 | | | | | |
| 4.2pF(4R2) | 3 | | | 5 | 9.1pF(9R1) | 3 | | | 5 | | | | | |
| 4.3pF(4R3) | 3 | | | 5 | 9.2pF(9R2) | 3 | | | 5 | | | | | |
| 4.4pF(4R4) | 3 | | | 5 | 9.3pF(9R3) | 3 | | | 5 | | | | | |
| 4.5pF(4R5) | 3 | | | 5 | 9.4pF(9R4) | 3 | | | 5 | | | | | |
| 4.6pF(4R6) | 3 | | | 5 | 9.5pF(9R5) | 3 | | | 5 | | | | | |
| 4.7pF(4R7) | 3 | | | 5 | 9.6pF(9R6) | 3 | | | 5 | | | | | |
| 4.8pF(4R8) | 3 | | | 5 | 9.7pF(9R7) | 3 | | | 5 | | | | | |
| 4.9pF(4R9) | 3 | | | 5 | 9.8pF(9R8) | 3 | | | 5 | | | | | |

The part number code is shown in () and Unit is shown in []. < >: EIA [inch] Code

Temperature Compensating Type C0G(5C) Characteristics

| LxW [mm] | | 0.6x0.3(03)<0201> | 1.0x0.5(15)<0402> |
|-------------------|------------|--------------------|--------------------|
| Rated Volt. [Vdc] | | 25(1E) | 50(1H) |
| Capacitance | Tolerance | Part Number | |
| 0.1pF(R10) | ±0.05pF(W) | | GJM1555C1HR10WB01D |
| | ±0.1pF(B) | | GJM1555C1HR10BB01D |
| 0.2pF(R20) | ±0.05pF(W) | GJM0335C1ER20WB01D | GJM1555C1HR20WB01D |
| | ±0.1pF(B) | GJM0335C1ER20BB01D | GJM1555C1HR20BB01D |
| 0.3pF(R30) | ±0.05pF(W) | GJM0335C1ER30WB01D | GJM1555C1HR30WB01D |
| | ±0.1pF(B) | GJM0335C1ER30BB01D | GJM1555C1HR30BB01D |
| 0.4pF(R40) | ±0.05pF(W) | GJM0335C1ER40WB01D | GJM1555C1HR40WB01D |
| | ±0.1pF(B) | GJM0335C1ER40BB01D | GJM1555C1HR40BB01D |
| 0.5pF(R50) | ±0.05pF(W) | GJM0335C1ER50WB01D | GJM1555C1HR50WB01D |
| | ±0.1pF(B) | GJM0335C1ER50BB01D | GJM1555C1HR50BB01D |
| 0.6pF(R60) | ±0.05pF(W) | GJM0335C1ER60WB01D | GJM1555C1HR60WB01D |
| | ±0.1pF(B) | GJM0335C1ER60BB01D | GJM1555C1HR60BB01D |
| 0.7pF(R70) | ±0.05pF(W) | GJM0335C1ER70WB01D | GJM1555C1HR70WB01D |
| | ±0.1pF(B) | GJM0335C1ER70BB01D | GJM1555C1HR70BB01D |
| 0.8pF(R80) | ±0.05pF(W) | GJM0335C1ER80WB01D | GJM1555C1HR80WB01D |
| | ±0.1pF(B) | GJM0335C1ER80BB01D | GJM1555C1HR80BB01D |
| 0.9pF(R90) | ±0.05pF(W) | GJM0335C1ER90WB01D | GJM1555C1HR90WB01D |
| | ±0.1pF(B) | GJM0335C1ER90BB01D | GJM1555C1HR90BB01D |
| 1.0pF(1R0) | ±0.05pF(W) | GJM0335C1E1R0WB01D | GJM1555C1H1R0WB01D |
| | ±0.1pF(B) | GJM0335C1E1R0BB01D | GJM1555C1H1R0BB01D |
| | ±0.25pF(C) | GJM0335C1E1R0CB01D | GJM1555C1H1R0CB01D |
| 1.1pF(1R1) | ±0.05pF(W) | GJM0335C1E1R1WB01D | GJM1555C1H1R1WB01D |
| | ±0.1pF(B) | GJM0335C1E1R1BB01D | GJM1555C1H1R1BB01D |
| | ±0.25pF(C) | GJM0335C1E1R1CB01D | GJM1555C1H1R1CB01D |
| 1.2pF(1R2) | ±0.05pF(W) | GJM0335C1E1R2WB01D | GJM1555C1H1R2WB01D |
| | ±0.1pF(B) | GJM0335C1E1R2BB01D | GJM1555C1H1R2BB01D |
| | ±0.25pF(C) | GJM0335C1E1R2CB01D | GJM1555C1H1R2CB01D |
| 1.3pF(1R3) | ±0.05pF(W) | GJM0335C1E1R3WB01D | GJM1555C1H1R3WB01D |
| | ±0.1pF(B) | GJM0335C1E1R3BB01D | GJM1555C1H1R3BB01D |
| | ±0.25pF(C) | GJM0335C1E1R3CB01D | GJM1555C1H1R3CB01D |
| 1.4pF(1R4) | ±0.05pF(W) | GJM0335C1E1R4WB01D | GJM1555C1H1R4WB01D |
| | ±0.1pF(B) | GJM0335C1E1R4BB01D | GJM1555C1H1R4BB01D |
| | ±0.25pF(C) | GJM0335C1E1R4CB01D | GJM1555C1H1R4CB01D |
| 1.5pF(1R5) | ±0.05pF(W) | GJM0335C1E1R5WB01D | GJM1555C1H1R5WB01D |
| | ±0.1pF(B) | GJM0335C1E1R5BB01D | GJM1555C1H1R5BB01D |
| | ±0.25pF(C) | GJM0335C1E1R5CB01D | GJM1555C1H1R5CB01D |
| 1.6pF(1R6) | ±0.05pF(W) | GJM0335C1E1R6WB01D | GJM1555C1H1R6WB01D |
| | ±0.1pF(B) | GJM0335C1E1R6BB01D | GJM1555C1H1R6BB01D |
| | ±0.25pF(C) | GJM0335C1E1R6CB01D | GJM1555C1H1R6CB01D |
| 1.7pF(1R7) | ±0.05pF(W) | GJM0335C1E1R7WB01D | GJM1555C1H1R7WB01D |
| | ±0.1pF(B) | GJM0335C1E1R7BB01D | GJM1555C1H1R7BB01D |
| | ±0.25pF(C) | GJM0335C1E1R7CB01D | GJM1555C1H1R7CB01D |
| 1.8pF(1R8) | ±0.05pF(W) | GJM0335C1E1R8WB01D | GJM1555C1H1R8WB01D |
| | ±0.1pF(B) | GJM0335C1E1R8BB01D | GJM1555C1H1R8BB01D |
| | ±0.25pF(C) | GJM0335C1E1R8CB01D | GJM1555C1H1R8CB01D |
| 1.9pF(1R9) | ±0.05pF(W) | GJM0335C1E1R9WB01D | GJM1555C1H1R9WB01D |
| | ±0.1pF(B) | GJM0335C1E1R9BB01D | GJM1555C1H1R9BB01D |
| | ±0.25pF(C) | GJM0335C1E1R9CB01D | GJM1555C1H1R9CB01D |

The part number code is shown in () and Unit is shown in []. <>: EIA [inch] Code

(Part Number) **GJ** **M** **03** **3** **5C** **1E** **R20** **W** **B01** **D** ①Product ID ②Series ③Dimensions (LxW) ④Dimension (T)
 ⑤Temperature Characteristics ⑥Rated Voltage ⑦Capacitance
 ⑧Capacitance Tolerance ⑨Individual Specification Code ⑩Packaging

Packaging Code in Part Number shows STD 180mm Reel Taping.

Temperature Compensating Type C0G(5C) Characteristics

| LxW [mm] | | 0.6x0.3(03)<0201> | 1.0x0.5(15)<0402> |
|-------------------|------------|--------------------|--------------------|
| Rated Volt. [Vdc] | | 25(1E) | 50(1H) |
| Capacitance | Tolerance | Part Number | |
| 2.0pF(2R0) | ±0.05pF(W) | GJM0335C1E2R0WB01D | GJM1555C1H2R0WB01D |
| | ±0.1pF(B) | GJM0335C1E2R0BB01D | GJM1555C1H2R0BB01D |
| | ±0.25pF(C) | GJM0335C1E2R0CB01D | GJM1555C1H2R0CB01D |
| 2.1pF(2R1) | ±0.05pF(W) | GJM0335C1E2R1WB01D | GJM1555C1H2R1WB01D |
| | ±0.1pF(B) | GJM0335C1E2R1BB01D | GJM1555C1H2R1BB01D |
| | ±0.25pF(C) | GJM0335C1E2R1CB01D | GJM1555C1H2R1CB01D |
| 2.2pF(2R2) | ±0.05pF(W) | GJM0335C1E2R2WB01D | GJM1555C1H2R2WB01D |
| | ±0.1pF(B) | GJM0335C1E2R2BB01D | GJM1555C1H2R2BB01D |
| | ±0.25pF(C) | GJM0335C1E2R2CB01D | GJM1555C1H2R2CB01D |
| 2.3pF(2R3) | ±0.05pF(W) | GJM0335C1E2R3WB01D | GJM1555C1H2R3WB01D |
| | ±0.1pF(B) | GJM0335C1E2R3BB01D | GJM1555C1H2R3BB01D |
| | ±0.25pF(C) | GJM0335C1E2R3CB01D | GJM1555C1H2R3CB01D |
| 2.4pF(2R4) | ±0.05pF(W) | GJM0335C1E2R4WB01D | GJM1555C1H2R4WB01D |
| | ±0.1pF(B) | GJM0335C1E2R4BB01D | GJM1555C1H2R4BB01D |
| | ±0.25pF(C) | GJM0335C1E2R4CB01D | GJM1555C1H2R4CB01D |
| 2.5pF(2R5) | ±0.05pF(W) | GJM0335C1E2R5WB01D | GJM1555C1H2R5WB01D |
| | ±0.1pF(B) | GJM0335C1E2R5BB01D | GJM1555C1H2R5BB01D |
| | ±0.25pF(C) | GJM0335C1E2R5CB01D | GJM1555C1H2R5CB01D |
| 2.6pF(2R6) | ±0.05pF(W) | GJM0335C1E2R6WB01D | GJM1555C1H2R6WB01D |
| | ±0.1pF(B) | GJM0335C1E2R6BB01D | GJM1555C1H2R6BB01D |
| | ±0.25pF(C) | GJM0335C1E2R6CB01D | GJM1555C1H2R6CB01D |
| 2.7pF(2R7) | ±0.05pF(W) | GJM0335C1E2R7WB01D | GJM1555C1H2R7WB01D |
| | ±0.1pF(B) | GJM0335C1E2R7BB01D | GJM1555C1H2R7BB01D |
| | ±0.25pF(C) | GJM0335C1E2R7CB01D | GJM1555C1H2R7CB01D |
| 2.8pF(2R8) | ±0.05pF(W) | GJM0335C1E2R8WB01D | GJM1555C1H2R8WB01D |
| | ±0.1pF(B) | GJM0335C1E2R8BB01D | GJM1555C1H2R8BB01D |
| | ±0.25pF(C) | GJM0335C1E2R8CB01D | GJM1555C1H2R8CB01D |
| 2.9pF(2R9) | ±0.05pF(W) | GJM0335C1E2R9WB01D | GJM1555C1H2R9WB01D |
| | ±0.1pF(B) | GJM0335C1E2R9BB01D | GJM1555C1H2R9BB01D |
| | ±0.25pF(C) | GJM0335C1E2R9CB01D | GJM1555C1H2R9CB01D |
| 3.0pF(3R0) | ±0.05pF(W) | GJM0335C1E3R0WB01D | GJM1555C1H3R0WB01D |
| | ±0.1pF(B) | GJM0335C1E3R0BB01D | GJM1555C1H3R0BB01D |
| | ±0.25pF(C) | GJM0335C1E3R0CB01D | GJM1555C1H3R0CB01D |
| 3.1pF(3R1) | ±0.05pF(W) | GJM0335C1E3R1WB01D | GJM1555C1H3R1WB01D |
| | ±0.1pF(B) | GJM0335C1E3R1BB01D | GJM1555C1H3R1BB01D |
| | ±0.25pF(C) | GJM0335C1E3R1CB01D | GJM1555C1H3R1CB01D |
| 3.2pF(3R2) | ±0.05pF(W) | GJM0335C1E3R2WB01D | GJM1555C1H3R2WB01D |
| | ±0.1pF(B) | GJM0335C1E3R2BB01D | GJM1555C1H3R2BB01D |
| | ±0.25pF(C) | GJM0335C1E3R2CB01D | GJM1555C1H3R2CB01D |
| 3.3pF(3R3) | ±0.05pF(W) | GJM0335C1E3R3WB01D | GJM1555C1H3R3WB01D |
| | ±0.1pF(B) | GJM0335C1E3R3BB01D | GJM1555C1H3R3BB01D |
| | ±0.25pF(C) | GJM0335C1E3R3CB01D | GJM1555C1H3R3CB01D |
| 3.4pF(3R4) | ±0.05pF(W) | GJM0335C1E3R4WB01D | GJM1555C1H3R4WB01D |
| | ±0.1pF(B) | GJM0335C1E3R4BB01D | GJM1555C1H3R4BB01D |
| | ±0.25pF(C) | GJM0335C1E3R4CB01D | GJM1555C1H3R4CB01D |
| 3.5pF(3R5) | ±0.05pF(W) | GJM0335C1E3R5WB01D | GJM1555C1H3R5WB01D |
| | ±0.1pF(B) | GJM0335C1E3R5BB01D | GJM1555C1H3R5BB01D |
| | ±0.25pF(C) | GJM0335C1E3R5CB01D | GJM1555C1H3R5CB01D |

The part number code is shown in () and Unit is shown in []. < >: EIA [inch] Code

- | | | | | |
|---------------|--|--|--|---|
| (Part Number) | G J M 03 3 5C 1E 2R0 W B01 D | ① Product ID ② Series ⑤ Temperature Characteristics ⑧ Capacitance Tolerance | ③ Dimensions (LxW) ⑥ Rated Voltage ⑨ Individual Specification Code | ④ Dimension (T) ⑦ Capacitance ⑩ Packaging |
|---------------|--|--|--|---|

Packaging Code in Part Number shows STD 180mm Reel Taping.

Temperature Compensating Type C0G(5C) Characteristics

| LxW [mm] | | 0.6x0.3(03)<0201> | 1.0x0.5(15)<0402> |
|-------------------|------------|--------------------|--------------------|
| Rated Volt. [Vdc] | | 25(1E) | 50(1H) |
| Capacitance | Tolerance | Part Number | |
| 3.6pF(3R6) | ±0.05pF(W) | GJM0335C1E3R6WB01D | GJM1555C1H3R6WB01D |
| | ±0.1pF(B) | GJM0335C1E3R6BB01D | GJM1555C1H3R6BB01D |
| | ±0.25pF(C) | GJM0335C1E3R6CB01D | GJM1555C1H3R6CB01D |
| 3.7pF(3R7) | ±0.05pF(W) | GJM0335C1E3R7WB01D | GJM1555C1H3R7WB01D |
| | ±0.1pF(B) | GJM0335C1E3R7BB01D | GJM1555C1H3R7BB01D |
| | ±0.25pF(C) | GJM0335C1E3R7CB01D | GJM1555C1H3R7CB01D |
| 3.8pF(3R8) | ±0.05pF(W) | GJM0335C1E3R8WB01D | GJM1555C1H3R8WB01D |
| | ±0.1pF(B) | GJM0335C1E3R8BB01D | GJM1555C1H3R8BB01D |
| | ±0.25pF(C) | GJM0335C1E3R8CB01D | GJM1555C1H3R8CB01D |
| 3.9pF(3R9) | ±0.05pF(W) | GJM0335C1E3R9WB01D | GJM1555C1H3R9WB01D |
| | ±0.1pF(B) | GJM0335C1E3R9BB01D | GJM1555C1H3R9BB01D |
| | ±0.25pF(C) | GJM0335C1E3R9CB01D | GJM1555C1H3R9CB01D |
| 4.0pF(4R0) | ±0.05pF(W) | GJM0335C1E4R0WB01D | GJM1555C1H4R0WB01D |
| | ±0.1pF(B) | GJM0335C1E4R0BB01D | GJM1555C1H4R0BB01D |
| | ±0.25pF(C) | GJM0335C1E4R0CB01D | GJM1555C1H4R0CB01D |
| 4.1pF(4R1) | ±0.05pF(W) | GJM0335C1E4R1WB01D | GJM1555C1H4R1WB01D |
| | ±0.1pF(B) | GJM0335C1E4R1BB01D | GJM1555C1H4R1BB01D |
| | ±0.25pF(C) | GJM0335C1E4R1CB01D | GJM1555C1H4R1CB01D |
| 4.2pF(4R2) | ±0.05pF(W) | GJM0335C1E4R2WB01D | GJM1555C1H4R2WB01D |
| | ±0.1pF(B) | GJM0335C1E4R2BB01D | GJM1555C1H4R2BB01D |
| | ±0.25pF(C) | GJM0335C1E4R2CB01D | GJM1555C1H4R2CB01D |
| 4.3pF(4R3) | ±0.05pF(W) | GJM0335C1E4R3WB01D | GJM1555C1H4R3WB01D |
| | ±0.1pF(B) | GJM0335C1E4R3BB01D | GJM1555C1H4R3BB01D |
| | ±0.25pF(C) | GJM0335C1E4R3CB01D | GJM1555C1H4R3CB01D |
| 4.4pF(4R4) | ±0.05pF(W) | GJM0335C1E4R4WB01D | GJM1555C1H4R4WB01D |
| | ±0.1pF(B) | GJM0335C1E4R4BB01D | GJM1555C1H4R4BB01D |
| | ±0.25pF(C) | GJM0335C1E4R4CB01D | GJM1555C1H4R4CB01D |
| 4.5pF(4R5) | ±0.05pF(W) | GJM0335C1E4R5WB01D | GJM1555C1H4R5WB01D |
| | ±0.1pF(B) | GJM0335C1E4R5BB01D | GJM1555C1H4R5BB01D |
| | ±0.25pF(C) | GJM0335C1E4R5CB01D | GJM1555C1H4R5CB01D |
| 4.6pF(4R6) | ±0.05pF(W) | GJM0335C1E4R6WB01D | GJM1555C1H4R6WB01D |
| | ±0.1pF(B) | GJM0335C1E4R6BB01D | GJM1555C1H4R6BB01D |
| | ±0.25pF(C) | GJM0335C1E4R6CB01D | GJM1555C1H4R6CB01D |
| 4.7pF(4R7) | ±0.05pF(W) | GJM0335C1E4R7WB01D | GJM1555C1H4R7WB01D |
| | ±0.1pF(B) | GJM0335C1E4R7BB01D | GJM1555C1H4R7BB01D |
| | ±0.25pF(C) | GJM0335C1E4R7CB01D | GJM1555C1H4R7CB01D |
| 4.8pF(4R8) | ±0.05pF(W) | GJM0335C1E4R8WB01D | GJM1555C1H4R8WB01D |
| | ±0.1pF(B) | GJM0335C1E4R8BB01D | GJM1555C1H4R8BB01D |
| | ±0.25pF(C) | GJM0335C1E4R8CB01D | GJM1555C1H4R8CB01D |
| 4.9pF(4R9) | ±0.05pF(W) | GJM0335C1E4R9WB01D | GJM1555C1H4R9WB01D |
| | ±0.1pF(B) | GJM0335C1E4R9BB01D | GJM1555C1H4R9BB01D |
| | ±0.25pF(C) | GJM0335C1E4R9CB01D | GJM1555C1H4R9CB01D |
| 5.0pF(5R0) | ±0.05pF(W) | GJM0335C1E5R0WB01D | GJM1555C1H5R0WB01D |
| | ±0.1pF(B) | GJM0335C1E5R0BB01D | GJM1555C1H5R0BB01D |
| | ±0.25pF(C) | GJM0335C1E5R0CB01D | GJM1555C1H5R0CB01D |
| 5.1pF(5R1) | ±0.05pF(W) | GJM0335C1E5R1WB01D | GJM1555C1H5R1WB01D |
| | ±0.1pF(B) | GJM0335C1E5R1BB01D | GJM1555C1H5R1BB01D |
| | ±0.25pF(C) | GJM0335C1E5R1CB01D | GJM1555C1H5R1CB01D |
| | ±0.5pF(D) | GJM0335C1E5R1DB01D | GJM1555C1H5R1DB01D |

The part number code is shown in () and Unit is shown in []. < >: EIA [inch] Code

For General GRM Series

Array GNM Series

Low ESL LL□ Series

High-Q GJM Series

High Frequency GQM Series

Monolithic Microchip GMA Series

For Bonding GMD Series

Product Information

Temperature Compensating Type C0G(5C) Characteristics

| LxW [mm] | | 0.6x0.3(03)<0201> | 1.0x0.5(15)<0402> |
|-------------------|------------|--------------------|--------------------|
| Rated Volt. [Vdc] | | 25(1E) | 50(1H) |
| Capacitance | Tolerance | Part Number | |
| 5.2pF(5R2) | ±0.05pF(W) | GJM0335C1E5R2WB01D | GJM1555C1H5R2WB01D |
| | ±0.1pF(B) | GJM0335C1E5R2BB01D | GJM1555C1H5R2BB01D |
| | ±0.25pF(C) | GJM0335C1E5R2CB01D | GJM1555C1H5R2CB01D |
| | ±0.5pF(D) | GJM0335C1E5R2DB01D | GJM1555C1H5R2DB01D |
| 5.3pF(5R3) | ±0.05pF(W) | GJM0335C1E5R3WB01D | GJM1555C1H5R3WB01D |
| | ±0.1pF(B) | GJM0335C1E5R3BB01D | GJM1555C1H5R3BB01D |
| | ±0.25pF(C) | GJM0335C1E5R3CB01D | GJM1555C1H5R3CB01D |
| | ±0.5pF(D) | GJM0335C1E5R3DB01D | GJM1555C1H5R3DB01D |
| 5.4pF(5R4) | ±0.05pF(W) | GJM0335C1E5R4WB01D | GJM1555C1H5R4WB01D |
| | ±0.1pF(B) | GJM0335C1E5R4BB01D | GJM1555C1H5R4BB01D |
| | ±0.25pF(C) | GJM0335C1E5R4CB01D | GJM1555C1H5R4CB01D |
| | ±0.5pF(D) | GJM0335C1E5R4DB01D | GJM1555C1H5R4DB01D |
| 5.5pF(5R5) | ±0.05pF(W) | GJM0335C1E5R5WB01D | GJM1555C1H5R5WB01D |
| | ±0.1pF(B) | GJM0335C1E5R5BB01D | GJM1555C1H5R5BB01D |
| | ±0.25pF(C) | GJM0335C1E5R5CB01D | GJM1555C1H5R5CB01D |
| | ±0.5pF(D) | GJM0335C1E5R5DB01D | GJM1555C1H5R5DB01D |
| 5.6pF(5R6) | ±0.05pF(W) | GJM0335C1E5R6WB01D | GJM1555C1H5R6WB01D |
| | ±0.1pF(B) | GJM0335C1E5R6BB01D | GJM1555C1H5R6BB01D |
| | ±0.25pF(C) | GJM0335C1E5R6CB01D | GJM1555C1H5R6CB01D |
| | ±0.5pF(D) | GJM0335C1E5R6DB01D | GJM1555C1H5R6DB01D |
| 5.7pF(5R7) | ±0.05pF(W) | GJM0335C1E5R7WB01D | GJM1555C1H5R7WB01D |
| | ±0.1pF(B) | GJM0335C1E5R7BB01D | GJM1555C1H5R7BB01D |
| | ±0.25pF(C) | GJM0335C1E5R7CB01D | GJM1555C1H5R7CB01D |
| | ±0.5pF(D) | GJM0335C1E5R7DB01D | GJM1555C1H5R7DB01D |
| 5.8pF(5R8) | ±0.05pF(W) | GJM0335C1E5R8WB01D | GJM1555C1H5R8WB01D |
| | ±0.1pF(B) | GJM0335C1E5R8BB01D | GJM1555C1H5R8BB01D |
| | ±0.25pF(C) | GJM0335C1E5R8CB01D | GJM1555C1H5R8CB01D |
| | ±0.5pF(D) | GJM0335C1E5R8DB01D | GJM1555C1H5R8DB01D |
| 5.9pF(5R9) | ±0.05pF(W) | GJM0335C1E5R9WB01D | GJM1555C1H5R9WB01D |
| | ±0.1pF(B) | GJM0335C1E5R9BB01D | GJM1555C1H5R9BB01D |
| | ±0.25pF(C) | GJM0335C1E5R9CB01D | GJM1555C1H5R9CB01D |
| | ±0.5pF(D) | GJM0335C1E5R9DB01D | GJM1555C1H5R9DB01D |
| 6.0pF(6R0) | ±0.05pF(W) | GJM0335C1E6R0WB01D | GJM1555C1H6R0WB01D |
| | ±0.1pF(B) | GJM0335C1E6R0BB01D | GJM1555C1H6R0BB01D |
| | ±0.25pF(C) | GJM0335C1E6R0CB01D | GJM1555C1H6R0CB01D |
| | ±0.5pF(D) | GJM0335C1E6R0DB01D | GJM1555C1H6R0DB01D |
| 6.1pF(6R1) | ±0.05pF(W) | GJM0335C1E6R1WB01D | GJM1555C1H6R1WB01D |
| | ±0.1pF(B) | GJM0335C1E6R1BB01D | GJM1555C1H6R1BB01D |
| | ±0.25pF(C) | GJM0335C1E6R1CB01D | GJM1555C1H6R1CB01D |
| | ±0.5pF(D) | GJM0335C1E6R1DB01D | GJM1555C1H6R1DB01D |
| 6.2pF(6R2) | ±0.05pF(W) | GJM0335C1E6R2WB01D | GJM1555C1H6R2WB01D |
| | ±0.1pF(B) | GJM0335C1E6R2BB01D | GJM1555C1H6R2BB01D |
| | ±0.25pF(C) | GJM0335C1E6R2CB01D | GJM1555C1H6R2CB01D |
| | ±0.5pF(D) | GJM0335C1E6R2DB01D | GJM1555C1H6R2DB01D |
| 6.3pF(6R3) | ±0.05pF(W) | GJM0335C1E6R3WB01D | GJM1555C1H6R3WB01D |
| | ±0.1pF(B) | GJM0335C1E6R3BB01D | GJM1555C1H6R3BB01D |
| | ±0.25pF(C) | GJM0335C1E6R3CB01D | GJM1555C1H6R3CB01D |
| | ±0.5pF(D) | GJM0335C1E6R3DB01D | GJM1555C1H6R3DB01D |

The part number code is shown in () and Unit is shown in []. < >: EIA [inch] Code

- | | | | |
|---------------|---|---|--|
| (Part Number) | <div style="display: flex; justify-content: space-around; font-size: 10px;"> GJ M 03 3 5C 1E 5R2 W B01 D </div> | <ul style="list-style-type: none"> ① Product ID ② Series ③ Dimensions (LxW) ④ Dimension (T) ⑤ Temperature Characteristics ⑥ Rated Voltage ⑦ Capacitance ⑧ Capacitance Tolerance ⑨ Individual Specification Code ⑩ Packaging | |
|---------------|---|---|--|

Packaging Code in Part Number shows STD 180mm Reel Taping.

Temperature Compensating Type C0G(5C)/C0H(6C) Characteristics

| LxW [mm] | | 0.6x0.3(03)<0201> | 1.0x0.5(15)<0402> |
|-------------------|------------|--------------------|--------------------|
| Rated Volt. [Vdc] | | 25(1E) | 50(1H) |
| Capacitance | Tolerance | Part Number | |
| 6.4pF(6R4) | ±0.05pF(W) | GJM0335C1E6R4WB01D | GJM1555C1H6R4WB01D |
| | ±0.1pF(B) | GJM0335C1E6R4BB01D | GJM1555C1H6R4BB01D |
| | ±0.25pF(C) | GJM0335C1E6R4CB01D | GJM1555C1H6R4CB01D |
| | ±0.5pF(D) | GJM0335C1E6R4DB01D | GJM1555C1H6R4DB01D |
| 6.5pF(6R5) | ±0.05pF(W) | GJM0335C1E6R5WB01D | GJM1555C1H6R5WB01D |
| | ±0.1pF(B) | GJM0335C1E6R5BB01D | GJM1555C1H6R5BB01D |
| | ±0.25pF(C) | GJM0335C1E6R5CB01D | GJM1555C1H6R5CB01D |
| | ±0.5pF(D) | GJM0335C1E6R5DB01D | GJM1555C1H6R5DB01D |
| 6.6pF(6R6) | ±0.05pF(W) | GJM0335C1E6R6WB01D | GJM1555C1H6R6WB01D |
| | ±0.1pF(B) | GJM0335C1E6R6BB01D | GJM1555C1H6R6BB01D |
| | ±0.25pF(C) | GJM0335C1E6R6CB01D | GJM1555C1H6R6CB01D |
| | ±0.5pF(D) | GJM0335C1E6R6DB01D | GJM1555C1H6R6DB01D |
| 6.7pF(6R7) | ±0.05pF(W) | GJM0335C1E6R7WB01D | GJM1555C1H6R7WB01D |
| | ±0.1pF(B) | GJM0335C1E6R7BB01D | GJM1555C1H6R7BB01D |
| | ±0.25pF(C) | GJM0335C1E6R7CB01D | GJM1555C1H6R7CB01D |
| | ±0.5pF(D) | GJM0335C1E6R7DB01D | GJM1555C1H6R7DB01D |
| 6.8pF(6R8) | ±0.05pF(W) | GJM0335C1E6R8WB01D | GJM1555C1H6R8WB01D |
| | ±0.1pF(B) | GJM0335C1E6R8BB01D | GJM1555C1H6R8BB01D |
| | ±0.25pF(C) | GJM0335C1E6R8CB01D | GJM1555C1H6R8CB01D |
| | ±0.5pF(D) | GJM0335C1E6R8DB01D | GJM1555C1H6R8DB01D |
| 6.9pF(6R9) | ±0.05pF(W) | GJM0336C1E6R9WB01D | GJM1555C1H6R9WB01D |
| | ±0.1pF(B) | GJM0336C1E6R9BB01D | GJM1555C1H6R9BB01D |
| | ±0.25pF(C) | GJM0336C1E6R9CB01D | GJM1555C1H6R9CB01D |
| | ±0.5pF(D) | GJM0336C1E6R9DB01D | GJM1555C1H6R9DB01D |
| 7.0pF(7R0) | ±0.05pF(W) | GJM0336C1E7R0WB01D | GJM1555C1H7R0WB01D |
| | ±0.1pF(B) | GJM0336C1E7R0BB01D | GJM1555C1H7R0BB01D |
| | ±0.25pF(C) | GJM0336C1E7R0CB01D | GJM1555C1H7R0CB01D |
| | ±0.5pF(D) | GJM0336C1E7R0DB01D | GJM1555C1H7R0DB01D |
| 7.1pF(7R1) | ±0.05pF(W) | GJM0336C1E7R1WB01D | GJM1555C1H7R1WB01D |
| | ±0.1pF(B) | GJM0336C1E7R1BB01D | GJM1555C1H7R1BB01D |
| | ±0.25pF(C) | GJM0336C1E7R1CB01D | GJM1555C1H7R1CB01D |
| | ±0.5pF(D) | GJM0336C1E7R1DB01D | GJM1555C1H7R1DB01D |
| 7.2pF(7R2) | ±0.05pF(W) | GJM0336C1E7R2WB01D | GJM1555C1H7R2WB01D |
| | ±0.1pF(B) | GJM0336C1E7R2BB01D | GJM1555C1H7R2BB01D |
| | ±0.25pF(C) | GJM0336C1E7R2CB01D | GJM1555C1H7R2CB01D |
| | ±0.5pF(D) | GJM0336C1E7R2DB01D | GJM1555C1H7R2DB01D |
| 7.3pF(7R3) | ±0.05pF(W) | GJM0336C1E7R3WB01D | GJM1555C1H7R3WB01D |
| | ±0.1pF(B) | GJM0336C1E7R3BB01D | GJM1555C1H7R3BB01D |
| | ±0.25pF(C) | GJM0336C1E7R3CB01D | GJM1555C1H7R3CB01D |
| | ±0.5pF(D) | GJM0336C1E7R3DB01D | GJM1555C1H7R3DB01D |
| 7.4pF(7R4) | ±0.05pF(W) | GJM0336C1E7R4WB01D | GJM1555C1H7R4WB01D |
| | ±0.1pF(B) | GJM0336C1E7R4BB01D | GJM1555C1H7R4BB01D |
| | ±0.25pF(C) | GJM0336C1E7R4CB01D | GJM1555C1H7R4CB01D |
| | ±0.5pF(D) | GJM0336C1E7R4DB01D | GJM1555C1H7R4DB01D |
| 7.5pF(7R5) | ±0.05pF(W) | GJM0336C1E7R5WB01D | GJM1555C1H7R5WB01D |
| | ±0.1pF(B) | GJM0336C1E7R5BB01D | GJM1555C1H7R5BB01D |
| | ±0.25pF(C) | GJM0336C1E7R5CB01D | GJM1555C1H7R5CB01D |
| | ±0.5pF(D) | GJM0336C1E7R5DB01D | GJM1555C1H7R5DB01D |
| 7.6pF(7R6) | ±0.05pF(W) | GJM0336C1E7R6WB01D | GJM1555C1H7R6WB01D |
| | ±0.1pF(B) | GJM0336C1E7R6BB01D | GJM1555C1H7R6BB01D |
| | ±0.25pF(C) | GJM0336C1E7R6CB01D | GJM1555C1H7R6CB01D |
| | ±0.5pF(D) | GJM0336C1E7R6DB01D | GJM1555C1H7R6DB01D |

The part number code is shown in () and Unit is shown in []. < >: EIA [inch] Code

Temperature Compensating Type C0G(5C)/C0H(6C) Characteristics

| LxW [mm] | | 0.6x0.3(03)<0201> | 1.0x0.5(15)<0402> |
|-------------------|------------|--------------------|--------------------|
| Rated Volt. [Vdc] | | 25(1E) | 50(1H) |
| Capacitance | Tolerance | Part Number | |
| 7.7pF(7R7) | ±0.05pF(W) | GJM0336C1E7R7WB01D | GJM1555C1H7R7WB01D |
| | ±0.1pF(B) | GJM0336C1E7R7BB01D | GJM1555C1H7R7BB01D |
| | ±0.25pF(C) | GJM0336C1E7R7CB01D | GJM1555C1H7R7CB01D |
| | ±0.5pF(D) | GJM0336C1E7R7DB01D | GJM1555C1H7R7DB01D |
| 7.8pF(7R8) | ±0.05pF(W) | GJM0336C1E7R8WB01D | GJM1555C1H7R8WB01D |
| | ±0.1pF(B) | GJM0336C1E7R8BB01D | GJM1555C1H7R8BB01D |
| | ±0.25pF(C) | GJM0336C1E7R8CB01D | GJM1555C1H7R8CB01D |
| | ±0.5pF(D) | GJM0336C1E7R8DB01D | GJM1555C1H7R8DB01D |
| 7.9pF(7R9) | ±0.05pF(W) | GJM0336C1E7R9WB01D | GJM1555C1H7R9WB01D |
| | ±0.1pF(B) | GJM0336C1E7R9BB01D | GJM1555C1H7R9BB01D |
| | ±0.25pF(C) | GJM0336C1E7R9CB01D | GJM1555C1H7R9CB01D |
| | ±0.5pF(D) | GJM0336C1E7R9DB01D | GJM1555C1H7R9DB01D |
| 8.0pF(8R0) | ±0.05pF(W) | GJM0336C1E8R0WB01D | GJM1555C1H8R0WB01D |
| | ±0.1pF(B) | GJM0336C1E8R0BB01D | GJM1555C1H8R0BB01D |
| | ±0.25pF(C) | GJM0336C1E8R0CB01D | GJM1555C1H8R0CB01D |
| | ±0.5pF(D) | GJM0336C1E8R0DB01D | GJM1555C1H8R0DB01D |
| 8.1pF(8R1) | ±0.05pF(W) | GJM0336C1E8R1WB01D | GJM1555C1H8R1WB01D |
| | ±0.1pF(B) | GJM0336C1E8R1BB01D | GJM1555C1H8R1BB01D |
| | ±0.25pF(C) | GJM0336C1E8R1CB01D | GJM1555C1H8R1CB01D |
| | ±0.5pF(D) | GJM0336C1E8R1DB01D | GJM1555C1H8R1DB01D |
| 8.2pF(8R2) | ±0.05pF(W) | GJM0336C1E8R2WB01D | GJM1555C1H8R2WB01D |
| | ±0.1pF(B) | GJM0336C1E8R2BB01D | GJM1555C1H8R2BB01D |
| | ±0.25pF(C) | GJM0336C1E8R2CB01D | GJM1555C1H8R2CB01D |
| | ±0.5pF(D) | GJM0336C1E8R2DB01D | GJM1555C1H8R2DB01D |
| 8.3pF(8R3) | ±0.05pF(W) | GJM0336C1E8R3WB01D | GJM1555C1H8R3WB01D |
| | ±0.1pF(B) | GJM0336C1E8R3BB01D | GJM1555C1H8R3BB01D |
| | ±0.25pF(C) | GJM0336C1E8R3CB01D | GJM1555C1H8R3CB01D |
| | ±0.5pF(D) | GJM0336C1E8R3DB01D | GJM1555C1H8R3DB01D |
| 8.4pF(8R4) | ±0.05pF(W) | GJM0336C1E8R4WB01D | GJM1555C1H8R4WB01D |
| | ±0.1pF(B) | GJM0336C1E8R4BB01D | GJM1555C1H8R4BB01D |
| | ±0.25pF(C) | GJM0336C1E8R4CB01D | GJM1555C1H8R4CB01D |
| | ±0.5pF(D) | GJM0336C1E8R4DB01D | GJM1555C1H8R4DB01D |
| 8.5pF(8R5) | ±0.05pF(W) | GJM0336C1E8R5WB01D | GJM1555C1H8R5WB01D |
| | ±0.1pF(B) | GJM0336C1E8R5BB01D | GJM1555C1H8R5BB01D |
| | ±0.25pF(C) | GJM0336C1E8R5CB01D | GJM1555C1H8R5CB01D |
| | ±0.5pF(D) | GJM0336C1E8R5DB01D | GJM1555C1H8R5DB01D |
| 8.6pF(8R6) | ±0.05pF(W) | GJM0336C1E8R6WB01D | GJM1555C1H8R6WB01D |
| | ±0.1pF(B) | GJM0336C1E8R6BB01D | GJM1555C1H8R6BB01D |
| | ±0.25pF(C) | GJM0336C1E8R6CB01D | GJM1555C1H8R6CB01D |
| | ±0.5pF(D) | GJM0336C1E8R6DB01D | GJM1555C1H8R6DB01D |
| 8.7pF(8R7) | ±0.05pF(W) | GJM0336C1E8R7WB01D | GJM1555C1H8R7WB01D |
| | ±0.1pF(B) | GJM0336C1E8R7BB01D | GJM1555C1H8R7BB01D |
| | ±0.25pF(C) | GJM0336C1E8R7CB01D | GJM1555C1H8R7CB01D |
| | ±0.5pF(D) | GJM0336C1E8R7DB01D | GJM1555C1H8R7DB01D |
| 8.8pF(8R8) | ±0.05pF(W) | GJM0336C1E8R8WB01D | GJM1555C1H8R8WB01D |
| | ±0.1pF(B) | GJM0336C1E8R8BB01D | GJM1555C1H8R8BB01D |
| | ±0.25pF(C) | GJM0336C1E8R8CB01D | GJM1555C1H8R8CB01D |
| | ±0.5pF(D) | GJM0336C1E8R8DB01D | GJM1555C1H8R8DB01D |

The part number code is shown in () and Unit is shown in []. < >: EIA [inch] Code

(Part Number) **GJ M 03 3 6C 1E 7R7 W B01 D** ①Product ID ②Series ③Dimensions (LxW) ④Dimension (T)
 ⑤Temperature Characteristics ⑥Rated Voltage ⑦Capacitance
 ⑧Capacitance Tolerance ⑨Individual Specification Code ⑩Packaging

Packaging Code in Part Number shows STD 180mm Reel Taping.

Temperature Compensating Type C0G(5C)/C0H(6C) Characteristics

| LxW [mm] | | 0.6x0.3(03)<0201> | 1.0x0.5(15)<0402> |
|-------------------|------------|--------------------|--------------------|
| Rated Volt. [Vdc] | | 25(1E) | 50(1H) |
| Capacitance | Tolerance | Part Number | |
| 8.9pF(8R9) | ±0.05pF(W) | GJM0336C1E8R9WB01D | GJM1555C1H8R9WB01D |
| | ±0.1pF(B) | GJM0336C1E8R9BB01D | GJM1555C1H8R9BB01D |
| | ±0.25pF(C) | GJM0336C1E8R9CB01D | GJM1555C1H8R9CB01D |
| | ±0.5pF(D) | GJM0336C1E8R9DB01D | GJM1555C1H8R9DB01D |
| 9.0pF(9R0) | ±0.05pF(W) | GJM0336C1E9R0WB01D | GJM1555C1H9R0WB01D |
| | ±0.1pF(B) | GJM0336C1E9R0BB01D | GJM1555C1H9R0BB01D |
| | ±0.25pF(C) | GJM0336C1E9R0CB01D | GJM1555C1H9R0CB01D |
| | ±0.5pF(D) | GJM0336C1E9R0DB01D | GJM1555C1H9R0DB01D |
| 9.1pF(9R1) | ±0.05pF(W) | GJM0336C1E9R1WB01D | GJM1555C1H9R1WB01D |
| | ±0.1pF(B) | GJM0336C1E9R1BB01D | GJM1555C1H9R1BB01D |
| | ±0.25pF(C) | GJM0336C1E9R1CB01D | GJM1555C1H9R1CB01D |
| | ±0.5pF(D) | GJM0336C1E9R1DB01D | GJM1555C1H9R1DB01D |
| 9.2pF(9R2) | ±0.05pF(W) | GJM0336C1E9R2WB01D | GJM1555C1H9R2WB01D |
| | ±0.1pF(B) | GJM0336C1E9R2BB01D | GJM1555C1H9R2BB01D |
| | ±0.25pF(C) | GJM0336C1E9R2CB01D | GJM1555C1H9R2CB01D |
| | ±0.5pF(D) | GJM0336C1E9R2DB01D | GJM1555C1H9R2DB01D |
| 9.3pF(9R3) | ±0.05pF(W) | GJM0336C1E9R3WB01D | GJM1555C1H9R3WB01D |
| | ±0.1pF(B) | GJM0336C1E9R3BB01D | GJM1555C1H9R3BB01D |
| | ±0.25pF(C) | GJM0336C1E9R3CB01D | GJM1555C1H9R3CB01D |
| | ±0.5pF(D) | GJM0336C1E9R3DB01D | GJM1555C1H9R3DB01D |
| 9.4pF(9R4) | ±0.05pF(W) | GJM0336C1E9R4WB01D | GJM1555C1H9R4WB01D |
| | ±0.1pF(B) | GJM0336C1E9R4BB01D | GJM1555C1H9R4BB01D |
| | ±0.25pF(C) | GJM0336C1E9R4CB01D | GJM1555C1H9R4CB01D |
| | ±0.5pF(D) | GJM0336C1E9R4DB01D | GJM1555C1H9R4DB01D |
| 9.5pF(9R5) | ±0.05pF(W) | GJM0336C1E9R5WB01D | GJM1555C1H9R5WB01D |
| | ±0.1pF(B) | GJM0336C1E9R5BB01D | GJM1555C1H9R5BB01D |
| | ±0.25pF(C) | GJM0336C1E9R5CB01D | GJM1555C1H9R5CB01D |
| | ±0.5pF(D) | GJM0336C1E9R5DB01D | GJM1555C1H9R5DB01D |
| 9.6pF(9R6) | ±0.05pF(W) | GJM0336C1E9R6WB01D | GJM1555C1H9R6WB01D |
| | ±0.1pF(B) | GJM0336C1E9R6BB01D | GJM1555C1H9R6BB01D |
| | ±0.25pF(C) | GJM0336C1E9R6CB01D | GJM1555C1H9R6CB01D |
| | ±0.5pF(D) | GJM0336C1E9R6DB01D | GJM1555C1H9R6DB01D |
| 9.7pF(9R7) | ±0.05pF(W) | GJM0336C1E9R7WB01D | GJM1555C1H9R7WB01D |
| | ±0.1pF(B) | GJM0336C1E9R7BB01D | GJM1555C1H9R7BB01D |
| | ±0.25pF(C) | GJM0336C1E9R7CB01D | GJM1555C1H9R7CB01D |
| | ±0.5pF(D) | GJM0336C1E9R7DB01D | GJM1555C1H9R7DB01D |
| 9.8pF(9R8) | ±0.05pF(W) | GJM0336C1E9R8WB01D | GJM1555C1H9R8WB01D |
| | ±0.1pF(B) | GJM0336C1E9R8BB01D | GJM1555C1H9R8BB01D |
| | ±0.25pF(C) | GJM0336C1E9R8CB01D | GJM1555C1H9R8CB01D |
| | ±0.5pF(D) | GJM0336C1E9R8DB01D | GJM1555C1H9R8DB01D |
| 9.9pF(9R9) | ±0.05pF(W) | GJM0336C1E9R9WB01D | GJM1555C1H9R9WB01D |
| | ±0.1pF(B) | GJM0336C1E9R9BB01D | GJM1555C1H9R9BB01D |
| | ±0.25pF(C) | GJM0336C1E9R9CB01D | GJM1555C1H9R9CB01D |
| | ±0.5pF(D) | GJM0336C1E9R9DB01D | GJM1555C1H9R9DB01D |

The part number code is shown in () and Unit is shown in []. < >: EIA [inch] Code

For General GRM Series

Array GNM Series

Low ESL LL□ Series

High-Q GJM Series

High Frequency GQM Series

Monolithic Microchip GMA Series

For Bonding GMD Series

Product Information

Temperature Compensating Type C0G(5C)/C0H(6C) Characteristics

| LxW [mm] | | 0.6x0.3(03)<0201> | | 1.0x0.5(15)<0402> |
|-------------------|-----------|--------------------|--------------------|--------------------|
| Rated Volt. [Vdc] | | 25(1E) | 6.3(0J) | 50(1H) |
| Capacitance | Tolerance | Part Number | | |
| 10pF(100) | ±2%(G) | GJM0336C1E100GB01D | | GJM1555C1H100GB01D |
| | ±5%(J) | GJM0336C1E100JB01D | | GJM1555C1H100JB01D |
| 11pF(110) | ±2%(G) | GJM0336C1E110GB01D | | GJM1555C1H110GB01D |
| | ±5%(J) | GJM0336C1E110JB01D | | GJM1555C1H110JB01D |
| 12pF(120) | ±2%(G) | GJM0336C1E120GB01D | | GJM1555C1H120GB01D |
| | ±5%(J) | GJM0336C1E120JB01D | | GJM1555C1H120JB01D |
| 13pF(130) | ±2%(G) | GJM0336C1E130GB01D | | GJM1555C1H130GB01D |
| | ±5%(J) | GJM0336C1E130JB01D | | GJM1555C1H130JB01D |
| 15pF(150) | ±2%(G) | GJM0336C1E150GB01D | | GJM1555C1H150GB01D |
| | ±5%(J) | GJM0336C1E150JB01D | | GJM1555C1H150JB01D |
| 16pF(160) | ±2%(G) | GJM0336C1E160GB01D | | GJM1555C1H160GB01D |
| | ±5%(J) | GJM0336C1E160JB01D | | GJM1555C1H160JB01D |
| 18pF(180) | ±2%(G) | GJM0336C1E180GB01D | | GJM1555C1H180GB01D |
| | ±5%(J) | GJM0336C1E180JB01D | | GJM1555C1H180JB01D |
| 20pF(200) | ±2%(G) | GJM0336C1E200GB01D | | GJM1555C1H200GB01D |
| | ±5%(J) | GJM0336C1E200JB01D | | GJM1555C1H200JB01D |
| 22pF(220) | ±2%(G) | | GJM0335C0J220GB01D | |
| | ±5%(J) | | GJM0335C0J220JB01D | |
| 24pF(240) | ±2%(G) | | GJM0335C0J240GB01D | |
| | ±5%(J) | | GJM0335C0J240JB01D | |
| 27pF(270) | ±2%(G) | | GJM0335C0J270GB01D | |
| | ±5%(J) | | GJM0335C0J270JB01D | |
| 30pF(300) | ±2%(G) | | GJM0335C0J300GB01D | |
| | ±5%(J) | | GJM0335C0J300JB01D | |
| 33pF(330) | ±2%(G) | | GJM0335C0J330GB01D | |
| | ±5%(J) | | GJM0335C0J330JB01D | |

The part number code is shown in () and Unit is shown in []. < >: EIA [inch] Code

(Part Number) GJ M 03 3 6C 1E 100 G B01 D

- ① Product ID
- ② Series
- ③ Dimensions (LxW)
- ④ Dimension (T)
- ⑤ Temperature Characteristics
- ⑥ Rated Voltage
- ⑦ Capacitance
- ⑧ Capacitance Tolerance
- ⑨ Individual Specification Code
- ⑩ Packaging

Packaging Code in Part Number shows STD 180mm Reel Taping.

GJM Series Specifications and Test Methods

| No. | Item | Specifications | | Test Method | | | | |
|-----------|---|---|--|---|-----------|----------|---------|--------------|
| | | Temperature Compensating Type | | | | | | |
| 1 | Operating Temperature Range | -55 to +125°C | | Reference Temperature: 25°C (2C, 3C, 4C: 20°C) | | | | |
| 2 | Rated Voltage | See the previous pages. | | The rated voltage is defined as the maximum voltage that may be applied continuously to the capacitor. When AC voltage is superimposed on DC voltage, V^{P-P} or V^{O-P} , whichever is larger, should be maintained within the rated voltage range. | | | | |
| 3 | Appearance | No defects or abnormalities | | Visual inspection | | | | |
| 4 | Dimensions | Within the specified dimensions | | Using calipers | | | | |
| 5 | Dielectric Strength | No defects or abnormalities | | No failure should be observed when 300% of the rated voltage is applied between the terminations for 1 to 5 seconds, provided the charge/discharge current is less than 50mA. | | | | |
| 6 | Insulation Resistance (I.R.) | 10,000MΩ min. or 500Ω · F min. (whichever is smaller) | | The insulation resistance should be measured with a DC voltage not exceeding the rated voltage at 25°C and 75%RH max. and within 2 minutes of charging. | | | | |
| 7 | Capacitance | Within the specified tolerance | | The capacitance/Q should be measured at 25°C at the frequency and voltage shown in the table. | | | | |
| 8 | Q | 30pF and over: $Q \geq 1000$ 30pF and below: $Q \geq 400 + 20C$ C: Nominal Capacitance (pF) | | <table border="1" style="margin-left: auto; margin-right: auto;"> <tr> <td>Frequency</td> <td>1±0.1MHz</td> </tr> <tr> <td>Voltage</td> <td>0.5 to 5Vrms</td> </tr> </table> | Frequency | 1±0.1MHz | Voltage | 0.5 to 5Vrms |
| Frequency | 1±0.1MHz | | | | | | | |
| Voltage | 0.5 to 5Vrms | | | | | | | |
| 9 | Capacitance Temperature Characteristics | Temperature Coefficient | Within the specified tolerance (Table A) | The capacitance change should be measured after 5 min. at each specified temperature stage. Temperature Compensating Type The temperature coefficient is determined using the capacitance measured in step 3 as a reference. When cycling the temperature sequentially from step 1 through 5, (5C: +25 to 125°C; other temp. coeffs.: +20 to 125°C) the capacitance should be within the specified tolerance for the temperature coefficient and capacitance change as in Table A. The capacitance drift is calculated by dividing the differences between the maximum and minimum measured values in steps 1, 3 and 5 by the capacitance value in step 3. | | | | |
| | | Capacitance Drift | Within ±0.2% or ±0.05pF (whichever is larger.) | | | | | |
| 10 | Adhesive Strength of Termination | No removal of the terminations or other defect should occur. | | Solder the capacitor to the test jig (glass epoxy board) shown in Fig. 1 using a eutectic solder. Then apply a 5N* force in parallel with the test jig for 10±1 sec. The soldering should be done either with an iron or using the reflow method and should be conducted with care so that the soldering is uniform and free of defects such as heat shock. *2N (GJM03) | | | | |

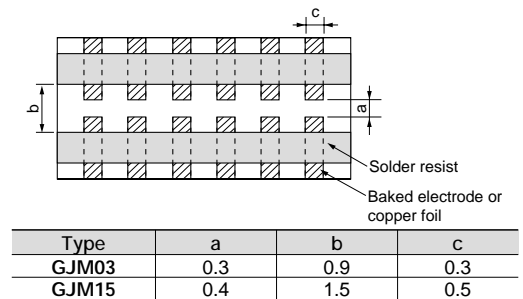

Fig. 1

Continued on the following page.

For General GRM Series

Array GNM Series

Low ESL LL□ Series

High-Q GJM Series

High Frequency GOM Series

Monolithic Microchip GMA Series

For Bonding GMD Series

Product Information

GJM Series Specifications and Test Methods

☐ Continued from the preceding page.

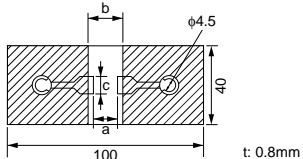
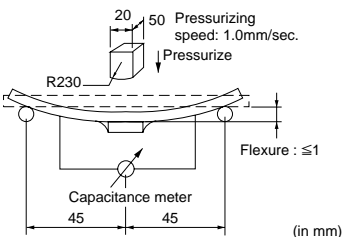
| No. | Item | Specifications | | Test Method | | | | | | | | | |
|--|--|--|--|---|--|---|---|---|-------|-----|-----|-----|-------|
| | | Temperature Compensating Type | | | | | | | | | | | |
| 11 | Vibration Resistance | Appearance | No defects or abnormalities | | Solder the capacitor to the test jig (glass epoxy board) in the same manner and under the same conditions as (10). The capacitor should be subjected to a simple harmonic motion having a total amplitude of 1.5mm, the frequency being varied uniformly between the approximate limits of 10 and 55Hz. The frequency range, from 10 to 55Hz and return to 10Hz, should be traversed in approximately 1 minute. This motion should be applied for a period of 2 hours in each of 3 mutually perpendicular directions (total of 6 hours). | | | | | | | | |
| | | Capacitance | Within the specified tolerance | | | | | | | | | | |
| | | Q | 30pF and over: $Q \geq 1000$ 30pF and below: $Q \geq 400+20C$ C: Nominal Capacitance (pF) | | | | | | | | | | |
| 12 | Deflection | Appearance | No marking defects | | Solder the capacitor to the test jig (glass epoxy boards) shown in Fig. 2 using a eutectic solder. Then apply a force in the direction shown in Fig. 3. The soldering should be done by the reflow method and should be conducted with care so that the soldering is uniform and free of defects such as heat shock. | | | | | | | | |
| | | Capacitance Change | Within $\pm 5\%$ or $\pm 0.5\text{pF}$ (whichever is larger) | | | | | | | | | | |
| | |  <table border="1" data-bbox="375 862 885 929"> <thead> <tr> <th>Type</th> <th>a</th> <th>b</th> <th>c</th> </tr> </thead> <tbody> <tr> <td>GJM03</td> <td>0.3</td> <td>0.9</td> <td>0.3</td> </tr> <tr> <td>GJM15</td> <td>0.4</td> <td>1.5</td> <td>0.5</td> </tr> </tbody> </table> <p style="text-align: center;">(in mm)</p> | | Type | | a | b | c | GJM03 | 0.3 | 0.9 | 0.3 | GJM15 |
| Type | a | b | c | | | | | | | | | | |
| GJM03 | 0.3 | 0.9 | 0.3 | | | | | | | | | | |
| GJM15 | 0.4 | 1.5 | 0.5 | | | | | | | | | | |
|  <p style="text-align: center;">(in mm)</p> | | | | | | | | | | | | | |
| 13 | Solderability of Termination | 75% of the terminations are to be soldered evenly and continuously. | | Immerse the capacitor in a solution of ethanol (JIS-K-8101) and rosin (JIS-K-5902) (25% rosin in weight proportion). Preheat at 80 to 120°C for 10 to 30 seconds. After preheating, immerse in eutectic solder solution for 2 ± 0.5 seconds at $230 \pm 5^\circ\text{C}$ or Sn-3.0Ag-0.5Cu solder solution for 2 ± 0.5 seconds at $245 \pm 5^\circ\text{C}$. | | | | | | | | | |
| 14 | Resistance to Soldering Heat | The measured and observed characteristics should satisfy the specifications in the following table. | | Preheat the capacitor at 120 to 150°C for 1 minute. Immerse the capacitor in a eutectic solder or Sn-3.0Ag-0.5Cu solder solution at $270 \pm 5^\circ\text{C}$ for 10 ± 0.5 seconds. Let sit at room temperature for 24 ± 2 hours. | | | | | | | | | |
| | | Appearance | No marking defects | | | | | | | | | | |
| | | Capacitance Change | Within $\pm 2.5\%$ or $\pm 0.25\text{pF}$ (whichever is larger) | | | | | | | | | | |
| | | Q | 30pF and over: $Q \geq 1000$ 30pF and below: $Q \geq 400+20C$ C: Nominal Capacitance (pF) | | | | | | | | | | |
| | | I.R. | More than 10,000M Ω or 500 $\Omega \cdot \text{F}$ (whichever is smaller) | | | | | | | | | | |
| 15 | Temperature Cycle | The measured and observed characteristics should satisfy the specifications in the following table. | | Fix the capacitor to the supporting jig in the same manner and under the same conditions as (10). Perform the five cycles according to the four heat treatments listed in the following table. Let sit for 24 ± 2 hours at room temperature, then measure. | | | | | | | | | |
| | | Appearance | No marking defects | | | | | | | | | | |
| | | Capacitance Change | Within $\pm 2.5\%$ or $\pm 0.25\text{pF}$ (whichever is larger) | | | | | | | | | | |
| | | Q | 30pF and over: $Q \geq 1000$ 30pF and below: $Q \geq 400+20C$ C: Nominal Capacitance (pF) | | | | | | | | | | |
| | | I.R. | More than 10,000M Ω or 500 $\Omega \cdot \text{F}$ (whichever is smaller) | | | | | | | | | | |
| 16 | Humidity, Steady State | The measured and observed characteristics should satisfy the specifications in the following table. | | Let the capacitor sit at $40 \pm 2^\circ\text{C}$ and 90 to 95% humidity for 500 ± 12 hours. Remove and let sit for 24 ± 2 hours (temperature compensating type) at room temperature, then measure. | | | | | | | | | |
| | | Appearance | No marking defects | | | | | | | | | | |
| | | Capacitance Change | Within $\pm 5\%$ or $\pm 0.5\text{pF}$ (whichever is larger) | | | | | | | | | | |
| | | Q | 30pF and below: $Q \geq 350$ 10pF and over, 30pF and below: $Q \geq 275 + \frac{5}{C}$ 10pF and below: $Q \geq 200+10C$ C: Nominal Capacitance (pF) | | | | | | | | | | |
| I.R. | More than 10,000M Ω or 500 $\Omega \cdot \text{F}$ (whichever is smaller) | | | | | | | | | | | | |

Continued on the following page. ☐

GJM Series Specifications and Test Methods

☐ Continued from the preceding page.

| No. | Item | Specifications | | Test Method |
|-----|-----------------------|---|---|---|
| | | Temperature Compensating Type | | |
| 17 | Humidity Load | The measured and observed characteristics should satisfy the specifications in the following table. | | Apply the rated voltage at 40±2°C and 90 to 95% humidity for 500±12 hours. Remove and let sit for 24±2 hours at room temperature, then measure. The charge/discharge current is less than 50mA. |
| | | Appearance | No marking defects | |
| | | Capacitance Change | Within ±7.5% or ±0.75pF (whichever is larger) | |
| | | Q | 30pF and over: Q≥200 30pF and below: Q≥100+ $\frac{1}{5}$ C C: Nominal Capacitance (pF) | |
| | I.R. | More than 500MΩ or 25Ω · F (whichever is smaller) | | |
| 18 | High Temperature Load | The measured and observed characteristics should satisfy the specifications in the following table. | | Apply 200% of the rated voltage for 1000±12 hours at the maximum operating temperature ±3°C. Let sit for 24±2 hours (temperature compensating type) at room temperature, then measure. The charge/discharge current is less than 50mA. |
| | | Appearance | No marking defects | |
| | | Capacitance Change | Within ±3% or ±0.3pF (whichever is larger) | |
| | | Q | 30pF and over: Q≥350 10pF and over, 30pF and below: Q≥275+ $\frac{5}{2}$ C 10pF and below: Q≥200+10C C: Nominal Capacitance (pF) | |
| | I.R. | More than 1,000MΩ or 50Ω · F (whichever is smaller) | | |
| 19 | ESR | 0.1pF<C≤1pF: 350mΩ · pF below 1pF<C≤5pF: 300mΩ below 5pF<C≤10pF: 250mΩ below | | The ESR should be measured at room temperature, and frequency 1±0.2GHz with the equivalent of BOONTON Model 34A. |
| | | 10pF<C≤33pF: 400mΩ below | | The ESR should be measured at room temperature, and frequency 500±50MHz with the equivalent of HP8753B. |

Table A
(1)

| Char. Code | Temp. Coeff. (ppm/°C) *1 | Capacitance Change from 25°C Value (%) | | | | | |
|------------|--------------------------|--|-------|-------|-------|-------|-------|
| | | -55°C | | -30°C | | -10°C | |
| | | Max. | Min. | Max. | Min. | Max. | Min. |
| 5C | 0±30 | 0.58 | -0.24 | 0.40 | -0.17 | 0.25 | -0.11 |
| 6C | 0±60 | 0.87 | -0.48 | 0.60 | -0.33 | 0.38 | -0.21 |

*1: Nominal values denote the temperature coefficient within a range of 25 to 125°C.

(2)

| Char. | Nominal Values (ppm/°C) *2 | Capacitance Change from 20°C Value (%) | | | | | |
|-------|----------------------------|--|-------|-------|-------|-------|-------|
| | | -55°C | | -25°C | | -10°C | |
| | | Max. | Min. | Max. | Min. | Max. | Min. |
| 2C | 0±60 | 0.82 | -0.45 | 0.49 | -0.27 | 0.33 | -0.18 |
| 3C | 0±120 | 1.37 | -0.90 | 0.82 | -0.54 | 0.55 | -0.36 |
| 4C | 0±250 | 2.56 | -1.88 | 1.54 | -1.13 | 1.02 | -0.75 |

*2: Nominal values denote the temperature coefficient within a range of 20 to 125°C.

For General GRM Series

Array GJM Series

Low ESL LL□ Series

High-Q GJM Series

High Frequency GOM Series

Monolithic Microchip GMA Series

For Bonding GMD Series

Product Information

Chip Monolithic Ceramic Capacitors



High Frequency GQM Series

■ Features

1. HiQ and low ESR at VHF, UHF, Microwave
2. Feature improvement, low power consumption for mobile telecommunication. (Base station, terminal, etc.)

■ Applications

High frequency circuit (Mobile telecommunication, etc.)

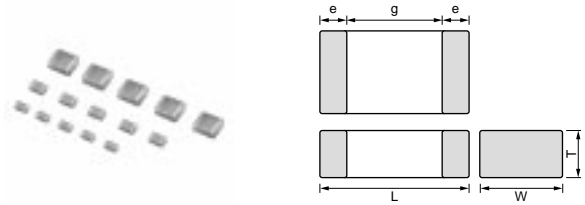

| Part Number | Dimensions (mm) | | | | |
|-------------------------|-----------------|------------|------------|------------|--------|
| | L | W | T | e | g min. |
| GQM187 | 1.6 ±0.15 | 0.8 ±0.15 | 0.7 ±0.1 | 0.2 to 0.5 | 0.5 |
| GQM188 | 1.6 ±0.1 | 0.8 ±0.1 | 0.8 ±0.1 | 0.2 to 0.5 | 0.5 |
| GQM219 (50,100V) | 2.0 ±0.1 | 1.25 ±0.1 | 0.85 ±0.1 | 0.2 to 0.7 | 0.7 |
| GQM219 (250V) | 2.0 ±0.15 | 1.25 ±0.15 | 0.85 ±0.15 | 0.2 to 0.7 | 0.7 |
| GQM22M | 2.8 ±0.5 | 2.8 ±0.4 | 1.15 ±0.2 | 0.3 min. | 1.0 |

For General
GRM Series

Array
GMM Series

Low ESL
LL□ Series

High-Q
GJM Series

High Frequency
GQM Series

Monolithic Microchip
GMA Series

For Bonding
GMD Series

Product Information

Capacitance Table

Temperature Compensating Type C0G(5C) Characteristics

| 7 | | ex.7: T Dimension [mm] | | | | | | |
|-------------|----------|------------------------|----------|----------|----------------------|----------|----------|---------------------|
| Capacitance | LxW [mm] | 1.6x0.8 (18) <0603> | | | 2.0x1.25 (21) <0805> | | | 2.0x2.5 (22) <0810> |
| | | Rated Voltage [Vdc] | 250 (2E) | 100 (2A) | 50 (1H) | 250 (2E) | 100 (2A) | 50 (1H) |
| 0.10pF(R10) | 7 | | | | | | | |
| 0.20pF(R20) | 7 | | | | | | | |
| 0.30pF(R30) | 7 | | | | | | | |
| 0.40pF(R40) | 7 | | | | | | | |
| 0.50pF(R50) | 7 | 8 | | 9 | 9 | | | M |
| 0.75pF(R75) | 7 | 8 | | 9 | 9 | | | M |
| 1.0pF(1R0) | 7 | 8 | | 9 | 9 | | | M |
| 1.1pF(1R1) | 7 | 8 | | 9 | 9 | | | M |
| 1.2pF(1R2) | 7 | 8 | | 9 | 9 | | | M |
| 1.3pF(1R3) | 7 | 8 | | 9 | 9 | | | M |
| 1.5pF(1R5) | 7 | 8 | | 9 | 9 | | | M |
| 1.6pF(1R6) | 7 | 8 | | 9 | 9 | | | M |
| 1.8pF(1R8) | 7 | 8 | | 9 | 9 | | | M |
| 2.0pF(2R0) | 7 | 8 | | 9 | 9 | | | M |
| 2.2pF(2R2) | 7 | 8 | | 9 | 9 | | | M |
| 2.4pF(2R4) | 7 | 8 | | 9 | 9 | | | M |
| 2.7pF(2R7) | 7 | 8 | | 9 | 9 | | | M |
| 3.0pF(3R0) | 7 | 8 | | 9 | 9 | | | M |
| 3.3pF(3R3) | 7 | 8 | | 9 | 9 | | | M |
| 3.6pF(3R6) | 7 | 8 | | 9 | 9 | | | M |
| 3.9pF(3R9) | 7 | 8 | | 9 | 9 | | | M |
| 4.0pF(4R0) | 7 | 8 | | 9 | 9 | | | M |
| 4.3pF(4R3) | 7 | 8 | | 9 | 9 | | | M |
| 4.7pF(4R7) | 7 | 8 | | 9 | 9 | | | M |
| 5.0pF(5R0) | 7 | 8 | | 9 | 9 | | | M |
| 5.1pF(5R1) | 7 | 8 | | 9 | 9 | | | M |
| 5.6pF(5R6) | 7 | 8 | | 9 | 9 | | | M |
| 6.0pF(6R0) | 7 | 8 | | 9 | 9 | | | M |
| 6.2pF(6R2) | 7 | 8 | | 9 | 9 | | | M |
| 6.8pF(6R8) | 7 | 8 | | 9 | 9 | | | M |
| 7.0pF(7R0) | 7 | | 8 | 9 | 9 | | | M |
| 7.5pF(7R5) | 7 | | 8 | 9 | 9 | | | M |
| 8.0pF(8R0) | 7 | | 8 | 9 | 9 | | | M |
| 8.2pF(8R2) | 7 | | 8 | 9 | 9 | | | M |
| 9.0pF(9R0) | 7 | | 8 | 9 | 9 | | | M |
| 9.1pF(9R1) | 7 | | 8 | 9 | 9 | | | M |
| 10pF(100) | 7 | | 8 | 9 | 9 | | | M |
| 11pF(110) | 7 | | 8 | 9 | 9 | | | M |
| 12pF(120) | 7 | | 8 | 9 | 9 | | | M |
| 13pF(130) | 7 | | 8 | 9 | 9 | | | M |
| 15pF(150) | 7 | | 8 | 9 | 9 | | | M |
| 16pF(160) | 7 | | 8 | 9 | 9 | | | M |
| 18pF(180) | 7 | | 8 | 9 | 9 | | | M |
| 20pF(200) | 7 | | 8 | 9 | | 9 | | M |
| 22pF(220) | 7 | | 8 | 9 | | 9 | | M |
| 24pF(240) | 7 | | 8 | 9 | | 9 | | M |
| 27pF(270) | 7 | | 8 | 9 | | 9 | | M |
| 30pF(300) | 7 | | 8 | 9 | | 9 | | M |
| 33pF(330) | 7 | | 8 | 9 | | 9 | | M |

| Capacitance | LxW [mm] | 1.6x0.8 (18) <0603> | | | 2.0x1.25 (21) <0805> | | | 2.0x2.5 (22) <0810> | |
|-------------|----------|---------------------|----------|----------|----------------------|----------|----------|---------------------|----------|
| | | Rated Voltage [Vdc] | 250 (2E) | 100 (2A) | 50 (1H) | 250 (2E) | 100 (2A) | 50 (1H) | 500 (2H) |
| 36pF(360) | 7 | | | 8 | 9 | | | 9 | M |
| 39pF(390) | 7 | | | 8 | 9 | | | 9 | M |
| 43pF(430) | 7 | | | 8 | 9 | | | 9 | M |
| 47pF(470) | 7 | | | 8 | 9 | | | 9 | M |
| 51pF(510) | | | | 8 | 9 | | | 9 | M |
| 56pF(560) | | | | 8 | 9 | | | 9 | M |
| 62pF(620) | | | | 8 | 9 | | | 9 | M |
| 68pF(680) | | | | 8 | 9 | | | 9 | M |
| 75pF(750) | | | | 8 | 9 | | | 9 | M |
| 82pF(820) | | | | 8 | 9 | | | 9 | M |
| 91pF(910) | | | | 8 | 9 | | | 9 | M |
| 100pF(101) | | | | 8 | 9 | | | 9 | M |

The part number code is shown in () and Unit is shown in []. < >: EIA [inch] Code

Temperature Compensating Type C0G(5C) Characteristics

| LxW [mm] | | 1.6x0.8(18)<0603> | |
|-------------------|------------|--------------------|--------------------|
| Rated Volt. [Vdc] | | 250(2E) | 100(2A) |
| Capacitance | Tolerance | Part Number | |
| 0.10pF(R10) | ±0.1pF(B) | GQM1875C2ER10BB12D | |
| 0.20pF(R20) | ±0.1pF(B) | GQM1875C2ER20BB12D | |
| 0.30pF(R30) | ±0.1pF(B) | GQM1875C2ER30BB12D | |
| | ±0.25pF(C) | GQM1875C2ER30CB12D | |
| 0.40pF(R40) | ±0.1pF(B) | GQM1875C2ER40BB12D | |
| | ±0.25pF(C) | GQM1875C2ER40CB12D | |
| 0.50pF(R50) | ±0.1pF(B) | GQM1875C2ER50BB12D | GQM1885C2AR50BB01D |
| | ±0.25pF(C) | GQM1875C2ER50CB12D | GQM1885C2AR50CB01D |
| 0.75pF(R75) | ±0.1pF(B) | GQM1875C2ER75BB12D | GQM1885C2AR75BB01D |
| | ±0.25pF(C) | GQM1875C2ER75CB12D | GQM1885C2AR75CB01D |
| 1.0pF(1R0) | ±0.1pF(B) | GQM1875C2E1R0BB12D | GQM1885C2A1R0BB01D |
| | ±0.25pF(C) | GQM1875C2E1R0CB12D | GQM1885C2A1R0CB01D |
| 1.1pF(1R1) | ±0.1pF(B) | GQM1875C2E1R1BB12D | GQM1885C2A1R1BB01D |
| | ±0.25pF(C) | GQM1875C2E1R1CB12D | GQM1885C2A1R1CB01D |
| 1.2pF(1R2) | ±0.1pF(B) | GQM1875C2E1R2BB12D | GQM1885C2A1R2BB01D |
| | ±0.25pF(C) | GQM1875C2E1R2CB12D | GQM1885C2A1R2CB01D |
| 1.3pF(1R3) | ±0.1pF(B) | GQM1875C2E1R3BB12D | GQM1885C2A1R3BB01D |
| | ±0.25pF(C) | GQM1875C2E1R3CB12D | GQM1885C2A1R3CB01D |
| 1.5pF(1R5) | ±0.1pF(B) | GQM1875C2E1R5BB12D | GQM1885C2A1R5BB01D |
| | ±0.25pF(C) | GQM1875C2E1R5CB12D | GQM1885C2A1R5CB01D |
| 1.6pF(1R6) | ±0.1pF(B) | GQM1875C2E1R6BB12D | GQM1885C2A1R6BB01D |
| | ±0.25pF(C) | GQM1875C2E1R6CB12D | GQM1885C2A1R6CB01D |
| 1.8pF(1R8) | ±0.1pF(B) | GQM1875C2E1R8BB12D | GQM1885C2A1R8BB01D |
| | ±0.25pF(C) | GQM1875C2E1R8CB12D | GQM1885C2A1R8CB01D |
| 2.0pF(2R0) | ±0.1pF(B) | GQM1875C2E2R0BB12D | GQM1885C2A2R0BB01D |
| | ±0.25pF(C) | GQM1875C2E2R0CB12D | GQM1885C2A2R0CB01D |
| 2.2pF(2R2) | ±0.1pF(B) | GQM1875C2E2R2BB12D | GQM1885C2A2R2BB01D |
| | ±0.25pF(C) | GQM1875C2E2R2CB12D | GQM1885C2A2R2CB01D |
| 2.4pF(2R4) | ±0.1pF(B) | GQM1875C2E2R4BB12D | GQM1885C2A2R4BB01D |
| | ±0.25pF(C) | GQM1875C2E2R4CB12D | GQM1885C2A2R4CB01D |
| 2.7pF(2R7) | ±0.1pF(B) | GQM1875C2E2R7BB12D | GQM1885C2A2R7BB01D |
| | ±0.25pF(C) | GQM1875C2E2R7CB12D | GQM1885C2A2R7CB01D |
| 3.0pF(3R0) | ±0.1pF(B) | GQM1875C2E3R0BB12D | GQM1885C2A3R0BB01D |
| | ±0.25pF(C) | GQM1875C2E3R0CB12D | GQM1885C2A3R0CB01D |
| 3.3pF(3R3) | ±0.1pF(B) | GQM1875C2E3R3BB12D | GQM1885C2A3R3BB01D |
| | ±0.25pF(C) | GQM1875C2E3R3CB12D | GQM1885C2A3R3CB01D |
| 3.6pF(3R6) | ±0.1pF(B) | GQM1875C2E3R6BB12D | GQM1885C2A3R6BB01D |
| | ±0.25pF(C) | GQM1875C2E3R6CB12D | GQM1885C2A3R6CB01D |
| 3.9pF(3R9) | ±0.1pF(B) | GQM1875C2E3R9BB12D | GQM1885C2A3R9BB01D |
| | ±0.25pF(C) | GQM1875C2E3R9CB12D | GQM1885C2A3R9CB01D |
| 4.0pF(4R0) | ±0.1pF(B) | GQM1875C2E4R0BB12D | GQM1885C2A4R0BB01D |
| | ±0.25pF(C) | GQM1875C2E4R0CB12D | GQM1885C2A4R0CB01D |
| 4.3pF(4R3) | ±0.1pF(B) | GQM1875C2E4R3BB12D | GQM1885C2A4R3BB01D |
| | ±0.25pF(C) | GQM1875C2E4R3CB12D | GQM1885C2A4R3CB01D |
| 4.7pF(4R7) | ±0.1pF(B) | GQM1875C2E4R7BB12D | GQM1885C2A4R7BB01D |
| | ±0.25pF(C) | GQM1875C2E4R7CB12D | GQM1885C2A4R7CB01D |
| 5.0pF(5R0) | ±0.1pF(B) | GQM1875C2E5R0BB12D | GQM1885C2A5R0BB01D |
| | ±0.25pF(C) | GQM1875C2E5R0CB12D | GQM1885C2A5R0CB01D |

The part number code is shown in () and Unit is shown in []. < >: EIA [inch] Code

- | | | | |
|---------------|---|---|--|
| (Part Number) | GQ M 18 7 5C 2E R10 B B12 D | ① Product ID ② Series ③ Dimensions (LxW) ④ Dimension (T) | ⑤ Temperature Characteristics ⑥ Rated Voltage ⑦ Capacitance ⑧ Capacitance Tolerance ⑨ Individual Specification Code ⑩ Packaging |
|---------------|---|---|--|

Packaging Code in Part Number shows STD 180mm Reel Taping.

Temperature Compensating Type C0G(5C) Characteristics

| LxW [mm] | | 1.6x0.8(18)<0603> | | |
|-------------------|------------|--------------------|--------------------|--------------------|
| Rated Volt. [Vdc] | | 250(2E) | 100(2A) | 50(1H) |
| Capacitance | Tolerance | Part Number | | |
| 5.1pF(5R1) | ±0.25pF(C) | GQM1875C2E5R1CB12D | GQM1885C2A5R1CB01D | |
| | ±0.5pF(D) | GQM1875C2E5R1DB12D | GQM1885C2A5R1DB01D | |
| 5.6pF(5R6) | ±0.25pF(C) | GQM1875C2E5R6CB12D | GQM1885C2A5R6CB01D | |
| | ±0.5pF(D) | GQM1875C2E5R6DB12D | GQM1885C2A5R6DB01D | |
| 6.0pF(6R0) | ±0.25pF(C) | GQM1875C2E6R0CB12D | GQM1885C2A6R0CB01D | |
| | ±0.5pF(D) | GQM1875C2E6R0DB12D | GQM1885C2A6R0DB01D | |
| 6.2pF(6R2) | ±0.25pF(C) | GQM1875C2E6R2CB12D | GQM1885C2A6R2CB01D | |
| | ±0.5pF(D) | GQM1875C2E6R2DB12D | GQM1885C2A6R2DB01D | |
| 6.8pF(6R8) | ±0.25pF(C) | GQM1875C2E6R8CB12D | GQM1885C2A6R8CB01D | |
| | ±0.5pF(D) | GQM1875C2E6R8DB12D | GQM1885C2A6R8DB01D | |
| 7.0pF(7R0) | ±0.25pF(C) | GQM1875C2E7R0CB12D | | GQM1885C1H7R0CB01D |
| | ±0.5pF(D) | GQM1875C2E7R0DB12D | | GQM1885C1H7R0DB01D |
| 7.5pF(7R5) | ±0.25pF(C) | GQM1875C2E7R5CB12D | | GQM1885C1H7R5CB01D |
| | ±0.5pF(D) | GQM1875C2E7R5DB12D | | GQM1885C1H7R5DB01D |
| 8.0pF(8R0) | ±0.25pF(C) | GQM1875C2E8R0CB12D | | GQM1885C1H8R0CB01D |
| | ±0.5pF(D) | GQM1875C2E8R0DB12D | | GQM1885C1H8R0DB01D |
| 8.2pF(8R2) | ±0.25pF(C) | GQM1875C2E8R2CB12D | | GQM1885C1H8R2CB01D |
| | ±0.5pF(D) | GQM1875C2E8R2DB12D | | GQM1885C1H8R2DB01D |
| 9.0pF(9R0) | ±0.25pF(C) | GQM1875C2E9R0CB12D | | GQM1885C1H9R0CB01D |
| | ±0.5pF(D) | GQM1875C2E9R0DB12D | | GQM1885C1H9R0DB01D |
| 9.1pF(9R1) | ±0.25pF(C) | GQM1875C2E9R1CB12D | | GQM1885C1H9R1CB01D |
| | ±0.5pF(D) | GQM1875C2E9R1DB12D | | GQM1885C1H9R1DB01D |
| 10pF(100) | ±2%(G) | GQM1875C2E100GB12D | | GQM1885C1H100GB01D |
| | ±5%(J) | GQM1875C2E100JB12D | | GQM1885C1H100JB01D |
| 11pF(110) | ±2%(G) | GQM1875C2E110GB12D | | GQM1885C1H110GB01D |
| | ±5%(J) | GQM1875C2E110JB12D | | GQM1885C1H110JB01D |
| 12pF(120) | ±2%(G) | GQM1875C2E120GB12D | | GQM1885C1H120GB01D |
| | ±5%(J) | GQM1875C2E120JB12D | | GQM1885C1H120JB01D |
| 13pF(130) | ±2%(G) | GQM1875C2E130GB12D | | GQM1885C1H130GB01D |
| | ±5%(J) | GQM1875C2E130JB12D | | GQM1885C1H130JB01D |
| 15pF(150) | ±2%(G) | GQM1875C2E150GB12D | | GQM1885C1H150GB01D |
| | ±5%(J) | GQM1875C2E150JB12D | | GQM1885C1H150JB01D |
| 16pF(160) | ±2%(G) | GQM1875C2E160GB12D | | GQM1885C1H160GB01D |
| | ±5%(J) | GQM1875C2E160JB12D | | GQM1885C1H160JB01D |
| 18pF(180) | ±2%(G) | GQM1875C2E180GB12D | | GQM1885C1H180GB01D |
| | ±5%(J) | GQM1875C2E180JB12D | | GQM1885C1H180JB01D |
| 20pF(200) | ±2%(G) | GQM1875C2E200GB12D | | GQM1885C1H200GB01D |
| | ±5%(J) | GQM1875C2E200JB12D | | GQM1885C1H200JB01D |
| 22pF(220) | ±2%(G) | GQM1875C2E220GB12D | | GQM1885C1H220GB01D |
| | ±5%(J) | GQM1875C2E220JB12D | | GQM1885C1H220JB01D |
| 24pF(240) | ±2%(G) | GQM1875C2E240GB12D | | GQM1885C1H240GB01D |
| | ±5%(J) | GQM1875C2E240JB12D | | GQM1885C1H240JB01D |
| 27pF(270) | ±2%(G) | GQM1875C2E270GB12D | | GQM1885C1H270GB01D |
| | ±5%(J) | GQM1875C2E270JB12D | | GQM1885C1H270JB01D |
| 30pF(300) | ±2%(G) | GQM1875C2E300GB12D | | GQM1885C1H300GB01D |
| | ±5%(J) | GQM1875C2E300JB12D | | GQM1885C1H300JB01D |

The part number code is shown in () and Unit is shown in []. < >: EIA [inch] Code

For General GRM Series

Array GNM Series

Low ESL LL□ Series

High-Q GJM Series

High Frequency GOM Series

Monolithic Microchip GMA Series

For Bonding GMD Series

Product Information

Temperature Compensating Type C0G(5C) Characteristics

| LxW [mm] | | 1.6x0.8(18)<0603> | |
|-------------------|-----------|--------------------|--------------------|
| Rated Volt. [Vdc] | | 250(2E) | 50(1H) |
| Capacitance | Tolerance | Part Number | |
| 33pF(330) | ±2%(G) | GQM1875C2E330GB12D | GQM1885C1H330GB01D |
| | ±5%(J) | GQM1875C2E330JB12D | GQM1885C1H330JB01D |
| 36pF(360) | ±2%(G) | GQM1875C2E360GB12D | GQM1885C1H360GB01D |
| | ±5%(J) | GQM1875C2E360JB12D | GQM1885C1H360JB01D |
| 39pF(390) | ±2%(G) | GQM1875C2E390GB12D | GQM1885C1H390GB01D |
| | ±5%(J) | GQM1875C2E390JB12D | GQM1885C1H390JB01D |
| 43pF(430) | ±2%(G) | GQM1875C2E430GB12D | GQM1885C1H430GB01D |
| | ±5%(J) | GQM1875C2E430JB12D | GQM1885C1H430JB01D |
| 47pF(470) | ±2%(G) | GQM1875C2E470GB12D | GQM1885C1H470GB01D |
| | ±5%(J) | GQM1875C2E470JB12D | GQM1885C1H470JB01D |
| 51pF(510) | ±2%(G) | | GQM1885C1H510GB01D |
| | ±5%(J) | | GQM1885C1H510JB01D |
| 56pF(560) | ±2%(G) | | GQM1885C1H560GB01D |
| | ±5%(J) | | GQM1885C1H560JB01D |
| 62pF(620) | ±2%(G) | | GQM1885C1H620GB01D |
| | ±5%(J) | | GQM1885C1H620JB01D |
| 68pF(680) | ±2%(G) | | GQM1885C1H680GB01D |
| | ±5%(J) | | GQM1885C1H680JB01D |
| 75pF(750) | ±2%(G) | | GQM1885C1H750GB01D |
| | ±5%(J) | | GQM1885C1H750JB01D |
| 82pF(820) | ±2%(G) | | GQM1885C1H820GB01D |
| | ±5%(J) | | GQM1885C1H820JB01D |
| 91pF(910) | ±2%(G) | | GQM1885C1H910GB01D |
| | ±5%(J) | | GQM1885C1H910JB01D |
| 100pF(101) | ±2%(G) | | GQM1885C1H101GB01D |
| | ±5%(J) | | GQM1885C1H101JB01D |

The part number code is shown in () and Unit is shown in []. < >: EIA [inch] Code

For General GRM Series

Array GNM Series

Low ESL LL□ Series

High-Q GJM Series

High Frequency GQM Series

Monolithic Microchip GMA Series

For Bonding GMD Series

Product Information

(Part Number) **G****Q** **M** **18** **7** **5C** **2E** **330** **G** **B12** **D** ①Product ID ②Series ③Dimensions (LxW) ④Dimension (T)
 ⑤Temperature Characteristics ⑥Rated Voltage ⑦Capacitance
 ⑧Capacitance Tolerance ⑨Individual Specification Code ⑩Packaging

Packaging Code in Part Number shows STD 180mm Reel Taping.

Temperature Compensating Type C0G(5C) Characteristics

| LxW [mm] | | 2.0x1.25(21)<0805> | | 2.8x2.8(22)<1111> |
|-------------------|------------|--------------------|--------------------|--------------------|
| Rated Volt. [Vdc] | | 250(2E) | 100(2A) | 500(2H) |
| Capacitance | Tolerance | Part Number | | |
| 0.50pF(50) | ±0.1pF(B) | GQM2195C2ER50BB12D | GQM2195C2AR50BB01D | GQM22M5C2HR50BB01L |
| | ±0.25pF(C) | GQM2195C2ER50CB12D | GQM2195C2AR50CB01D | GQM22M5C2HR50CB01L |
| 0.75pF(75) | ±0.1pF(B) | GQM2195C2ER75BB12D | GQM2195C2AR75BB01D | GQM22M5C2HR75BB01L |
| | ±0.25pF(C) | GQM2195C2ER75CB12D | GQM2195C2AR75CB01D | GQM22M5C2HR75CB01L |
| 1.0pF(10) | ±0.1pF(B) | GQM2195C2E1R0BB12D | GQM2195C2A1R0BB01D | GQM22M5C2H1R0BB01L |
| | ±0.25pF(C) | GQM2195C2E1R0CB12D | GQM2195C2A1R0CB01D | GQM22M5C2H1R0CB01L |
| 1.1pF(11) | ±0.1pF(B) | GQM2195C2E1R1BB12D | GQM2195C2A1R1BB01D | GQM22M5C2H1R1BB01L |
| | ±0.25pF(C) | GQM2195C2E1R1CB12D | GQM2195C2A1R1CB01D | GQM22M5C2H1R1CB01L |
| 1.2pF(12) | ±0.1pF(B) | GQM2195C2E1R2BB12D | GQM2195C2A1R2BB01D | GQM22M5C2H1R2BB01L |
| | ±0.25pF(C) | GQM2195C2E1R2CB12D | GQM2195C2A1R2CB01D | GQM22M5C2H1R2CB01L |
| 1.3pF(13) | ±0.1pF(B) | GQM2195C2E1R3BB12D | GQM2195C2A1R3BB01D | GQM22M5C2H1R3BB01L |
| | ±0.25pF(C) | GQM2195C2E1R3CB12D | GQM2195C2A1R3CB01D | GQM22M5C2H1R3CB01L |
| 1.5pF(15) | ±0.1pF(B) | GQM2195C2E1R5BB12D | GQM2195C2A1R5BB01D | GQM22M5C2H1R5BB01L |
| | ±0.25pF(C) | GQM2195C2E1R5CB12D | GQM2195C2A1R5CB01D | GQM22M5C2H1R5CB01L |
| 1.6pF(16) | ±0.1pF(B) | GQM2195C2E1R6BB12D | GQM2195C2A1R6BB01D | GQM22M5C2H1R6BB01L |
| | ±0.25pF(C) | GQM2195C2E1R6CB12D | GQM2195C2A1R6CB01D | GQM22M5C2H1R6CB01L |
| 1.8pF(18) | ±0.1pF(B) | GQM2195C2E1R8BB12D | GQM2195C2A1R8BB01D | GQM22M5C2H1R8BB01L |
| | ±0.25pF(C) | GQM2195C2E1R8CB12D | GQM2195C2A1R8CB01D | GQM22M5C2H1R8CB01L |
| 2.0pF(20) | ±0.1pF(B) | GQM2195C2E2R0BB12D | GQM2195C2A2R0BB01D | GQM22M5C2H2R0BB01L |
| | ±0.25pF(C) | GQM2195C2E2R0CB12D | GQM2195C2A2R0CB01D | GQM22M5C2H2R0CB01L |
| 2.2pF(22) | ±0.1pF(B) | GQM2195C2E2R2BB12D | GQM2195C2A2R2BB01D | GQM22M5C2H2R2BB01L |
| | ±0.25pF(C) | GQM2195C2E2R2CB12D | GQM2195C2A2R2CB01D | GQM22M5C2H2R2CB01L |
| 2.4pF(24) | ±0.1pF(B) | GQM2195C2E2R4BB12D | GQM2195C2A2R4BB01D | GQM22M5C2H2R4BB01L |
| | ±0.25pF(C) | GQM2195C2E2R4CB12D | GQM2195C2A2R4CB01D | GQM22M5C2H2R4CB01L |
| 2.7pF(27) | ±0.1pF(B) | GQM2195C2E2R7BB12D | GQM2195C2A2R7BB01D | GQM22M5C2H2R7BB01L |
| | ±0.25pF(C) | GQM2195C2E2R7CB12D | GQM2195C2A2R7CB01D | GQM22M5C2H2R7CB01L |
| 3.0pF(30) | ±0.1pF(B) | GQM2195C2E3R0BB12D | GQM2195C2A3R0BB01D | GQM22M5C2H3R0BB01L |
| | ±0.25pF(C) | GQM2195C2E3R0CB12D | GQM2195C2A3R0CB01D | GQM22M5C2H3R0CB01L |
| 3.3pF(33) | ±0.1pF(B) | GQM2195C2E3R3BB12D | GQM2195C2A3R3BB01D | GQM22M5C2H3R3BB01L |
| | ±0.25pF(C) | GQM2195C2E3R3CB12D | GQM2195C2A3R3CB01D | GQM22M5C2H3R3CB01L |
| 3.6pF(36) | ±0.1pF(B) | GQM2195C2E3R6BB12D | GQM2195C2A3R6BB01D | GQM22M5C2H3R6BB01L |
| | ±0.25pF(C) | GQM2195C2E3R6CB12D | GQM2195C2A3R6CB01D | GQM22M5C2H3R6CB01L |
| 3.9pF(39) | ±0.1pF(B) | GQM2195C2E3R9BB12D | GQM2195C2A3R9BB01D | GQM22M5C2H3R9BB01L |
| | ±0.25pF(C) | GQM2195C2E3R9CB12D | GQM2195C2A3R9CB01D | GQM22M5C2H3R9CB01L |
| 4.0pF(40) | ±0.1pF(B) | GQM2195C2E4R0BB12D | GQM2195C2A4R0BB01D | GQM22M5C2H4R0BB01L |
| | ±0.25pF(C) | GQM2195C2E4R0CB12D | GQM2195C2A4R0CB01D | GQM22M5C2H4R0CB01L |
| 4.3pF(43) | ±0.1pF(B) | GQM2195C2E4R3BB12D | GQM2195C2A4R3BB01D | GQM22M5C2H4R3BB01L |
| | ±0.25pF(C) | GQM2195C2E4R3CB12D | GQM2195C2A4R3CB01D | GQM22M5C2H4R3CB01L |
| 4.7pF(47) | ±0.1pF(B) | GQM2195C2E4R7BB12D | GQM2195C2A4R7BB01D | GQM22M5C2H4R7BB01L |
| | ±0.25pF(C) | GQM2195C2E4R7CB12D | GQM2195C2A4R7CB01D | GQM22M5C2H4R7CB01L |
| 5.0pF(50) | ±0.1pF(B) | GQM2195C2E5R0BB12D | GQM2195C2A5R0BB01D | GQM22M5C2H5R0BB01L |
| | ±0.25pF(C) | GQM2195C2E5R0CB12D | GQM2195C2A5R0CB01D | GQM22M5C2H5R0CB01L |
| 5.1pF(51) | ±0.25pF(C) | GQM2195C2E5R1CB12D | GQM2195C2A5R1CB01D | GQM22M5C2H5R1CB01L |
| | ±0.5pF(D) | GQM2195C2E5R1DB12D | GQM2195C2A5R1DB01D | GQM22M5C2H5R1DB01L |
| 5.6pF(56) | ±0.25pF(C) | GQM2195C2E5R6CB12D | GQM2195C2A5R6CB01D | GQM22M5C2H5R6CB01L |
| | ±0.5pF(D) | GQM2195C2E5R6DB12D | GQM2195C2A5R6DB01D | GQM22M5C2H5R6DB01L |
| 6.0pF(60) | ±0.25pF(C) | GQM2195C2E6R0CB12D | GQM2195C2A6R0CB01D | GQM22M5C2H6R0CB01L |
| | ±0.5pF(D) | GQM2195C2E6R0DB12D | GQM2195C2A6R0DB01D | GQM22M5C2H6R0DB01L |

The part number code is shown in () and Unit is shown in []. < >: EIA [inch] Code

For General GRM Series

Array GNM Series

Low ESL LL□ Series

High-Q GJM Series

High Frequency GOM Series

Monolithic Microchip GMA Series

For Bonding GMD Series

Product Information

Temperature Compensating Type C0G(5C) Characteristics

| LxW [mm] | | 2.0x1.25(21)<0805> | | | 2.8x2.8(22)<1111> |
|-------------------|------------|--------------------|--------------------|--------------------|--------------------|
| Rated Volt. [Vdc] | | 250(2E) | 100(2A) | 50(1H) | 500(2H) |
| Capacitance | Tolerance | Part Number | | | |
| 6.2pF(6R2) | ±0.25pF(C) | GQM2195C2E6R2CB12D | GQM2195C2A6R2CB01D | | GQM22M5C2H6R2CB01L |
| | ±0.5pF(D) | GQM2195C2E6R2DB12D | GQM2195C2A6R2DB01D | | GQM22M5C2H6R2DB01L |
| 6.8pF(6R8) | ±0.25pF(C) | GQM2195C2E6R8CB12D | GQM2195C2A6R8CB01D | | GQM22M5C2H6R8CB01L |
| | ±0.5pF(D) | GQM2195C2E6R8DB12D | GQM2195C2A6R8DB01D | | GQM22M5C2H6R8DB01L |
| 7.0pF(7R0) | ±0.25pF(C) | GQM2195C2E7R0CB12D | GQM2195C2A7R0CB01D | | GQM22M5C2H7R0CB01L |
| | ±0.5pF(D) | GQM2195C2E7R0DB12D | GQM2195C2A7R0DB01D | | GQM22M5C2H7R0DB01L |
| 7.5pF(7R5) | ±0.25pF(C) | GQM2195C2E7R5CB12D | GQM2195C2A7R5CB01D | | GQM22M5C2H7R5CB01L |
| | ±0.5pF(D) | GQM2195C2E7R5DB12D | GQM2195C2A7R5DB01D | | GQM22M5C2H7R5DB01L |
| 8.0pF(8R0) | ±0.25pF(C) | GQM2195C2E8R0CB12D | GQM2195C2A8R0CB01D | | GQM22M5C2H8R0CB01L |
| | ±0.5pF(D) | GQM2195C2E8R0DB12D | GQM2195C2A8R0DB01D | | GQM22M5C2H8R0DB01L |
| 8.2pF(8R2) | ±0.25pF(C) | GQM2195C2E8R2CB12D | GQM2195C2A8R2CB01D | | GQM22M5C2H8R2CB01L |
| | ±0.5pF(D) | GQM2195C2E8R2DB12D | GQM2195C2A8R2DB01D | | GQM22M5C2H8R2DB01L |
| 9.0pF(9R0) | ±0.25pF(C) | GQM2195C2E9R0CB12D | GQM2195C2A9R0CB01D | | GQM22M5C2H9R0CB01L |
| | ±0.5pF(D) | GQM2195C2E9R0DB12D | GQM2195C2A9R0DB01D | | GQM22M5C2H9R0DB01L |
| 9.1pF(9R1) | ±0.25pF(C) | GQM2195C2E9R1CB12D | GQM2195C2A9R1CB01D | | GQM22M5C2H9R1CB01L |
| | ±0.5pF(D) | GQM2195C2E9R1DB12D | GQM2195C2A9R1DB01D | | GQM22M5C2H9R1DB01L |
| 10pF(100) | ±2%(G) | GQM2195C2E100GB12D | GQM2195C2A100GB01D | | GQM22M5C2H100GB01L |
| | ±5%(J) | GQM2195C2E100JB12D | GQM2195C2A100JB01D | | GQM22M5C2H100JB01L |
| 11pF(110) | ±2%(G) | GQM2195C2E110GB12D | GQM2195C2A110GB01D | | GQM22M5C2H110GB01L |
| | ±5%(J) | GQM2195C2E110JB12D | GQM2195C2A110JB01D | | GQM22M5C2H110JB01L |
| 12pF(120) | ±2%(G) | GQM2195C2E120GB12D | GQM2195C2A120GB01D | | GQM22M5C2H120GB01L |
| | ±5%(J) | GQM2195C2E120JB12D | GQM2195C2A120JB01D | | GQM22M5C2H120JB01L |
| 13pF(130) | ±2%(G) | GQM2195C2E130GB12D | GQM2195C2A130GB01D | | GQM22M5C2H130GB01L |
| | ±5%(J) | GQM2195C2E130JB12D | GQM2195C2A130JB01D | | GQM22M5C2H130JB01L |
| 15pF(150) | ±2%(G) | GQM2195C2E150GB12D | GQM2195C2A150GB01D | | GQM22M5C2H150GB01L |
| | ±5%(J) | GQM2195C2E150JB12D | GQM2195C2A150JB01D | | GQM22M5C2H150JB01L |
| 16pF(160) | ±2%(G) | GQM2195C2E160GB12D | GQM2195C2A160GB01D | | GQM22M5C2H160GB01L |
| | ±5%(J) | GQM2195C2E160JB12D | GQM2195C2A160JB01D | | GQM22M5C2H160JB01L |
| 18pF(180) | ±2%(G) | GQM2195C2E180GB12D | GQM2195C2A180GB01D | | GQM22M5C2H180GB01L |
| | ±5%(J) | GQM2195C2E180JB12D | GQM2195C2A180JB01D | | GQM22M5C2H180JB01L |
| 20pF(200) | ±2%(G) | GQM2195C2E200GB12D | | GQM2195C1H200GB01D | GQM22M5C2H200GB01L |
| | ±5%(J) | GQM2195C2E200JB12D | | GQM2195C1H200JB01D | GQM22M5C2H200JB01L |
| 22pF(220) | ±2%(G) | GQM2195C2E220GB12D | | GQM2195C1H220GB01D | GQM22M5C2H220GB01L |
| | ±5%(J) | GQM2195C2E220JB12D | | GQM2195C1H220JB01D | GQM22M5C2H220JB01L |
| 24pF(240) | ±2%(G) | GQM2195C2E240GB12D | | GQM2195C1H240GB01D | GQM22M5C2H240GB01L |
| | ±5%(J) | GQM2195C2E240JB12D | | GQM2195C1H240JB01D | GQM22M5C2H240JB01L |
| 27pF(270) | ±2%(G) | GQM2195C2E270GB12D | | GQM2195C1H270GB01D | GQM22M5C2H270GB01L |
| | ±5%(J) | GQM2195C2E270JB12D | | GQM2195C1H270JB01D | GQM22M5C2H270JB01L |
| 30pF(300) | ±2%(G) | GQM2195C2E300GB12D | | GQM2195C1H300GB01D | GQM22M5C2H300GB01L |
| | ±5%(J) | GQM2195C2E300JB12D | | GQM2195C1H300JB01D | GQM22M5C2H300JB01L |
| 33pF(330) | ±2%(G) | GQM2195C2E330GB12D | | GQM2195C1H330GB01D | GQM22M5C2H330GB01L |
| | ±5%(J) | GQM2195C2E330JB12D | | GQM2195C1H330JB01D | GQM22M5C2H330JB01L |
| 36pF(360) | ±2%(G) | GQM2195C2E360GB12D | | GQM2195C1H360GB01D | GQM22M5C2H360GB01L |
| | ±5%(J) | GQM2195C2E360JB12D | | GQM2195C1H360JB01D | GQM22M5C2H360JB01L |
| 39pF(390) | ±2%(G) | GQM2195C2E390GB12D | | GQM2195C1H390GB01D | GQM22M5C2H390GB01L |
| | ±5%(J) | GQM2195C2E390JB12D | | GQM2195C1H390JB01D | GQM22M5C2H390JB01L |

The part number code is shown in () and Unit is shown in []. < >: EIA [inch] Code

(Part Number) **GQ** **M** **21** **9** **5C** **2E** **6R2** **C** **B12** **D** **1** **2** **3** **4** **5** **6** **7** **8** **9** **10** **1** **2** **3** **4** **5** **6** **7** **8** **9** **10**

① Product ID ② Series ③ Dimensions (LxW) ④ Dimension (T)
 ⑤ Temperature Characteristics ⑥ Rated Voltage ⑦ Capacitance
 ⑧ Capacitance Tolerance ⑨ Individual Specification Code ⑩ Packaging

Packaging Code in Part Number shows STD 180mm Reel Taping.

Temperature Compensating Type C0G(5C) Characteristics

| LxW [mm] | | 2.0x1.25(21)<0805> | | 2.8x2.8(22)<1111> |
|-------------------|-----------|--------------------|--------------------|--------------------|
| Rated Volt. [Vdc] | | 250(2E) | 50(1H) | 500(2H) |
| Capacitance | Tolerance | Part Number | | |
| 43pF(430) | ±2%(G) | GQM2195C2E430GB12D | GQM2195C1H430GB01D | GQM22M5C2H430GB01L |
| | ±5%(J) | GQM2195C2E430JB12D | GQM2195C1H430JB01D | GQM22M5C2H430JB01L |
| 47pF(470) | ±2%(G) | GQM2195C2E470GB12D | GQM2195C1H470GB01D | GQM22M5C2H470GB01L |
| | ±5%(J) | GQM2195C2E470JB12D | GQM2195C1H470JB01D | GQM22M5C2H470JB01L |
| 51pF(510) | ±2%(G) | GQM2195C2E510GB12D | GQM2195C1H510GB01D | GQM22M5C2H510GB01L |
| | ±5%(J) | GQM2195C2E510JB12D | GQM2195C1H510JB01D | GQM22M5C2H510JB01L |
| 56pF(560) | ±2%(G) | GQM2195C2E560GB12D | GQM2195C1H560GB01D | GQM22M5C2H560GB01L |
| | ±5%(J) | GQM2195C2E560JB12D | GQM2195C1H560JB01D | GQM22M5C2H560JB01L |
| 62pF(620) | ±2%(G) | GQM2195C2E620GB12D | GQM2195C1H620GB01D | GQM22M5C2H620GB01L |
| | ±5%(J) | GQM2195C2E620JB12D | GQM2195C1H620JB01D | GQM22M5C2H620JB01L |
| 68pF(680) | ±2%(G) | GQM2195C2E680GB12D | GQM2195C1H680GB01D | GQM22M5C2H680GB01L |
| | ±5%(J) | GQM2195C2E680JB12D | GQM2195C1H680JB01D | GQM22M5C2H680JB01L |
| 75pF(750) | ±2%(G) | GQM2195C2E750GB12D | GQM2195C1H750GB01D | GQM22M5C2H750GB01L |
| | ±5%(J) | GQM2195C2E750JB12D | GQM2195C1H750JB01D | GQM22M5C2H750JB01L |
| 82pF(820) | ±2%(G) | GQM2195C2E820GB12D | GQM2195C1H820GB01D | GQM22M5C2H820GB01L |
| | ±5%(J) | GQM2195C2E820JB12D | GQM2195C1H820JB01D | GQM22M5C2H820JB01L |
| 91pF(910) | ±2%(G) | GQM2195C2E910GB12D | GQM2195C1H910GB01D | GQM22M5C2H910GB01L |
| | ±5%(J) | GQM2195C2E910JB12D | GQM2195C1H910JB01D | GQM22M5C2H910JB01L |
| 100pF(101) | ±2%(G) | GQM2195C2E101GB12D | GQM2195C1H101GB01D | GQM22M5C2H101GB01L |
| | ±5%(J) | GQM2195C2E101JB12D | GQM2195C1H101JB01D | GQM22M5C2H101JB01L |

The part number code is shown in () and Unit is shown in []. < >: EIA [inch] Code

For General
GRM Series

Array
GMM Series

Low ESL
LL□ Series

High-Q
GJM Series

High Frequency
GOM Series

Monolithic Microchip
GMA Series

For Bonding
GMD Series

Product Information

GQM Series Specifications and Test Methods

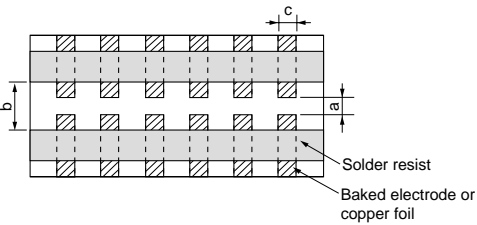
| No. | Item | Specifications | Test Method | | | | | | | | | | | | | | | | |
|---|---|---|---|------|------------------|---|-------------------------|-------|-------------|-----|-------------------------|-------|-------------|-----|-------------------------|-------|-----|-----|-----|
| 1 | Operating Temperature | -55 to 125°C | Reference Temperature: 25°C | | | | | | | | | | | | | | | | |
| 2 | Rated Voltage | See the previous page. | The rated voltage is defined as the maximum voltage that may be applied continuously to the capacitor. When AC voltage is superimposed on DC voltage, V^{P-P} or V^{O-P} , whichever is larger, should be maintained within the rated voltage range. | | | | | | | | | | | | | | | | |
| 3 | Appearance | No defects or abnormalities | Visual inspection | | | | | | | | | | | | | | | | |
| 4 | Dimension | Within the specified dimensions | Using calipers | | | | | | | | | | | | | | | | |
| 5 | Dielectric Strength | No defects or abnormalities | No failure should be observed when 300%* of the rated voltage is applied between the terminations for 1 to 5 seconds, provided the charge/discharge current is less than 50mA. *GQM187, GQM219(250V), GQM22: 250% of the rated voltage | | | | | | | | | | | | | | | | |
| 6 | Insulation Resistance | More than 10,000MΩ | The insulation resistance should be measured with a DC voltage not exceeding the rated voltage at 25°C and 75%RH max. and within 2 minutes of charging, provided the charge/discharge current is less than 50mA. | | | | | | | | | | | | | | | | |
| 7 | Capacitance | Within the specified tolerance | The capacitance/Q should be measured at 25°C at the frequency and voltage shown in the table. | | | | | | | | | | | | | | | | |
| 8 | Q | 30pF and over: $Q \geq 1400$ 30pF and below: $Q \geq 800+20C$ C: Nominal Capacitance (pF) | | | | | | | | | | | | | | | | | |
| 9 | Capacitance Temperature Characteristics | Temperature Coefficient | Within the specified tolerance (Table A) | | | | | | | | | | | | | | | | |
| | | Capacitance Drift | Within $\pm 0.2\%$ or $\pm 0.05\text{pF}$ (whichever is larger) | | | | | | | | | | | | | | | | |
| | | | <p>The capacitance change should be measured after 5 min. at each specified temp. stage.</p> <p>The temperature coefficient is determined using the capacitance measured in step 3 as a reference.</p> <p>When cycling the temperature sequentially from steps 1 through 5 the capacitance should be within the specified tolerance for the temperature coefficient and capacitance change as in Table A. The capacitance drift is calculated by dividing the differences between the maximum and minimum measured values in the steps 1, 3 and 5 by the capacitance value in step 3.</p> <table border="1" style="margin-left: auto; margin-right: auto;"> <thead> <tr> <th>Step</th> <th>Temperature (°C)</th> </tr> </thead> <tbody> <tr> <td>1</td> <td>Reference Temp. ± 2</td> </tr> <tr> <td>2</td> <td>-55± 3</td> </tr> <tr> <td>3</td> <td>Reference Temp. ± 2</td> </tr> <tr> <td>4</td> <td>125± 3</td> </tr> <tr> <td>5</td> <td>Reference Temp. ± 2</td> </tr> </tbody> </table> | Step | Temperature (°C) | 1 | Reference Temp. ± 2 | 2 | -55 ± 3 | 3 | Reference Temp. ± 2 | 4 | 125 ± 3 | 5 | Reference Temp. ± 2 | | | | |
| Step | Temperature (°C) | | | | | | | | | | | | | | | | | | |
| 1 | Reference Temp. ± 2 | | | | | | | | | | | | | | | | | | |
| 2 | -55 ± 3 | | | | | | | | | | | | | | | | | | |
| 3 | Reference Temp. ± 2 | | | | | | | | | | | | | | | | | | |
| 4 | 125 ± 3 | | | | | | | | | | | | | | | | | | |
| 5 | Reference Temp. ± 2 | | | | | | | | | | | | | | | | | | |
| 10 | Adhesive Strength of Termination | No removal of the terminations or other defect should occur. | <p>Solder the capacitor to the test jig (glass epoxy board) shown in Fig. 1 using a eutectic solder. Then apply 10N* force in parallel with the test jig for 10\pm1 sec.</p> <p>The soldering should be done either with an iron or using the reflow method and should be conducted with care so that the soldering is uniform and free of defects such as heat shock.</p> <p style="text-align: right;">*5N (GQM188)</p> <table border="1" style="margin-left: auto; margin-right: auto;"> <thead> <tr> <th>Type</th> <th>a</th> <th>b</th> <th>c</th> </tr> </thead> <tbody> <tr> <td>GQM18</td> <td>1.0</td> <td>3.0</td> <td>1.2</td> </tr> <tr> <td>GQM21</td> <td>1.2</td> <td>4.0</td> <td>1.65</td> </tr> <tr> <td>GQM22</td> <td>2.2</td> <td>5.0</td> <td>2.9</td> </tr> </tbody> </table> <p style="text-align: right;">(in mm)</p> | Type | a | b | c | GQM18 | 1.0 | 3.0 | 1.2 | GQM21 | 1.2 | 4.0 | 1.65 | GQM22 | 2.2 | 5.0 | 2.9 |
| | | Type | | a | b | c | | | | | | | | | | | | | |
| GQM18 | 1.0 | 3.0 | 1.2 | | | | | | | | | | | | | | | | |
| GQM21 | 1.2 | 4.0 | 1.65 | | | | | | | | | | | | | | | | |
| GQM22 | 2.2 | 5.0 | 2.9 | | | | | | | | | | | | | | | | |
|  | | <p>Fig. 1</p> | | | | | | | | | | | | | | | | | |
| 11 | Vibration Resistance | Appearance | No defects or abnormalities | | | | | | | | | | | | | | | | |
| | | Capacitance | Within the specified tolerance | | | | | | | | | | | | | | | | |
| | | | <p>Solder the capacitor to the test jig (glass epoxy board) in the same manner and under the same conditions as (10).</p> <p>The capacitor should be subjected to a simple harmonic motion having a total amplitude of 1.5mm, the frequency being varied uniformly between the approximate limits of 10 and 55Hz. The frequency range, from 10 to 55Hz and return to 10Hz, should be traversed in approximately 1 minute.</p> <p>This motion should be applied for a period of 2 hours in each of 3 mutually perpendicular directions (total of 6 hours).</p> | | | | | | | | | | | | | | | | |
| | | Q | <p>30pF and over: $Q \geq 1400$ 30pF and below: $Q \geq 800+20C$ C: Nominal Capacitance (pF)</p> | | | | | | | | | | | | | | | | |

Continued on the following page. ↗

GQM Series Specifications and Test Methods

Continued from the preceding page.

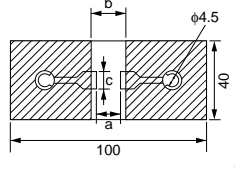
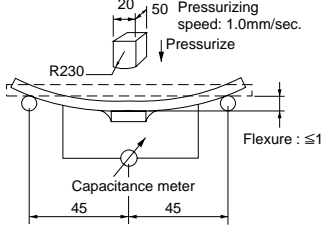
| No. | Item | Specifications | Test Method | | | | | | | | | | | | | | | |
|-------|------------------------------|--|---|---|---|---|-------|-----|-----|-----|-------|-----|-----|------|-------|-----|-----|-----|
| 12 | Appearance | No defects or abnormalities. | Solder the capacitor on the test jig (glass epoxy board) shown in Fig. 2 using a eutectic solder. Then apply a force in the direction shown in Fig. 3. The soldering should be done by the reflow method and should be conducted with care so that the soldering is uniform and free of defects such as heat shock. | | | | | | | | | | | | | | | |
| | Capacitance Change | Within $\pm 5\%$ or $\pm 0.5\text{pF}$ (whichever is larger) | | | | | | | | | | | | | | | | |
| | |  <table border="1" style="margin-left: auto; margin-right: auto;"> <thead> <tr> <th>Type</th> <th>a</th> <th>b</th> <th>c</th> </tr> </thead> <tbody> <tr> <td>GQM18</td> <td>1.0</td> <td>3.0</td> <td>1.2</td> </tr> <tr> <td>GQM21</td> <td>1.2</td> <td>4.0</td> <td>1.65</td> </tr> <tr> <td>GQM22</td> <td>2.2</td> <td>5.0</td> <td>2.9</td> </tr> </tbody> </table> <p style="text-align: center;">(in mm)</p> | Type | a | b | c | GQM18 | 1.0 | 3.0 | 1.2 | GQM21 | 1.2 | 4.0 | 1.65 | GQM22 | 2.2 | 5.0 | 2.9 |
| Type | a | b | c | | | | | | | | | | | | | | | |
| GQM18 | 1.0 | 3.0 | 1.2 | | | | | | | | | | | | | | | |
| GQM21 | 1.2 | 4.0 | 1.65 | | | | | | | | | | | | | | | |
| GQM22 | 2.2 | 5.0 | 2.9 | | | | | | | | | | | | | | | |
| | | Fig. 2 |  <p style="text-align: center;">Fig. 3</p> | | | | | | | | | | | | | | | |
| 13 | Solderability of Termination | 75% of the terminations are to be soldered evenly and continuously. | Immerse the capacitor in a solution of ethanol (JIS-K-8101) and rosin (JIS-K-5902) (25% rosin in weight proportion). Preheat at 80 to 120°C for 10 to 30 seconds. After preheating, immerse in eutectic solder solution for 2 ± 0.5 seconds at $230\pm 5^\circ\text{C}$ or Sn-3.0Ag-0.5Cu solder solution for 2 ± 0.5 seconds at $245\pm 5^\circ\text{C}$. | | | | | | | | | | | | | | | |
| 14 | | The measured and observed characteristics should satisfy the specifications in the following table. | Preheat the capacitor at 120 to 150°C for 1 minute. Immerse the capacitor in a eutectic solder or Sn-3.0Ag-0.5Cu solder solution at $270\pm 5^\circ\text{C}$ for 10 ± 0.5 seconds. Let sit at room temperature for 24 ± 2 hours, then measure. | | | | | | | | | | | | | | | |
| | Appearance | No defects or abnormalities. | | | | | | | | | | | | | | | | |
| | Capacitance Change | Within $\pm 2.5\%$ or $\pm 0.25\text{pF}$ (whichever is larger) | | | | | | | | | | | | | | | | |
| | Q | 30pF and over: $Q\geq 1400$ 30pF and below: $Q\geq 800+20C$ C: Nominal Capacitance (pF) | | | | | | | | | | | | | | | | |
| | I.R. | More than 10,000MΩ | | | | | | | | | | | | | | | | |
| | Dielectric Strength | No defects. | | | | | | | | | | | | | | | | |
| 15 | | The measured and observed characteristics should satisfy the specifications in the following table. | Fix the capacitor to the supporting jig in the same manner and under the same conditions as (10). Perform the five cycles according to the four heat treatments listed in the following table. Let sit for 24 ± 2 hours at room temperature, then measure. | | | | | | | | | | | | | | | |
| | Appearance | No defects or abnormalities. | | | | | | | | | | | | | | | | |
| | Capacitance Change | Within $\pm 2.5\%$ or $\pm 0.25\text{pF}$ (whichever is larger) | | | | | | | | | | | | | | | | |
| | Q | 30pF and over: $Q\geq 1400$ 30pF and below: $Q\geq 800+20C$ C: Nominal Capacitance (pF) | | | | | | | | | | | | | | | | |
| | I.R. | More than 10,000MΩ | | | | | | | | | | | | | | | | |
| | Dielectric Strength | No defects. | | | | | | | | | | | | | | | | |
| 16 | | The measured and observed characteristics should satisfy the specifications in the following table. | Set the capacitor at $40\pm 2^\circ\text{C}$ and in 90 to 95% humidity for 500 ± 12 hours. Remove and set for 24 ± 2 hours at room temperature, then measure. | | | | | | | | | | | | | | | |
| | Appearance | No defects or abnormalities. | | | | | | | | | | | | | | | | |
| | Capacitance Change | Within $\pm 5\%$ or $\pm 0.5\text{pF}$ (whichever is larger) | | | | | | | | | | | | | | | | |
| | Q | 30pF and over: $Q\geq 350$ 10pF and over, 30pF and below: $Q\geq 275+5C/2$ 10pF and below: $Q\geq 200+10C$ C: Nominal Capacitance (pF) | | | | | | | | | | | | | | | | |
| | I.R. | More than 1,000MΩ | | | | | | | | | | | | | | | | |

Continued on the following page.

For General GRM Series

Array GNM Series

Low ESL LL□ Series

High-Q GJM Series

High Frequency GOM Series

Monolithic Microchip GMA Series

For Bonding GMD Series

Product Information

GQM Series Specifications and Test Methods

Continued from the preceding page.

| No. | Item | Specifications | Test Method | |
|-----|-----------------------|---|--|--|
| 17 | Humidity Load | The measured and observed characteristics should satisfy the specifications in the following table. | Apply the rated voltage at 40±2°C and 90 to 95% humidity for 500±12 hours. Remove and let sit for 24±2 hours at room temperature then measure. The charge/discharge current is less than 50mA. | |
| | | Appearance | | No defects or abnormalities. |
| | | Capacitance Change | | Within ±7.5% or ±0.75pF (whichever is larger) |
| | | Q | | 30pF and over: $Q \geq 200$ 30pF and below: $Q \geq 100 + 10C/3$ C: Nominal Capacitance (pF) |
| | I.R. | More than 500MΩ | | |
| 18 | High Temperature Load | The measured and observed characteristics should satisfy the specifications in the following table. | Apply 200%* of the rated voltage for 1000±12 hours at the maximum operating temperature ±3°C. Set for 24±2 hours at room temperature, then measure. The charge/discharge current is less than 50mA. *GQM22: 150% of the rated voltage | |
| | | Appearance | | No defects or abnormalities. |
| | | Capacitance Change | | Within ±3% or ±0.3pF (whichever is larger) |
| | | Q | | 30pF and over: $Q \geq 350$ 10pF and over, 30pF and below: $Q \geq 275 + 5C/2$ 10pF and below: $Q \geq 200 + 10C$ C: Nominal Capacitance (pF) |
| | I.R. | More than 1,000MΩ | | |

Table A

| Char. | Nominal Values (ppm/°C) *1 | Capacitance Change from 25°C (%) | | | | | |
|-------|----------------------------|----------------------------------|-------|-------|-------|-------|-------|
| | | -55°C | | -30°C | | -10°C | |
| | | Max. | Min. | Max. | Min. | Max. | Min. |
| 5C | 0±30 | 0.58 | -0.24 | 0.40 | -0.17 | 0.25 | -0.11 |

*1: Nominal values denote the temperature coefficient within a range of 25 to 125°C.

For General GRM Series

Array GNM Series

Low ESL LL□ Series

High-Q GJM Series

High Frequency GOM Series

Monolithic Microchip GMA Series

For Bonding GMD Series

Product Information

GQM Series Data

■ Q - Frequency Characteristics

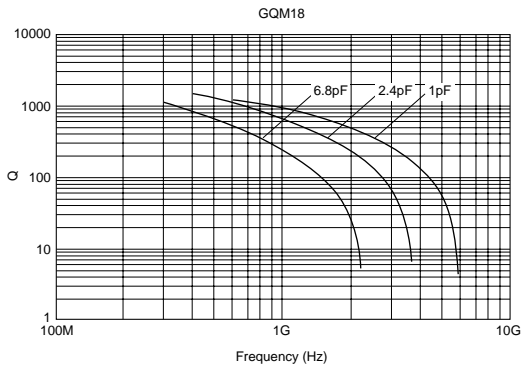

■ Resonant Frequency - Capacitance

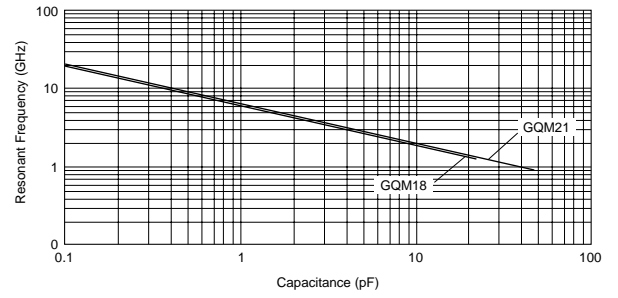

For General
GRM Series

Array
GMM Series

Low ESL
LL□ Series

High-Q
GJM Series

High Frequency
GOM Series

Monolithic Microchip
GMA Series

For Bonding
GMD Series

Product Information

Chip Monolithic Ceramic Capacitors



Monolithic Microchip GMA Series

■ Features

1. Better microwave characteristics
2. Suitable for by passing
3. High density mounting

■ Applications

1. Optical device for telecommunication
2. IC, built-in IC packaging
3. Measuring equipment

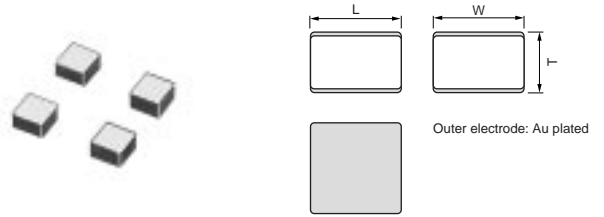

| Part Number | Dimensions (mm) | | |
|---------------|-----------------|------------|------------|
| | L | W | T |
| GMA0D3 | 0.38 ±0.05 | 0.38 ±0.05 | 0.3 ±0.05 |
| GMA05X | 0.5 ±0.05 | 0.5 ±0.05 | 0.35 ±0.05 |
| GMA085 | 0.8 ±0.05 | 0.8 ±0.05 | 0.5 ±0.1 |

For General
GRM Series

Array
GMM Series

Low ESL
LL□ Series

High-Q
GJM Series

High Frequency
GOM Series

Monolithic Microchip
GMA Series

For Bonding
GMD Series

Product Information

Capacitance Table

High Dielectric Constant Type X7R(R7)/X5R(R6) Characteristics

| X | | ex.X: T Dimension [mm] | | | | | | | | | | | | |
|--------------|----------|-------------------------|---------|---------------------|---------|---------|----------|----------|---------------------|---------|----------|--|---|--|
| Capacitance | LxW [mm] | 0.38x0.38 (0D) <015015> | | 0.5x0.5 (05) <0202> | | | | | 0.8x0.8 (08) <0303> | | | | | |
| | | Rated Voltage [Vdc] | 10 (1A) | 100 (2A) | 25 (1E) | 10 (1A) | 6.3 (0J) | 100 (2A) | 25 (1E) | 10 (1A) | 6.3 (0J) | | | |
| 100pF(101) | | | X | | | | | | | | | | | |
| 150pF(151) | | | X | | | | | | | | | | | |
| 220pF(221) | | | X | | | | | | | | | | | |
| 330pF(331) | | | X | | | | | | | | | | | |
| 470pF(471) | | | X | | | | | | | | | | | |
| 680pF(681) | | | X | | | | | | | | | | | |
| 1000pF(102) | | | X | | | | | | | | | | | |
| 1500pF(152) | | | | | X | | | 5 | | | | | | |
| 2200pF(222) | | | | | X | | | 5 | | | | | | |
| 3300pF(332) | | | | | X | | | 5 | | | | | | |
| 4700pF(472) | | | | | X | | | 5 | | | | | | |
| 6800pF(682) | | | | | | X | | 5 | | | | | | |
| 10000pF(103) | 3 | | | | | X | | | 5 | | | | | |
| 15000pF(153) | | | | | | X | | | 5 | | | | | |
| 22000pF(223) | | | | | | X | | | 5 | | | | | |
| 33000pF(333) | | | | | | | | | | 5 | | | | |
| 47000pF(473) | | | | | | | | | | 5 | | | | |
| 68000pF(683) | | | | | | | | | | 5 | | | | |
| 0.10μF(104) | | | | | | | X | | | 5 | | | | |
| 0.47μF(474) | | | | | | | | | | | | | 5 | |

The part number code is shown in () and Unit is shown in []. < >: EIA [inch] Code

For General GRM Series

Array GNM Series

Low ESL LL□ Series

High-Q GJM Series

High Frequency GOM Series

Monolithic Microchip GMA Series

For Bonding GMD Series

Product Information

High Dielectric Constant Type X7R(R7)/X5R(R6) Characteristics

| | | |
|-------------------|-----------|-----------------------|
| LxW [mm] | | 0.38x0.38(0D)<015015> |
| Rated Volt. [Vdc] | | 10(1A) |
| Capacitance | Tolerance | Part Number |
| 10000pF(103) | ±20%(M) | GMA0D3R71A103MA01T |

| LxW [mm] | | 0.5x0.5(05)<0202> | | | |
|-------------------|-----------|--------------------|--------------------|--------------------|---------------------|
| Rated Volt. [Vdc] | | 100(2A) | 25(1E) | 10(1A) | 6.3(0J) |
| Capacitance | Tolerance | Part Number | | | |
| 100pF(101) | ±20%(M) | GMA05XR72A101MA01T | | | |
| 150pF(151) | ±20%(M) | GMA05XR72A151MA01T | | | |
| 220pF(221) | ±20%(M) | GMA05XR72A221MA01T | | | |
| 330pF(331) | ±20%(M) | GMA05XR72A331MA01T | | | |
| 470pF(471) | ±20%(M) | GMA05XR72A471MA01T | | | |
| 680pF(681) | ±20%(M) | GMA05XR72A681MA01T | | | |
| 1000pF(102) | ±20%(M) | GMA05XR72A102MA01T | | | |
| 1500pF(152) | ±20%(M) | | GMA05XR71E152MA11T | | |
| 2200pF(222) | ±20%(M) | | GMA05XR71E222MA11T | | |
| 3300pF(332) | ±20%(M) | | GMA05XR71E332MA11T | | |
| 4700pF(472) | ±20%(M) | | GMA05XR71E472MA11T | | |
| 6800pF(682) | ±20%(M) | | | GMA05XR71A682MA01T | |
| 10000pF(103) | ±20%(M) | | | GMA05XR71A103MA01T | |
| 15000pF(153) | ±20%(M) | | | GMA05XR71A153MA01T | |
| 22000pF(223) | ±20%(M) | | | GMA05XR71A223MA01T | |
| 33000pF(333) | ±20%(M) | | | | |
| 47000pF(473) | ±20%(M) | | | | |
| 68000pF(683) | ±20%(M) | | | | |
| 0.10μF(104) | ±20%(M) | | | | GMA05XR60J104ME12T* |

| LxW [mm] | | 0.8x0.8(08)<0303> | | | |
|-------------------|-----------|--------------------|--------------------|--------------------|---------------------|
| Rated Volt. [Vdc] | | 100(2A) | 25(1E) | 10(1A) | 6.3(0J) |
| Capacitance | Tolerance | Part Number | | | |
| 1500pF(152) | ±20%(M) | GMA085R72A152MA01T | | | |
| 2200pF(222) | ±20%(M) | GMA085R72A222MA01T | | | |
| 3300pF(332) | ±20%(M) | GMA085R72A332MA01T | | | |
| 4700pF(472) | ±20%(M) | GMA085R72A472MA01T | | | |
| 6800pF(682) | ±20%(M) | GMA085R72A682MA01T | | | |
| 10000pF(103) | ±20%(M) | | GMA085R71E103MA11T | | |
| 15000pF(153) | ±20%(M) | | GMA085R71E153MA11T | | |
| 22000pF(223) | ±20%(M) | | GMA085R71E223MA11T | | |
| 33000pF(333) | ±20%(M) | | | GMA085R71A333MA01T | |
| 47000pF(473) | ±20%(M) | | | GMA085R71A473MA01T | |
| 68000pF(683) | ±20%(M) | | | GMA085R71A683MA01T | |
| 0.10μF(104) | ±20%(M) | | | GMA085R71A104MA01T | |
| 0.47μF(474) | ±20%(M) | | | | GMA085R60J474ME12T* |

The part number code is shown in () and Unit is shown in []. < >: EIA [inch] Code
 * Please refer to GMA series Specifications and Test Method (2).

(Part Number) **GM** **A** **0D** **3** **R7** **1A** **103** **M** **A01** **T** ①Product ID ②Series ③Dimensions (LxW) ④Dimension (T)
 ⑤Temperature Characteristics ⑥Rated Voltage ⑦Capacitance
 ⑧Capacitance Tolerance ⑨Individual Specification Code ⑩Packaging

Packaging Code in Part Number shows STD Tray.

GMA Series Specifications and Test Methods (1)

When no "*" is added in PNs table, please refer to GMA Series Specifications and Test Methods (1).
 When "*" is added in PNs table, please refer to GMA Series Specifications and Test Methods (2).

| No. | Item | Specifications | Test Method | | | | | | | | | | | | | | | |
|-------------|---|---|---|------------|------------------|---------|-----------|---|------------|----------------------------|------------|----------------------------|------------|-------------|------|--------|------|--------|
| 1 | Operating Temperature Range | R7: -55 to +125°C | Reference Temperature: 25°C | | | | | | | | | | | | | | | |
| 2 | Rated Voltage | See the previous pages. | The rated voltage is defined as the maximum voltage that may be applied continuously to the capacitor. When AC voltage is superimposed on DC voltage, V ^{P-P} or V ^{O-P} , whichever is larger, should be maintained within the rated voltage range. | | | | | | | | | | | | | | | |
| 3 | Appearance | No defects or abnormalities | Visual inspection | | | | | | | | | | | | | | | |
| 4 | Dimensions | Within the specified dimensions | Using calipers | | | | | | | | | | | | | | | |
| 5 | Dielectric Strength | No defects or abnormalities | No failure should be observed when a voltage of 250% of the rated voltage is applied between the both terminations for 1 to 5 seconds, provided the charge/discharge current is less than 50mA. | | | | | | | | | | | | | | | |
| 6 | Insulation Resistance | More than 10,000MΩ or 500ΩF (whichever is smaller) | The insulation resistance should be measured with a DC voltage not exceeding the rated voltage at normal temperature and humidity and within 2 minutes of charging. | | | | | | | | | | | | | | | |
| 7 | Capacitance | Within the specified tolerance | The capacitance/D.F. should be measured at reference temperature at the frequency and voltage shown in the table. | | | | | | | | | | | | | | | |
| 8 | Dissipation Factor (D.F.) | R7: W.V.: 25V min.; 0.025 max. W.V.: 16V/10V; 0.035 max. | <table border="1" style="margin-left: auto; margin-right: auto;"> <tr> <td>Frequency</td> <td>1±0.1kHz</td> </tr> <tr> <td>Voltage</td> <td>1±0.2Vrms</td> </tr> </table> | Frequency | 1±0.1kHz | Voltage | 1±0.2Vrms | | | | | | | | | | | |
| Frequency | 1±0.1kHz | | | | | | | | | | | | | | | | | |
| Voltage | 1±0.2Vrms | | | | | | | | | | | | | | | | | |
| 9 | Capacitance Temperature Characteristics | No bias R7: Within +/-15% (-55 to +125°C) | The capacitance change should be measured after 5 min. at each specified temp. stage. •The ranges of capacitance change compared with the Reference Temperature value over the temperature ranges shown in the table should be within the specified ranges.* <table border="1" style="margin-left: auto; margin-right: auto;"> <thead> <tr> <th>Step</th> <th>Temperature (°C)</th> </tr> </thead> <tbody> <tr> <td>1</td> <td>25±2</td> </tr> <tr> <td>2</td> <td>-55±3</td> </tr> <tr> <td>3</td> <td>25±2</td> </tr> <tr> <td>4</td> <td>125±3</td> </tr> </tbody> </table> *Initial measurement for high dielectric constant type Perform a heat treatment at 150 +0/-10°C for one hour and then let sit for 24±2 hours at room temperature. Perform the initial measurement. | Step | Temperature (°C) | 1 | 25±2 | 2 | -55±3 | 3 | 25±2 | 4 | 125±3 | | | | | |
| Step | Temperature (°C) | | | | | | | | | | | | | | | | | |
| 1 | 25±2 | | | | | | | | | | | | | | | | | |
| 2 | -55±3 | | | | | | | | | | | | | | | | | |
| 3 | 25±2 | | | | | | | | | | | | | | | | | |
| 4 | 125±3 | | | | | | | | | | | | | | | | | |
| 10 | Mechanical Strength | Bond Strength | Pull force: 0.03N min. MIL-STD-883 Method 2011 Condition D Mount the capacitor on a gold metallized alumina substrate with Au-Sn (80/20) and bond a 25μm (0.001 inch) gold wire to the capacitor terminal using an ultrasonic ball bond. Then, pull wire. | | | | | | | | | | | | | | | |
| | | Die Shear Strength | Die Shear force: 2N min. MIL-STD-883 Method 2019 Mount the capacitor on a gold metallized alumina substrate with Au-Sn (80/20). Apply the force parallel to the substrate. | | | | | | | | | | | | | | | |
| 11 | Vibration Resistance | Appearance | No defects or abnormalities | | | | | | | | | | | | | | | |
| | | Capacitance | Within the specified tolerance | | | | | | | | | | | | | | | |
| | | D.F. | R7: W.V.: 25V min.; 0.025 max. W.V.: 16V/10V; 0.035 max. Ramp frequency from 10 to 55Hz then return to 10Hz all within 1 minute. Amplitude: 1.5 mm (0.06 inch) max. total excursion. Apply this motion for a period of 2 hours in each of 3 mutually perpendicular directions (total 6 hours). | | | | | | | | | | | | | | | |
| 12 | Temperature Cycle | Appearance | No defects or abnormalities | | | | | | | | | | | | | | | |
| | | Capacitance Change | R7: Within ±7.5% | | | | | | | | | | | | | | | |
| | | D.F. | R7: W.V.: 25V min.; 0.025 max. W.V.: 16V/10V; 0.035 max. | | | | | | | | | | | | | | | |
| | | I.R. | More than 10,000MΩ or 500ΩF (whichever is smaller) | | | | | | | | | | | | | | | |
| | | Dielectric Strength | No defects | | | | | | | | | | | | | | | |
| | | | The capacitor should be set for 24±2 hours at room temperature after one hour of heat treatment at 150+0/-10°C, then measure for the initial measurement. Fix the capacitor to the supporting jig in the same manner and under the same conditions as (11) and conduct the five cycles according to the temperatures and time shown in the following table. Set it for 24±2 hours at room temperature, then measure. | | | | | | | | | | | | | | | |
| | | | <table border="1" style="margin-left: auto; margin-right: auto;"> <thead> <tr> <th>Step</th> <th>1</th> <th>2</th> <th>3</th> <th>4</th> </tr> </thead> <tbody> <tr> <td>Temp. (°C)</td> <td>Min. Operating Temp. +0/-3</td> <td>Room Temp.</td> <td>Max. Operating Temp. +3/-0</td> <td>Room Temp.</td> </tr> <tr> <td>Time (min.)</td> <td>30±3</td> <td>2 to 3</td> <td>30±3</td> <td>2 to 3</td> </tr> </tbody> </table> | Step | 1 | 2 | 3 | 4 | Temp. (°C) | Min. Operating Temp. +0/-3 | Room Temp. | Max. Operating Temp. +3/-0 | Room Temp. | Time (min.) | 30±3 | 2 to 3 | 30±3 | 2 to 3 |
| Step | 1 | 2 | 3 | 4 | | | | | | | | | | | | | | |
| Temp. (°C) | Min. Operating Temp. +0/-3 | Room Temp. | Max. Operating Temp. +3/-0 | Room Temp. | | | | | | | | | | | | | | |
| Time (min.) | 30±3 | 2 to 3 | 30±3 | 2 to 3 | | | | | | | | | | | | | | |

Mounting for testing: The capacitors should be mounted on the substrate as shown below using die bonding and wire bonding when tests No. 11 to 15 are performed.

Continued on the following page.

For General GRM Series

Array GNM Series

Low ESL LL□ Series

High-Q GJM Series

High Frequency GOM Series

Monolithic Microchip GMA Series

For Bonding GMD Series

Product Information

GMA Series Specifications and Test Methods (1)

Continued from the preceding page.

When no "*" is added in PNs table, please refer to GMA Series Specifications and Test Methods (1).
 When "*" is added in PNs table, please refer to GMA Series Specifications and Test Methods (2).

| No. | Item | Specifications | Test Method |
|-----|----------------------------|--------------------|--|
| 13 | Humidity (Steady State) | Appearance | No defects or abnormalities |
| | | Capacitance Change | R7: Within $\pm 12.5\%$ |
| | | D.F. | R7: W.V.: 10V min.; 0.05 max. |
| | | I.R. | More than 1,000M Ω or 50 Ω F (whichever is smaller) |
| 14 | Humidity Load | Appearance | No defects or abnormalities |
| | | Capacitance Change | R7: Within $\pm 12.5\%$ |
| | | D.F. | R7: W.V.: 10V min.; 0.05 max. |
| | | I.R. | More than 500M Ω or 25 Ω F (whichever is smaller) |
| 15 | High Temperature Load | Appearance | No defects or abnormalities |
| | | Capacitance Change | R7: Within $\pm 12.5\%$ |
| | | D.F. | R7: W.V.: 10V min.; 0.05 max. |
| | | I.R. | More than 1,000M Ω or 50 Ω F (whichever is smaller) |
| | | | Set the capacitor for 500 \pm 12 hours at 40 \pm 2 $^{\circ}$ C, in 90 to 95% humidity. Take it out and set it for 24 \pm 2 hours at room temperature, then measure. |
| | | | Apply the rated voltage for 500 \pm 12 hours at 40 \pm 2 $^{\circ}$ C, in 90 to 95% humidity and set it for 24 \pm 2 hours at room temperature, then measure. The charge/discharge current is less than 50mA. |
| | | | A voltage treatment should be given to the capacitor, in which a DC voltage of 200% the rated voltage is applied for one hour at the maximum operating temperature; $\pm 3^{\circ}$ C then it should be set for 24 \pm 2 hours at room temperature and the initial measurement should be conducted. Then apply the above mentioned voltage continuously for 1000 \pm 12 hours at the same temperature, remove it from the bath, and set it for 24 \pm 2 hours at room temperature, then measure. The charge/discharge current is less than 50mA. |

Mounting for testing: The capacitors should be mounted on the substrate as shown below using die bonding and wire bonding when tests No. 11 to 15 are performed.

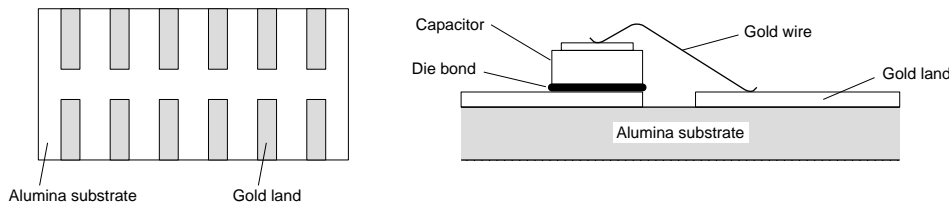

For General
GRM Series

Array
GMM Series

Low ESL
LL□ Series

High-Q
GJM Series

High Frequency
GQM Series

Monolithic Microchip
GMA Series

For Bonding
GMD Series

Product Information

GMA Series Specifications and Test Methods (2)

When no "*" is added in PNs table, please refer to GMA Series Specifications and Test Methods (1).
 When "*" is added in PNs table, please refer to GMA Series Specifications and Test Methods (2).

| No. | Item | Specifications | Test Method | | | | | | | | | | | | | | | | | |
|---------------------|---|--|--|-------------|------------------|---------|---------------------|------------|---------------|---|------------|----------------------------|------------|----------------------------|------------|-------------|--------|--------|--------|--------|
| 1 | Operating Temperature Range | R6 : -55°C to 85°C | Reference Temperature : 25°C | | | | | | | | | | | | | | | | | |
| 2 | Rated Voltage | See the previous pages. | The rated voltage is defined as the maximum voltage that may be applied continuously to the capacitor. When AC voltage is superimposed on DC voltage, V ^{P-P} or V ^{O-P} , whichever is larger, should be maintained within the rated voltage range. | | | | | | | | | | | | | | | | | |
| 3 | Appearance | No defects or abnormalities. | Visual inspection. | | | | | | | | | | | | | | | | | |
| 4 | Dimensions | Within the specified dimensions. | Using calipers. | | | | | | | | | | | | | | | | | |
| 5 | Dielectric Strength | No defects or abnormalities. | No failure should be observed when 250% of the rated voltage is applied between the terminations for 1 to 5 seconds, provided the charge/discharge current is less than 50mA. | | | | | | | | | | | | | | | | | |
| 6 | Insulation Resistance | More than 50Ω · F | The insulation resistance should be measured with a DC voltage not exceeding the rated voltage at normal temperature and humidity and within 1 minutes of charging. | | | | | | | | | | | | | | | | | |
| 7 | Capacitance | Within the specified tolerance. | The capacitance/D.F. should be measured at reference temperature at the frequency and voltage shown in the table. | | | | | | | | | | | | | | | | | |
| 8 | Dissipation Factor (D.F.) | R6 : 0.1 max. | <table border="1" style="margin-left: auto; margin-right: auto;"> <thead> <tr> <th>Capacitance</th> <th>Frequency</th> <th>Voltage</th> </tr> </thead> <tbody> <tr> <td>C ≤ 10μF (6.3Vmax.)</td> <td>1 ± 0.1kHz</td> <td>0.5 ± 0.1Vrms</td> </tr> </tbody> </table> | Capacitance | Frequency | Voltage | C ≤ 10μF (6.3Vmax.) | 1 ± 0.1kHz | 0.5 ± 0.1Vrms | | | | | | | | | | | |
| Capacitance | Frequency | Voltage | | | | | | | | | | | | | | | | | | |
| C ≤ 10μF (6.3Vmax.) | 1 ± 0.1kHz | 0.5 ± 0.1Vrms | | | | | | | | | | | | | | | | | | |
| 9 | Capacitance Temperature Characteristics | No bias R6 : Within ±15% (-55°C to +85°C) | <p>The capacitance change should be measured after 5 min. at each specified temp. stage.</p> <p>The ranges of capacitance change compared with the Reference Temperature value over the temperature ranges shown in the table should be within the specified ranges.*</p> <table border="1" style="margin-left: auto; margin-right: auto;"> <thead> <tr> <th>Step</th> <th>Temperature (°C)</th> </tr> </thead> <tbody> <tr> <td>1</td> <td>25 ± 2</td> </tr> <tr> <td>2</td> <td>-55 ± 3</td> </tr> <tr> <td>3</td> <td>25 ± 2</td> </tr> <tr> <td>4</td> <td>85 ± 3</td> </tr> </tbody> </table> <p>*Initial measurement for high dielectric constant type Perform a heat treatment at 150 +0/-10°C for one hour and then let sit for 24 ± 2 hours at room temperature. Perform the initial measurement.</p> | Step | Temperature (°C) | 1 | 25 ± 2 | 2 | -55 ± 3 | 3 | 25 ± 2 | 4 | 85 ± 3 | | | | | | | |
| Step | Temperature (°C) | | | | | | | | | | | | | | | | | | | |
| 1 | 25 ± 2 | | | | | | | | | | | | | | | | | | | |
| 2 | -55 ± 3 | | | | | | | | | | | | | | | | | | | |
| 3 | 25 ± 2 | | | | | | | | | | | | | | | | | | | |
| 4 | 85 ± 3 | | | | | | | | | | | | | | | | | | | |
| 10 | Mechanical Strength | Bond Strength | Pull force : 0.03N min. MIL-STD-883 Method 2011 Condition D Mount the capacitor on a gold metallized alumina substrate with Au-Sn (80/20) and bond a 25μm (0.001 inch) gold wire to the capacitor terminal using an ultrasonic ball bond. Then, pull wire. | | | | | | | | | | | | | | | | | |
| | | Die Shear Strength | Die Shear force : 2N min. MIL-STD-883 Method 2019 Mount the capacitor on a gold metallized alumina substrate with Au-Sn (80/20). Apply the force parallel to the substrate. | | | | | | | | | | | | | | | | | |
| 11 | Vibration Resistance | Appearance | No defects or abnormalities. | | | | | | | | | | | | | | | | | |
| | | Capacitance | Within the specified tolerance. | | | | | | | | | | | | | | | | | |
| | | D.F. | R6 : 0.1 max. Ramp frequency from 10 to 55Hz then return to 10Hz all within 1 minute. Amplitude: 1.5 mm (0.06 inch) max. total excursion. Apply this motion for a period of 2 hours in each of 3 mutually perpendicular directions (total 6 hours). | | | | | | | | | | | | | | | | | |
| 12 | Temperature Sudden Change | Appearance | No defects or abnormalities. | | | | | | | | | | | | | | | | | |
| | | Capacitance Change | R6 : Within ±7.5% | | | | | | | | | | | | | | | | | |
| | | D.F. | R6 : 0.1 max. | | | | | | | | | | | | | | | | | |
| | | I.R. | More than 50Ω · F | | | | | | | | | | | | | | | | | |
| | | Dielectric Strength | No defects The capacitor should be set for 24 ± 2 hours at room temperature after one hour of heat treatment at 150 +0/-10°C, then measure for the initial measurement. Fix the capacitor to the supporting jig in the same manner and under the same conditions as (11) and conduct the five cycles according to the temperatures and time shown in the following table. Set it for 48 ± 4 hours at room temperature, then measure. | | | | | | | | | | | | | | | | | |
| | | <table border="1" style="margin-left: auto; margin-right: auto;"> <thead> <tr> <th>Step</th> <th>1</th> <th>2</th> <th>3</th> <th>4</th> </tr> </thead> <tbody> <tr> <td>Temp. (°C)</td> <td>Min. Operating Temp. +0/-3</td> <td>Room Temp.</td> <td>Max. Operating Temp. +3/-0</td> <td>Room Temp.</td> </tr> <tr> <td>Time (min.)</td> <td>30 ± 3</td> <td>2 to 3</td> <td>30 ± 3</td> <td>2 to 3</td> </tr> </tbody> </table> | | | | Step | 1 | 2 | 3 | 4 | Temp. (°C) | Min. Operating Temp. +0/-3 | Room Temp. | Max. Operating Temp. +3/-0 | Room Temp. | Time (min.) | 30 ± 3 | 2 to 3 | 30 ± 3 | 2 to 3 |
| Step | 1 | 2 | 3 | 4 | | | | | | | | | | | | | | | | |
| Temp. (°C) | Min. Operating Temp. +0/-3 | Room Temp. | Max. Operating Temp. +3/-0 | Room Temp. | | | | | | | | | | | | | | | | |
| Time (min.) | 30 ± 3 | 2 to 3 | 30 ± 3 | 2 to 3 | | | | | | | | | | | | | | | | |

Mounting for testing: The capacitors should be mounted on the substrate as shown below using die bonding and wire bonding when tests No. 11 to 14 are performed.

Continued on the following page.

For General GRM Series

Array GNM Series

Low ESL LL□ Series

High-Q GJM Series

High Frequency GOM Series

Monolithic Microchip GMA Series

For Bonding GMD Series

Product Information

GMA Series Specifications and Test Methods (2)

Continued from the preceding page.

When no "***" is added in PNs table, please refer to GMA Series Specifications and Test Methods (1).
 When "***" is added in PNs table, please refer to GMA Series Specifications and Test Methods (2).

| No. | Item | Specifications | Test Method |
|-----|--|------------------------------|--|
| 13 | Appearance | No defects or abnormalities. | Apply the rated voltage for 500±12 hours at 40±2°C, in 90 to 95% humidity and set it for 24±2 hours at room temperature, then measure. The charge/discharge current is less than 50mA. • Initial measurement Perform a heat treatment at 150+0/-10°C for one hour and then let sit for 24±2 hours at room temperature. Perform the initial measurement. • Measurement after test Perform a heat treatment at 150+0/-10°C for one hour and then let sit for 24±2 hours at room temperature, then measure. |
| | Capacitance Change | R6 : Within ±12.5% | |
| | D.F. | R6 : 0.2 max. | |
| | High Temperature High Humidity (Steady) I.R. | More than 12.5Ω · F | |
| 14 | Appearance | No defects or abnormalities. | Apply 150% of the rated voltage for 1000±12 hours at the maximum operating temperature ±3°C. Let sit for 24±2 hours at room temperature, then measure. The charge/ discharge current is less than 50mA. • Initial measurement Perform a heat treatment at 150+0/-10°C for one hour and then let sit for 24±2 hours at room temperature. Perform the initial measurement. • Measurement after test Perform a heat treatment at 150+0/-10°C for one hour and then let sit for 24±2 hours at room temperature, then measure. |
| | Capacitance Change | R6 : Within ±12.5% | |
| | D.F. | R6 : 0.2 max. | |
| | Durability I.R. | More than 25Ω · F | |

Mounting for testing: The capacitors should be mounted on the substrate as shown below using die bonding and wire bonding when tests No. 11 to 14 are performed.

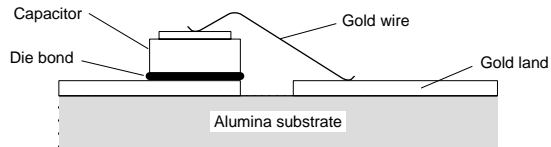
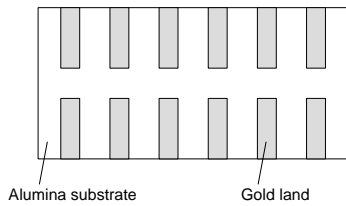

For General
GRM Series

Array
GMM Series

Low ESL
LL□ Series

High-Q
GJM Series

High Frequency
GQM Series

Monolithic Microchip
GMA Series

For Bonding
GMD Series

Product Information

Chip Monolithic Ceramic Capacitors



for Bonding GMD Series

■ Features

1. Small chip size (LxWxT: 0.6x0.3x0.3, 1.0x0.5x0.5mm)
2. Available for Wire/Die bonding due to Gold termination.
3. Suitable for Optical device for telecommunication, built-in IC packaging.

■ Applications

1. Optical device for telecommunication
2. IC, built-in IC packaging

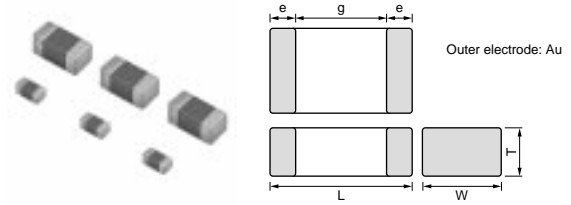

| Part Number | Dimensions (mm) | | | | |
|---------------|-----------------|----------|----------|--------------|--------|
| | L | W | T | e | g min. |
| GMD033 | 0.6±0.03 | 0.3±0.03 | 0.3±0.03 | 0.12 to 0.22 | 0.16 |
| GMD155 | 1.0±0.05 | 0.5±0.05 | 0.5±0.05 | 0.15 to 0.35 | 0.3 |

For General
GRM Series

Array
GMM Series

Low ESL
LL□ Series

High-Q
GJM Series

High Frequency
GOM Series

Monolithic Microchip
GMA Series

For Bonding
GMD Series

Product Information

Capacitance Table

High Dielectric Constant Type X7R(R7)/X5R(R6) Characteristics

| | | 3 ex.3: T Dimension [mm] | | | | | | | |
|--------------|---------------------|--------------------------|---------|---------|---------------------|---------|---------|---------------------|---------------------|
| Capacitance | LxW [mm] | 0.6x0.3 (03) <0201> | | | 1.0x0.5 (15) <0402> | | | 0.6x0.3 (03) <0201> | 1.0x0.5 (15) <0402> |
| | Rated Voltage [Vdc] | 25 (1E) | 16 (1C) | 10 (1A) | 50 (1H) | 25 (1E) | 16 (1C) | 6.3 (0J) | 10 (1A) |
| 100pF(101) | 3 | | | | | | | | |
| 120pF(121) | 3 | | | | | | | | |
| 150pF(151) | 3 | | | | | | | | |
| 180pF(181) | 3 | | | | | | | | |
| 220pF(221) | 3 | | | | 5 | | | | |
| 270pF(271) | 3 | | | | 5 | | | | |
| 330pF(331) | 3 | | | | 5 | | | | |
| 390pF(391) | 3 | | | | 5 | | | | |
| 470pF(471) | 3 | | | | 5 | | | | |
| 560pF(561) | 3 | | | | 5 | | | | |
| 680pF(681) | 3 | | | | 5 | | | | |
| 820pF(821) | 3 | | | | 5 | | | | |
| 1000pF(102) | 3 | | | | 5 | | | | |
| 1200pF(122) | 3 | | | | 5 | | | | |
| 1500pF(152) | 3 | | | | 5 | | | | |
| 1800pF(182) | | 3 | | | 5 | | | | |
| 2200pF(222) | | 3 | | | 5 | | | | |
| 2700pF(272) | | 3 | | | 5 | | | | |
| 3300pF(332) | | 3 | | | 5 | | | | |
| 3900pF(392) | | | 3 | | 5 | | | | |
| 4700pF(472) | | | 3 | | 5 | | | | |
| 5600pF(562) | | | 3 | | | 5 | | | |
| 6800pF(682) | | | 3 | | | 5 | | | |
| 8200pF(822) | | | 3 | | | 5 | | | |
| 10000pF(103) | | | 3 | | | 5 | | | |
| 12000pF(123) | | | | | | 5 | | | |
| 15000pF(153) | | | | | | 5 | | | |
| 18000pF(183) | | | | | | 5 | | | |
| 22000pF(223) | | | | | | 5 | | | |
| 27000pF(273) | | | | | | 5 | | | |
| 33000pF(333) | | | | | | 5 | | | |
| 39000pF(393) | | | | | | 5 | | | |
| 47000pF(473) | | | | | | 5 | | | |
| 56000pF(563) | | | | | | | 5 | 3 | |
| 68000pF(683) | | | | | | | 5 | 3 | |
| 82000pF(823) | | | | | | | 5 | 3 | |
| 0.10μF(104) | | | | | | | 5 | 3 | |
| 0.12μF(124) | | | | | | | | | 5 |
| 0.15μF(154) | | | | | | | | | 5 |
| 0.18μF(184) | | | | | | | | | 5 |
| 0.22μF(224) | | | | | | | | | 5 |
| 0.27μF(274) | | | | | | | | | 5 |
| 0.33μF(334) | | | | | | | | | 5 |
| 0.39μF(394) | | | | | | | | | 5 |
| 0.47μF(474) | | | | | | | | | 5 |

The part number code is shown in () and Unit is shown in []. < >: EIA [inch] Code

High Dielectric Constant Type X7R(R7) Characteristics

| LxW [mm] | | 0.6x0.3(03)<0201> | | |
|-------------------|-----------|--------------------|--------------------|--------------------|
| Rated Volt. [Vdc] | | 25(1E) | 16(1C) | 10(1A) |
| Capacitance | Tolerance | Part Number | | |
| 100pF(101) | ±10%(K) | GMD033R71E101KA01D | | |
| 120pF(121) | ±10%(K) | GMD033R71E121KA01D | | |
| 150pF(151) | ±10%(K) | GMD033R71E151KA01D | | |
| 180pF(181) | ±10%(K) | GMD033R71E181KA01D | | |
| 220pF(221) | ±10%(K) | GMD033R71E221KA01D | | |
| 270pF(271) | ±10%(K) | GMD033R71E271KA01D | | |
| 330pF(331) | ±10%(K) | GMD033R71E331KA01D | | |
| 390pF(391) | ±10%(K) | GMD033R71E391KA01D | | |
| 470pF(471) | ±10%(K) | GMD033R71E471KA01D | | |
| 560pF(561) | ±10%(K) | GMD033R71E561KA01D | | |
| 680pF(681) | ±10%(K) | GMD033R71E681KA01D | | |
| 820pF(821) | ±10%(K) | GMD033R71E821KA01D | | |
| 1000pF(102) | ±10%(K) | GMD033R71E102KA01D | | |
| 1200pF(122) | ±10%(K) | GMD033R71E122KA01D | | |
| 1500pF(152) | ±10%(K) | GMD033R71E152KA01D | | |
| 1800pF(182) | ±10%(K) | | GMD033R71C182KA11D | |
| 2200pF(222) | ±10%(K) | | GMD033R71C222KA11D | |
| 2700pF(272) | ±10%(K) | | GMD033R71C272KA11D | |
| 3300pF(332) | ±10%(K) | | GMD033R71C332KA11D | |
| 3900pF(392) | ±10%(K) | | | GMD033R71A392KA01D |
| 4700pF(472) | ±10%(K) | | | GMD033R71A472KA01D |
| 5600pF(562) | ±10%(K) | | | GMD033R71A562KA01D |
| 6800pF(682) | ±10%(K) | | | GMD033R71A682KA01D |
| 8200pF(822) | ±10%(K) | | | GMD033R71A822KA01D |
| 10000pF(103) | ±10%(K) | | | GMD033R71A103KA01D |

The part number code is shown in () and Unit is shown in []. < >: EIA [inch] Code

(Part Number) **GM D 03 3 R7 1E 101 K A01 D** ①Product ID ②Series ③Dimensions (LxW) ④Dimension (T)
 ⑤Temperature Characteristics ⑥Rated Voltage ⑦Capacitance
 ⑧Capacitance Tolerance ⑨Individual Specification Code ⑩Packaging

Packaging Code in Part Number shows STD 180mm Reel Taping.

For General GRM Series
 Array GNM Series
 Low ESL LL□ Series
 High-Q GJM Series
 High Frequency GQM Series
 Monolithic Microchip GMA Series
 For Bonding GMD Series
 Product Information

High Dielectric Constant Type X7R(R7) Characteristics

| LxW [mm] | | 1.0x0.5(15)<0402> | | |
|-------------------|-----------|--------------------|--------------------|--------------------|
| Rated Volt. [Vdc] | | 50(1H) | 25(1E) | 16(1C) |
| Capacitance | Tolerance | Part Number | | |
| 220pF(221) | ±10%(K) | GMD155R71H221KA01D | | |
| 270pF(271) | ±10%(K) | GMD155R71H271KA01D | | |
| 330pF(331) | ±10%(K) | GMD155R71H331KA01D | | |
| 390pF(391) | ±10%(K) | GMD155R71H391KA01D | | |
| 470pF(471) | ±10%(K) | GMD155R71H471KA01D | | |
| 560pF(561) | ±10%(K) | GMD155R71H561KA01D | | |
| 680pF(681) | ±10%(K) | GMD155R71H681KA01D | | |
| 820pF(821) | ±10%(K) | GMD155R71H821KA01D | | |
| 1000pF(102) | ±10%(K) | GMD155R71H102KA01D | | |
| 1200pF(122) | ±10%(K) | GMD155R71H122KA01D | | |
| 1500pF(152) | ±10%(K) | GMD155R71H152KA01D | | |
| 1800pF(182) | ±10%(K) | GMD155R71H182KA01D | | |
| 2200pF(222) | ±10%(K) | GMD155R71H222KA01D | | |
| 2700pF(272) | ±10%(K) | GMD155R71H272KA01D | | |
| 3300pF(332) | ±10%(K) | GMD155R71H332KA01D | | |
| 3900pF(392) | ±10%(K) | GMD155R71H392KA01D | | |
| 4700pF(472) | ±10%(K) | GMD155R71H472KA01D | | |
| 5600pF(562) | ±10%(K) | | GMD155R71E562KA01D | |
| 6800pF(682) | ±10%(K) | | GMD155R71E682KA01D | |
| 8200pF(822) | ±10%(K) | | GMD155R71E822KA01D | |
| 10000pF(103) | ±10%(K) | | GMD155R71E103KA01D | |
| 12000pF(123) | ±10%(K) | | GMD155R71E123KA01D | |
| 15000pF(153) | ±10%(K) | | GMD155R71E153KA01D | |
| 18000pF(183) | ±10%(K) | | GMD155R71E183KA01D | |
| 22000pF(223) | ±10%(K) | | GMD155R71E223KA01D | |
| 27000pF(273) | ±10%(K) | | GMD155R71E273KA11D | |
| 33000pF(333) | ±10%(K) | | GMD155R71E333KA11D | |
| 39000pF(393) | ±10%(K) | | GMD155R71E393KA11D | |
| 47000pF(473) | ±10%(K) | | GMD155R71E473KA11D | |
| 56000pF(563) | ±10%(K) | | | GMD155R71C563KA11D |
| 68000pF(683) | ±10%(K) | | | GMD155R71C683KA11D |
| 82000pF(823) | ±10%(K) | | | GMD155R71C823KA11D |
| 0.10μF(104) | ±10%(K) | | | GMD155R71C104KA11D |

The part number code is shown in () and Unit is shown in []. < >: EIA [inch] Code

(Part Number) **GM** **D** **15** **5** **R7** **1H** **221** **K** **A01** **D** ①Product ID ②Series ③Dimensions (LxW) ④Dimension (T)
 ⑤Temperature Characteristics ⑥Rated Voltage ⑦Capacitance
 ⑧Capacitance Tolerance ⑨Individual Specification Code ⑩Packaging

Packaging Code in Part Number shows STD 180mm Reel Taping.

High Dielectric Constant Type X5R(R6) Characteristics

| LxW [mm] | | 0.6x0.3(03)<0201> | 1.0x0.5(15)<0402> |
|-------------------|-----------|---------------------|---------------------|
| Rated Volt. [Vdc] | | 6.3(0J) | 10(1A) |
| Capacitance | Tolerance | Part Number | |
| 56000pF(563) | ±10%(K) | GMD033R60J563KE11D* | |
| 68000pF(683) | ±10%(K) | GMD033R60J683KE11D* | |
| 82000pF(823) | ±10%(K) | GMD033R60J823KE11D* | |
| 0.10μF(104) | ±10%(K) | GMD033R60J104KE11D* | |
| 0.12μF(124) | ±10%(K) | | GMD155R61A124KE12D* |
| 0.15μF(154) | ±10%(K) | | GMD155R61A154KE12D* |
| 0.18μF(184) | ±10%(K) | | GMD155R61A184KE12D* |
| 0.22μF(224) | ±10%(K) | | GMD155R61A224KE12D* |
| 0.27μF(274) | ±10%(K) | | GMD155R61A274KE11D* |
| 0.33μF(334) | ±10%(K) | | GMD155R61A334KE11D* |
| 0.39μF(394) | ±10%(K) | | GMD155R61A394KE11D* |
| 0.47μF(474) | ±10%(K) | | GMD155R61A474KE11D* |

The part number code is shown in () and Unit is shown in []. < >: EIA [inch] Code

* Please refer to GMD series Specifications and Test Method (2).

For General GRM Series

Array GNM Series

Low ESL LL□ Series

High-Q GJM Series

High Frequency GOM Series

Monolithic Microchip GMA Series

For Bonding GMD Series

Product Information

GMD Series Specifications and Test Methods (1)

When no "***" is added in PNs table, please refer to GMD Series Specifications and Test Methods (1).
 When "***" is added in PNs table, please refer to GMD Series Specifications and Test Methods (2).

| No. | Item | Specifications | Test Method | | | | | | | | | | | | | | | |
|-------------|---|---|--|------------|------------------|---------|-----------|---|------------|----------------------------|------------|----------------------------|------------|-------------|--------|--------|--------|--------|
| 1 | Operating Temperature Range | R7 : -55°C to 125°C | Reference Temperature : 25°C | | | | | | | | | | | | | | | |
| 2 | Rated Voltage | See the previous pages. | The rated voltage is defined as the maximum voltage that may be applied continuously to the capacitor. When AC voltage is superimposed on DC voltage, V ^{P-P} or V ^{O-P} , whichever is larger, should be maintained within the rated voltage range. | | | | | | | | | | | | | | | |
| 3 | Appearance | No defects or abnormalities. | Visual inspection. | | | | | | | | | | | | | | | |
| 4 | Dimensions | Within the specified dimensions. | Using calipers. | | | | | | | | | | | | | | | |
| 5 | Dielectric Strength | No defects or abnormality. | No failure should be observed when 250% of the rated voltage is applied between the terminations for 1 to 5 seconds, provided the charge/discharge current is less than 50mA. | | | | | | | | | | | | | | | |
| 6 | Insulation Resistance | More than 10,000MΩ or 500Ω · F (whichever is smaller) | The insulation resistance should be measured with a DC voltage not exceeding the rated voltage at normal temperature and humidity and within 2 minutes of charging. | | | | | | | | | | | | | | | |
| 7 | Capacitance | Within the specified tolerance. | The capacitance/D.F. should be measured at reference temperature at the frequency and voltage shown in the table. | | | | | | | | | | | | | | | |
| 8 | Dissipation Factor (D.F.) | R7 : W.V. 25Vmin. : 0.025 max. W.V. 16/10V : 0.035 max. | <table border="1"> <tr> <td>Frequency</td> <td>1±0.1kHz</td> </tr> <tr> <td>Voltage</td> <td>1±0.2Vrms</td> </tr> </table> | Frequency | 1±0.1kHz | Voltage | 1±0.2Vrms | | | | | | | | | | | |
| Frequency | 1±0.1kHz | | | | | | | | | | | | | | | | | |
| Voltage | 1±0.2Vrms | | | | | | | | | | | | | | | | | |
| 9 | Capacitance Temperature Characteristics | No bias R7 : Within ±15% (-55°C to +125°C) | <p>The capacitance change should be measured after 5 min. at each specified temp. stage.</p> <p>The ranges of capacitance change compared with the Reference Temperature value over the temperature ranges shown in the table should be within the specified ranges.*</p> <table border="1"> <thead> <tr> <th>Step</th> <th>Temperature (°C)</th> </tr> </thead> <tbody> <tr> <td>1</td> <td>25±2</td> </tr> <tr> <td>2</td> <td>-55±3</td> </tr> <tr> <td>3</td> <td>25±2</td> </tr> <tr> <td>4</td> <td>125±3</td> </tr> </tbody> </table> <p>*Initial measurement for high dielectric constant type Perform a heat treatment at 150 +0/-10°C for one hour and then let sit for 24±2 hours at room temperature. Perform the initial measurement.</p> | Step | Temperature (°C) | 1 | 25±2 | 2 | -55±3 | 3 | 25±2 | 4 | 125±3 | | | | | |
| Step | Temperature (°C) | | | | | | | | | | | | | | | | | |
| 1 | 25±2 | | | | | | | | | | | | | | | | | |
| 2 | -55±3 | | | | | | | | | | | | | | | | | |
| 3 | 25±2 | | | | | | | | | | | | | | | | | |
| 4 | 125±3 | | | | | | | | | | | | | | | | | |
| 10 | Mechanical Strength | Bond Strength Pull force : 0.03N min. | MIL-STD-883 Method 2011 Condition D Mount the capacitor on a gold metallized alumina substrate with Au-Sn (80/20) and bond a 25mm (0.001 inch) gold wire to the capacitor terminal using an ultrasonic ball bond. Then, pull wire. | | | | | | | | | | | | | | | |
| | | Die Shear Strength Die Shear force : 2N min. | MIL-STD-883 Method 2019 Mount the capacitor on a gold metallized alumina substrate with Au-Sn (80/20). Apply the force parallel to the substrate. | | | | | | | | | | | | | | | |
| 11 | Vibration Resistance | Appearance | Ramp frequency from 10 to 55Hz then return to 10Hz all within 1 minute. Amplitude: 1.5 mm (0.06 inch) max. total excursion. Apply this motion for a period of 2 hours in each of 3 mutually perpendicular directions (total 6 hours). | | | | | | | | | | | | | | | |
| | | Capacitance | | | | | | | | | | | | | | | | |
| | | D.F. | | | | | | | | | | | | | | | | |
| 12 | Temperature Cycle | Appearance | The capacitor should be set for 24±2 hours at room temperature after one hour of heat treatment at 150+0/-10°C, then measure for the initial measurement. Fix the capacitor to the supporting jig in the same manner and under the same conditions as (11) and conduct the five cycles according to the temperatures and time shown in the following table. Set it for 24±2 hours at room temperature, then measure. | | | | | | | | | | | | | | | |
| | | Capacitance Change | | | | | | | | | | | | | | | | |
| | | D.F. | | | | | | | | | | | | | | | | |
| | | I.R. | | | | | | | | | | | | | | | | |
| | | Dielectric Strength | | | | | | | | | | | | | | | | |
| | | | <table border="1"> <thead> <tr> <th>Step</th> <th>1</th> <th>2</th> <th>3</th> <th>4</th> </tr> </thead> <tbody> <tr> <td>Temp. (°C)</td> <td>Min. Operating Temp. +0/-3</td> <td>Room Temp.</td> <td>Max. Operating Temp. +3/-0</td> <td>Room Temp.</td> </tr> <tr> <td>Time (min.)</td> <td>30+/-3</td> <td>2 to 3</td> <td>30+/-3</td> <td>2 to 3</td> </tr> </tbody> </table> | Step | 1 | 2 | 3 | 4 | Temp. (°C) | Min. Operating Temp. +0/-3 | Room Temp. | Max. Operating Temp. +3/-0 | Room Temp. | Time (min.) | 30+/-3 | 2 to 3 | 30+/-3 | 2 to 3 |
| Step | 1 | 2 | 3 | 4 | | | | | | | | | | | | | | |
| Temp. (°C) | Min. Operating Temp. +0/-3 | Room Temp. | Max. Operating Temp. +3/-0 | Room Temp. | | | | | | | | | | | | | | |
| Time (min.) | 30+/-3 | 2 to 3 | 30+/-3 | 2 to 3 | | | | | | | | | | | | | | |

Mounting for testing: The capacitors should be mounted on the substrate as shown below using die bonding. when tests No. 11 to 15 are performed.

Continued on the following page. 

GMD Series Specifications and Test Methods (1)

Continued from the preceding page.

**When no "*" is added in PNs table, please refer to GMD Series Specifications and Test Methods (1).
 When "*" is added in PNs table, please refer to GMD Series Specifications and Test Methods (2).**

| No. | Item | Specifications | Test Method |
|-----|-------------------------|--------------------|---|
| 13 | Humidity (Steady State) | Appearance | Set the capacitor for 500±12 hours at 40±2°C, in 90 to 95% humidity. Take it out and set it for 24±2 hours at room temperature, then measure. |
| | | Capacitance Change | |
| | | D.F. | |
| | | I.R. | |
| 14 | Humidity Load | Appearance | Apply the rated voltage for 500±12 hours at 40±2°C, in 90 to 95% humidity and set it for 24±2 hours at room temperature, then measure. The charge/discharge current is less than 50mA. |
| | | Capacitance Change | |
| | | D.F. | |
| | | I.R. | |
| 15 | High Temperature Load | Appearance | A voltage treatment should be given to the capacitor, in which a DC voltage of 200% the rated voltage is applied for one hour at the maximum operating temperature; ±3°C then it should be set for 24±2 hours at room temperature and the initial measurement should be conducted. Then apply the above-mentioned voltage continuously for 1000±12 hours at the same temperature, remove it from the bath, and set it for 24±2 hours at room temperature, then measure. The charge/discharge current is less than 50mA. |
| | | Capacitance Change | |
| | | D.F. | |
| | | I.R. | |

Mounting for testing: The capacitors should be mounted on the substrate as shown below using die bonding. when tests No. 11 to 15 are performed.

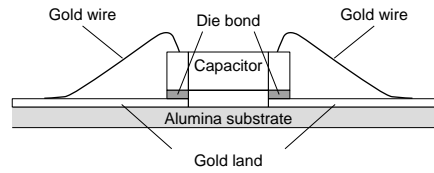
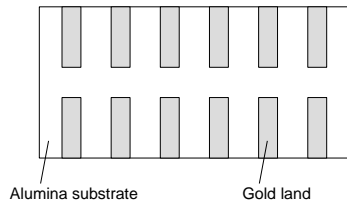

For General GRM Series

Array GMM Series

Low ESL LL□ Series

High-Q GJM Series

High Frequency GOM Series

Monolithic Microchip GMA Series

For Bonding GMD Series

Product Information

GMD Series Specifications and Test Methods (2)

When no "*" is added in PNs table, please refer to GMD Series Specifications and Test Methods (1).
 When "*" is added in PNs table, please refer to GMD Series Specifications and Test Methods (2).

| No. | Item | Specifications | Test Method | | | | | | | | | | | | | | | |
|----------------------|---|----------------------------------|--|---|-----------|------------------|----------------------|------------|---------------|----------------------------|------------|----------------------------|------------|-------------|--------|--------|--------|--------|
| 1 | Operating Temperature Range | R6 : -55°C to 85°C | Reference Temperature : 25°C | | | | | | | | | | | | | | | |
| 2 | Rated Voltage | See the previous pages. | The rated voltage is defined as the maximum voltage that may be applied continuously to the capacitor. When AC voltage is superimposed on DC voltage, V ^{P-P} or V ^{O-P} , whichever is larger, should be maintained within the rated voltage range. | | | | | | | | | | | | | | | |
| 3 | Appearance | No defects or abnormalities. | Visual inspection. | | | | | | | | | | | | | | | |
| 4 | Dimensions | Within the specified dimensions. | Using calipers. | | | | | | | | | | | | | | | |
| 5 | Dielectric Strength | No defects or abnormalities. | No failure should be observed when 250% of the rated voltage is applied between the terminations for 1 to 5 seconds, provided the charge/discharge current is less than 50mA. | | | | | | | | | | | | | | | |
| 6 | Insulation Resistance | More than 50Ω · F | The insulation resistance should be measured with a DC voltage not exceeding the rated voltage at normal temperature and humidity and within 1 minutes of charging. | | | | | | | | | | | | | | | |
| 7 | Capacitance | Within the specified tolerance. | The capacitance/D.F. should be measured at reference temperature at the frequency and voltage shown in the table. | | | | | | | | | | | | | | | |
| 8 | Dissipation Factor (D.F.) | R6 : 0.1 max. | <table border="1"> <thead> <tr> <th>Capacitance</th> <th>Frequency</th> <th>Voltage</th> </tr> </thead> <tbody> <tr> <td>C ≤ 10μF (10Vmin.)*1</td> <td>1 ± 0.1kHz</td> <td>1.0 ± 0.2Vrms</td> </tr> <tr> <td>C ≤ 10μF (6.3Vmax.)</td> <td>1 ± 0.1kHz</td> <td>0.5 ± 0.1Vrms</td> </tr> </tbody> </table> | Capacitance | Frequency | Voltage | C ≤ 10μF (10Vmin.)*1 | 1 ± 0.1kHz | 1.0 ± 0.2Vrms | C ≤ 10μF (6.3Vmax.) | 1 ± 0.1kHz | 0.5 ± 0.1Vrms | | | | | | |
| | | | Capacitance | Frequency | Voltage | | | | | | | | | | | | | |
| C ≤ 10μF (10Vmin.)*1 | 1 ± 0.1kHz | 1.0 ± 0.2Vrms | | | | | | | | | | | | | | | | |
| C ≤ 10μF (6.3Vmax.) | 1 ± 0.1kHz | 0.5 ± 0.1Vrms | | | | | | | | | | | | | | | | |
| | | | *1 GMD155 R6 1A 124 to 224 are applied to 0.5 ± 0.1 Vrms. | | | | | | | | | | | | | | | |
| 9 | Capacitance Temperature Characteristics | No bias | R6 : Within ±15% (-55°C to +85°C) The capacitance change should be measured after 5 min. at each specified temp. stage. The ranges of capacitance change compared with the Reference Temperature value over the temperature ranges shown in the table should be within the specified ranges.* | | | | | | | | | | | | | | | |
| | | | | <table border="1"> <thead> <tr> <th>Step</th> <th>Temperature (°C)</th> </tr> </thead> <tbody> <tr> <td>1</td> <td>25 ± 2</td> </tr> <tr> <td>2</td> <td>-55 ± 3</td> </tr> <tr> <td>3</td> <td>25 ± 2</td> </tr> <tr> <td>4</td> <td>85 ± 3</td> </tr> </tbody> </table> | Step | Temperature (°C) | 1 | 25 ± 2 | 2 | -55 ± 3 | 3 | 25 ± 2 | 4 | 85 ± 3 | | | | |
| Step | Temperature (°C) | | | | | | | | | | | | | | | | | |
| 1 | 25 ± 2 | | | | | | | | | | | | | | | | | |
| 2 | -55 ± 3 | | | | | | | | | | | | | | | | | |
| 3 | 25 ± 2 | | | | | | | | | | | | | | | | | |
| 4 | 85 ± 3 | | | | | | | | | | | | | | | | | |
| 10 | Mechanical Strength | Bond Strength | Pull force : 0.03N min. MIL-STD-883 Method 2011 Condition D Mount the capacitor on a gold metallized alumina substrate with Au-Sn (80/20) and bond a 25μm (0.001 inch) gold wire to the capacitor terminal using an ultrasonic ball bond. Then, pull wire. | | | | | | | | | | | | | | | |
| | | Die Shear Strength | Die Shear force : 2N min. MIL-STD-883 Method 2019 Mount the capacitor on a gold metallized alumina substrate with Au-Sn (80/20). Apply the force parallel to the substrate. | | | | | | | | | | | | | | | |
| 11 | Vibration Resistance | Appearance | No defects or abnormalities. | | | | | | | | | | | | | | | |
| | | Capacitance | Within the specified tolerance. | | | | | | | | | | | | | | | |
| | | D.F. | R6 : 0.1 max. | | | | | | | | | | | | | | | |
| 12 | Temperature Sudden Change | Appearance | No defects or abnormalities. | | | | | | | | | | | | | | | |
| | | Capacitance Change | R6 : Within ±7.5% | | | | | | | | | | | | | | | |
| | | D.F. | R6 : 0.1 max. | | | | | | | | | | | | | | | |
| | | I.R. | More than 50Ω · F | | | | | | | | | | | | | | | |
| | | Dielectric Strength | No defects | | | | | | | | | | | | | | | |
| | | | The capacitor should be set for 24 ± 2 hours at room temperature after one hour of heat treatment at 150 + 0/-10°C, then measure for the initial measurement. Fix the capacitor to the supporting jig in the same manner and under the same conditions as (11) and conduct the five cycles according to the temperatures and time shown in the following table. Set it for 24 ± 2 hours at room temperature, then measure. | | | | | | | | | | | | | | | |
| | | | <table border="1"> <thead> <tr> <th>Step</th> <th>1</th> <th>2</th> <th>3</th> <th>4</th> </tr> </thead> <tbody> <tr> <td>Temp. (°C)</td> <td>Min. Operating Temp. +0/-3</td> <td>Room Temp.</td> <td>Max. Operating Temp. +3/-0</td> <td>Room Temp.</td> </tr> <tr> <td>Time (min.)</td> <td>30 ± 3</td> <td>2 to 3</td> <td>30 ± 3</td> <td>2 to 3</td> </tr> </tbody> </table> | Step | 1 | 2 | 3 | 4 | Temp. (°C) | Min. Operating Temp. +0/-3 | Room Temp. | Max. Operating Temp. +3/-0 | Room Temp. | Time (min.) | 30 ± 3 | 2 to 3 | 30 ± 3 | 2 to 3 |
| Step | 1 | 2 | 3 | 4 | | | | | | | | | | | | | | |
| Temp. (°C) | Min. Operating Temp. +0/-3 | Room Temp. | Max. Operating Temp. +3/-0 | Room Temp. | | | | | | | | | | | | | | |
| Time (min.) | 30 ± 3 | 2 to 3 | 30 ± 3 | 2 to 3 | | | | | | | | | | | | | | |

Mounting for testing: The capacitors should be mounted on the substrate as shown below using die bonding. when tests No. 11 to 14 are performed.

Continued on the following page. 

GMD Series Specifications and Test Methods (2)

☐ Continued from the preceding page.

**When no "*" is added in PNs table, please refer to GMD Series Specifications and Test Methods (1).
 When "*" is added in PNs table, please refer to GMD Series Specifications and Test Methods (2).**

| No. | Item | Specifications | Test Method |
|-----|---|---------------------|---|
| 13 | High Temperature High Humidity (Steady) | Appearance | Apply the rated voltage for 500±12 hours at 40±2°C, in 90 to 95% humidity and set it for 24±2 hours at room temperature, then measure. The charge/discharge current is less than 50mA. • Initial measurement Perform a heat treatment at 150+0/-10°C for one hour and then let sit for 24±2 hours at room temperature. Perform the initial measurement. • Measurement after test Perform a heat treatment at 150+0/-10°C for one hour and then let sit for 24±2 hours at room temperature, then measure. |
| | Capacitance Change | R6 : Within ±12.5% | |
| | D.F. | R6 : 0.2 max. | |
| | I.R. | More than 12.5Ω · F | |
| 14 | Durability | Appearance | Apply 150%*2 of the rated voltage for 1000±12 hours at the maximum operating temperature ±3°C. Let sit for 24±2 hours at room temperature, then measure. The charge/ discharge current is less than 50mA. *2 GMD155 R6 1A 274 to 474 are applied to 120%. • Initial measurement Perform a heat treatment at 150+0/-10°C for one hour and then let sit for 24±2 hours at room temperature. Perform the initial measurement. • Measurement after test Perform a heat treatment at 150+0/-10°C for one hour and then let sit for 24±2 hours at room temperature, then measure. |
| | Capacitance Change | R6 : Within ±12.5% | |
| | D.F. | R6 : 0.2 max. | |
| | I.R. | More than 25Ω · F | |

Mounting for testing: The capacitors should be mounted on the substrate as shown below using die bonding. when tests No. 11 to 14 are performed.

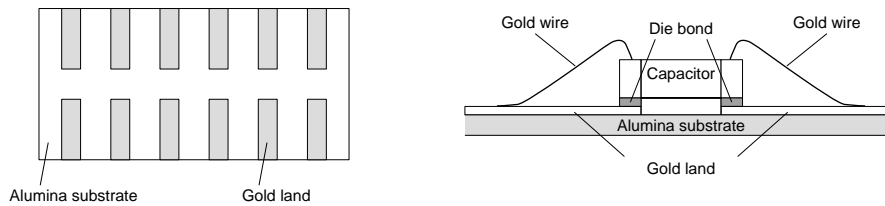

For General GRM Series

Array GMM Series

Low ESL LL□ Series

High-Q GJM Series

High Frequency GOM Series

Monolithic Microchip GMA Series

For Bonding GMD Series

Product Information

Package

Minimum Quantity Guide

| Part Number | Dimensions (mm) | | | Quantity (pcs.) | | | | Bulk Case | Bulk Bag | | |
|----------------------|-----------------|-------|----------|-----------------|----------------------|----------------------|----------------------|-----------|----------------------|-------------------|-------|
| | L | W | T | ø180mm Reel | | ø330mm Reel | | | | | |
| Packaging Code | | | | Paper Tape | Embossed Tape | Paper Tape | Embossed Tape | C | Bulk : B Tray : T | | |
| For General Purpose | GRM02 | 0.4 | 0.2 | 0.2 | - | 40,000 ¹⁾ | - | - | - | 1,000 | |
| | GRM03 | 0.6 | 0.3 | 0.3 | 15,000 | - | 50,000 | - | - | 1,000 | |
| | GRM15 | 1.0 | 0.5 | 0.25/0.3 | 10,000 | - | 50,000 | - | - | 1,000 | |
| | | | | 0.5 | 10,000 | - | 50,000 | - | 50,000 ²⁾ | 1,000 | |
| | GRM18 | 1.6 | 0.8 | 0.5 | 4,000 | - | 10,000 | - | - | 1,000 | |
| | | | | 0.8 | 4,000 | - | 10,000 | - | 15,000 ²⁾ | 1,000 | |
| | GRM21 | 2.0 | 1.25 | 0.6 | 4,000 | - | 10,000 | - | 10,000 | 1,000 | |
| | | | | 0.85 | 4,000 | - | 10,000 | - | - | 1,000 | |
| | GRM31 | 3.2 | 1.6 | 1.0/1.25 | - | 3,000 | - | 10,000 | 5,000 ²⁾ | 1,000 | |
| | | | | 0.6/0.85 | 4,000 | - | 10,000 | - | - | 1,000 | |
| | | | | 1.15 | - | 3,000 | - | 10,000 | - | 1,000 | |
| | GRM32 | 3.2 | 2.5 | 1.6 | - | 2,000 | - | 6,000 | - | 1,000 | |
| | | | | 0.85 | 4,000 | - | 10,000 | - | - | 1,000 | |
| | | | | 1.15 | - | 3,000 | - | 10,000 | - | 1,000 | |
| | | | | 1.35 | - | 2,000 | - | 8,000 | - | 1,000 | |
| | GRM43 | 4.5 | 3.2 | 1.6 | - | 2,000 | - | 6,000 | - | 1,000 | |
| | | | | 1.8/2.0 | - | 1,000 | - | 4,000 | - | 1,000 | |
| | | | | 2.5 | - | 1,000 | - | 4,000 | - | 1,000 | |
| | GRM55 | 5.7 | 5.0 | 1.15 | - | 1,000 | - | 5,000 | - | 1,000 | |
| | | | | 1.35/1.6 | - | 1,000 | - | 4,000 | - | 1,000 | |
| 1.8/2.0 | | | | - | 500 | - | 2,000 | - | 1,000 | | |
| High Power Type | GJM03 | 0.6 | 0.3 | 0.3 | 15,000 | - | 50,000 | - | - | 1,000 | |
| | GJM15 | 1.0 | 0.5 | 0.5 | 10,000 | - | 50,000 | - | 50,000 | 1,000 | |
| High Frequency | QQM18 | 1.6 | 0.8 | 0.7/0.8 | 4,000 | - | 10,000 | - | - | 1,000 | |
| | QQM21 | 2.0 | 1.25 | 0.85 | 4,000 | - | 10,000 | - | - | 1,000 | |
| | QQM22 | 2.8 | 2.8 | 1.15 | - | 1,000 | - | 4,000 | - | 1,000 | |
| Microchip | GMA0D | 0.38 | 0.38 | 0.3 | - | - | - | - | - | 400 ³⁾ | |
| | GMA05 | 0.5 | 0.5 | 0.35 | - | - | - | - | - | 400 ³⁾ | |
| | GMA08 | 0.8 | 0.8 | 0.5 | - | - | - | - | - | 400 ³⁾ | |
| | GMD03 | 0.6 | 0.3 | 0.3 | 15,000 | - | 50,000 | - | - | 1,000 | |
| Array | GMD15 | 1.0 | 0.5 | 0.5 | 10,000 | - | 50,000 | - | - | 1,000 | |
| | GNM0M | 0.9 | 0.6 | 0.45 | 10,000 | - | 50,000 | - | - | 1,000 | |
| | GNM1M | 1.37 | 1.0 | 0.5/0.6/0.8 | 4,000 | - | 10,000 | - | - | 1,000 | |
| Monolithic Microchip | GMA Series | GMA21 | 2.0 | 1.25 | 0.5/0.6/0.85 | 4,000 | - | 10,000 | - | - | 1,000 |
| | | | 0.8/0.85 | 4,000 | - | 10,000 | - | - | 1,000 | | |
| | GMA Series | GMA31 | 3.2 | 1.6 | 1.0/1.15 | - | 3,000 | - | 10,000 | - | 1,000 |
| | | | | | - | - | - | - | - | - | - |
| Low ESL | LLL15 | 0.5 | 1.0 | 0.3 | 10,000 ⁴⁾ | - | 50,000 ⁴⁾ | - | - | 1,000 | |
| | LLL18/LLR18 | 0.8 | 1.6 | 0.5 | - | 4,000 | - | 10,000 | - | 1,000 | |
| | | | | 0.5/0.6 | - | 4,000 | - | 10,000 | - | 1,000 | |
| | LLL21 | 1.25 | 2.0 | 0.85 | - | 3,000 | - | 10,000 | - | 1,000 | |
| | | | | 0.5/0.7 | - | 4,000 | - | 10,000 | - | 1,000 | |
| | LLL31 | 1.6 | 3.2 | 1.15 | - | 3,000 | - | 10,000 | - | 1,000 | |
| | | | | 0.5 | - | 4,000 | - | 10,000 | - | 1,000 | |
| | LLA18 | 1.6 | 0.8 | 0.5 | - | 4,000 | - | 10,000 | - | 1,000 | |
| | | | | 0.5 | - | 4,000 | - | 10,000 | - | 1,000 | |
| | LLA21 | 2.0 | 1.25 | 0.85 | - | 3,000 | - | 10,000 | - | 1,000 | |
| | | | | 0.5 | - | 4,000 | - | 10,000 | - | 1,000 | |
| | | | | 0.85 | - | 3,000 | - | 10,000 | - | 1,000 | |
| LLA31 | 3.2 | 1.6 | 0.5 | - | 4,000 | - | 10,000 | - | 1,000 | | |
| | | | 0.85 | - | 3,000 | - | 10,000 | - | 1,000 | | |
| | | | 1.15 | - | 3,000 | - | 10,000 | - | 1,000 | | |
| LLM21 | 2.0 | 1.25 | 0.5 | - | 4,000 | - | 10,000 | - | 1,000 | | |
| LLM31 | 3.2 | 1.6 | 0.5 | - | 4,000 | - | 10,000 | - | 1,000 | | |

1) 4mm width, 1mm pitch Embossed Taping.
 2) There are parts without bulk case packaging.
 3) Tray
 4) LLL15: ø180mm Reel Paper Taping Packaging Code: E, ø330mm Reel Paper Taping Packaging Code: F

Continued on the following page. 



Package

Continued from the preceding page.

■ Tape Carrier Packaging

(1) Dimensions of Reel

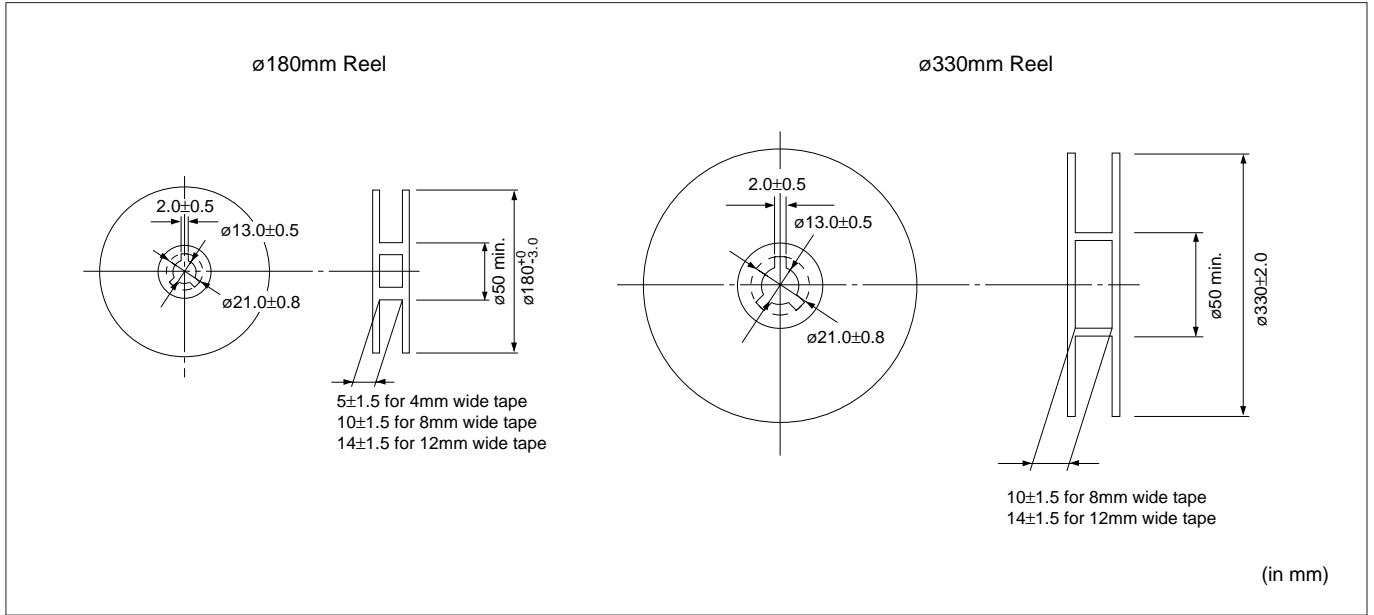

(2) Dimensions of Paper Tape

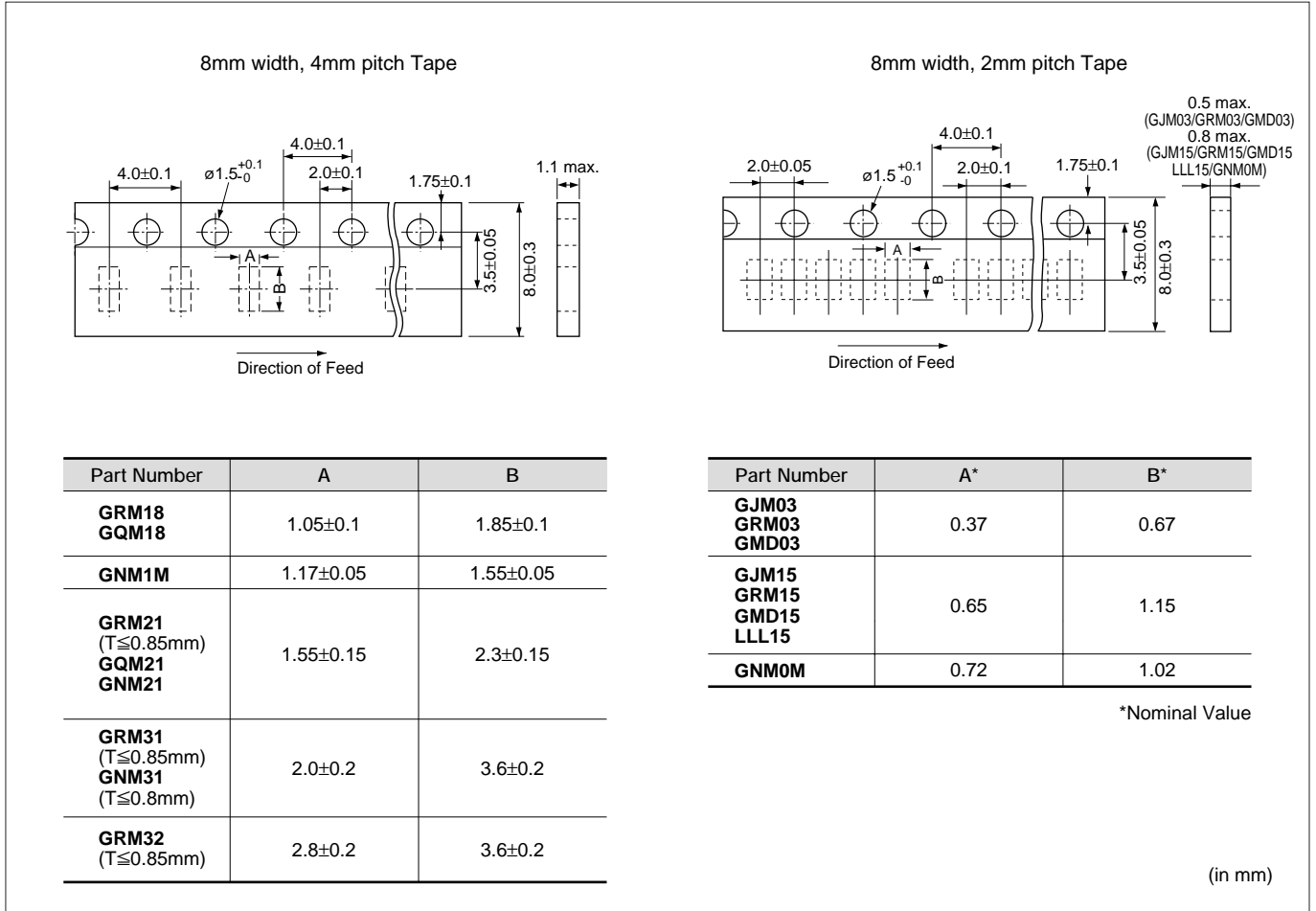

Continued on the following page. ↗

Package

Continued from the preceding page.

(3) Dimensions of Embossed Tape

4mm width, 1mm pitch Tape

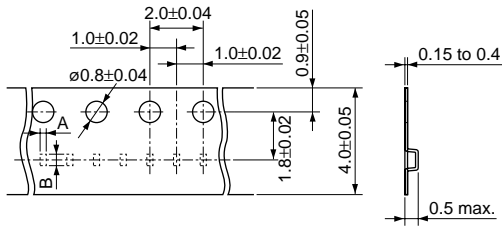

| Part Number | A* | B* |
|-------------|------|------|
| GRM02 | 0.23 | 0.43 |

*Nominal Value

8mm width, 4mm pitch Tape

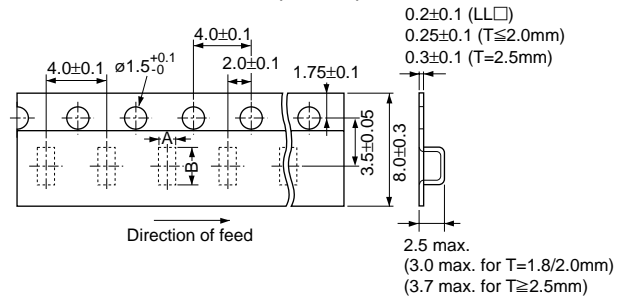

| Part Number | A | B |
|--|----------|----------|
| LLL18, LLR18 LLA18 | 1.05±0.1 | 1.85±0.1 |
| GRM21 (T≥1.0mm) LLL21 LLA21, LLM21 | 1.45±0.2 | 2.25±0.2 |
| GRM31 (T≥1.15mm) LLL31 LLA31, LLM31 GJM31 (T≥1.0mm) | 1.9±0.2 | 3.5±0.2 |
| GRM32 (T≥1.0mm) | 2.8±0.2 | 3.5±0.2 |
| GQM22 | 2.8* | 3.5* |

*Nominal Value

12mm width, 8mm pitch Tape

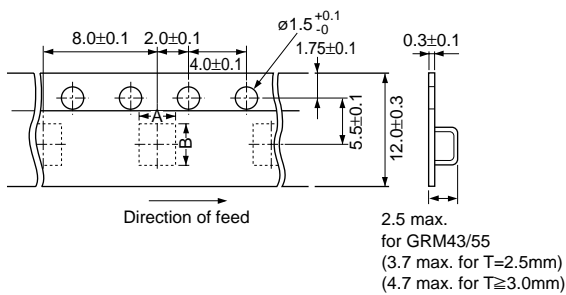

| Part Number | A* | B* |
|-------------|-----|-----|
| GRM43 | 3.6 | 4.9 |
| GRM55 | 5.2 | 6.1 |

*Nominal Value

(in mm)

(4) Taping Method

- Tapes for capacitors are wound clockwise. The sprocket holes are to the right as the tape is pulled toward the user.
- Part of the leader and part of the empty tape should be attached to the end of the tape as follows.
- The top tape and base tape are not attached at the end of the tape for a minimum of 5 pitches.
- Missing capacitors number within 0.1% of the number per reel or 1 pc, whichever is greater, and are not continuous.
- The top tape and bottom tape should not protrude beyond the edges of the tape and should not cover sprocket holes.
- Cumulative tolerance of sprocket holes, 10 pitches: ±0.3mm.
- Peeling off force: 0.1 to 0.6N* in the direction shown at right.

*GRM02
GRM03
GJM03
GMD03 : 0.05 to 0.5N

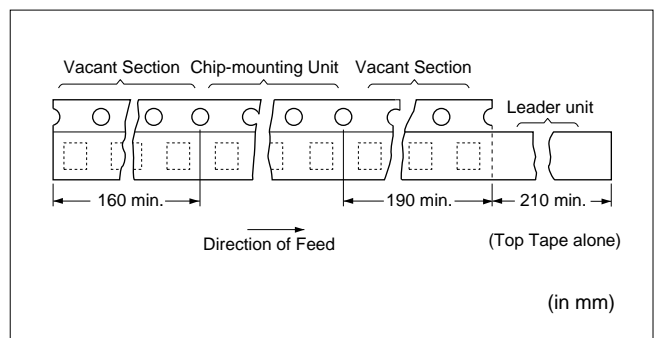

(in mm)

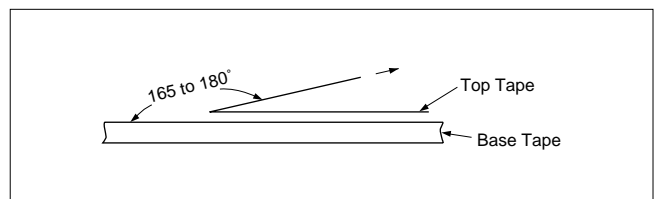

Continued on the following page.

Package

☐ Continued from the preceding page.

■ Dimensions of Bulk Case Packaging

The bulk case uses antistatic materials. Please contact Murata for details.

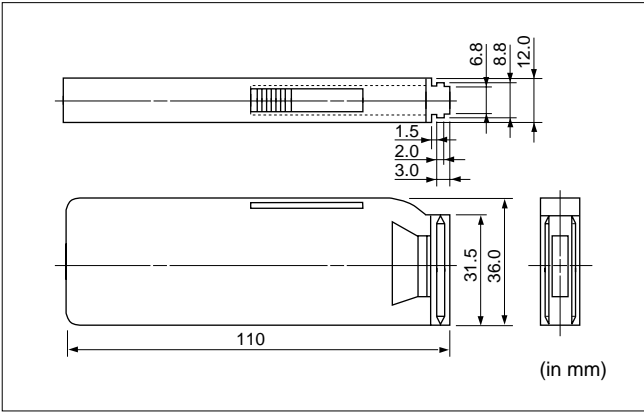

| |
|---------------------------------|
| For General GRM Series |
| Array GNM Series |
| Low ESL LL□ Series |
| High-Q GJM Series |
| High Frequency GOM Series |
| Monolithic Microchip GMA Series |
| For Bonding GMD Series |
| Product Information Package |

⚠ Caution

■ Storage and Operation conditions

1. The performance of chip monolithic ceramic capacitors may be affected by the storage conditions.

1-1. Store capacitors in the following conditions:

Temperature of +5°C to +40°C and a Relative Humidity of 20% to 70%.

- (1) Sunlight, dust, rapid temperature changes, corrosive gas atmosphere or high temperature and humidity conditions during storage may affect the solderability and the packaging performance. Please use product within six months of receipt.
- (2) Please confirm solderability before using after six months. Store the capacitors without opening the original bag. Even if the storage period is short, do not exceed the specified atmospheric conditions.

- 1-2. Corrosive gas can react with the termination (external) electrodes or lead wires of capacitors, and result in poor solderability. Do not store the capacitors in an atmosphere consisting of corrosive gas (e.g., hydrogen sulfide, sulfur dioxide, chlorine, ammonia gas, etc.).
- 1-3. Due to moisture condensation caused by rapid humidity changes, or the photochemical change caused by direct sunlight on the terminal electrodes and/or the resin/epoxy coatings, the solderability and electrical performance may deteriorate. Do not store capacitors under direct sunlight or in high humidity conditions.

For General
GRM Series

Array
GMM Series

Low ESL
LL□ Series

High-Q
GJM Series

High Frequency
GOM Series

Monolithic Microchip
GMA Series

For Bonding
GMD Series

Product Information
⚠ Caution



Rating

1. Temperature Dependent Characteristics

1. The electrical characteristics of the capacitor can change with temperature.

1-1. For capacitors having larger temperature dependency, the capacitance may change with temperature changes.

The following actions are recommended in order to ensure suitable capacitance values.

(1) Select a suitable capacitance for the operating temperature range.

(2) The capacitance may change within the rated temperature.

When you use a high dielectric constant type capacitor in a circuit that needs a tight (narrow) capacitance tolerance. (e. g., a time constant circuit), please carefully consider the characteristics of these capacitors, such as their aging, voltage, and temperature characteristics. And check capacitors using your actual appliances at the intended environment and operating conditions.

Typical Temperature Characteristics R6(X5R)

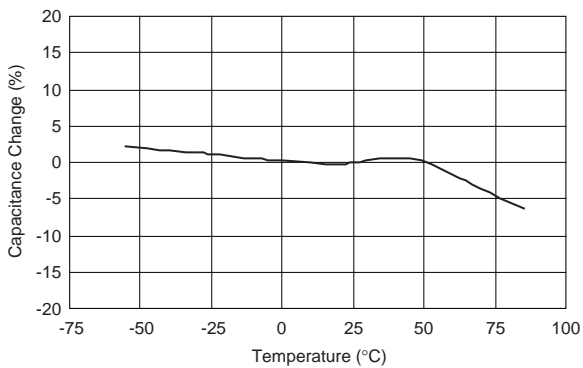

Typical Temperature Characteristics R7(X7R)

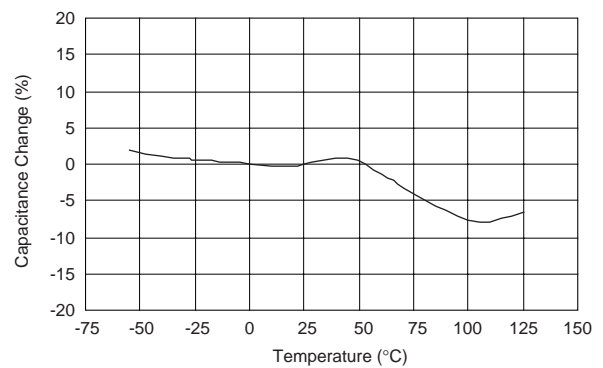

Typical Temperature Characteristics F5(Y5V)

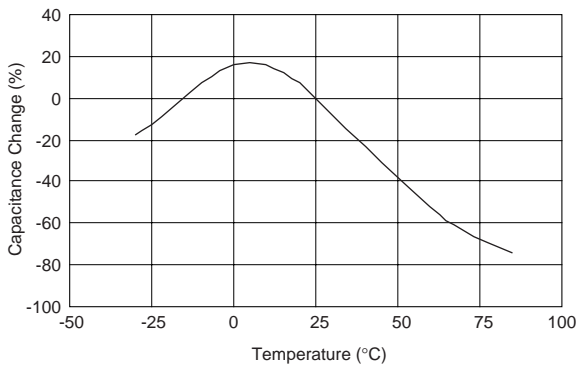

2. Measurement of Capacitance

1. Measure capacitance with the voltage and the frequency specified in the product specifications.

1-1. The output voltage of the measuring equipment may decrease occasionally when capacitance is high. Please confirm whether a prescribed measured voltage is impressed to the capacitor.

1-2. The capacitance values of high dielectric constant type capacitors change depending on the AC voltage applied. Please consider the AC voltage characteristics when selecting a capacitor to be used in an AC circuit.

Continued on the following page.

⚠ Caution

☐ Continued from the preceding page.

3. Applied Voltage

1. Do not apply a voltage to the capacitor that exceeds the rated voltage as called out in the specifications.

1-1. Applied voltage between the terminals of a capacitor shall be less than or equal to the rated voltage.

(1) When AC voltage is superimposed on DC voltage, the zero-to-peak voltage shall not exceed the rated DC voltage.

When AC voltage or pulse voltage is applied, the peak-to-peak voltage shall not exceed the rated DC voltage.

(2) Abnormal voltages (surge voltage, static electricity, pulse voltage, etc.) shall not exceed the rated DC voltage.

Typical Voltage Applied to the DC Capacitor

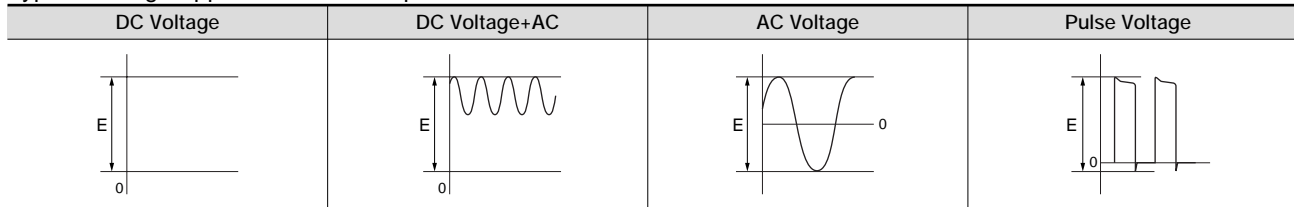

(E: Maximum possible applied voltage.)

1-2. Influence of overvoltage

Overvoltage that is applied to the capacitor may result in an electrical short circuit caused by the breakdown of the internal dielectric layers.

The time duration until breakdown depends on the applied voltage and the ambient temperature.

4. Applied Voltage and Self-heating Temperature

1. When the capacitor is used in a high-frequency voltage, pulse voltage, application, be sure to take into account self-heating may be caused by resistant factors of the capacitor.

1-1. The load should be contained to the level such that when measuring at atmospheric temperature of 25°C, the product's self-heating remains below 20°C and surface temperature of the capacitor in the actual circuit remains within the maximum operating temperature.

Continued on the following page. ☐



Continued from the preceding page.

5. DC Voltage and AC Voltage Characteristics

1. The capacitance value of a high dielectric constant type capacitor changes depending on the DC voltage applied. Please consider the DC voltage characteristics when a capacitor is selected for use in a DC circuit.

1-1. The capacitance of ceramic capacitors may change sharply depending on the applied voltage (see figure).

Please confirm the following in order to secure the capacitance.

- (1) Whether the capacitance change caused by the applied voltage is within the range allowed or not.
- (2) In the DC voltage characteristics, the rate of capacitance change becomes larger as voltage increases, even if the applied voltage is below the rated voltage. When a high dielectric constant type capacitor is in a circuit that needs a tight (narrow) capacitance tolerance (e. g., a time constant circuit), please carefully consider the characteristics of these capacitors, such as their aging, voltage, and temperature characteristics. In addition, check capacitors using your actual appliances at the intended environment and operating conditions.

2. The capacitance values of high dielectric constant type capacitors change depending on the AC voltage applied. Please consider the AC voltage characteristics when selecting a capacitor to be used in an AC circuit.

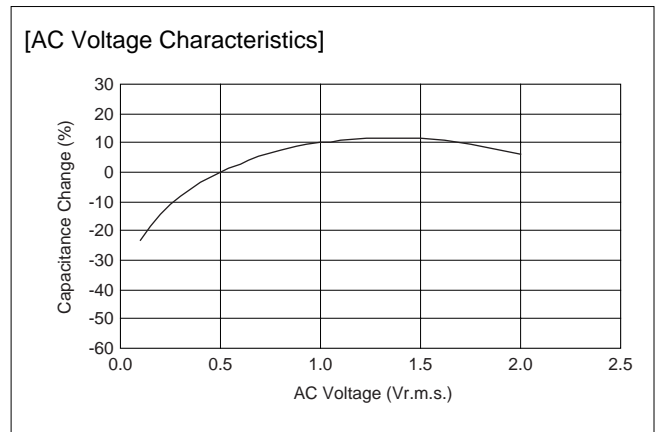
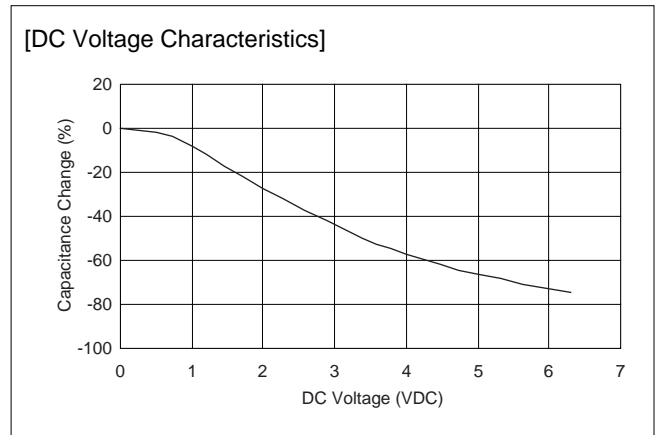

6. Capacitance Aging

1. The high dielectric constant type capacitors have the characteristic in which the capacitance value decreases with passage of time.

When you use a high dielectric constant type capacitors in a circuit that needs a tight (narrow) capacitance tolerance (e. g., a time constant circuit), please carefully consider the characteristics of these capacitors, such as their aging, voltage, and temperature characteristics. In addition, check capacitors using your actual appliances at the intended environment and operating conditions.

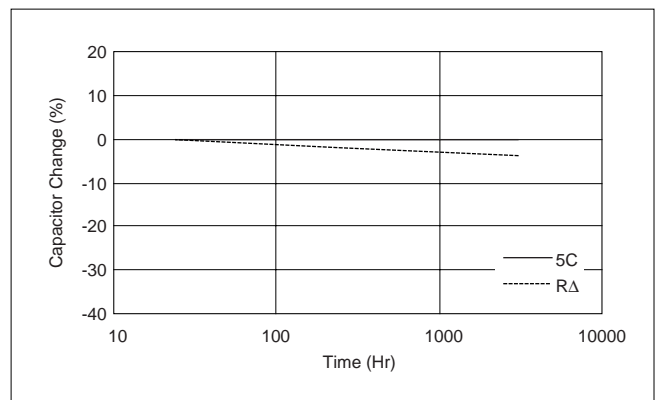

Continued on the following page. ↗

For General GRM Series

Array GNM Series

Low ESL LL Series

High-Q GJM Series

High Frequency GOM Series

Monolithic Microchip GMA Series

For Bonding GMD Series

Product Information △Caution

⚠Caution

☑ Continued from the preceding page.

7. Vibration and Shock

1. The capacitor's mechanical stress (vibration and shock) shall be specified for the use environment.
Please confirm the kind of vibration and/or shock, its condition, and any generation of resonance.
Please mount the capacitor so as not to generate resonance, and do not allow any impact on the terminals.
2. Mechanical shock due to being dropped may cause damage or a crack in the dielectric material of the capacitor.
Do not use a dropped capacitor because the quality and reliability may be deteriorated.
3. When printed circuit boards are piled up or handled, the corners of another printed circuit board should not be allowed to hit the capacitor, in order to avoid a crack or other damage to the capacitor.

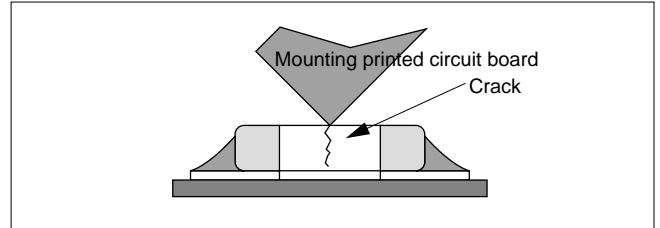
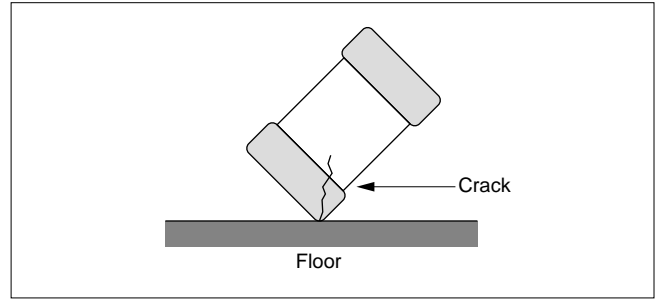

For General
GRM Series

Array
GMM Series

Low ESL
LL□ Series

High-Q
GJM Series

High Frequency
GOM Series

Monolithic Microchip
GMA Series

For Bonding
GMD Series

Product Information
⚠Caution

Caution

■ Soldering and Mounting

1. Mounting Position

1. Confirm the best mounting position and direction that minimizes the stress imposed on the capacitor during flexing or bending the printed circuit board.
 - 1-1. Choose a mounting position that minimizes the stress imposed on the chip during flexing or bending of the board.

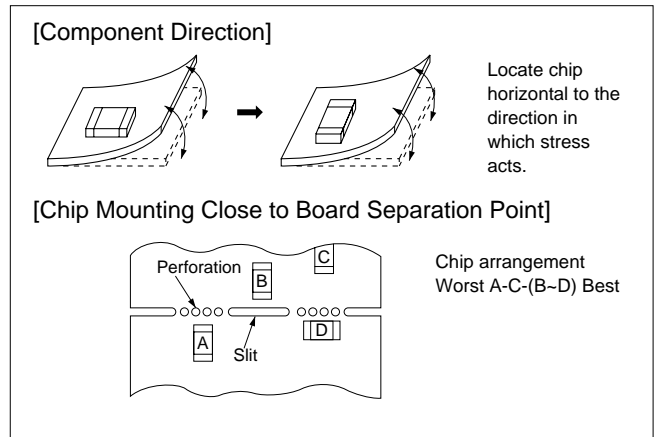

2. Information before Mounting

1. Do not reuse capacitors that were removed from the equipment.
2. Confirm capacitance characteristics under actual applied voltage.
3. Confirm the mechanical stress under actual process and equipment use.
4. Confirm the rated capacitance, rated voltage and other electrical characteristics before assembly.

5. Prior to use, confirm the solderability of capacitors that were in long-term storage.
6. Prior to measuring capacitance, carry out a heat treatment for capacitors that were in long-term storage.
7. The use of Sn-Zn based solder will deteriorate the reliability of the MLCC.
 Please contact our sales representative or product engineers on the use of Sn-Zn based solder in advance.

3. Maintenance of the Mounting (pick and place) Machine

1. Make sure that the following excessive forces are not applied to the capacitors.
 - 1-1. In mounting the capacitors on the printed circuit board, any bending force against them shall be kept to a minimum to prevent them from any bending damage or cracking. Please take into account the following precautions and recommendations for use in your process.
 - (1) Adjust the lowest position of the pickup nozzle so as not to bend the printed circuit board.
 - (2) Adjust the nozzle pressure within a static load of 1N to 3N during mounting.
2. Dirt particles and dust accumulated between the suction nozzle and the cylinder inner wall prevent the nozzle from moving smoothly. This imposes greater force upon the chip during mounting, causing cracked chips. Also the locating claw, when worn out, imposes uneven forces on the chip when positioning, causing cracked chips. The suction nozzle and the locating claw must be maintained, checked and replaced periodically.

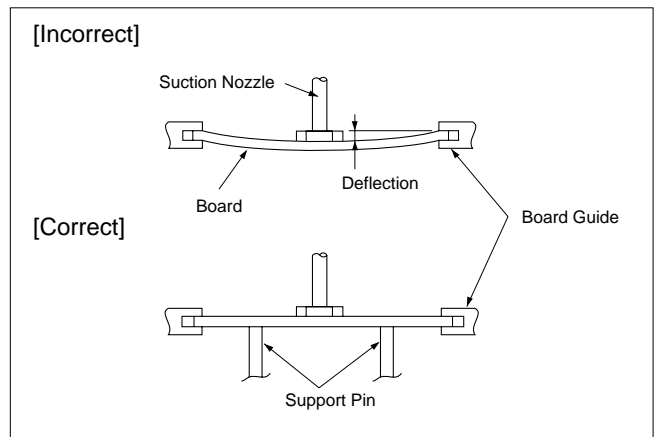

Continued on the following page.

For General GRM Series

Array GNM Series

Low ESL LL□ Series

High-Q GJM Series

High Frequency GOM Series

Monolithic Microchip GMA Series

For Bonding GMD Series

Product Information **Caution**

Caution

Continued from the preceding page.

4-1. Reflow Soldering

- When sudden heat is applied to the components, the mechanical strength of the components will decrease because a sudden temperature change causes deformation inside the components. In order to prevent mechanical damage to the components, preheating is required for both the components and the PCB board. Preheating conditions are shown in table 1. It is required to keep the temperature differential between the solder and the component's surface (ΔT) as small as possible.
- Solderability of Tin plating termination chips might be deteriorated when a low temperature soldering profile where the peak solder temperature is below the melting point of Tin is used. Please confirm the Solderability of Tin plated termination chips before use.
- When components are immersed in solvent after mounting, be sure to maintain the temperature difference (ΔT) between the component and the solvent within the range shown in the table 1.

Table 1

| Part Number | Temperature Differential |
|---|-----------------------------------|
| GRM02/03/15/18/21/31 GJM03/15 LLL15/18/21/31 LLR18 GQM18/21 | $\Delta T \leq 190^\circ\text{C}$ |
| GRM32/43/55 LLA18/21/31 LLM21/31 GNM GQM22 | $\Delta T \leq 130^\circ\text{C}$ |

Recommended Conditions

| | Pb-Sn Solder | | Lead Free Solder |
|------------------|-----------------|--------------|-----------------------|
| | Infrared Reflow | Vapor Reflow | |
| Peak Temperature | 230 to 250°C | 230 to 240°C | 240 to 260°C |
| Atmosphere | Air | Air | Air or N ₂ |

Pb-Sn Solder: Sn-37Pb
 Lead Free Solder: Sn-3.0Ag-0.5Cu

4. Optimum Solder Amount for Reflow Soldering

- Overly thick application of solder paste results in a excessive solder fillet height. This makes the chip more susceptible to mechanical and thermal stress on the board and may cause the chips to crack.
- Too little solder paste results in a lack of adhesive strength on the outer electrode, which may result in chips breaking loose from the PCB.
- Make sure the solder has been applied smoothly to the end surface to a height of 0.2mm* min.

Inverting the PCB

Make sure not to impose any abnormal mechanical shocks to the PCB.

[Standard Conditions for Reflow Soldering]

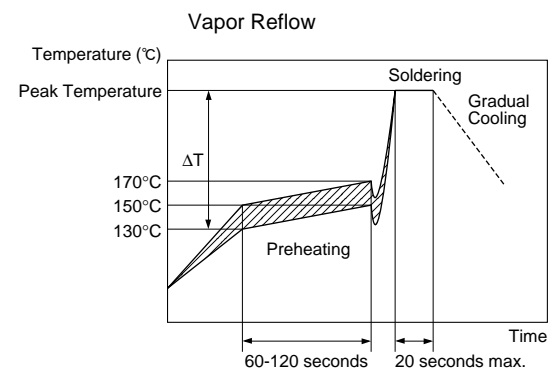
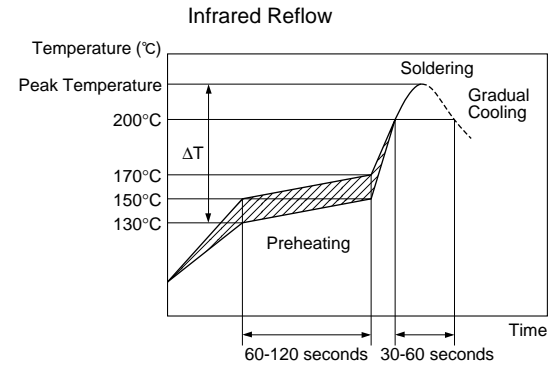

[Allowable Reflow Soldering Temperature and Time]

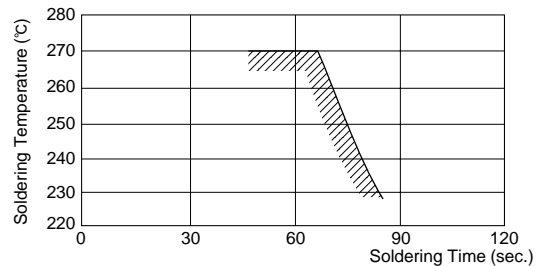

In a case of repeated soldering, the accumulated soldering time must be within the range shown above.

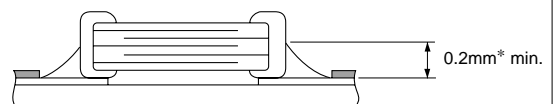

* GRM02/03: 1/3 of Chip Thickness min.

in section

Caution

Continued from the preceding page.

4-2. Flow Soldering

- When sudden heat is applied to the components, the mechanical strength of the components will decrease because a sudden temperature change causes deformation inside the components. In order to prevent mechanical damage in the components, preheating should be required for both of the components and the PCB board.
Preheating conditions are shown in table 2. It is required to keep the temperature differential between the solder and the component's surface (ΔT) as small as possible.
- Excessively long soldering time or high soldering temperature can result in leaching of the outer electrodes, causing poor adhesion or a reduction in capacitance value due to loss of contact between electrodes and end termination.
- When components are immersed in solvent after mounting, be sure to maintain the temperature difference (ΔT) between the component and solvent within the range shown in the table 2.
- Do not apply flow soldering to chips not listed in table 2.

Table 2

| Part Number | Temperature Differential |
|-------------|-----------------------------------|
| GRM18/21/31 | $\Delta T \leq 150^\circ\text{C}$ |
| LLL21/31 | |
| GQM18/21 | |

Recommended Conditions

| | Pb-Sn Solder | Lead Free Solder |
|-----------------------------|--------------|------------------|
| Preheating Peak Temperature | 90 to 110°C | 100 to 120°C |
| Soldering Peak Temperature | 240 to 250°C | 250 to 260°C |
| Atmosphere | Air | N ₂ |

Pb-Sn Solder: Sn-37Pb
Lead Free Solder: Sn-3.0Ag-0.5Cu

5. Optimum Solder Amount for Flow Soldering

- The top of the solder fillet should be lower than the thickness of components. If the solder amount is excessive, the risk of cracking is higher during board bending or any other stressful condition.

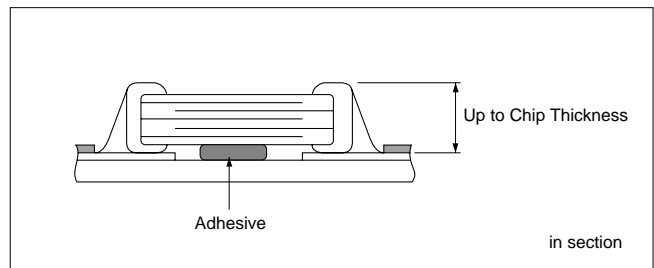
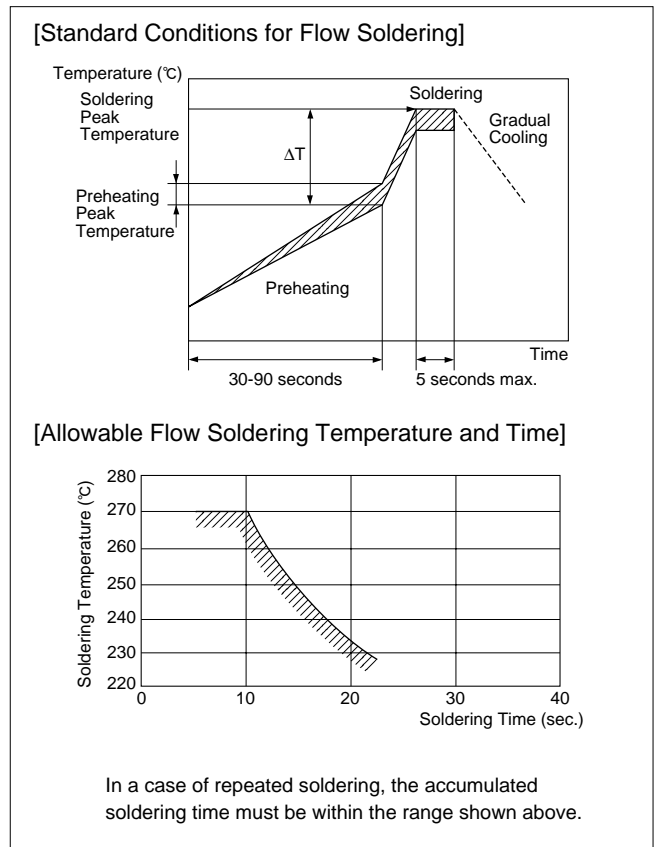

Continued on the following page. ↗

For General GRM Series

Array GNM Series

Low ESL LL□ Series

High-Q GJM Series

High Frequency GOM Series

Monolithic Microchip GMA Series

For Bonding GMD Series

Product Information
△Caution

⚠ Caution

☐ Continued from the preceding page.

4-3. Correction with a Soldering Iron

1. When sudden heat is applied to the components when using a soldering iron, the mechanical strength of the components will decrease because the extreme temperature change can cause deformations inside the components. In order to prevent mechanical damage to the components, preheating is required for both the components and the PCB board. Preheating conditions, (The "Temperature of the Soldering Iron Tip", "Preheating Temperature", "Temperature Differential" between the iron tip and the components and the PCB), should be within the conditions of table 3. It is required to keep the temperature differential between the soldering iron and the component surfaces (ΔT) as small as possible.

2. After soldering, do not allow the component/PCB to rapidly cool down.
3. The operating time for the re-working should be as short as possible. When re-working time is too long, it may cause solder leaching, in turn causing a reduction in the adhesive strength of the terminations.
4. Optimum Solder amount when re-working with a Soldering Iron

4-1. For sizes smaller than 0603, (GRM03/15/18, GJM03/15, GQM18), the top of the solder fillet should be lower than 2/3's of the thickness of the component or 0.5mm whichever is smaller. For 0805 and larger sizes, (GRM21/31/32/43/55, GQM21/22), the top of the solder fillet should be lower than 2/3's of the thickness of the component. If the solder amount is excessive, the risk of cracking is higher during board bending or under any other stressful condition.

4-2. A soldering iron with a tip of $\phi 3\text{mm}$ or smaller should be used. It is also necessary to keep the soldering iron from touching the components during the re-work.

4-3. Solder wire with $\phi 0.5\text{mm}$ or smaller is required for soldering.

4-4. Leaded Component Insertion

1. If the PCB is flexed when leaded components (such as transformers and ICs) are being mounted, chips may crack and solder joints may break.
Before mounting leaded components, support the PCB using backup pins or special jigs to prevent warping.

5. Washing

Excessive ultrasonic oscillation during cleaning can cause the PCBs to resonate, resulting in cracked chips or broken solder joints. Take note not to vibrate PCBs.

Table 3

| Part Number | Temperature of Soldering Iron Tip | Preheating Temperature | Temperature Differential (ΔT) | Atmosphere |
|--|-----------------------------------|------------------------|---|------------|
| GRM03/15/18/21/31 GJM03/15 GQM18/21 | 350°C max. | 150°C min. | $\Delta T \leq 190^\circ\text{C}$ | Air |
| GRM32/43/55 GQM22 | 280°C max. | 150°C min. | $\Delta T \leq 130^\circ\text{C}$ | Air |

*Applicable for both Pb-Sn and Lead Free Solder.
 Pb-Sn Solder: Sn-37Pb
 Lead Free Solder: Sn-3.0Ag-0.5Cu

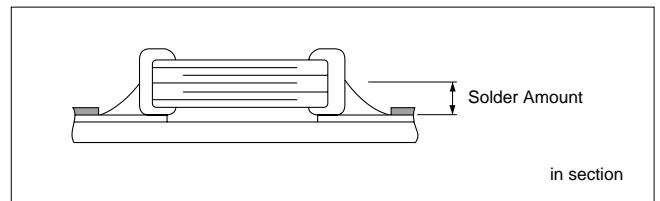

Continued on the following page. ☐

Caution

☐ Continued from the preceding page.

6. Electrical Test on Printed Circuit Board

1. Confirm position of the support pin or specific jig, when inspecting the electrical performance of a capacitor after mounting on the printed circuit board.

1-1. Avoid bending printed circuit board by the pressure of a test pin, etc.

The thrusting force of the test probe can flex the PCB, resulting in cracked chips or open solder joints. Provide support pins on the back side of the PCB to prevent warping or flexing.

1-2. Avoid vibration of the board by shock when a test pin contacts a printed circuit board.

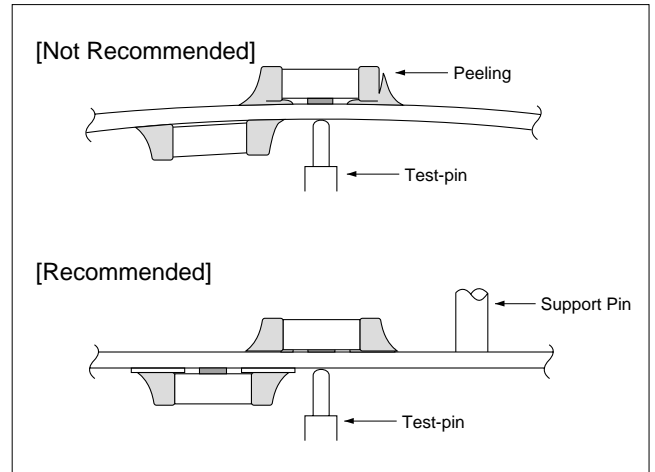

7. Printed Circuit Board Cropping

1. After mounting a capacitor on a printed circuit board, do not apply any stress to the capacitor that is caused by bending or twisting the board.

1-1. In cropping the board, the stress as shown right may cause the capacitor to crack.

Try not to apply this type of stress to a capacitor.

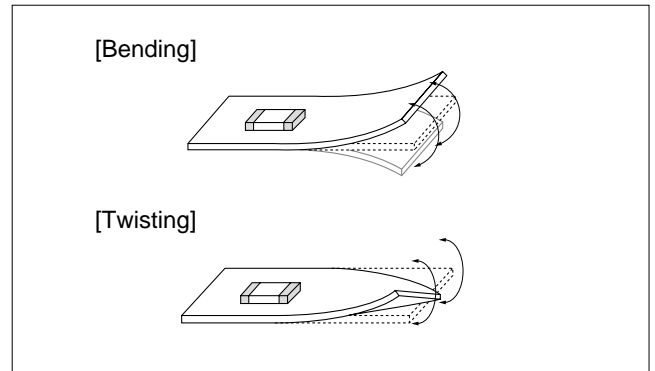

2. Ascertain of the cropping method for the printed circuit board in advance.

2-1. Printed circuit board cropping shall be carried out by using a jig or an apparatus to prevent the mechanical stress that can occur to the board.

(1) Example of a suitable jig

Recommended example: the board should be pushed as close to the cropping jig as possible and from the back side of board in order to minimize the compressive stress applied to capacitor.

Not recommended example: when the board is pushed at a point far from the cropping jig and from the front side of board as below, the capacitor may form a crack caused by the tensile stress applied to capacitor.

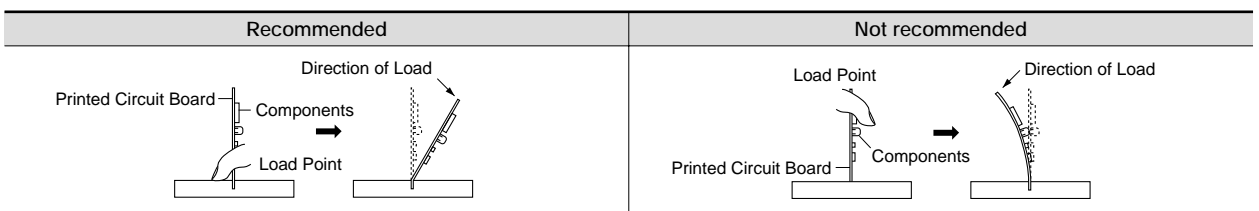
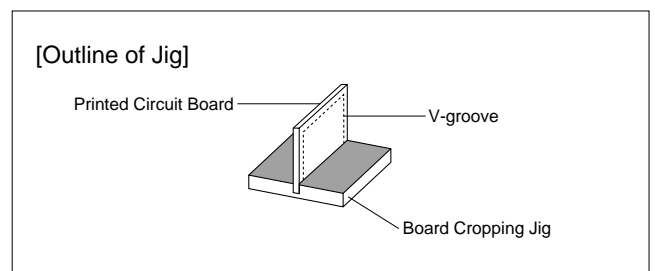

Continued on the following page. ☐

For General GRM Series

Array GNM Series

Low ESL LL□ Series

High-Q GJM Series

High Frequency GOM Series

Monolithic Microchip GMA Series

For Bonding GMD Series

Product Information
△Caution

Caution

Continued from the preceding page.

(2) Example of a suitable machine

An outline of a printed circuit board cropping machine is shown as follows. Along the lines with the V-grooves on the printed circuit board, the top and bottom blades are aligned to one another when cropping the board.

The misalignment of the position between top and bottom blades may cause the capacitor to crack.

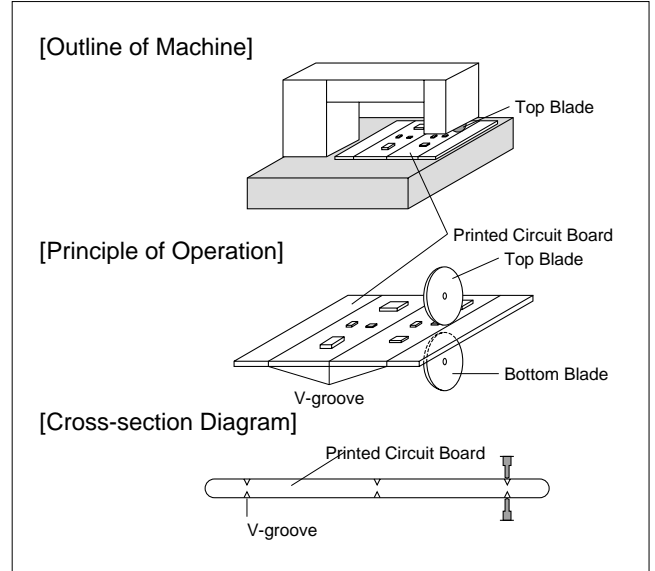

| Recommended | Not Recommended | | |
|--------------------------------------|--------------------------------------|--------------------------------------|--------------------------------------|
| | Top-bottom Misalignment | Left-right Misalignment | Front-rear Misalignment |
| <p>Top Blade</p> <p>Bottom Blade</p> | <p>Top Blade</p> <p>Bottom Blade</p> | <p>Top Blade</p> <p>Bottom Blade</p> | <p>Top Blade</p> <p>Bottom Blade</p> |

For General GRM Series

Array GNM Series

Low ESL LL□ Series

High-Q GJM Series

High Frequency GOM Series

Monolithic Microchip GMA Series

For Bonding GMD Series

Product Information
△Caution



■ Others

1. Under Operation of Equipment

- 1-1. Do not touch a capacitor directly with bare hands during operation in order to avoid the danger of an electric shock.
- 1-2. Do not allow the terminals of a capacitor to come in contact with any conductive objects (short-circuit). Do not expose a capacitor to a conductive liquid, including any acid or alkali solutions.
- 1-3. Confirm the environment in which the equipment will operate is under the specified conditions. Do not use the equipment under the following environments.
 - (1) Being splattered with water or oil.
 - (2) Being exposed to direct sunlight.
 - (3) Being exposed to Ozone, ultraviolet rays or radiation.
 - (4) Being exposed to toxic gas (e.g., hydrogen sulfide, sulfur dioxide, chlorine, ammonia gas, etc.)
 - (5) Any vibrations or mechanical shocks exceeding the specified limits.
 - (6) Moisture condensing environments.
- 1-4. Use damp proof countermeasures if using under any conditions that can cause condensation.

2. Others

- 2-1. In an Emergency
 - (1) If the equipment should generate smoke, fire or smell, immediately turn off or unplug the equipment.

If the equipment is not turned off or unplugged, the hazards may be worsened by supplying continuous power.

- (2) In this type of situation, do not allow face and hands to come in contact with the capacitor or burns may be caused by the capacitor's high temperature.

2-2. Disposal of Waste

When capacitors are disposed, they must be burned or buried by an industrial waste vendor with the appropriate licenses.

2-3. Circuit Design

GRM, GCM, GMA/D, LLL/A/M, GQM, GJM, GNM Series capacitors in this catalog are not safety certified products.

2-4. Remarks

Failure to follow the cautions may result, worst case, in a short circuit and smoking when the product is used.

The above notices are for standard applications and conditions. Contact us when the products are used in special mounting conditions.

Select optimum conditions for operation as they determine the reliability of the product after assembly. The data herein are given in typical values, not guaranteed ratings.

For General
GRM Series

Array
GNM Series

Low ESL
LL□ Series

High-Q
GJM Series

High Frequency
GOM Series

Monolithic Microchip
GMA Series

For Bonding
GMD Series

Product Information
△Caution

Notice

■ Rating

1. Operating Temperature

1. The operating temperature limit depends on the capacitor.

- 1-1. Do not apply temperatures exceeding the upper operating temperature.

It is necessary to select a capacitor with a suitable rated temperature that will cover the operating temperature range.

Also it is necessary to consider the temperature distribution in equipment and the seasonal temperature variable factor.

- 1-2. Consider the self-heating of the capacitor.

The surface temperature of the capacitor shall be the upper operating temperature or less when including the self-heating factors.

2. Atmosphere Surroundings (gaseous and liquid)

1. Restriction on the operating environment of capacitors.

- 1-1. Capacitors, when used in the above, unsuitable, operating environments may deteriorate due to the corrosion of the terminations and the penetration of moisture into the capacitor.

- 1-2. The same phenomenon as the above may occur when the electrodes or terminals of the capacitor are subject to moisture condensation.

- 1-3. The deterioration of characteristics and insulation resistance due to the oxidization or corrosion of terminal electrodes may result in breakdown when the capacitor is exposed to corrosive or volatile gases or solvents for long periods of time.

3. Piezo-electric Phenomenon

1. When using high dielectric constant type capacitors in AC or pulse circuits, the capacitor itself vibrates at specific frequencies and noise may be generated. Moreover, when the mechanical vibration or shock is added to the capacitor, noise may occur.

Notice



■ Soldering and Mounting

1. PCB Design

1. Notice for Pattern Forms

- 1-1. Unlike leaded components, chip components are susceptible to flexing stresses since they are mounted directly on the substrate. They are also more sensitive to mechanical and thermal stresses than leaded components. Excess solder fillet height can multiply these stresses and cause chip cracking. When designing substrates, take land patterns and dimensions into consideration to eliminate the possibility of excess solder fillet height.
- 1-2. It is possible for the chip to crack by the expansion and shrinkage of a metal board. Please contact us if you want to use our ceramic capacitors on a metal board such as Aluminum.

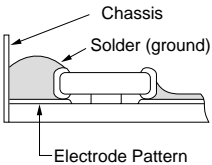
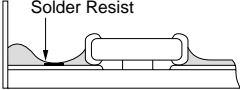
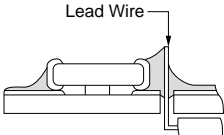
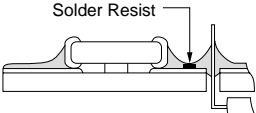
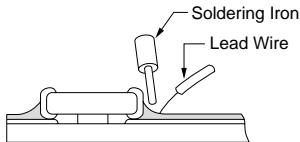
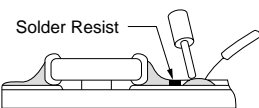
Pattern Forms

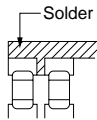
| | Prohibited | Correct |
|---|---|---|
| Placing Close to Chassis |  |  |
| Placing of Chip Components and Leaded Components |  |  |
| Placing of Leaded Components after Chip Component |  |  |
| Lateral Mounting |  |  |

Continued on the following page. 

For General GRM Series

Array GNM Series

Low ESL LL□ Series

High-Q GJM Series

High Frequency GOM Series

Monolithic Microchip GMA Series

For Bonding GMD Series

Product Information Notice

Notice

☐ Continued from the preceding page.

2. Land Dimensions

2-1. A chip capacitor can be cracked due to the stress of PCB bending / etc if the land area is larger than needed and has an excess amount of solder. Please refer to the land dimensions in table 1 for flow soldering, table 2 for reflow soldering, table 3 for GNM & LLA, and table 4 for LLM. Please confirm the suitable land dimension by evaluating the actual SET / PCB.

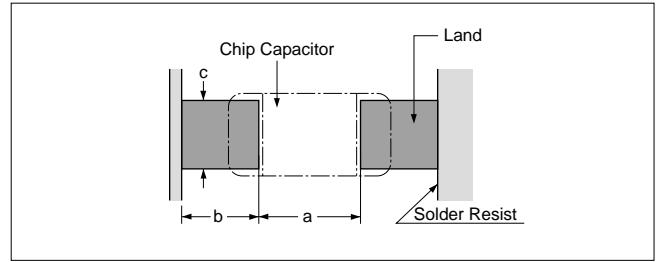

Table 1 Flow Soldering Method

| Part Number | Dimensions | Chip (L×W) | a | b | c |
|------------------------------|------------|------------|------------|------------|------------|
| GRM18 GQM18 | | 1.6×0.8 | 0.6 to 1.0 | 0.8 to 0.9 | 0.6 to 0.8 |
| GRM21 GQM21 | | 2.0×1.25 | 1.0 to 1.2 | 0.9 to 1.0 | 0.8 to 1.1 |
| GRM31 | | 3.2×1.6 | 2.2 to 2.6 | 1.0 to 1.1 | 1.0 to 1.4 |
| LLL21 | | 1.25×2.0 | 0.4 to 0.7 | 0.5 to 0.7 | 1.4 to 1.8 |
| LLL31 | | 1.6×3.2 | 0.6 to 1.0 | 0.8 to 0.9 | 2.6 to 2.8 |

(in mm)

Table 2 Reflow Soldering Method

| Part Number | Dimensions | Chip (L×W) | a | b | c |
|------------------------------|------------|------------|-------------|--------------|-------------|
| GRM02 | | 0.4×0.2 | 0.16 to 0.2 | 0.12 to 0.18 | 0.2 to 0.23 |
| GRM03 GJM03 | | 0.6×0.3 | 0.2 to 0.3 | 0.2 to 0.35 | 0.2 to 0.4 |
| GRM15 GJM15 | | 1.0×0.5 | 0.3 to 0.5 | 0.35 to 0.45 | 0.4 to 0.6 |
| GRM18 GQM18 | | 1.6×0.8 | 0.6 to 0.8 | 0.6 to 0.7 | 0.6 to 0.8 |
| GRM21 GQM21 | | 2.0×1.25 | 1.0 to 1.2 | 0.6 to 0.7 | 0.8 to 1.1 |
| GRM31 | | 3.2×1.6 | 2.2 to 2.4 | 0.8 to 0.9 | 1.0 to 1.4 |
| GRM32 | | 3.2×2.5 | 2.0 to 2.4 | 1.0 to 1.2 | 1.8 to 2.3 |
| GRM43 | | 4.5×3.2 | 3.0 to 3.5 | 1.2 to 1.4 | 2.3 to 3.0 |
| GRM55 | | 5.7×5.0 | 4.0 to 4.6 | 1.4 to 1.6 | 3.5 to 4.8 |
| LLL15 | | 0.5×1.0 | 0.15 to 0.2 | 0.2 to 0.25 | 0.7 to 1.0 |
| LLL18 LLR18 | | 0.8×1.6 | 0.2 to 0.3 | 0.3 to 0.4 | 1.4 to 1.6 |
| LLL21 | | 1.25×2.0 | 0.4 to 0.6 | 0.4 to 0.5 | 1.4 to 1.8 |
| LLL31 | | 1.6×3.2 | 0.6 to 0.8 | 0.6 to 0.7 | 2.6 to 2.8 |
| GQM22 | | 3.2×2.5 | 2.2 to 2.5 | 0.8 to 1.0 | 1.9 to 2.3 |

(in mm)

Continued on the following page. ☐

Notice

Continued from the preceding page.

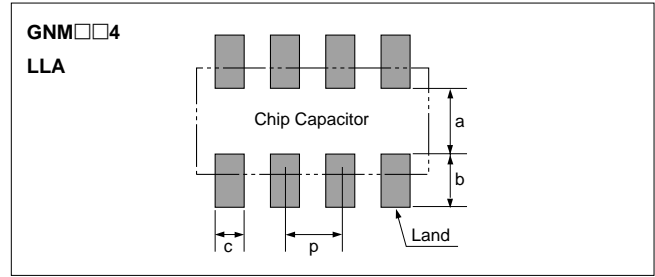
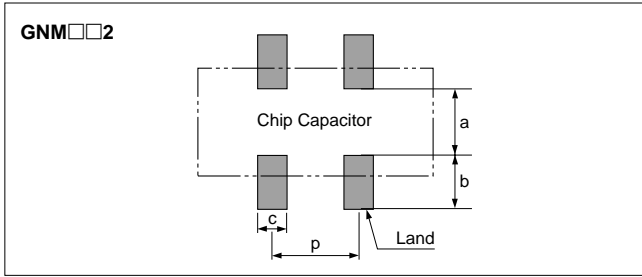

Table 3 GNM, LLA Series for Reflow Soldering Land Dimensions

| Part Number | Dimensions (mm) | | | | | |
|---------------|-----------------|------|---------------|---------------|--------------|------|
| | L | W | a | b | c | p |
| GNM0M2 | 0.9 | 0.6 | 0.12 to 0.20* | 0.35 to 0.40* | 0.3 | 0.45 |
| GNM1M2 | 1.37 | 1.0 | 0.4 to 0.5 | 0.35 to 0.45 | 0.3 to 0.35 | 0.64 |
| GNM212 | 2.0 | 1.25 | 0.6 to 0.7 | 0.5 to 0.7 | 0.4 to 0.5 | 1.0 |
| GNM214 | 2.0 | 1.25 | 0.6 to 0.7 | 0.5 to 0.7 | 0.25 to 0.35 | 0.5 |
| GNM314 | 3.2 | 1.6 | 0.8 to 1.0 | 0.7 to 0.9 | 0.3 to 0.4 | 0.8 |
| LLA18 | 1.6 | 0.8 | 0.3 to 0.4 | 0.25 to 0.35 | 0.15 to 0.25 | 0.4 |
| LLA21 | 2.0 | 1.25 | 0.5 to 0.7 | 0.35 to 0.6 | 0.2 to 0.3 | 0.5 |
| LLA31 | 3.2 | 1.6 | 0.7 to 0.9 | 0.4 to 0.7 | 0.3 to 0.4 | 0.8 |

* $0.82 \leq a+2b \leq 1.00$

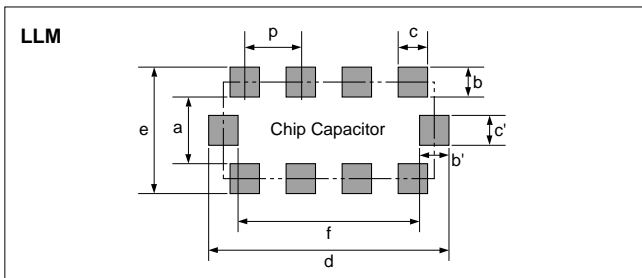

Table 4 LLM Series for Reflow Soldering Land Dimensions

| Part Number | Dimensions (mm) | | | | | | |
|--------------|-----------------|--------------|-------|------------|------------|------------|-----|
| | a | b, b' | c, c' | d | e | f | p |
| LLM21 | 0.6 to 0.8 | (0.3 to 0.5) | 0.3 | 2.0 to 2.6 | 1.3 to 1.8 | 1.4 to 1.6 | 0.5 |
| LLM31 | 1.0 | (0.3 to 0.5) | 0.4 | 3.2 to 3.6 | 1.6 to 2.0 | 2.6 | 0.8 |

$b=(c-e)/2, b'=(d-f)/2$

2. Adhesive Application

- Thin or insufficient adhesive can cause the chips to loosen or become disconnected during flow soldering. The amount of adhesive must be more than dimension c, shown in the drawing at right, to obtain the correct bonding strength. The chip's electrode thickness and land thickness must also be taken into consideration.
- Low viscosity adhesive can cause chips to slip after mounting. The adhesive must have a viscosity of 5000Pa · s (500ps) min. (at 25°C).

3. Adhesive Coverage

| Part Number | Adhesive Coverage* |
|----------------------------|--------------------|
| GRM18, GQM18 | 0.05mg min. |
| GRM21, LLL21, GQM21 | 0.1mg min. |
| GRM31, LLL31 | 0.15mg min. |

*Nominal Value

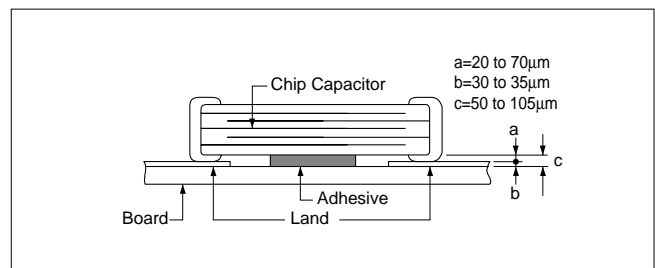

Continued on the following page.

Notice

☐ Continued from the preceding page.

3. Adhesive Curing

1. Insufficient curing of the adhesive can cause chips to disconnect during flow soldering and deterioration in the insulation resistance between the outer electrodes due to moisture absorption.

Control curing temperature and time in order to prevent insufficient hardening.

4. Flux Application

1. An excessive amount of flux generates a large quantity of flux gas, which can cause a deterioration of Solderability. Therefore apply flux thinly and evenly throughout. (A foaming system is generally used for flow soldering.)
2. Flux containing too high a percentage of halide may cause corrosion of the outer electrodes unless there is sufficient cleaning. Use flux with a halide content of 0.2% max.

3. Do not use strong acidic flux.

4. Do not use water-soluble *flux.

(*Water-soluble flux can be defined as non rosin type flux including wash-type flux and non-wash-type flux.)

5. Flow Soldering

- Set temperature and time to ensure that leaching of the outer electrode does not exceed 25% of the chip end area as a single chip (full length of the edge A-B-C-D shown right) and 25% of the length A-B shown below as mounted on substrate.

[As a Single Chip]

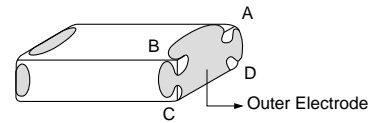

[As Mounted on Substrate]

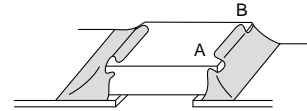

6. Washing

1. Please evaluate a capacitor by actual cleaning equipment and conditions to confirm the quality and select the applicable solvent.
2. Unsuitable cleaning solvent may leave residual flux or other foreign substances, causing deterioration of electrical characteristics and the reliability of the

capacitors.

3. Select the proper cleaning conditions.

- 3-1. Improper cleaning conditions (excessive or insufficient) may result in the deterioration of the performance of the capacitors.

Continued on the following page. ☐

Notice

☐ Continued from the preceding page.

7. Coating

1. A crack may be caused in the capacitor due to the stress of the thermal contraction of the resin during curing process.

The stress is affected by the amount of resin and curing contraction.

Select a resin with small curing contraction.

The difference in the thermal expansion coefficient between a coating resin or a molding resin and the capacitor may cause the destruction and deterioration of the capacitor such as a crack or peeling, and lead to the deterioration of insulation resistance or dielectric breakdown.

Select a resin for which the thermal expansion coefficient is as close to that of capacitor as possible.

A silicone resin can be used as an under-coating to buffer against the stress.

2. Select a resin that is less hygroscopic.

Using hygroscopic resins under high humidity conditions may cause the deterioration of the insulation resistance of a capacitor.

An epoxy resin can be used as a less hygroscopic resin.

8. Die Bonding/Wire Bonding (GMA or GMD Series)

1. Die Bonding of Capacitors

- Use the following materials for the Brazing alloys:
Au-Sn (80/20) 300 to 320 °C in N₂ atmosphere

- Mounting

- (1) Control the temperature of the substrate so it matches the temperature of the brazing alloy.
- (2) Place the brazing alloy on the substrate and place the capacitor on the alloy. Hold the capacitor and gently apply the load. Be sure to complete the operation within 1 minute.

2. Wire Bonding

- Wire

Gold wire: 25 micro m (0.001 inch) diameter

- Bonding

- (1) Thermo compression, ultrasonic ball bonding.
- (2) Required stage temperature: 150 to 200 °C
- (3) Required wedge or capillary weight: 0.2N to 0.5N
- (4) Bond the capacitor and base substrate or other devices with gold wire.

For General
GRM Series

Array
GNM Series

Low ESL
LL□ Series

High-Q
GJM Series

High Frequency
GOM Series

Monolithic Microchip
GMA Series

For Bonding
GMD Series

Product Information
Notice

Notice

■ Others

1. Transportation

1. The performance of a capacitor may be affected by the conditions during transportation.

1-1. The capacitors shall be protected against excessive temperature, humidity and mechanical force during transportation.

(1) Climatic condition

- low air temperature: -40°C
- change of temperature air/air: -25°C/+25°C
- low air pressure: 30 kPa
- change of air pressure: 6 kPa/min.

(2) Mechanical condition

Transportation shall be done in such a way that the boxes are not deformed and forces are not directly passed on to the inner packaging.

1-2. Do not apply excessive vibration, shock, and pressure to the capacitor.

- (1) When excessive mechanical shock or pressure is applied to a capacitor, chipping or cracking may occur in the ceramic body of the capacitor.
- (2) When the sharp edge of an air driver, a soldering iron, tweezers, a chassis, etc. impacts strongly on the surface of capacitor, the capacitor may crack and short-circuit.

1-3. Do not use a capacitor to which excessive shock was applied by dropping, etc.

The capacitor dropped accidentally during processing may be damaged.

Reference Data

1. Solderability

(1) Test Method

Subject the chip capacitor to the following conditions.
 Then apply flux (an ethanol solution of 25% rosin) to the chip and dip it in 230°C eutectic solder for 2 seconds.

Conditions:

Expose prepared at room temperature (for 6 months and 12 months, respectively)

Prepared at high temperature (for 100 hours at 85°C)

Prepared left at high humidity (for 100 hours under 90%RH to 95%RH at 40°C)

(2) Test Samples

GRM21 : Products for flow/reflow soldering.

(3) Acceptance Criteria

With a 60-power optical microscope, measure the surface area of the outer electrode that is covered with solder.

(4) Results

Refer to Table 1.

Table 1

| Sample | Initial State | Prepared at Room Temperature | | Prepared at High Temperature for 100 Hours at 85°C | Prepared at High Humidity for 100 Hours at 90 to 95% RH and 40°C |
|---------------------------------|---------------|------------------------------|-----------|--|--|
| | | 6 months | 12 months | | |
| GRM21 for flow/reflow soldering | 95 to 100% | 95 to 100% | 95% | 90 to 95% | 95% |

2. Board Bending Strength for Solder Fillet Height

(1) Test Method

Solder the chip capacitor to the test PCB with the amount of solder paste necessary to achieve the fillet heights.

Then bend the PCB using the method illustrated and measure capacitance.

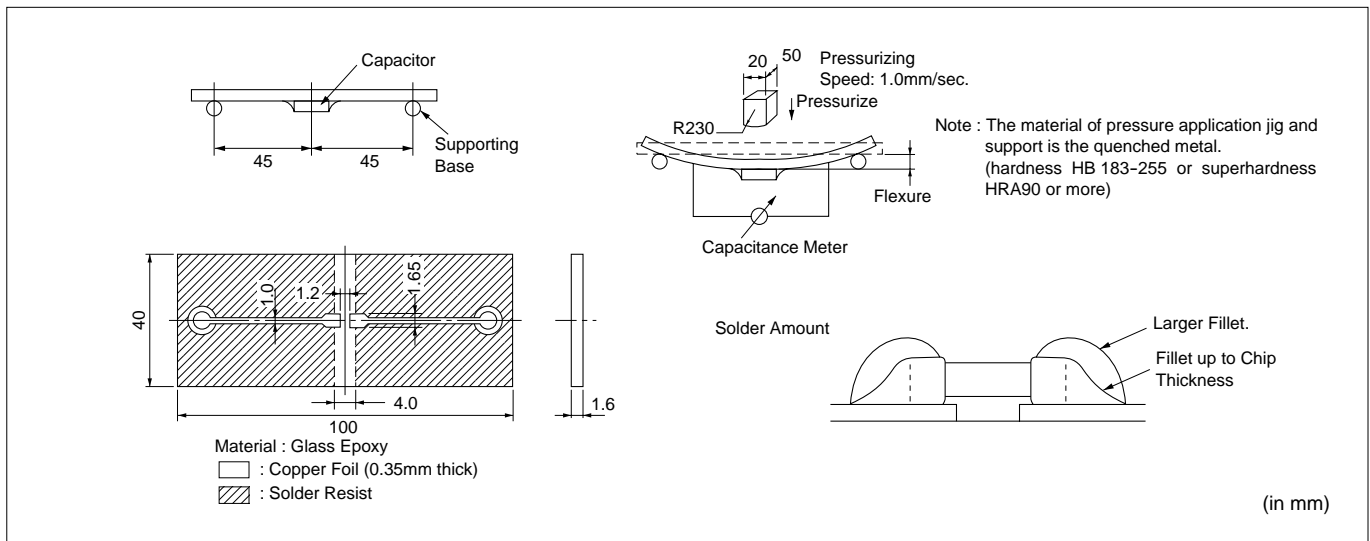

(2) Test Samples

GRM21: 5C/R7/F5 Characteristics T=0.6mm

(3) Acceptance Criteria

Products should be determined to be defective if the change in capacitance has exceeded the values specified in Table 2.

Table 2

| Characteristics | Change in Capacitance |
|-----------------|---|
| 5C | Within $\pm 5\%$ or $\pm 0.5\text{pF}$, whichever is greater |
| R7 | Within $\pm 12.5\%$ |
| F5 | Within $\pm 20\%$ |

Continued on the following page.

Reference Data

☐ Continued from the preceding page.

(4) Results

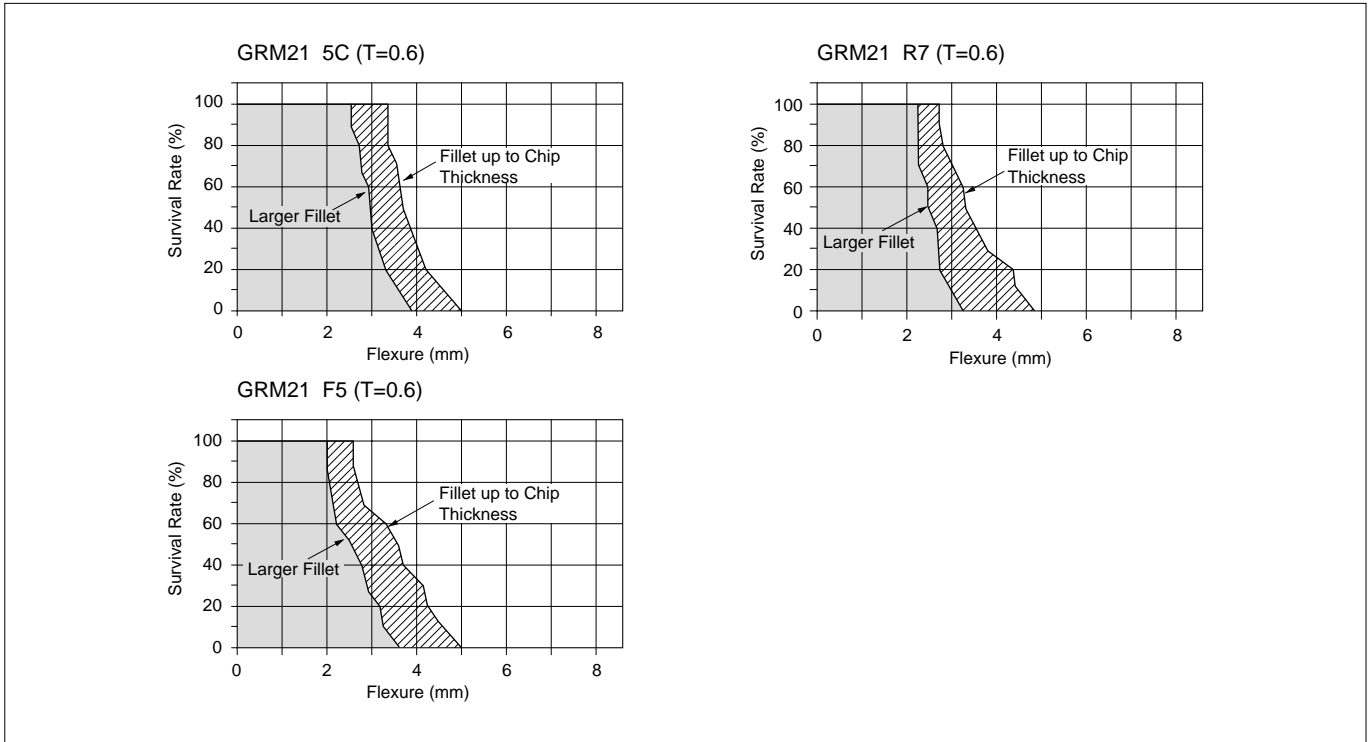

3. Temperature Cycling for Solder Fillet Height

(1) Test Method

Solder the chips to the substrate of various test fixtures using sufficient amounts of solder to achieve the required fillet height. Then subject the fixtures to the cycle illustrated at right 200 times.

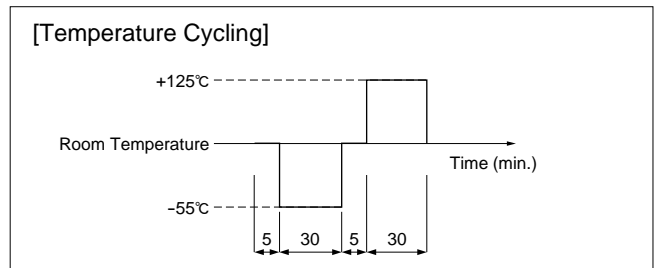

① Solder Amount

Alumina substrates are typically designed for reflow soldering.

Glass epoxy or paper phenol substrates are typically used for flow soldering.

② Material

- Alumina (Thickness: 0.64mm)
- Glass epoxy (Thickness: 1.64mm)
- Paper phenol (Thickness: 1.64mm)

[Solder Amount]

| Substrate | | Alumina | Glass Epoxy or Paper Phenol |
|-------------------|---|---------------------|-----------------------------|
| Solder Amount | ① | | |
| | ② | | |
| | ③ | | |
| Solder to be used | | 6X4 Eutectic solder | |

③ Land Dimension

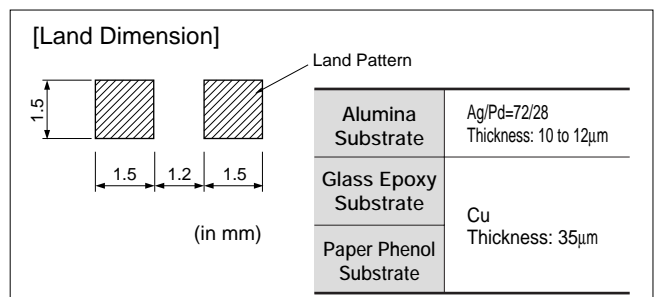

Continued on the following page. ↗

Reference Data

Continued from the preceding page.

(2) Test Samples

GRM21 5C/R7/F5 Characteristics T=0.6mm

(3) Acceptance Criteria

Products are determined to be defective if the change in capacitance has exceeded the values specified in Table 3.

Table 3

| Characteristics | Change in Capacitance |
|-----------------|--|
| 5C | Within $\pm 2.5\%$ or $\pm 0.25\text{pF}$, whichever is greater |
| R7 | Within $\pm 7.5\%$ |
| F5 | Within $\pm 20\%$ |

(4) Results

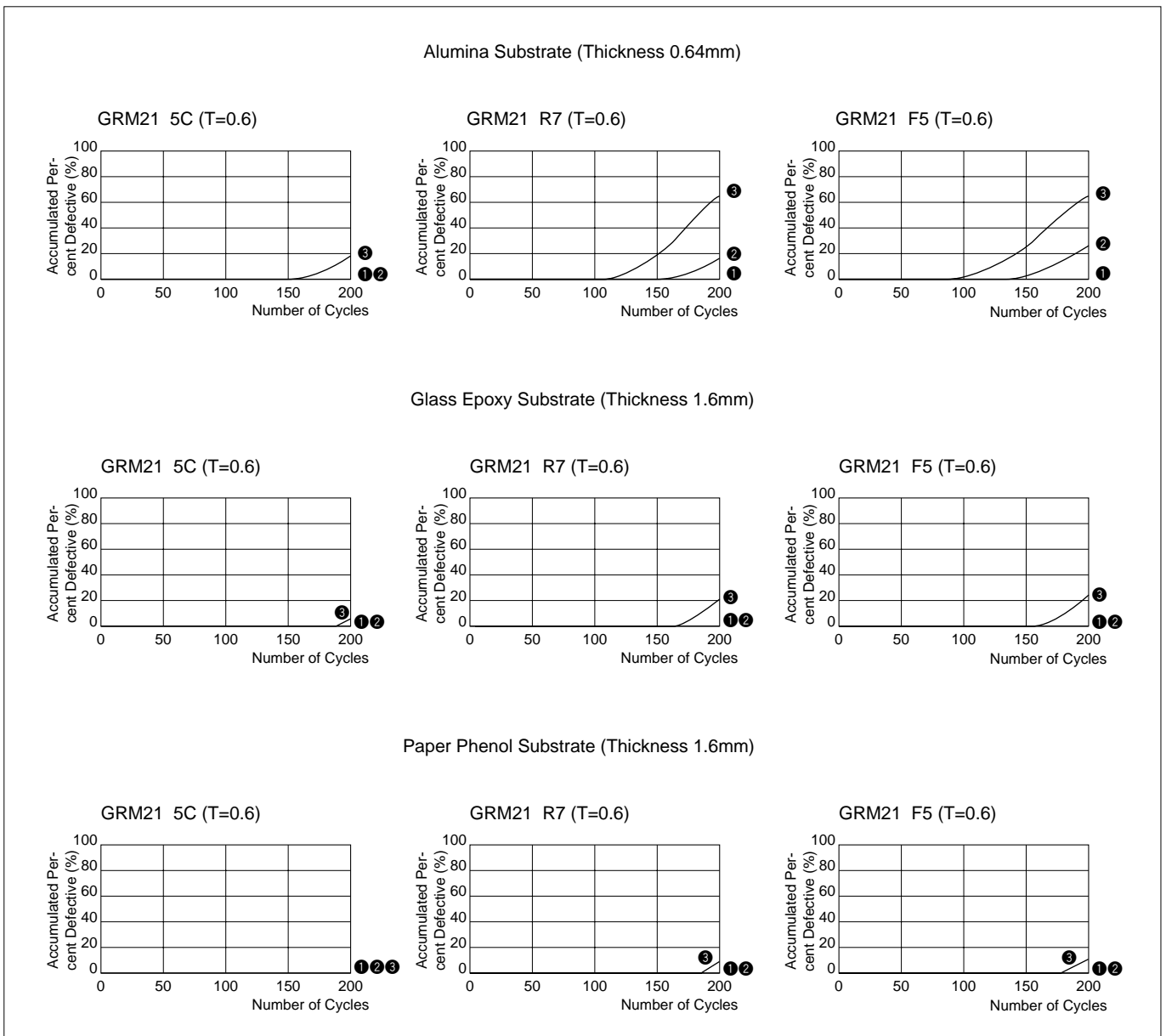

Continued on the following page.

For General
GRM Series

Array
GMM Series

Low ESL
LL□ Series

High-Q
GJM Series

High Frequency
GOM Series

Monolithic Microchip
GMA Series

For Bonding
GMD Series

Product Information
Reference Data

Reference Data

☐ Continued from the preceding page.

4. Board Bending Strength for Board Material

(1) Test Method

Solder the chip to the test board. Then bend the board using the method illustrated below, to measure capacitance.

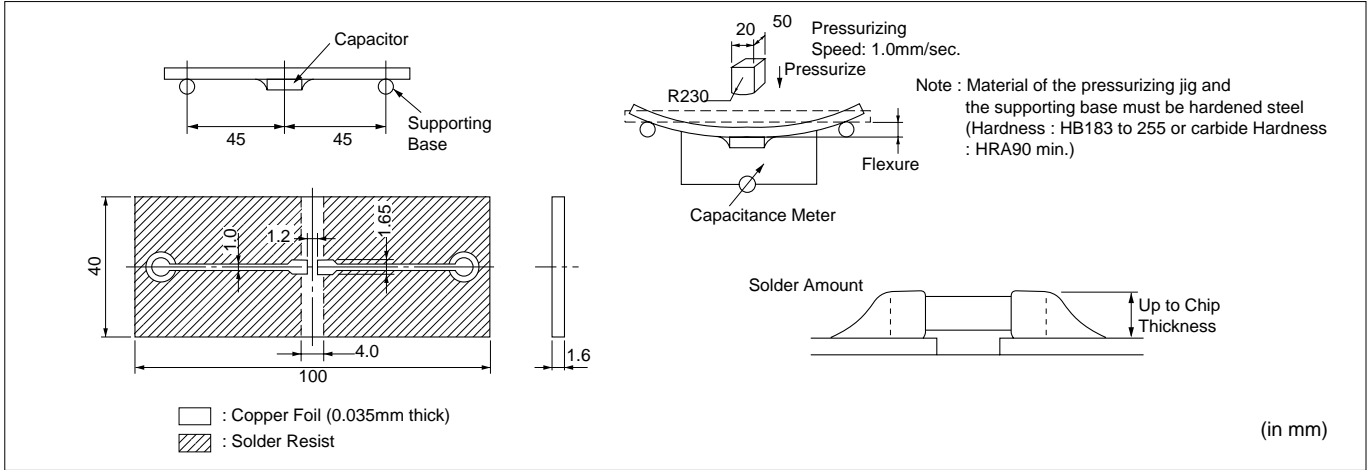

(2) Test Samples

GRM21 5C/R7/F5 Characteristics T=0.6mm typical

(3) Acceptance Criteria

Products should be determined to be defective if the change in capacitance has exceeded the values specified in Table 4.

Table 4

| Characteristics | Change in Capacitance |
|-----------------|---|
| 5C | Within $\pm 5\%$ or $\pm 0.5\text{pF}$, whichever is greater |
| R7 | Within $\pm 12.5\%$ |
| F5 | Within $\pm 20\%$ |

(4) Results

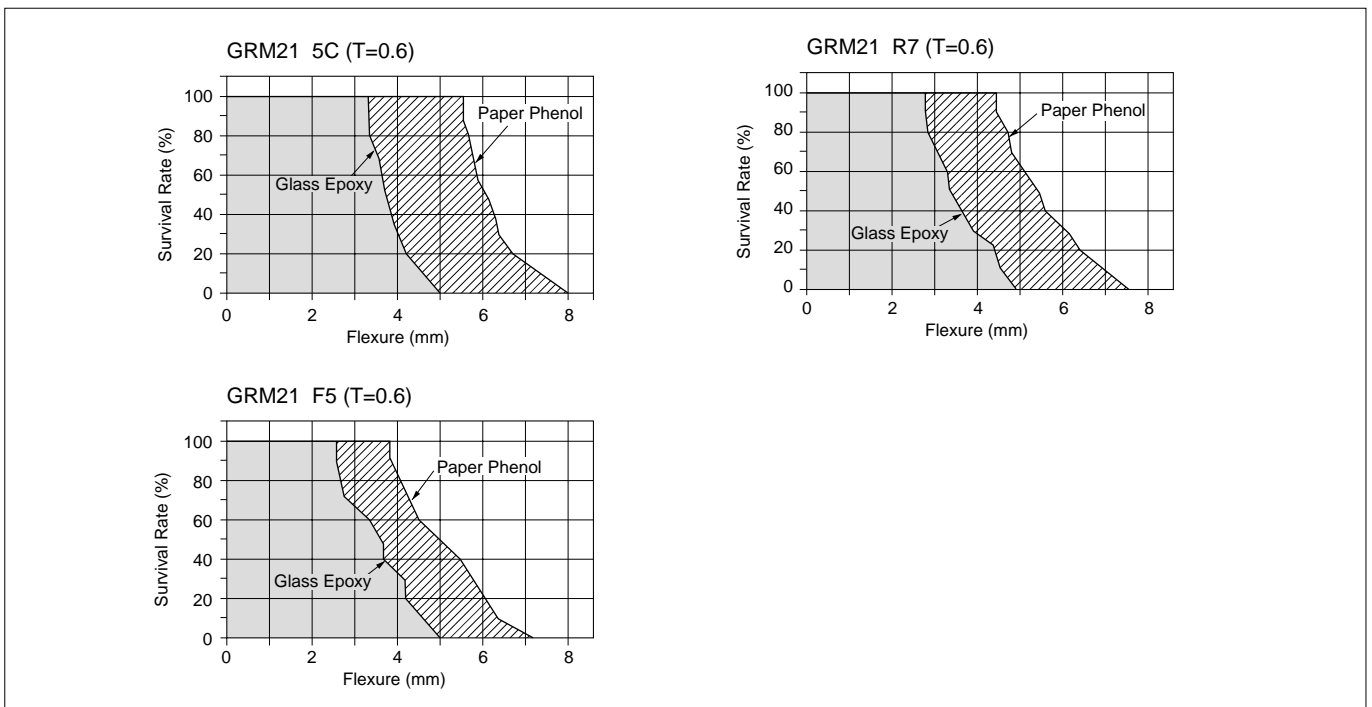

Continued on the following page. ↗

Reference Data

☐ Continued from the preceding page.

5. Break Strength

(1) Test Method

Place the chip on a steel plate as illustrated on the right. Increase load applied to a point near the center of the test sample.

(2) Test Samples

GRM21 5C/R7/F5 Characteristics
GRM31 5C/R7/F5 Characteristics

(3) Acceptance Criteria

Define the load that has caused the chip to break or crack, as the bending force.

(4) Explanation

Break strength, P, is proportionate to the square of the thickness of the ceramic element and is expressed as a curve of secondary degree.

The formula is:

$$P = \frac{2\gamma WT^2}{3L} \quad (\text{N})$$

- W : Width of ceramic element (mm)
- T : Thickness of element (mm)
- L : Distance between fulcrums (mm)
- γ : Bending stress (N/mm²)

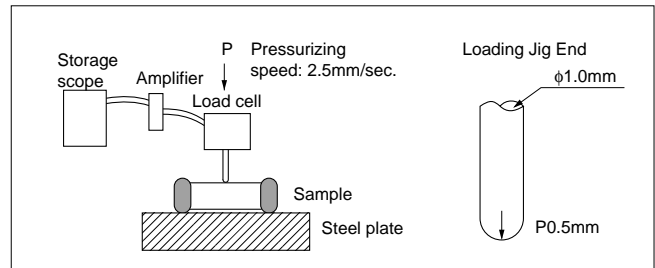

| Chip Size | L | W | γ | | |
|--------------|-----|-----|--------------------|--------------------|--------------------|
| | | | 5C Characteristics | R7 Characteristics | F5 Characteristics |
| GRM21 | 1.5 | 1.2 | 300 | 180 | 160 |
| GRM31 | 2.7 | 1.5 | | | |

(in mm)

(5) Results

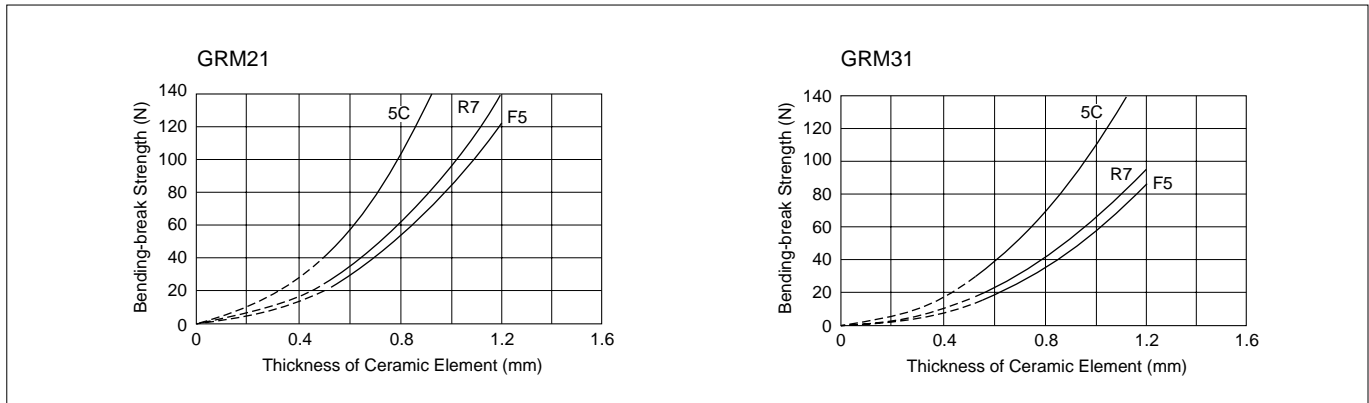

6. Thermal Shock

(1) Test method

After applying flux (an ethanol solution of 25% rosin), dip the chip in a solder bath (6X4 eutectic solder) in accordance with the following conditions:

(2) Test samples

GRM21 5C/R7/F5 Characteristics T=0.6mm typical

(3) Acceptance criteria

Visually inspect the test sample with a 60-power optical microscope. Chips exhibiting breaks or cracks should be determined to be defective.

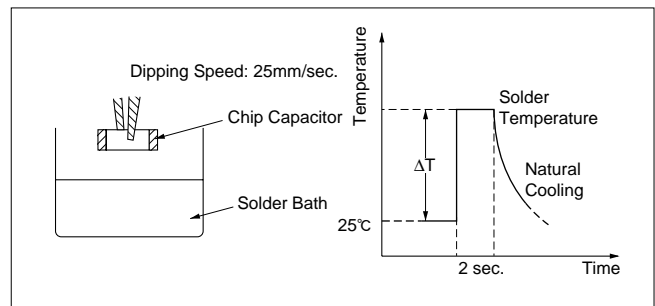

Continued on the following page. ☐

Reference Data

Continued from the preceding page.

(4) Results

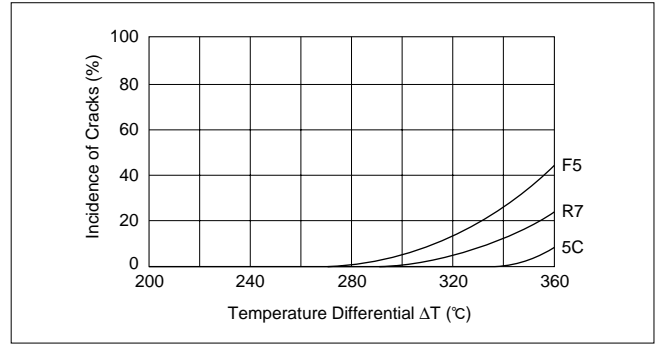

7. Solder Heat Resistance

(1) Test Method

① Reflow soldering:

Apply about 300 μm of solder paste over the alumina substrate. After reflow soldering, remove the chip and check for leaching that may have occurred on the outer electrode.

② Flow soldering:

After dipping the test sample with a pair of tweezers in wave solder (eutectic solder), check for leaching that may have occurred on the outer electrode.

③ Dip soldering:

After dipping the test sample with a pair of tweezers in static solder (eutectic solder), check for leaching that may have occurred on the outer electrode.

④ Flux to be used: An ethanol solution of 25% rosin.

(2) Test samples

GRM21: For flow/reflow soldering T=0.6mm

(3) Acceptance criteria

The starting time of leaching should be defined as the time when the outer electrode has lost 25% of the total edge length of A-B-C-D as illustrated:

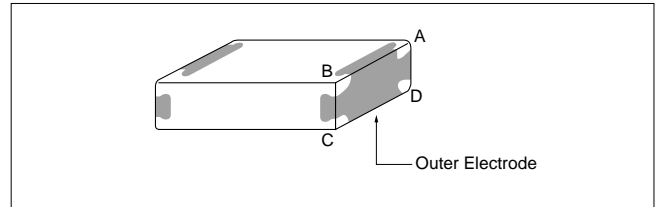

(4) Results

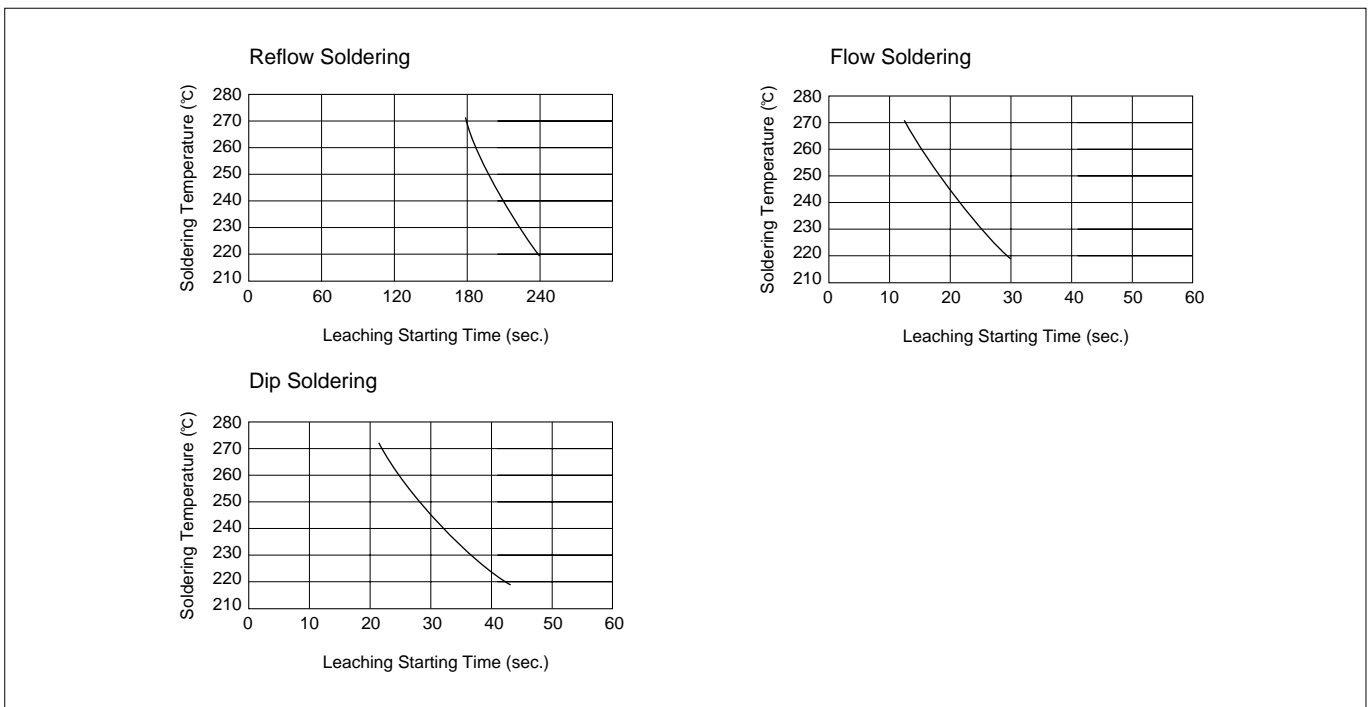

Continued on the following page.

Reference Data

☐ Continued from the preceding page.

8. Thermal Shock when Making Corrections with a Soldering Iron

(1) Test Method

Apply a soldering iron meeting the conditions below to the soldered joint of a chip that has been soldered to a paper phenol board, while supplying wire solder. (Note: the soldering iron tip should not directly touch the ceramic element of the chip.)

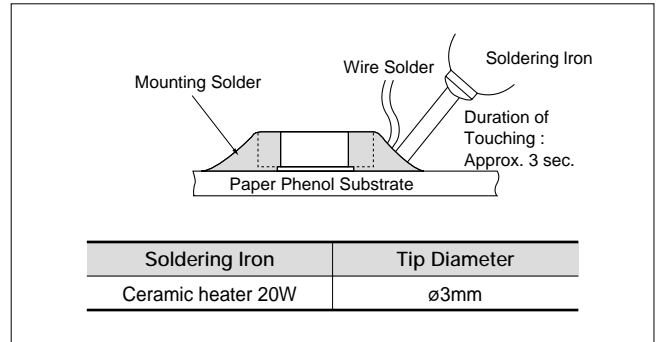

(2) Test Samples

GRM21 5C/R7/F5 Characteristics T=0.6mm

(3) Acceptance Criteria for Defects

Observe the appearance of the test sample with a 60-power optical microscope. Those units displaying any breaks or cracks are determined to be defective.

(4) Results

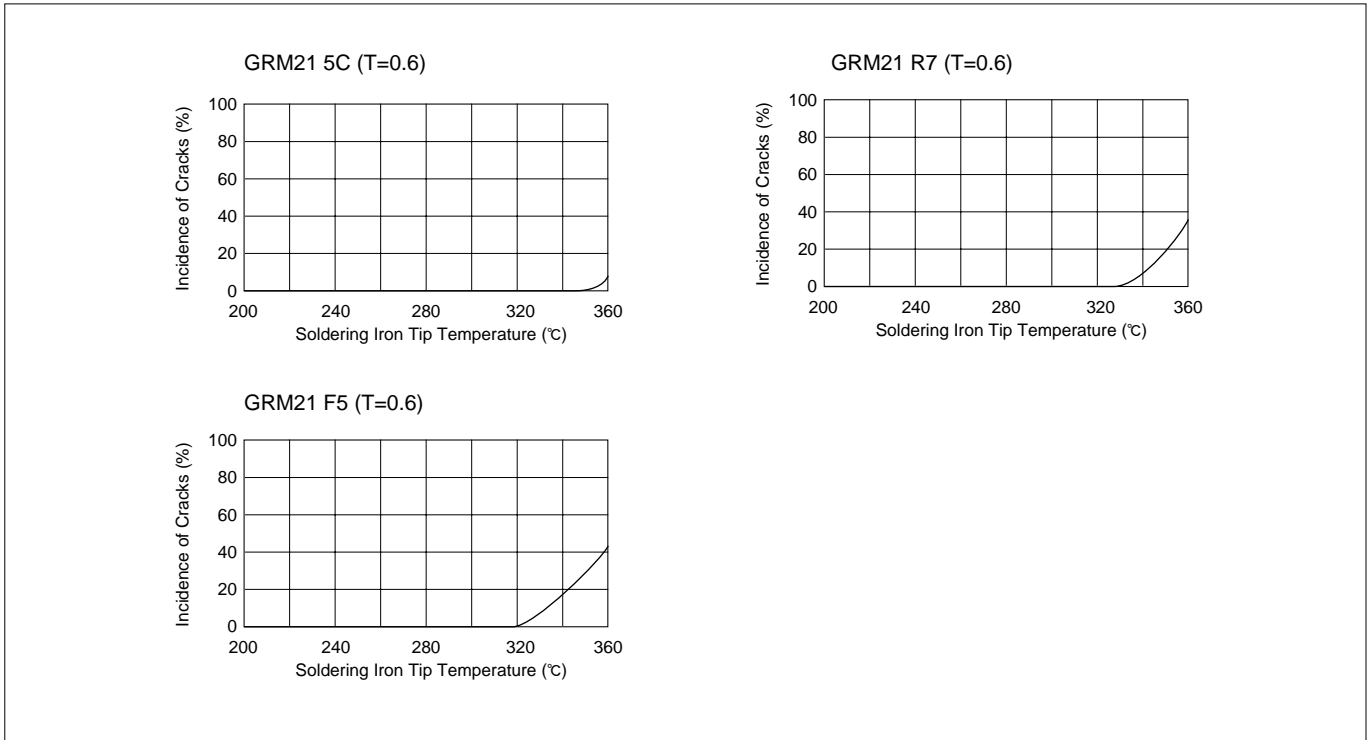

For General GRM Series

Array GNM Series

Low ESL LL□ Series

High-Q GJM Series

High Frequency GOM Series

Monolithic Microchip GMA Series

For Bonding GMD Series

Product Information Reference Data

Chip Monolithic Ceramic Capacitors (Medium Voltage)

| | | |
|----------|---|-----|
| 1 | For General Purpose GRM/GRJ Series | |
| 1-1 | Low Dissipation Factor GRM Series | 160 |
| | Specifications and Test Methods | 164 |
| 1-2 | High Capacitance for General Use GRM Series | 166 |
| | Specifications and Test Methods | 168 |
| 1-3 | Soft Termination Type GRJ Series | 171 |
| | Specifications and Test Methods | 173 |

| | | |
|----------|--|-----|
| 2 | Only for Applications | |
| 2-1 | For LCD Backlight Inverter Circuit GRM/DC3.15kV Series | 176 |
| | Specifications and Test Methods | 177 |
| 2-2 | For Information Devices GR4 Series | 179 |
| | Specifications and Test Methods | 180 |
| 2-3 | For Camera Flash Circuit GR7 Series | 183 |
| | Specifications and Test Methods | 184 |

| | | |
|----------|---|-----|
| 3 | AC250V Type (Which Meet Japanese Law) GA2 Series | 187 |
| | Specifications and Test Methods | 188 |

| | | |
|----------|---|-----|
| 4 | Safety Standard Certified GA3 Series | |
| 4-1 | UL, IEC60384-14 Class X1/Y2 Type GC | 191 |
| 4-2 | IEC60384-14 Class Y2, X1/Y2 Type GF | 192 |
| 4-3 | IEC60384-14 Class Y3 Type GD | 194 |
| 4-4 | IEC60384-14 Class X2 Type GB | 195 |
| | Specifications and Test Methods | 196 |

| | |
|----------------------------------|-----|
| Reference Data (Typical Example) | 200 |
| Package | 203 |
| △Caution | 206 |
| Notice | 214 |

Chip Monolithic Ceramic Capacitors (Medium Voltage)



Low Dissipation Factor GRM Series

■ Features

1. Low-loss and suitable for high frequency circuits
2. Murata's original internal electrode structure provides high flash-over voltage.
3. A new monolithic structure for small, surface-mountable devices capable of operating at high voltage levels
4. Sn-plated external electrodes provides good solderability.
5. Use the GRM21/31 type with flow or reflow soldering, and other types with reflow soldering only.

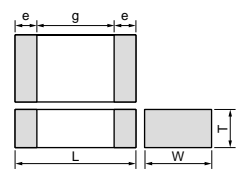

| Part Number | Dimensions (mm) | | | | |
|-------------|-----------------|-----------|---------------|--------|--------|
| | L | W | T | e min. | g min. |
| GRM21A | 2.0 ±0.2 | 1.25 ±0.2 | 1.0 +0, -0.3 | 0.3 | 0.7 |
| GRM21B | | | 1.25 ±0.2 | | |
| GRM31A | 3.2 ±0.2 | 1.6 ±0.2 | 1.0 +0, -0.3 | | 1.5* |
| GRM31B | | | 1.25 +0, -0.3 | | |
| GRM32A | 3.2 ±0.2 | 2.5 ±0.2 | 1.0 +0, -0.3 | | |
| GRM32B | | | 1.25 +0, -0.3 | | |
| GRM42A | 4.5 ±0.3 | 2.0 ±0.2 | 1.0 +0, -0.3 | 2.9 | |

* GRM31A7U3D, GRM32A7U3D, GRM32B7U3D: 1.8mm min.

■ Applications

Ideal for use on high frequency pulse circuits such as snubber circuits for switching power supplies, DC-DC converters, ballasts (inverter fluorescent lamps), etc.

Do not use these products in any Automotive Power train or Safety equipment including Battery chargers for Electric Vehicles and Plug-in Hybrids. Only Murata products clearly stipulated as "for Automotive use" can be used for automobile applications such as Power train and Safety equipment.

C0G Characteristics

| Part Number | Rated Voltage (V) | TC Code (Standard) | Capacitance (pF) | Length L (mm) | Width W (mm) | Thickness T (mm) | Electrode g min. (mm) | Electrode e (mm) |
|--------------------|-------------------|--------------------|------------------|---------------|--------------|------------------|-----------------------|------------------|
| GRM21A5C2E100JW01D | DC250 | C0G (EIA) | 10 ±5% | 2.0 | 1.25 | 1.0 | 0.7 | 0.3 min. |
| GRM21A5C2E120JW01D | DC250 | C0G (EIA) | 12 ±5% | 2.0 | 1.25 | 1.0 | 0.7 | 0.3 min. |
| GRM21A5C2E150JW01D | DC250 | C0G (EIA) | 15 ±5% | 2.0 | 1.25 | 1.0 | 0.7 | 0.3 min. |
| GRM21A5C2E180JW01D | DC250 | C0G (EIA) | 18 ±5% | 2.0 | 1.25 | 1.0 | 0.7 | 0.3 min. |
| GRM21A5C2E220JW01D | DC250 | C0G (EIA) | 22 ±5% | 2.0 | 1.25 | 1.0 | 0.7 | 0.3 min. |
| GRM21A5C2E270JW01D | DC250 | C0G (EIA) | 27 ±5% | 2.0 | 1.25 | 1.0 | 0.7 | 0.3 min. |
| GRM21A5C2E330JW01D | DC250 | C0G (EIA) | 33 ±5% | 2.0 | 1.25 | 1.0 | 0.7 | 0.3 min. |
| GRM21A5C2E390JW01D | DC250 | C0G (EIA) | 39 ±5% | 2.0 | 1.25 | 1.0 | 0.7 | 0.3 min. |
| GRM21A5C2E470JW01D | DC250 | C0G (EIA) | 47 ±5% | 2.0 | 1.25 | 1.0 | 0.7 | 0.3 min. |
| GRM21A5C2E560JW01D | DC250 | C0G (EIA) | 56 ±5% | 2.0 | 1.25 | 1.0 | 0.7 | 0.3 min. |
| GRM21A5C2E680JW01D | DC250 | C0G (EIA) | 68 ±5% | 2.0 | 1.25 | 1.0 | 0.7 | 0.3 min. |
| GRM21A5C2E820JW01D | DC250 | C0G (EIA) | 82 ±5% | 2.0 | 1.25 | 1.0 | 0.7 | 0.3 min. |
| GRM21A5C2E101JW01D | DC250 | C0G (EIA) | 100 ±5% | 2.0 | 1.25 | 1.0 | 0.7 | 0.3 min. |
| GRM31A5C2J100JW01D | DC630 | C0G (EIA) | 10 ±5% | 3.2 | 1.6 | 1.0 | 1.5 | 0.3 min. |
| GRM31A5C2J120JW01D | DC630 | C0G (EIA) | 12 ±5% | 3.2 | 1.6 | 1.0 | 1.5 | 0.3 min. |
| GRM31A5C2J150JW01D | DC630 | C0G (EIA) | 15 ±5% | 3.2 | 1.6 | 1.0 | 1.5 | 0.3 min. |
| GRM31A5C2J180JW01D | DC630 | C0G (EIA) | 18 ±5% | 3.2 | 1.6 | 1.0 | 1.5 | 0.3 min. |
| GRM31A5C2J220JW01D | DC630 | C0G (EIA) | 22 ±5% | 3.2 | 1.6 | 1.0 | 1.5 | 0.3 min. |
| GRM31A5C2J270JW01D | DC630 | C0G (EIA) | 27 ±5% | 3.2 | 1.6 | 1.0 | 1.5 | 0.3 min. |
| GRM31A5C2J330JW01D | DC630 | C0G (EIA) | 33 ±5% | 3.2 | 1.6 | 1.0 | 1.5 | 0.3 min. |
| GRM31A5C2J390JW01D | DC630 | C0G (EIA) | 39 ±5% | 3.2 | 1.6 | 1.0 | 1.5 | 0.3 min. |
| GRM31A5C2J470JW01D | DC630 | C0G (EIA) | 47 ±5% | 3.2 | 1.6 | 1.0 | 1.5 | 0.3 min. |
| GRM31A5C2J560JW01D | DC630 | C0G (EIA) | 56 ±5% | 3.2 | 1.6 | 1.0 | 1.5 | 0.3 min. |

Continued on the following page.



Continued from the preceding page.

| Part Number | Rated Voltage (V) | TC Code (Standard) | Capacitance (pF) | Length L (mm) | Width W (mm) | Thickness T (mm) | Electrode g min. (mm) | Electrode e (mm) |
|--------------------|-------------------|--------------------|------------------|---------------|--------------|------------------|-----------------------|------------------|
| GRM31A5C2J680JW01D | DC630 | C0G (EIA) | 68 ±5% | 3.2 | 1.6 | 1.0 | 1.5 | 0.3 min. |
| GRM31A5C2J820JW01D | DC630 | C0G (EIA) | 82 ±5% | 3.2 | 1.6 | 1.0 | 1.5 | 0.3 min. |
| GRM31A5C2J101JW01D | DC630 | C0G (EIA) | 100 ±5% | 3.2 | 1.6 | 1.0 | 1.5 | 0.3 min. |
| GRM31A5C2J121JW01D | DC630 | C0G (EIA) | 120 ±5% | 3.2 | 1.6 | 1.0 | 1.5 | 0.3 min. |
| GRM31A5C2J151JW01D | DC630 | C0G (EIA) | 150 ±5% | 3.2 | 1.6 | 1.0 | 1.5 | 0.3 min. |
| GRM31A5C2J181JW01D | DC630 | C0G (EIA) | 180 ±5% | 3.2 | 1.6 | 1.0 | 1.5 | 0.3 min. |
| GRM31A5C2J221JW01D | DC630 | C0G (EIA) | 220 ±5% | 3.2 | 1.6 | 1.0 | 1.5 | 0.3 min. |
| GRM31A5C2J271JW01D | DC630 | C0G (EIA) | 270 ±5% | 3.2 | 1.6 | 1.0 | 1.5 | 0.3 min. |
| GRM31A5C2J331JW01D | DC630 | C0G (EIA) | 330 ±5% | 3.2 | 1.6 | 1.0 | 1.5 | 0.3 min. |
| GRM31A5C2J391JW01D | DC630 | C0G (EIA) | 390 ±5% | 3.2 | 1.6 | 1.0 | 1.5 | 0.3 min. |
| GRM31A5C2J471JW01D | DC630 | C0G (EIA) | 470 ±5% | 3.2 | 1.6 | 1.0 | 1.5 | 0.3 min. |
| GRM31A5C2J561JW01D | DC630 | C0G (EIA) | 560 ±5% | 3.2 | 1.6 | 1.0 | 1.5 | 0.3 min. |
| GRM31B5C2J681JW01L | DC630 | C0G (EIA) | 680 ±5% | 3.2 | 1.6 | 1.25 | 1.5 | 0.3 min. |
| GRM31B5C2J821JW01L | DC630 | C0G (EIA) | 820 ±5% | 3.2 | 1.6 | 1.25 | 1.5 | 0.3 min. |
| GRM31B5C2J102JW01L | DC630 | C0G (EIA) | 1000 ±5% | 3.2 | 1.6 | 1.25 | 1.5 | 0.3 min. |
| GRM31A5C3A100JW01D | DC1000 | C0G (EIA) | 10 ±5% | 3.2 | 1.6 | 1.0 | 1.5 | 0.3 min. |
| GRM31A5C3A120JW01D | DC1000 | C0G (EIA) | 12 ±5% | 3.2 | 1.6 | 1.0 | 1.5 | 0.3 min. |
| GRM31A5C3A150JW01D | DC1000 | C0G (EIA) | 15 ±5% | 3.2 | 1.6 | 1.0 | 1.5 | 0.3 min. |
| GRM31A5C3A180JW01D | DC1000 | C0G (EIA) | 18 ±5% | 3.2 | 1.6 | 1.0 | 1.5 | 0.3 min. |
| GRM31A5C3A220JW01D | DC1000 | C0G (EIA) | 22 ±5% | 3.2 | 1.6 | 1.0 | 1.5 | 0.3 min. |
| GRM31A5C3A270JW01D | DC1000 | C0G (EIA) | 27 ±5% | 3.2 | 1.6 | 1.0 | 1.5 | 0.3 min. |
| GRM31A5C3A330JW01D | DC1000 | C0G (EIA) | 33 ±5% | 3.2 | 1.6 | 1.0 | 1.5 | 0.3 min. |
| GRM31A5C3A390JW01D | DC1000 | C0G (EIA) | 39 ±5% | 3.2 | 1.6 | 1.0 | 1.5 | 0.3 min. |
| GRM31A5C3A470JW01D | DC1000 | C0G (EIA) | 47 ±5% | 3.2 | 1.6 | 1.0 | 1.5 | 0.3 min. |
| GRM31A5C3A560JW01D | DC1000 | C0G (EIA) | 56 ±5% | 3.2 | 1.6 | 1.0 | 1.5 | 0.3 min. |
| GRM31A5C3A680JW01D | DC1000 | C0G (EIA) | 68 ±5% | 3.2 | 1.6 | 1.0 | 1.5 | 0.3 min. |
| GRM31A5C3A820JW01D | DC1000 | C0G (EIA) | 82 ±5% | 3.2 | 1.6 | 1.0 | 1.5 | 0.3 min. |
| GRM31A5C3A101JW01D | DC1000 | C0G (EIA) | 100 ±5% | 3.2 | 1.6 | 1.0 | 1.5 | 0.3 min. |

U2J Characteristics

| Part Number | Rated Voltage (V) | TC Code (Standard) | Capacitance (pF) | Length L (mm) | Width W (mm) | Thickness T (mm) | Electrode g min. (mm) | Electrode e (mm) |
|--------------------|-------------------|--------------------|------------------|---------------|--------------|------------------|-----------------------|------------------|
| GRM21A7U2E101JW31D | DC250 | U2J (EIA) | 100 ±5% | 2.0 | 1.25 | 1.0 | 0.7 | 0.3 min. |
| GRM21A7U2E121JW31D | DC250 | U2J (EIA) | 120 ±5% | 2.0 | 1.25 | 1.0 | 0.7 | 0.3 min. |
| GRM21A7U2E151JW31D | DC250 | U2J (EIA) | 150 ±5% | 2.0 | 1.25 | 1.0 | 0.7 | 0.3 min. |
| GRM21A7U2E181JW31D | DC250 | U2J (EIA) | 180 ±5% | 2.0 | 1.25 | 1.0 | 0.7 | 0.3 min. |
| GRM21A7U2E221JW31D | DC250 | U2J (EIA) | 220 ±5% | 2.0 | 1.25 | 1.0 | 0.7 | 0.3 min. |
| GRM21A7U2E271JW31D | DC250 | U2J (EIA) | 270 ±5% | 2.0 | 1.25 | 1.0 | 0.7 | 0.3 min. |
| GRM21A7U2E331JW31D | DC250 | U2J (EIA) | 330 ±5% | 2.0 | 1.25 | 1.0 | 0.7 | 0.3 min. |
| GRM21A7U2E391JW31D | DC250 | U2J (EIA) | 390 ±5% | 2.0 | 1.25 | 1.0 | 0.7 | 0.3 min. |
| GRM21A7U2E471JW31D | DC250 | U2J (EIA) | 470 ±5% | 2.0 | 1.25 | 1.0 | 0.7 | 0.3 min. |
| GRM21A7U2E561JW31D | DC250 | U2J (EIA) | 560 ±5% | 2.0 | 1.25 | 1.0 | 0.7 | 0.3 min. |
| GRM21A7U2E681JW31D | DC250 | U2J (EIA) | 680 ±5% | 2.0 | 1.25 | 1.0 | 0.7 | 0.3 min. |
| GRM21A7U2E821JW31D | DC250 | U2J (EIA) | 820 ±5% | 2.0 | 1.25 | 1.0 | 0.7 | 0.3 min. |
| GRM21A7U2E102JW31D | DC250 | U2J (EIA) | 1000 ±5% | 2.0 | 1.25 | 1.0 | 0.7 | 0.3 min. |
| GRM21A7U2E122JW31D | DC250 | U2J (EIA) | 1200 ±5% | 2.0 | 1.25 | 1.0 | 0.7 | 0.3 min. |
| GRM21A7U2E152JW31D | DC250 | U2J (EIA) | 1500 ±5% | 2.0 | 1.25 | 1.0 | 0.7 | 0.3 min. |
| GRM21A7U2E182JW31D | DC250 | U2J (EIA) | 1800 ±5% | 2.0 | 1.25 | 1.0 | 0.7 | 0.3 min. |
| GRM21A7U2E222JW31D | DC250 | U2J (EIA) | 2200 ±5% | 2.0 | 1.25 | 1.0 | 0.7 | 0.3 min. |
| GRM21B7U2E272JW32L | DC250 | U2J (EIA) | 2700 ±5% | 2.0 | 1.25 | 1.25 | 0.7 | 0.3 min. |
| GRM31A7U2E272JW31D | DC250 | U2J (EIA) | 2700 ±5% | 3.2 | 1.6 | 1.0 | 1.5 | 0.3 min. |
| GRM21B7U2E332JW32L | DC250 | U2J (EIA) | 3300 ±5% | 2.0 | 1.25 | 1.25 | 0.7 | 0.3 min. |
| GRM31A7U2E332JW31D | DC250 | U2J (EIA) | 3300 ±5% | 3.2 | 1.6 | 1.0 | 1.5 | 0.3 min. |
| GRM21B7U2E392JW32L | DC250 | U2J (EIA) | 3900 ±5% | 2.0 | 1.25 | 1.25 | 0.7 | 0.3 min. |
| GRM31A7U2E392JW31D | DC250 | U2J (EIA) | 3900 ±5% | 3.2 | 1.6 | 1.0 | 1.5 | 0.3 min. |

Continued on the following page. ↗

• This PDF catalog has only typical specifications because there is no space for detailed specifications. Therefore, please approve our product specifications or transact the approval sheet for product specifications before ordering.

Continued from the preceding page.

| Part Number | Rated Voltage (V) | TC Code (Standard) | Capacitance (pF) | Length L (mm) | Width W (mm) | Thickness T (mm) | Electrode g min. (mm) | Electrode e (mm) |
|--------------------|-------------------|--------------------|------------------|---------------|--------------|------------------|-----------------------|------------------|
| GRM21B7U2E472JW32L | DC250 | U2J (EIA) | 4700 ±5% | 2.0 | 1.25 | 1.25 | 0.7 | 0.3 min. |
| GRM31A7U2E472JW31D | DC250 | U2J (EIA) | 4700 ±5% | 3.2 | 1.6 | 1.0 | 1.5 | 0.3 min. |
| GRM21B7U2E562JW32L | DC250 | U2J (EIA) | 5600 ±5% | 2.0 | 1.25 | 1.25 | 0.7 | 0.3 min. |
| GRM31A7U2E562JW31D | DC250 | U2J (EIA) | 5600 ±5% | 3.2 | 1.6 | 1.0 | 1.5 | 0.3 min. |
| GRM31B7U2E682JW31L | DC250 | U2J (EIA) | 6800 ±5% | 3.2 | 1.6 | 1.25 | 1.5 | 0.3 min. |
| GRM31B7U2E822JW31L | DC250 | U2J (EIA) | 8200 ±5% | 3.2 | 1.6 | 1.25 | 1.5 | 0.3 min. |
| GRM31B7U2E103JW31L | DC250 | U2J (EIA) | 10000 ±5% | 3.2 | 1.6 | 1.25 | 1.5 | 0.3 min. |
| GRM31A7U2J100JW31D | DC630 | U2J (EIA) | 10 ±5% | 3.2 | 1.6 | 1.0 | 1.5 | 0.3 min. |
| GRM31A7U2J120JW31D | DC630 | U2J (EIA) | 12 ±5% | 3.2 | 1.6 | 1.0 | 1.5 | 0.3 min. |
| GRM31A7U2J150JW31D | DC630 | U2J (EIA) | 15 ±5% | 3.2 | 1.6 | 1.0 | 1.5 | 0.3 min. |
| GRM31A7U2J180JW31D | DC630 | U2J (EIA) | 18 ±5% | 3.2 | 1.6 | 1.0 | 1.5 | 0.3 min. |
| GRM31A7U2J220JW31D | DC630 | U2J (EIA) | 22 ±5% | 3.2 | 1.6 | 1.0 | 1.5 | 0.3 min. |
| GRM31A7U2J270JW31D | DC630 | U2J (EIA) | 27 ±5% | 3.2 | 1.6 | 1.0 | 1.5 | 0.3 min. |
| GRM31A7U2J330JW31D | DC630 | U2J (EIA) | 33 ±5% | 3.2 | 1.6 | 1.0 | 1.5 | 0.3 min. |
| GRM31A7U2J390JW31D | DC630 | U2J (EIA) | 39 ±5% | 3.2 | 1.6 | 1.0 | 1.5 | 0.3 min. |
| GRM31A7U2J470JW31D | DC630 | U2J (EIA) | 47 ±5% | 3.2 | 1.6 | 1.0 | 1.5 | 0.3 min. |
| GRM31A7U2J560JW31D | DC630 | U2J (EIA) | 56 ±5% | 3.2 | 1.6 | 1.0 | 1.5 | 0.3 min. |
| GRM31A7U2J680JW31D | DC630 | U2J (EIA) | 68 ±5% | 3.2 | 1.6 | 1.0 | 1.5 | 0.3 min. |
| GRM31A7U2J820JW31D | DC630 | U2J (EIA) | 82 ±5% | 3.2 | 1.6 | 1.0 | 1.5 | 0.3 min. |
| GRM31A7U2J101JW31D | DC630 | U2J (EIA) | 100 ±5% | 3.2 | 1.6 | 1.0 | 1.5 | 0.3 min. |
| GRM31A7U2J121JW31D | DC630 | U2J (EIA) | 120 ±5% | 3.2 | 1.6 | 1.0 | 1.5 | 0.3 min. |
| GRM31A7U2J151JW31D | DC630 | U2J (EIA) | 150 ±5% | 3.2 | 1.6 | 1.0 | 1.5 | 0.3 min. |
| GRM31A7U2J181JW31D | DC630 | U2J (EIA) | 180 ±5% | 3.2 | 1.6 | 1.0 | 1.5 | 0.3 min. |
| GRM31A7U2J221JW31D | DC630 | U2J (EIA) | 220 ±5% | 3.2 | 1.6 | 1.0 | 1.5 | 0.3 min. |
| GRM31A7U2J271JW31D | DC630 | U2J (EIA) | 270 ±5% | 3.2 | 1.6 | 1.0 | 1.5 | 0.3 min. |
| GRM31A7U2J331JW31D | DC630 | U2J (EIA) | 330 ±5% | 3.2 | 1.6 | 1.0 | 1.5 | 0.3 min. |
| GRM31A7U2J391JW31D | DC630 | U2J (EIA) | 390 ±5% | 3.2 | 1.6 | 1.0 | 1.5 | 0.3 min. |
| GRM31A7U2J471JW31D | DC630 | U2J (EIA) | 470 ±5% | 3.2 | 1.6 | 1.0 | 1.5 | 0.3 min. |
| GRM31A7U2J561JW31D | DC630 | U2J (EIA) | 560 ±5% | 3.2 | 1.6 | 1.0 | 1.5 | 0.3 min. |
| GRM31A7U2J681JW31D | DC630 | U2J (EIA) | 680 ±5% | 3.2 | 1.6 | 1.0 | 1.5 | 0.3 min. |
| GRM31A7U2J821JW31D | DC630 | U2J (EIA) | 820 ±5% | 3.2 | 1.6 | 1.0 | 1.5 | 0.3 min. |
| GRM31A7U2J102JW31D | DC630 | U2J (EIA) | 1000 ±5% | 3.2 | 1.6 | 1.0 | 1.5 | 0.3 min. |
| GRM32A7U2J122JW31D | DC630 | U2J (EIA) | 1200 ±5% | 3.2 | 2.5 | 1.0 | 1.5 | 0.3 min. |
| GRM32A7U2J152JW31D | DC630 | U2J (EIA) | 1500 ±5% | 3.2 | 2.5 | 1.0 | 1.5 | 0.3 min. |
| GRM32A7U2J182JW31D | DC630 | U2J (EIA) | 1800 ±5% | 3.2 | 2.5 | 1.0 | 1.5 | 0.3 min. |
| GRM32A7U2J222JW31D | DC630 | U2J (EIA) | 2200 ±5% | 3.2 | 2.5 | 1.0 | 1.5 | 0.3 min. |
| GRM31A7U3A100JW31D | DC1000 | U2J (EIA) | 10 ±5% | 3.2 | 1.6 | 1.0 | 1.5 | 0.3 min. |
| GRM31A7U3A120JW31D | DC1000 | U2J (EIA) | 12 ±5% | 3.2 | 1.6 | 1.0 | 1.5 | 0.3 min. |
| GRM31A7U3A150JW31D | DC1000 | U2J (EIA) | 15 ±5% | 3.2 | 1.6 | 1.0 | 1.5 | 0.3 min. |
| GRM31A7U3A180JW31D | DC1000 | U2J (EIA) | 18 ±5% | 3.2 | 1.6 | 1.0 | 1.5 | 0.3 min. |
| GRM31A7U3A220JW31D | DC1000 | U2J (EIA) | 22 ±5% | 3.2 | 1.6 | 1.0 | 1.5 | 0.3 min. |
| GRM31A7U3A270JW31D | DC1000 | U2J (EIA) | 27 ±5% | 3.2 | 1.6 | 1.0 | 1.5 | 0.3 min. |
| GRM31A7U3A330JW31D | DC1000 | U2J (EIA) | 33 ±5% | 3.2 | 1.6 | 1.0 | 1.5 | 0.3 min. |
| GRM31A7U3A390JW31D | DC1000 | U2J (EIA) | 39 ±5% | 3.2 | 1.6 | 1.0 | 1.5 | 0.3 min. |
| GRM31A7U3A470JW31D | DC1000 | U2J (EIA) | 47 ±5% | 3.2 | 1.6 | 1.0 | 1.5 | 0.3 min. |
| GRM31A7U3A560JW31D | DC1000 | U2J (EIA) | 56 ±5% | 3.2 | 1.6 | 1.0 | 1.5 | 0.3 min. |
| GRM31A7U3A680JW31D | DC1000 | U2J (EIA) | 68 ±5% | 3.2 | 1.6 | 1.0 | 1.5 | 0.3 min. |
| GRM31A7U3A820JW31D | DC1000 | U2J (EIA) | 82 ±5% | 3.2 | 1.6 | 1.0 | 1.5 | 0.3 min. |
| GRM31A7U3A101JW31D | DC1000 | U2J (EIA) | 100 ±5% | 3.2 | 1.6 | 1.0 | 1.5 | 0.3 min. |
| GRM31A7U3A121JW31D | DC1000 | U2J (EIA) | 120 ±5% | 3.2 | 1.6 | 1.0 | 1.5 | 0.3 min. |
| GRM31A7U3A151JW31D | DC1000 | U2J (EIA) | 150 ±5% | 3.2 | 1.6 | 1.0 | 1.5 | 0.3 min. |
| GRM31A7U3A181JW31D | DC1000 | U2J (EIA) | 180 ±5% | 3.2 | 1.6 | 1.0 | 1.5 | 0.3 min. |
| GRM31A7U3A221JW31D | DC1000 | U2J (EIA) | 220 ±5% | 3.2 | 1.6 | 1.0 | 1.5 | 0.3 min. |
| GRM31A7U3A271JW31D | DC1000 | U2J (EIA) | 270 ±5% | 3.2 | 1.6 | 1.0 | 1.5 | 0.3 min. |
| GRM31A7U3A331JW31D | DC1000 | U2J (EIA) | 330 ±5% | 3.2 | 1.6 | 1.0 | 1.5 | 0.3 min. |
| GRM31B7U3A391JW31L | DC1000 | U2J (EIA) | 390 ±5% | 3.2 | 1.6 | 1.25 | 1.5 | 0.3 min. |
| GRM31B7U3A471JW31L | DC1000 | U2J (EIA) | 470 ±5% | 3.2 | 1.6 | 1.25 | 1.5 | 0.3 min. |

Continued on the following page. ↗

Continued from the preceding page.

| Part Number | Rated Voltage (V) | TC Code (Standard) | Capacitance (pF) | Length L (mm) | Width W (mm) | Thickness T (mm) | Electrode g min. (mm) | Electrode e (mm) |
|--------------------|-------------------|--------------------|------------------|---------------|--------------|------------------|-----------------------|------------------|
| GRM31A7U3D100JW31D | DC2000 | U2J (EIA) | 10 ±5% | 3.2 | 1.6 | 1.0 | 1.8 | 0.3 min. |
| GRM31A7U3D120JW31D | DC2000 | U2J (EIA) | 12 ±5% | 3.2 | 1.6 | 1.0 | 1.8 | 0.3 min. |
| GRM31A7U3D150JW31D | DC2000 | U2J (EIA) | 15 ±5% | 3.2 | 1.6 | 1.0 | 1.8 | 0.3 min. |
| GRM31A7U3D180JW31D | DC2000 | U2J (EIA) | 18 ±5% | 3.2 | 1.6 | 1.0 | 1.8 | 0.3 min. |
| GRM31A7U3D220JW31D | DC2000 | U2J (EIA) | 22 ±5% | 3.2 | 1.6 | 1.0 | 1.8 | 0.3 min. |
| GRM31A7U3D270JW31D | DC2000 | U2J (EIA) | 27 ±5% | 3.2 | 1.6 | 1.0 | 1.8 | 0.3 min. |
| GRM31A7U3D330JW31D | DC2000 | U2J (EIA) | 33 ±5% | 3.2 | 1.6 | 1.0 | 1.8 | 0.3 min. |
| GRM31A7U3D390JW31D | DC2000 | U2J (EIA) | 39 ±5% | 3.2 | 1.6 | 1.0 | 1.8 | 0.3 min. |
| GRM31A7U3D470JW31D | DC2000 | U2J (EIA) | 47 ±5% | 3.2 | 1.6 | 1.0 | 1.8 | 0.3 min. |
| GRM31A7U3D560JW31D | DC2000 | U2J (EIA) | 56 ±5% | 3.2 | 1.6 | 1.0 | 1.8 | 0.3 min. |
| GRM31A7U3D680JW31D | DC2000 | U2J (EIA) | 68 ±5% | 3.2 | 1.6 | 1.0 | 1.8 | 0.3 min. |
| GRM32A7U3D820JW31D | DC2000 | U2J (EIA) | 82 ±5% | 3.2 | 2.5 | 1.0 | 1.8 | 0.3 min. |
| GRM32A7U3D101JW31D | DC2000 | U2J (EIA) | 100 ±5% | 3.2 | 2.5 | 1.0 | 1.8 | 0.3 min. |
| GRM32A7U3D121JW31D | DC2000 | U2J (EIA) | 120 ±5% | 3.2 | 2.5 | 1.0 | 1.8 | 0.3 min. |
| GRM32A7U3D151JW31D | DC2000 | U2J (EIA) | 150 ±5% | 3.2 | 2.5 | 1.0 | 1.8 | 0.3 min. |
| GRM32B7U3D181JW31L | DC2000 | U2J (EIA) | 180 ±5% | 3.2 | 2.5 | 1.25 | 1.8 | 0.3 min. |
| GRM32B7U3D221JW31L | DC2000 | U2J (EIA) | 220 ±5% | 3.2 | 2.5 | 1.25 | 1.8 | 0.3 min. |
| GRM42A7U3F270JW31L | DC3150 | U2J (EIA) | 27 ±5% | 4.5 | 2.0 | 1.0 | 2.9 | 0.3 min. |
| GRM42A7U3F330JW31L | DC3150 | U2J (EIA) | 33 ±5% | 4.5 | 2.0 | 1.0 | 2.9 | 0.3 min. |
| GRM42A7U3F390JW31L | DC3150 | U2J (EIA) | 39 ±5% | 4.5 | 2.0 | 1.0 | 2.9 | 0.3 min. |
| GRM42A7U3F470JW31L | DC3150 | U2J (EIA) | 47 ±5% | 4.5 | 2.0 | 1.0 | 2.9 | 0.3 min. |
| GRM42A7U3F560JW31L | DC3150 | U2J (EIA) | 56 ±5% | 4.5 | 2.0 | 1.0 | 2.9 | 0.3 min. |
| GRM42A7U3F680JW31L | DC3150 | U2J (EIA) | 68 ±5% | 4.5 | 2.0 | 1.0 | 2.9 | 0.3 min. |
| GRM42A7U3F820JW31L | DC3150 | U2J (EIA) | 82 ±5% | 4.5 | 2.0 | 1.0 | 2.9 | 0.3 min. |
| GRM42A7U3F101JW31L | DC3150 | U2J (EIA) | 100 ±5% | 4.5 | 2.0 | 1.0 | 2.9 | 0.3 min. |

For General Purpose
GRM/GRJ Series

Only for Applications

AC250V Type
GA2 Series

Safety Standard
Certified GA3 Series

Product Information

GRM Series Specifications and Test Methods

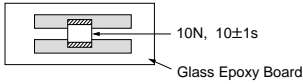
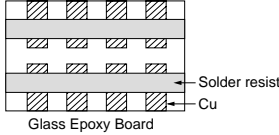
| No. | Item | Specifications | Test Method | | | | | | | | | | | | |
|------------------------|---|--|---|---------------|------------------|---------|---------------------------|----------|---------------------------|------------------------|---------------------------|------------------|------------------------|---|------|
| 1 | Operating Temperature Range | -55 to +125°C | - | | | | | | | | | | | | |
| 2 | Appearance | No defects or abnormalities | Visual inspection | | | | | | | | | | | | |
| 3 | Dimensions | Within the specified dimension | Using calipers and micrometers | | | | | | | | | | | | |
| 4 | Dielectric Strength | No defects or abnormalities | <p>No failure should be observed when voltage in the Table is applied between the terminations for 1 to 5 sec., provided the charge/discharge current is less than 50mA.</p> <table border="1"> <thead> <tr> <th>Rated Voltage</th> <th>Test Voltage</th> </tr> </thead> <tbody> <tr> <td>DC250V</td> <td>200% of the rated voltage</td> </tr> <tr> <td>DC630V</td> <td>150% of the rated voltage</td> </tr> <tr> <td>DC1kV, DC2kV, DC3.15kV</td> <td>130% of the rated voltage</td> </tr> </tbody> </table> | Rated Voltage | Test Voltage | DC250V | 200% of the rated voltage | DC630V | 150% of the rated voltage | DC1kV, DC2kV, DC3.15kV | 130% of the rated voltage | | | | |
| Rated Voltage | Test Voltage | | | | | | | | | | | | | | |
| DC250V | 200% of the rated voltage | | | | | | | | | | | | | | |
| DC630V | 150% of the rated voltage | | | | | | | | | | | | | | |
| DC1kV, DC2kV, DC3.15kV | 130% of the rated voltage | | | | | | | | | | | | | | |
| 5 | Insulation Resistance (I.R.) | More than 10,000MΩ | The insulation resistance should be measured with DC500±50V (DC250±25V in case of rated voltage: DC250V) and within 60±5 sec. of charging. | | | | | | | | | | | | |
| 6 | Capacitance | Within the specified tolerance | The capacitance/Q should be measured at the frequency and voltage shown as follows. | | | | | | | | | | | | |
| 7 | Q | 1,000 min. | <table border="1"> <thead> <tr> <th>Capacitance</th> <th>Frequency</th> <th>Voltage</th> </tr> </thead> <tbody> <tr> <td>C<1,000pF</td> <td>1±0.2MHz</td> <td>AC0.5 to 5V(r.m.s.)</td> </tr> <tr> <td>C≥1,000pF</td> <td>1±0.2kHz</td> <td>AC1±0.2V(r.m.s.)</td> </tr> </tbody> </table> | Capacitance | Frequency | Voltage | C<1,000pF | 1±0.2MHz | AC0.5 to 5V(r.m.s.) | C≥1,000pF | 1±0.2kHz | AC1±0.2V(r.m.s.) | | | |
| Capacitance | Frequency | Voltage | | | | | | | | | | | | | |
| C<1,000pF | 1±0.2MHz | AC0.5 to 5V(r.m.s.) | | | | | | | | | | | | | |
| C≥1,000pF | 1±0.2kHz | AC1±0.2V(r.m.s.) | | | | | | | | | | | | | |
| 8 | Capacitance Temperature Characteristics | Temp. Coefficient C0G char. : 0±30ppm/°C (Temp. Range : +25 to +125°C) 0+30, -72ppm/°C (Temp. Range : -55 to +25°C) U2J char. : -750±120ppm/°C (Temp. Range : +25 to +125°C) -750+120, -347ppm/°C (Temp. Range : -55 to +25°C) | The capacitance measurement should be made at each step specified in the Table. <table border="1"> <thead> <tr> <th>Step</th> <th>Temperature (°C)</th> </tr> </thead> <tbody> <tr> <td>1</td> <td>25±2</td> </tr> <tr> <td>2</td> <td>Min. Operating Temp.±3</td> </tr> <tr> <td>3</td> <td>25±2</td> </tr> <tr> <td>4</td> <td>Max. Operating Temp.±2</td> </tr> <tr> <td>5</td> <td>25±2</td> </tr> </tbody> </table> | Step | Temperature (°C) | 1 | 25±2 | 2 | Min. Operating Temp.±3 | 3 | 25±2 | 4 | Max. Operating Temp.±2 | 5 | 25±2 |
| Step | Temperature (°C) | | | | | | | | | | | | | | |
| 1 | 25±2 | | | | | | | | | | | | | | |
| 2 | Min. Operating Temp.±3 | | | | | | | | | | | | | | |
| 3 | 25±2 | | | | | | | | | | | | | | |
| 4 | Max. Operating Temp.±2 | | | | | | | | | | | | | | |
| 5 | 25±2 | | | | | | | | | | | | | | |
| 9 | Adhesive Strength of Termination | No removal of the terminations or other defect should occur. | Solder the capacitor to the testing jig (glass epoxy board) shown in Fig. 1. Then apply 10N force in the direction of the arrow. The soldering should be done using the reflow method and should be conducted with care so that the soldering is uniform and free of defects such as heat shock.  <p style="text-align: center;">Fig. 1</p> | | | | | | | | | | | | |
| 10 | Appearance | No defects or abnormalities | Solder the capacitor to the test jig (glass epoxy board). The capacitor should be subjected to a simple harmonic motion having a total amplitude of 1.5mm, the frequency being varied uniformly between the approximate limits of 10 and 55Hz. The frequency range, from 10 to 55Hz and return to 10Hz, should be traversed in approximately 1 min. This motion should be applied for a period of 2 hrs. in each of 3 mutually perpendicular directions (total of 6 hrs.).  | | | | | | | | | | | | |
| | Capacitance | Within the specified tolerance | | | | | | | | | | | | | |
| | Q | 1,000 min. | | | | | | | | | | | | | |

Continued on the following page. 

For General Purpose GRM/GRJ Series

Only for Applications

AC250V Type GA2 Series

Safety Standard Certified GA3 Series

Product Information

GRM Series Specifications and Test Methods

Continued from the preceding page.

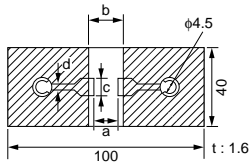
| No. | Item | Specifications | Test Method | | | | | | | | | | | | | | | | | | | | | | | |
|----------|------------------------------|--|---|----------|----------------|--|--|--|---|---|---|---|----------|-----|-----|------|-----|---------|-----|-----|-----|---------|-----|-----|-----|---------|
| 11 | Deflection | No marking defects | Solder the capacitor to the testing jig (glass epoxy board) shown in Fig. 2. Then apply a force in the direction shown in Fig. 3. The soldering should be done using the reflow method and should be conducted with care so that the soldering is uniform and free of defects such as heat shock. | | | | | | | | | | | | | | | | | | | | | | | |
| | |  <table border="1" data-bbox="371 526 880 676"> <thead> <tr> <th rowspan="2">LxW (mm)</th> <th colspan="4">Dimension (mm)</th> </tr> <tr> <th>a</th> <th>b</th> <th>c</th> <th>d</th> </tr> </thead> <tbody> <tr> <td>2.0x1.25</td> <td>1.2</td> <td>4.0</td> <td>1.65</td> <td rowspan="4">1.0</td> </tr> <tr> <td>3.2x1.6</td> <td>2.2</td> <td>5.0</td> <td>2.0</td> </tr> <tr> <td>3.2x2.5</td> <td>2.2</td> <td>5.0</td> <td>2.9</td> </tr> <tr> <td>4.5x2.0</td> <td>3.5</td> <td>7.0</td> <td>2.4</td> </tr> </tbody> </table> | | LxW (mm) | Dimension (mm) | | | | a | b | c | d | 2.0x1.25 | 1.2 | 4.0 | 1.65 | 1.0 | 3.2x1.6 | 2.2 | 5.0 | 2.0 | 3.2x2.5 | 2.2 | 5.0 | 2.9 | 4.5x2.0 |
| LxW (mm) | Dimension (mm) | | | | | | | | | | | | | | | | | | | | | | | | | |
| | a | b | c | d | | | | | | | | | | | | | | | | | | | | | | |
| 2.0x1.25 | 1.2 | 4.0 | 1.65 | 1.0 | | | | | | | | | | | | | | | | | | | | | | |
| 3.2x1.6 | 2.2 | 5.0 | 2.0 | | | | | | | | | | | | | | | | | | | | | | | |
| 3.2x2.5 | 2.2 | 5.0 | 2.9 | | | | | | | | | | | | | | | | | | | | | | | |
| 4.5x2.0 | 3.5 | 7.0 | 2.4 | | | | | | | | | | | | | | | | | | | | | | | |
| 12 | Solderability of Termination | 75% of the terminations are to be soldered evenly and continuously. | Immerse the capacitor in a solution of ethanol (JIS-K-8101) and rosin (JIS-K-5902) (25% rosin in weight proportion). Immerse in solder solution for 2±0.5 sec. Immersing speed: 25±2.5mm/s Temp. of solder: 245±5°C Lead Free Solder (Sn-3.0Ag-0.5Cu) 235±5°C H60A or H63A Eutectic Solder | | | | | | | | | | | | | | | | | | | | | | | |
| 13 | Resistance to Soldering Heat | Appearance | No marking defects | | | | | | | | | | | | | | | | | | | | | | | |
| | | Capacitance Change | Within ±2.5% | | | | | | | | | | | | | | | | | | | | | | | |
| | | Q | 1,000 min. | | | | | | | | | | | | | | | | | | | | | | | |
| | | I.R. | More than 10,000MΩ | | | | | | | | | | | | | | | | | | | | | | | |
| | | Dielectric Strength | In accordance with item No.4 | | | | | | | | | | | | | | | | | | | | | | | |
| 14 | Temperature Cycle | Appearance | No marking defects | | | | | | | | | | | | | | | | | | | | | | | |
| | | Capacitance Change | Within ±2.5% | | | | | | | | | | | | | | | | | | | | | | | |
| | | Q | 500 min. | | | | | | | | | | | | | | | | | | | | | | | |
| | | I.R. | More than 10,000MΩ | | | | | | | | | | | | | | | | | | | | | | | |
| | | Dielectric Strength | In accordance with item No.4 | | | | | | | | | | | | | | | | | | | | | | | |
| 15 | Humidity (Steady State) | Appearance | No marking defects | | | | | | | | | | | | | | | | | | | | | | | |
| | | Capacitance Change | Within ±5.0% | | | | | | | | | | | | | | | | | | | | | | | |
| | | Q | 350 min. | | | | | | | | | | | | | | | | | | | | | | | |
| | | I.R. | More than 1,000MΩ | | | | | | | | | | | | | | | | | | | | | | | |
| | | Dielectric Strength | In accordance with item No.4 | | | | | | | | | | | | | | | | | | | | | | | |
| 16 | Life | Appearance | No marking defects | | | | | | | | | | | | | | | | | | | | | | | |
| | | Capacitance Change | Within ±3.0% | | | | | | | | | | | | | | | | | | | | | | | |
| | | Q | 350 min. | | | | | | | | | | | | | | | | | | | | | | | |
| | | I.R. | More than 1,000MΩ | | | | | | | | | | | | | | | | | | | | | | | |
| | | Dielectric Strength | In accordance with item No.4 | | | | | | | | | | | | | | | | | | | | | | | |

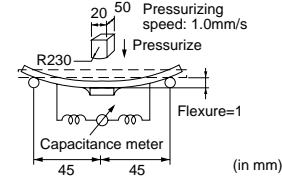

Fig. 3

| Step | Temperature | Time |
|------|--------------|--------|
| 1 | 100 to 120°C | 1 min. |
| 2 | 170 to 200°C | 1 min. |

| Step | Temperature (°C) | Time (min.) |
|------|------------------------|-------------|
| 1 | Min. Operating Temp.±3 | 30±3 |
| 2 | Room Temp. | 2 to 3 |
| 3 | Max. Operating Temp.±2 | 30±3 |
| 4 | Room Temp. | 2 to 3 |

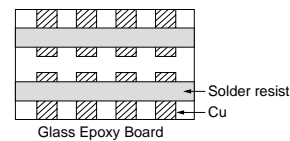

Fig. 4

| Rated Voltage | Applied Voltage |
|--------------------------------|---------------------------|
| DC250V | 150% of the rated voltage |
| DC630V, DC1kV, DC2kV, DC3.15kV | 120% of the rated voltage |

The charge/discharge current is less than 50mA.

* "Room condition" Temperature: 15 to 35°C, Relative humidity: 45 to 75%, Atmospheric pressure: 86 to 106kPa

For General Purpose
GRM/GRJ Series

Only for Applications

AC250V Type
GA2 Series

Safety Standard
Certified GA3 Series

Product Information

Chip Monolithic Ceramic Capacitors (Medium Voltage)



High Capacitance for General Use GRM Series

■ Features

1. A new monolithic structure for small, high capacitance capable of operating at high voltage levels.
2. Sn-plated external electrodes provide good solderability.
3. Use the GRM18/21/31 types with flow or reflow soldering, and other types with reflow soldering only.

■ Applications

1. Ideal for use on diode-snubber circuits for switching power supplies.
2. Ideal for use as primary-secondary coupling for DC-DC converters.
3. Ideal for use on line filters and ringer detectors for telephones, facsimiles and modems.

Do not use these products in any Automotive Power train or Safety equipment including Battery chargers for Electric Vehicles and Plug-in Hybrids. Only Murata products clearly stipulated as "for Automotive use" can be used for automobile applications such as Power train and Safety equipment.

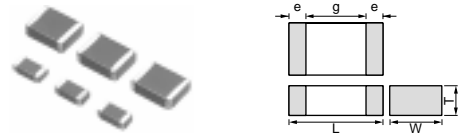

| Part Number | Dimensions (mm) | | | | | |
|-------------|-----------------|-----------|--------------|------------|--------|-----|
| | L | W | T | e | g min. | |
| GRM188 | 1.6 ±0.1 | 0.8 ±0.1 | 0.8 ±0.1 | 0.2 to 0.5 | 0.4 | |
| GRM21A | 2.0 ±0.2 | 1.25 ±0.2 | 1.0 +0,-0.3 | | | |
| GRM21B | | | 1.25 ±0.2 | | | |
| GRM31B | 3.2 ±0.2 | 1.6 ±0.2 | 1.25 +0,-0.3 | 0.3 min. | 1.2 | |
| GRM31C | | | 1.6 ±0.2 | | | |
| GRM32Q | 3.2 ±0.3 | 2.5 ±0.2 | 1.5 +0,-0.3 | | | |
| GRM32D | | | 2.0 +0,-0.3 | | | |
| GRM43Q | 4.5 ±0.4 | 3.2 ±0.3 | 1.5 +0,-0.3 | | | 2.2 |
| GRM43D | | | 2.0 +0,-0.3 | | | |
| GRM55D | 5.7 ±0.4 | 5.0 ±0.4 | 2.0 +0,-0.3 | 3.2 | | |

| Part Number | Rated Voltage (V) | TC Code (Standard) | Capacitance | Length L (mm) | Width W (mm) | Thickness T (mm) | Electrode g min. (mm) | Electrode e (mm) |
|--------------------|-------------------|--------------------|--------------|---------------|--------------|------------------|-----------------------|------------------|
| GRM188R72E221KW07D | DC250 | X7R (EIA) | 220pF ±10% | 1.6 | 0.8 | 0.8 | 0.4 | 0.2 to 0.5 |
| GRM188R72E331KW07D | DC250 | X7R (EIA) | 330pF ±10% | 1.6 | 0.8 | 0.8 | 0.4 | 0.2 to 0.5 |
| GRM188R72E471KW07D | DC250 | X7R (EIA) | 470pF ±10% | 1.6 | 0.8 | 0.8 | 0.4 | 0.2 to 0.5 |
| GRM188R72E681KW07D | DC250 | X7R (EIA) | 680pF ±10% | 1.6 | 0.8 | 0.8 | 0.4 | 0.2 to 0.5 |
| GRM188R72E102KW07D | DC250 | X7R (EIA) | 1000pF ±10% | 1.6 | 0.8 | 0.8 | 0.4 | 0.2 to 0.5 |
| GRM21AR72E102KW01D | DC250 | X7R (EIA) | 1000pF ±10% | 2.0 | 1.25 | 1.0 | 0.7 | 0.3 min. |
| GRM188R72E152KW07D | DC250 | X7R (EIA) | 1500pF ±10% | 1.6 | 0.8 | 0.8 | 0.4 | 0.2 to 0.5 |
| GRM21AR72E152KW01D | DC250 | X7R (EIA) | 1500pF ±10% | 2.0 | 1.25 | 1.0 | 0.7 | 0.3 min. |
| GRM188R72E222KW07D | DC250 | X7R (EIA) | 2200pF ±10% | 1.6 | 0.8 | 0.8 | 0.4 | 0.2 to 0.5 |
| GRM21AR72E222KW01D | DC250 | X7R (EIA) | 2200pF ±10% | 2.0 | 1.25 | 1.0 | 0.7 | 0.3 min. |
| GRM21AR72E332KW01D | DC250 | X7R (EIA) | 3300pF ±10% | 2.0 | 1.25 | 1.0 | 0.7 | 0.3 min. |
| GRM21AR72E472KW01D | DC250 | X7R (EIA) | 4700pF ±10% | 2.0 | 1.25 | 1.0 | 0.7 | 0.3 min. |
| GRM21AR72E682KW01D | DC250 | X7R (EIA) | 6800pF ±10% | 2.0 | 1.25 | 1.0 | 0.7 | 0.3 min. |
| GRM21BR72E103KW03L | DC250 | X7R (EIA) | 10000pF ±10% | 2.0 | 1.25 | 1.25 | 0.7 | 0.3 min. |
| GRM31BR72E153KW01L | DC250 | X7R (EIA) | 15000pF ±10% | 3.2 | 1.6 | 1.25 | 1.2 | 0.3 min. |
| GRM31BR72E223KW01L | DC250 | X7R (EIA) | 22000pF ±10% | 3.2 | 1.6 | 1.25 | 1.2 | 0.3 min. |
| GRM31CR72E333KW03L | DC250 | X7R (EIA) | 33000pF ±10% | 3.2 | 1.6 | 1.6 | 1.2 | 0.3 min. |
| GRM31CR72E473KW03L | DC250 | X7R (EIA) | 47000pF ±10% | 3.2 | 1.6 | 1.6 | 1.2 | 0.3 min. |
| GRM31BR72E683KW01L | DC250 | X7R (EIA) | 68000pF ±10% | 3.2 | 1.6 | 1.25 | 1.2 | 0.3 min. |
| GRM32QR72E683KW01L | DC250 | X7R (EIA) | 68000pF ±10% | 3.2 | 2.5 | 1.5 | 1.2 | 0.3 min. |
| GRM31CR72E104KW03L | DC250 | X7R (EIA) | 0.10µF ±10% | 3.2 | 1.6 | 1.6 | 1.2 | 0.3 min. |
| GRM32DR72E104KW01L | DC250 | X7R (EIA) | 0.10µF ±10% | 3.2 | 2.5 | 2.0 | 1.2 | 0.3 min. |
| GRM32QR72E154KW01L | DC250 | X7R (EIA) | 0.15µF ±10% | 3.2 | 2.5 | 1.5 | 1.2 | 0.3 min. |
| GRM43QR72E154KW01L | DC250 | X7R (EIA) | 0.15µF ±10% | 4.5 | 3.2 | 1.5 | 2.2 | 0.3 min. |
| GRM32DR72E224KW01L | DC250 | X7R (EIA) | 0.22µF ±10% | 3.2 | 2.5 | 2.0 | 1.2 | 0.3 min. |

Continued on the following page. ↗



Continued from the preceding page.

| Part Number | Rated Voltage (V) | TC Code (Standard) | Capacitance | Length L (mm) | Width W (mm) | Thickness T (mm) | Electrode g min. (mm) | Electrode e (mm) |
|--------------------|-------------------|--------------------|--------------|---------------|--------------|------------------|-----------------------|------------------|
| GRM43DR72E224KW01L | DC250 | X7R (EIA) | 0.22μF ±10% | 4.5 | 3.2 | 2.0 | 2.2 | 0.3 min. |
| GRM43DR72E334KW01L | DC250 | X7R (EIA) | 0.33μF ±10% | 4.5 | 3.2 | 2.0 | 2.2 | 0.3 min. |
| GRM55DR72E334KW01L | DC250 | X7R (EIA) | 0.33μF ±10% | 5.7 | 5.0 | 2.0 | 3.2 | 0.3 min. |
| GRM43DR72E474KW01L | DC250 | X7R (EIA) | 0.47μF ±10% | 4.5 | 3.2 | 2.0 | 2.2 | 0.3 min. |
| GRM55DR72E474KW01L | DC250 | X7R (EIA) | 0.47μF ±10% | 5.7 | 5.0 | 2.0 | 3.2 | 0.3 min. |
| GRM55DR72E105KW01L | DC250 | X7R (EIA) | 1.0μF ±10% | 5.7 | 5.0 | 2.0 | 3.2 | 0.3 min. |
| GRM31BR72J102KW01L | DC630 | X7R (EIA) | 1000pF ±10% | 3.2 | 1.6 | 1.25 | 1.2 | 0.3 min. |
| GRM31BR72J152KW01L | DC630 | X7R (EIA) | 1500pF ±10% | 3.2 | 1.6 | 1.25 | 1.2 | 0.3 min. |
| GRM31BR72J222KW01L | DC630 | X7R (EIA) | 2200pF ±10% | 3.2 | 1.6 | 1.25 | 1.2 | 0.3 min. |
| GRM31BR72J332KW01L | DC630 | X7R (EIA) | 3300pF ±10% | 3.2 | 1.6 | 1.25 | 1.2 | 0.3 min. |
| GRM31BR72J472KW01L | DC630 | X7R (EIA) | 4700pF ±10% | 3.2 | 1.6 | 1.25 | 1.2 | 0.3 min. |
| GRM31BR72J682KW01L | DC630 | X7R (EIA) | 6800pF ±10% | 3.2 | 1.6 | 1.25 | 1.2 | 0.3 min. |
| GRM31BR72J103KW01L | DC630 | X7R (EIA) | 10000pF ±10% | 3.2 | 1.6 | 1.25 | 1.2 | 0.3 min. |
| GRM31CR72J153KW03L | DC630 | X7R (EIA) | 15000pF ±10% | 3.2 | 1.6 | 1.6 | 1.2 | 0.3 min. |
| GRM32QR72J223KW01L | DC630 | X7R (EIA) | 22000pF ±10% | 3.2 | 2.5 | 1.5 | 1.2 | 0.3 min. |
| GRM32DR72J333KW01L | DC630 | X7R (EIA) | 33000pF ±10% | 3.2 | 2.5 | 2.0 | 1.2 | 0.3 min. |
| GRM32DR72J473KW01L | DC630 | X7R (EIA) | 47000pF ±10% | 3.2 | 2.5 | 2.0 | 1.2 | 0.3 min. |
| GRM43QR72J683KW01L | DC630 | X7R (EIA) | 68000pF ±10% | 4.5 | 3.2 | 1.5 | 2.2 | 0.3 min. |
| GRM43DR72J104KW01L | DC630 | X7R (EIA) | 0.10μF ±10% | 4.5 | 3.2 | 2.0 | 2.2 | 0.3 min. |
| GRM55DR72J154KW01L | DC630 | X7R (EIA) | 0.15μF ±10% | 5.7 | 5.0 | 2.0 | 3.2 | 0.3 min. |
| GRM55DR72J224KW01L | DC630 | X7R (EIA) | 0.22μF ±10% | 5.7 | 5.0 | 2.0 | 3.2 | 0.3 min. |
| GRM31BR73A471KW01L | DC1000 | X7R (EIA) | 470pF ±10% | 3.2 | 1.6 | 1.25 | 1.2 | 0.3 min. |
| GRM31BR73A102KW01L | DC1000 | X7R (EIA) | 1000pF ±10% | 3.2 | 1.6 | 1.25 | 1.2 | 0.3 min. |
| GRM31BR73A152KW01L | DC1000 | X7R (EIA) | 1500pF ±10% | 3.2 | 1.6 | 1.25 | 1.2 | 0.3 min. |
| GRM31BR73A222KW01L | DC1000 | X7R (EIA) | 2200pF ±10% | 3.2 | 1.6 | 1.25 | 1.2 | 0.3 min. |
| GRM31BR73A332KW01L | DC1000 | X7R (EIA) | 3300pF ±10% | 3.2 | 1.6 | 1.25 | 1.2 | 0.3 min. |
| GRM31BR73A472KW01L | DC1000 | X7R (EIA) | 4700pF ±10% | 3.2 | 1.6 | 1.25 | 1.2 | 0.3 min. |
| GRM32QR73A682KW01L | DC1000 | X7R (EIA) | 6800pF ±10% | 3.2 | 2.5 | 1.5 | 1.2 | 0.3 min. |
| GRM32QR73A103KW01L | DC1000 | X7R (EIA) | 10000pF ±10% | 3.2 | 2.5 | 1.5 | 1.2 | 0.3 min. |
| GRM32DR73A153KW01L | DC1000 | X7R (EIA) | 15000pF ±10% | 3.2 | 2.5 | 2.0 | 1.2 | 0.3 min. |
| GRM32DR73A223KW01L | DC1000 | X7R (EIA) | 22000pF ±10% | 3.2 | 2.5 | 2.0 | 1.2 | 0.3 min. |
| GRM43DR73A333KW01L | DC1000 | X7R (EIA) | 33000pF ±10% | 4.5 | 3.2 | 2.0 | 2.2 | 0.3 min. |
| GRM43DR73A473KW01L | DC1000 | X7R (EIA) | 47000pF ±10% | 4.5 | 3.2 | 2.0 | 2.2 | 0.3 min. |
| GRM55DR73A104KW01L | DC1000 | X7R (EIA) | 0.10μF ±10% | 5.7 | 5.0 | 2.0 | 3.2 | 0.3 min. |

For General Purpose
GRM/GRJ Series

Only for Applications

AC250V Type
GA2 Series

Safety Standard
Certified GA3 Series

Product Information

GRM Series Specifications and Test Methods

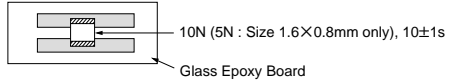
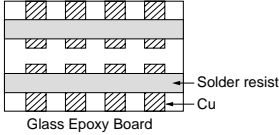
| No. | Item | Specifications | Test Method | | | | | | | | | | | | |
|------|---|--|---|------|------------------|---|------------|---|------------------------------|---|------------|---|------------------------------|---|------------|
| 1 | Operating Temperature Range | -55 to +125°C | - | | | | | | | | | | | | |
| 2 | Appearance | No defects or abnormalities | Visual inspection | | | | | | | | | | | | |
| 3 | Dimensions | Within the specified dimensions | Using calipers and micrometers | | | | | | | | | | | | |
| 4 | Dielectric Strength | No defects or abnormalities | No failure should be observed when 150% of the rated voltage (200% of the rated voltage in case of rated voltage: DC250V, 120% of the rated voltage in case of rated voltage: DC1kV) is applied between the terminations for 1 to 5 sec., provided the charge/discharge current is less than 50mA. | | | | | | | | | | | | |
| 5 | Insulation Resistance (I.R.) | C \geq 0.01 μ F: More than 100M Ω • μ F C<0.01 μ F: More than 10,000M Ω | The insulation resistance should be measured with DC500 \pm 50V (DC250 \pm 25V in case of rated voltage: DC250V) and within 60 \pm 5 sec. of charging. | | | | | | | | | | | | |
| 6 | Capacitance | Within the specified tolerance | The capacitance/D.F. should be measured at a frequency of 1 \pm 0.2kHz and a voltage of AC1 \pm 0.2V(r.m.s.) | | | | | | | | | | | | |
| 7 | Dissipation Factor (D.F.) | 0.025 max. | | | | | | | | | | | | | |
| 8 | Capacitance Temperature Characteristics | Cap. Change Within \pm 15% (Temp. Range: -55 to +125°C) | <p>The capacitance measurement should be made at each step specified in the Table.</p> <table border="1"> <thead> <tr> <th>Step</th> <th>Temperature (°C)</th> </tr> </thead> <tbody> <tr> <td>1</td> <td>25\pm2</td> </tr> <tr> <td>2</td> <td>Min. Operating Temp.\pm3</td> </tr> <tr> <td>3</td> <td>25\pm2</td> </tr> <tr> <td>4</td> <td>Max. Operating Temp.\pm2</td> </tr> <tr> <td>5</td> <td>25\pm2</td> </tr> </tbody> </table> <p>•Pretreatment Perform a heat treatment at 150\pm9°C for 60\pm5 min. and then let sit for 24\pm2 hrs. at room condition.*</p> | Step | Temperature (°C) | 1 | 25 \pm 2 | 2 | Min. Operating Temp. \pm 3 | 3 | 25 \pm 2 | 4 | Max. Operating Temp. \pm 2 | 5 | 25 \pm 2 |
| Step | Temperature (°C) | | | | | | | | | | | | | | |
| 1 | 25 \pm 2 | | | | | | | | | | | | | | |
| 2 | Min. Operating Temp. \pm 3 | | | | | | | | | | | | | | |
| 3 | 25 \pm 2 | | | | | | | | | | | | | | |
| 4 | Max. Operating Temp. \pm 2 | | | | | | | | | | | | | | |
| 5 | 25 \pm 2 | | | | | | | | | | | | | | |
| 9 | Adhesive Strength of Termination | No removal of the terminations or other defect should occur. | <p>Solder the capacitor to the testing jig (glass epoxy board) shown in Fig. 1. Then apply 10N force in the direction of the arrow. The soldering should be done using the reflow method and should be conducted with care so that the soldering is uniform and free of defects such as heat shock.</p>  <p>10N (5N : Size 1.6\times0.8mm only), 10\pm1s Glass Epoxy Board</p> <p>Fig. 1</p> | | | | | | | | | | | | |
| 10 | Vibration Resistance | Appearance | No defects or abnormalities | | | | | | | | | | | | |
| | | Capacitance | Within the specified tolerance | | | | | | | | | | | | |
| | D.F. | 0.025 max. | <p>Solder the capacitor to the test jig (glass epoxy board). The capacitor should be subjected to a simple harmonic motion having a total amplitude of 1.5mm, the frequency being varied uniformly between the approximate limits of 10 and 55Hz. The frequency range, from 10 to 55Hz and return to 10Hz, should be traversed in approximately 1 min. This motion should be applied for a period of 2 hrs. in each of 3 mutually perpendicular directions (total of 6 hrs.).</p>  <p>Solder resist Cu Glass Epoxy Board</p> | | | | | | | | | | | | |

* "Room condition" Temperature: 15 to 35°C, Relative humidity: 45 to 75%, Atmospheric pressure: 86 to 106kPa

Continued on the following page. 

GRM Series Specifications and Test Methods

Continued from the preceding page.

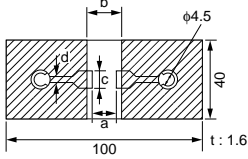
| No. | Item | Specifications | Test Method | | | | | | | | | | | | | | | | | | | | | | | | | | | | | | | |
|----------|------------------------------|--|---|---|----------------|--|--|--|---|---|---|---|---------|-----|-----|-----|-----|----------|-----|-----|------|---------|-----|-----|-----|---------|-----|-----|-----|---------|-----|-----|-----|---------|
| 11 | Deflection | No marking defects | Solder the capacitor to the testing jig (glass epoxy board) shown in Fig. 2. Then apply a force in the direction shown in Fig. 3. The soldering should be done using the reflow method and should be conducted with care so that the soldering is uniform and free of defects such as heat shock. | | | | | | | | | | | | | | | | | | | | | | | | | | | | | | | |
| | |  <p>Fig. 2</p> <table border="1"> <thead> <tr> <th rowspan="2">L×W (mm)</th> <th colspan="4">Dimension (mm)</th> </tr> <tr> <th>a</th> <th>b</th> <th>c</th> <th>d</th> </tr> </thead> <tbody> <tr> <td>1.6×0.8</td> <td>1.0</td> <td>3.0</td> <td>1.2</td> <td rowspan="6">1.0</td> </tr> <tr> <td>2.0×1.25</td> <td>1.2</td> <td>4.0</td> <td>1.65</td> </tr> <tr> <td>3.2×1.6</td> <td>2.2</td> <td>5.0</td> <td>2.0</td> </tr> <tr> <td>3.2×2.5</td> <td>2.2</td> <td>5.0</td> <td>2.9</td> </tr> <tr> <td>4.5×3.2</td> <td>3.5</td> <td>7.0</td> <td>3.7</td> </tr> <tr> <td>5.7×5.0</td> <td>4.5</td> <td>8.0</td> <td>5.6</td> </tr> </tbody> </table> | | L×W (mm) | Dimension (mm) | | | | a | b | c | d | 1.6×0.8 | 1.0 | 3.0 | 1.2 | 1.0 | 2.0×1.25 | 1.2 | 4.0 | 1.65 | 3.2×1.6 | 2.2 | 5.0 | 2.0 | 3.2×2.5 | 2.2 | 5.0 | 2.9 | 4.5×3.2 | 3.5 | 7.0 | 3.7 | 5.7×5.0 |
| L×W (mm) | Dimension (mm) | | | | | | | | | | | | | | | | | | | | | | | | | | | | | | | | | |
| | a | b | c | d | | | | | | | | | | | | | | | | | | | | | | | | | | | | | | |
| 1.6×0.8 | 1.0 | 3.0 | 1.2 | 1.0 | | | | | | | | | | | | | | | | | | | | | | | | | | | | | | |
| 2.0×1.25 | 1.2 | 4.0 | 1.65 | | | | | | | | | | | | | | | | | | | | | | | | | | | | | | | |
| 3.2×1.6 | 2.2 | 5.0 | 2.0 | | | | | | | | | | | | | | | | | | | | | | | | | | | | | | | |
| 3.2×2.5 | 2.2 | 5.0 | 2.9 | | | | | | | | | | | | | | | | | | | | | | | | | | | | | | | |
| 4.5×3.2 | 3.5 | 7.0 | 3.7 | | | | | | | | | | | | | | | | | | | | | | | | | | | | | | | |
| 5.7×5.0 | 4.5 | 8.0 | 5.6 | | | | | | | | | | | | | | | | | | | | | | | | | | | | | | | |
| 12 | Solderability of Termination | 75% of the terminations are to be soldered evenly and continuously. | Immerse the capacitor in a solution of ethanol (JIS-K-8101) and rosin (JIS-K-5902) (25% rosin in weight proportion). Immerse in solder solution for 2±0.5 sec. Immersing speed: 25±2.5mm/s Temp. of solder: 245±5°C Lead Free Solder (Sn-3.0Ag-0.5Cu) 235±5°C H60A or H63A Eutectic Solder | | | | | | | | | | | | | | | | | | | | | | | | | | | | | | | |
| 13 | Resistance to Soldering Heat | Appearance | No marking defects | Preheat the capacitor at 120 to 150°C* for 1 min. Immerse the capacitor in solder solution at 260±5°C for 10±1 sec. Let sit at room condition* for 24±2 hrs., then measure. •Immersing speed: 25±2.5mm/s •Pretreatment Perform a heat treatment at 150±18°C for 60±5 min. and then let sit for 24±2 hrs. at room condition.* *Preheating for more than 3.2×2.5mm | | | | | | | | | | | | | | | | | | | | | | | | | | | | | | |
| | | Capacitance Change | Within ±10% | | | | | | | | | | | | | | | | | | | | | | | | | | | | | | | |
| | | D.F. | 0.025 max. | | | | | | | | | | | | | | | | | | | | | | | | | | | | | | | |
| | | I.R. | C≥0.01μF: More than 100MΩ • μF C<0.01μF: More than 10,000MΩ | | | | | | | | | | | | | | | | | | | | | | | | | | | | | | | |
| | | Dielectric Strength | In accordance with item No.4 | | | | | | | | | | | | | | | | | | | | | | | | | | | | | | | |
| 14 | Temperature Cycle | Appearance | No marking defects | Fix the capacitor to the supporting jig (glass epoxy board) shown in Fig. 4. Perform the 5 cycles according to the 4 heat treatments listed in the following table. Let sit for 24±2 hrs. at room condition,* then measure. | | | | | | | | | | | | | | | | | | | | | | | | | | | | | | |
| | | Capacitance Change | Within ±7.5% | | | | | | | | | | | | | | | | | | | | | | | | | | | | | | | |
| | | D.F. | 0.025 max. | | | | | | | | | | | | | | | | | | | | | | | | | | | | | | | |
| | | I.R. | C≥0.01μF: More than 100MΩ • μF C<0.01μF: More than 10,000MΩ | | | | | | | | | | | | | | | | | | | | | | | | | | | | | | | |
| | | Dielectric Strength | In accordance with item No.4 | | | | | | | | | | | | | | | | | | | | | | | | | | | | | | | |
| 15 | Humidity (Steady State) | Appearance | No marking defects | Let the capacitor sit at 40±2°C and relative humidity of 90 to 95% for 500±24hrs. Remove and let sit for 24±2 hrs. at room condition,* then measure. •Pretreatment Perform a heat treatment at 150±18°C for 60±5 min. and then let sit for 24±2 hrs. at room condition.* | | | | | | | | | | | | | | | | | | | | | | | | | | | | | | |
| | | Capacitance Change | Within ±15% | | | | | | | | | | | | | | | | | | | | | | | | | | | | | | | |
| | | D.F. | 0.05 max. | | | | | | | | | | | | | | | | | | | | | | | | | | | | | | | |
| | | I.R. | C≥0.01μF: More than 10MΩ • μF C<0.01μF: More than 1,000MΩ | | | | | | | | | | | | | | | | | | | | | | | | | | | | | | | |
| | | Dielectric Strength | In accordance with item No.4 | | | | | | | | | | | | | | | | | | | | | | | | | | | | | | | |

* "Room condition" Temperature: 15 to 35°C, Relative humidity: 45 to 75%, Atmospheric pressure: 86 to 106kPa

Continued on the following page. 

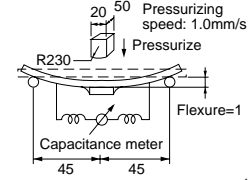

Fig. 3

(in mm)

| Step | Temperature | Time |
|------|--------------|--------|
| 1 | 100 to 120°C | 1 min. |
| 2 | 170 to 200°C | 1 min. |

| Step | Temperature (°C) | Time (min.) |
|------|------------------------|-------------|
| 1 | Min. Operating Temp.±3 | 30±3 |
| 2 | Room Temp. | 2 to 3 |
| 3 | Max. Operating Temp.±2 | 30±3 |
| 4 | Room Temp. | 2 to 3 |

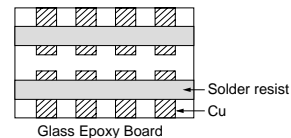

Fig. 4

GRM Series Specifications and Test Methods

Continued from the preceding page.

| No. | Item | Specifications | Test Method |
|-----|--|---------------------|--|
| 16 | Life | Appearance | No marking defects |
| | | Capacitance Change | Within $\pm 15\%$ (rated voltage: DC250V, DC630V) Within $\pm 20\%$ (rated voltage: DC1kV) |
| | | D.F. | 0.05 max. |
| | | I.R. | $C \geq 0.01\mu\text{F}$: More than $10\text{M}\Omega \cdot \mu\text{F}$ $C < 0.01\mu\text{F}$: More than $1,000\text{M}\Omega$ |
| | | Dielectric Strength | In accordance with item No.4 |
| 17 | Humidity Loading (Application: DC250V, DC630V item) | Appearance | No marking defects |
| | | Capacitance Change | Within $\pm 15\%$ |
| | | D.F. | 0.05 max. |
| | | I.R. | $C \geq 0.01\mu\text{F}$: More than $10\text{M}\Omega \cdot \mu\text{F}$ $C < 0.01\mu\text{F}$: More than $1,000\text{M}\Omega$ |
| | | Dielectric Strength | In accordance with item No.4 |

* "Room condition" Temperature: 15 to 35°C, Relative humidity: 45 to 75%, Atmospheric pressure: 86 to 106kPa

Chip Monolithic Ceramic Capacitors (Medium Voltage)



Soft Termination Type GRJ series

■ Features

1. Improves endurance against Board Bending Stress.
2. Reduces the board bending stress by the conductive polymer termination.
3. Use the GRJ21/31 types with flow or reflow soldering, and other types with reflow soldering only.

■ Applications

1. Ideal for use on diode-snubber circuits for switching power supplies.
2. Ideal for use as primary-secondary coupling for DC-DC converters.
3. Ideal for use on line filters and ringer detectors for telephones, facsimiles and modems.

Do not use these products in any Automotive Power train or Safety equipment including Battery chargers for Electric Vehicles and Plug-in Hybrids. Only Murata products clearly stipulated as "for Automotive use" can be used for automobile applications such as Power train and Safety equipment.

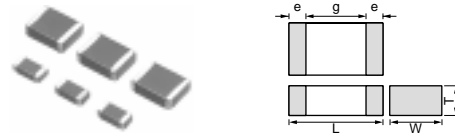

| Part Number | Dimensions (mm) | | | | |
|-------------|-----------------|-----------|--------------|----------|--------|
| | L | W | T | e | g min. |
| GRJ21A | 2.0 ±0.2 | 1.25 ±0.2 | 1.0 +0,-0.3 | 0.3 min. | 0.7 |
| GRJ21B | | | 1.25 ±0.2 | | |
| GRJ31B | 3.2 ±0.2 | 1.6 ±0.2 | 1.25 +0,-0.3 | | 1.2 |
| GRJ31C | | | 1.6 ±0.2 | | |
| GRJ32Q | 3.2 ±0.3 | 2.5 ±0.2 | 1.5 +0,-0.3 | | 2.2 |
| GRJ32D | | | 2.0 +0,-0.3 | | |
| GRJ43Q | 4.5 ±0.4 | 3.2 ±0.3 | 1.5 +0,-0.3 | | 3.2 |
| GRJ43D | | | 2.0 +0,-0.3 | | |
| GRJ55D | 5.7 ±0.4 | 5.0 ±0.4 | 2.0 +0,-0.3 | | |

| Part Number | Rated Voltage (V) | TC Code (Standard) | Capacitance | Length L (mm) | Width W (mm) | Thickness T (mm) | Electrode g min. (mm) | Electrode e (mm) |
|--------------------|-------------------|--------------------|--------------|---------------|--------------|------------------|-----------------------|------------------|
| GRJ21AR72E102KWJ1D | DC250 | X7R (EIA) | 1000pF ±10% | 2.0 | 1.25 | 1.0 | 0.7 | 0.3 min. |
| GRJ21AR72E152KWJ1D | DC250 | X7R (EIA) | 1500pF ±10% | 2.0 | 1.25 | 1.0 | 0.7 | 0.3 min. |
| GRJ21AR72E222KWJ1D | DC250 | X7R (EIA) | 2200pF ±10% | 2.0 | 1.25 | 1.0 | 0.7 | 0.3 min. |
| GRJ21AR72E332KWJ1D | DC250 | X7R (EIA) | 3300pF ±10% | 2.0 | 1.25 | 1.0 | 0.7 | 0.3 min. |
| GRJ21AR72E472KWJ1D | DC250 | X7R (EIA) | 4700pF ±10% | 2.0 | 1.25 | 1.0 | 0.7 | 0.3 min. |
| GRJ21AR72E682KWJ1D | DC250 | X7R (EIA) | 6800pF ±10% | 2.0 | 1.25 | 1.0 | 0.7 | 0.3 min. |
| GRJ21BR72E103KWJ3L | DC250 | X7R (EIA) | 10000pF ±10% | 2.0 | 1.25 | 1.25 | 0.7 | 0.3 min. |
| GRJ31BR72E153KWJ1L | DC250 | X7R (EIA) | 15000pF ±10% | 3.2 | 1.6 | 1.25 | 1.2 | 0.3 min. |
| GRJ31BR72E223KWJ1L | DC250 | X7R (EIA) | 22000pF ±10% | 3.2 | 1.6 | 1.25 | 1.2 | 0.3 min. |
| GRJ31CR72E333KWJ3L | DC250 | X7R (EIA) | 33000pF ±10% | 3.2 | 1.6 | 1.6 | 1.2 | 0.3 min. |
| GRJ31CR72E473KWJ3L | DC250 | X7R (EIA) | 47000pF ±10% | 3.2 | 1.6 | 1.6 | 1.2 | 0.3 min. |
| GRJ31BR72E683KWJ1L | DC250 | X7R (EIA) | 68000pF ±10% | 3.2 | 1.6 | 1.25 | 1.2 | 0.3 min. |
| GRJ32QR72E683KWJ1L | DC250 | X7R (EIA) | 68000pF ±10% | 3.2 | 2.5 | 1.5 | 1.2 | 0.3 min. |
| GRJ31CR72E104KWJ3L | DC250 | X7R (EIA) | 0.10µF ±10% | 3.2 | 1.6 | 1.6 | 1.2 | 0.3 min. |
| GRJ32DR72E104KWJ1L | DC250 | X7R (EIA) | 0.10µF ±10% | 3.2 | 2.5 | 2.0 | 1.2 | 0.3 min. |
| GRJ32QR72E154KWJ1L | DC250 | X7R (EIA) | 0.15µF ±10% | 3.2 | 2.5 | 1.5 | 1.2 | 0.3 min. |
| GRJ43QR72E154KWJ1L | DC250 | X7R (EIA) | 0.15µF ±10% | 4.5 | 3.2 | 1.5 | 2.2 | 0.3 min. |
| GRJ32DR72E224KWJ1L | DC250 | X7R (EIA) | 0.22µF ±10% | 3.2 | 2.5 | 2.0 | 1.2 | 0.3 min. |
| GRJ43DR72E224KWJ1L | DC250 | X7R (EIA) | 0.22µF ±10% | 4.5 | 3.2 | 2.0 | 2.2 | 0.3 min. |
| GRJ43DR72E334KWJ1L | DC250 | X7R (EIA) | 0.33µF ±10% | 4.5 | 3.2 | 2.0 | 2.2 | 0.3 min. |
| GRJ55DR72E334KWJ1L | DC250 | X7R (EIA) | 0.33µF ±10% | 5.7 | 5.0 | 2.0 | 3.2 | 0.3 min. |
| GRJ43DR72E474KWJ1L | DC250 | X7R (EIA) | 0.47µF ±10% | 4.5 | 3.2 | 2.0 | 2.2 | 0.3 min. |
| GRJ55DR72E474KWJ1L | DC250 | X7R (EIA) | 0.47µF ±10% | 5.7 | 5.0 | 2.0 | 3.2 | 0.3 min. |
| GRJ55DR72E105KWJ1L | DC250 | X7R (EIA) | 1.0µF ±10% | 5.7 | 5.0 | 2.0 | 3.2 | 0.3 min. |
| GRJ31BR72J102KWJ1L | DC630 | X7R (EIA) | 1000pF ±10% | 3.2 | 1.6 | 1.25 | 1.2 | 0.3 min. |
| GRJ31BR72J152KWJ1L | DC630 | X7R (EIA) | 1500pF ±10% | 3.2 | 1.6 | 1.25 | 1.2 | 0.3 min. |
| GRJ31BR72J222KWJ1L | DC630 | X7R (EIA) | 2200pF ±10% | 3.2 | 1.6 | 1.25 | 1.2 | 0.3 min. |

Continued on the following page.

Continued from the preceding page.

| Part Number | Rated Voltage (V) | TC Code (Standard) | Capacitance | Length L (mm) | Width W (mm) | Thickness T (mm) | Electrode g min. (mm) | Electrode e (mm) |
|--------------------|-------------------|--------------------|--------------|---------------|--------------|------------------|-----------------------|------------------|
| GRJ31BR72J332KWJ1L | DC630 | X7R (EIA) | 3300pF ±10% | 3.2 | 1.6 | 1.25 | 1.2 | 0.3 min. |
| GRJ31BR72J472KWJ1L | DC630 | X7R (EIA) | 4700pF ±10% | 3.2 | 1.6 | 1.25 | 1.2 | 0.3 min. |
| GRJ31BR72J682KWJ1L | DC630 | X7R (EIA) | 6800pF ±10% | 3.2 | 1.6 | 1.25 | 1.2 | 0.3 min. |
| GRJ31BR72J103KWJ1L | DC630 | X7R (EIA) | 10000pF ±10% | 3.2 | 1.6 | 1.25 | 1.2 | 0.3 min. |
| GRJ31CR72J153KWJ3L | DC630 | X7R (EIA) | 15000pF ±10% | 3.2 | 1.6 | 1.6 | 1.2 | 0.3 min. |
| GRJ32QR72J223KWJ1L | DC630 | X7R (EIA) | 22000pF ±10% | 3.2 | 2.5 | 1.5 | 1.2 | 0.3 min. |
| GRJ32DR72J333KWJ1L | DC630 | X7R (EIA) | 33000pF ±10% | 3.2 | 2.5 | 2.0 | 1.2 | 0.3 min. |
| GRJ32DR72J473KWJ1L | DC630 | X7R (EIA) | 47000pF ±10% | 3.2 | 2.5 | 2.0 | 1.2 | 0.3 min. |
| GRJ43QR72J683KWJ1L | DC630 | X7R (EIA) | 68000pF ±10% | 4.5 | 3.2 | 1.5 | 2.2 | 0.3 min. |
| GRJ43DR72J104KWJ1L | DC630 | X7R (EIA) | 0.10μF ±10% | 4.5 | 3.2 | 2.0 | 2.2 | 0.3 min. |
| GRJ55DR72J154KWJ1L | DC630 | X7R (EIA) | 0.15μF ±10% | 5.7 | 5.0 | 2.0 | 3.2 | 0.3 min. |
| GRJ55DR72J224KWJ1L | DC630 | X7R (EIA) | 0.22μF ±10% | 5.7 | 5.0 | 2.0 | 3.2 | 0.3 min. |
| GRJ31BR73A471KWJ1L | DC1000 | X7R (EIA) | 470pF ±10% | 3.2 | 1.6 | 1.25 | 1.2 | 0.3 min. |
| GRJ31BR73A102KWJ1L | DC1000 | X7R (EIA) | 1000pF ±10% | 3.2 | 1.6 | 1.25 | 1.2 | 0.3 min. |
| GRJ31BR73A152KWJ1L | DC1000 | X7R (EIA) | 1500pF ±10% | 3.2 | 1.6 | 1.25 | 1.2 | 0.3 min. |
| GRJ31BR73A222KWJ1L | DC1000 | X7R (EIA) | 2200pF ±10% | 3.2 | 1.6 | 1.25 | 1.2 | 0.3 min. |
| GRJ31BR73A332KWJ1L | DC1000 | X7R (EIA) | 3300pF ±10% | 3.2 | 1.6 | 1.25 | 1.2 | 0.3 min. |
| GRJ31BR73A472KWJ1L | DC1000 | X7R (EIA) | 4700pF ±10% | 3.2 | 1.6 | 1.25 | 1.2 | 0.3 min. |
| GRJ32QR73A682KWJ1L | DC1000 | X7R (EIA) | 6800pF ±10% | 3.2 | 2.5 | 1.5 | 1.2 | 0.3 min. |
| GRJ32QR73A103KWJ1L | DC1000 | X7R (EIA) | 10000pF ±10% | 3.2 | 2.5 | 1.5 | 1.2 | 0.3 min. |
| GRJ32DR73A153KWJ1L | DC1000 | X7R (EIA) | 15000pF ±10% | 3.2 | 2.5 | 2.0 | 1.2 | 0.3 min. |
| GRJ32DR73A223KWJ1L | DC1000 | X7R (EIA) | 22000pF ±10% | 3.2 | 2.5 | 2.0 | 1.2 | 0.3 min. |
| GRJ43DR73A333KWJ1L | DC1000 | X7R (EIA) | 33000pF ±10% | 4.5 | 3.2 | 2.0 | 2.2 | 0.3 min. |
| GRJ43DR73A473KWJ1L | DC1000 | X7R (EIA) | 47000pF ±10% | 4.5 | 3.2 | 2.0 | 2.2 | 0.3 min. |
| GRJ55DR73A104KWJ1L | DC1000 | X7R (EIA) | 0.10μF ±10% | 5.7 | 5.0 | 2.0 | 3.2 | 0.3 min. |

For General Purpose
GRM/GRJ Series

Only for Applications

AC250V Type
GA2 Series

Safety Standard
Certified GA3 Series

Product Information

GRJ Series Specifications and Test Methods

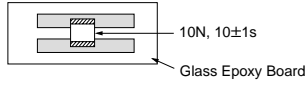
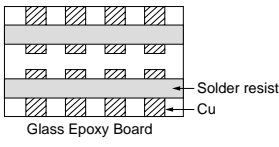
| No. | Item | Specifications | Test Method | | | | | | | | | | | | |
|---------------|---|--|--|---------------|------------------|--------|---------------------------|--------|---------------------------|-------|---------------------------|---|------------------------|---|------|
| 1 | Operating Temperature Range | -55 to +125°C | - | | | | | | | | | | | | |
| 2 | Appearance | No defects or abnormalities | Visual inspection | | | | | | | | | | | | |
| 3 | Dimensions | Within the specified dimensions | Using calipers and micrometers | | | | | | | | | | | | |
| 4 | Dielectric Strength | No defects or abnormalities | <p>No failure should be observed when voltage in the Table is applied between the terminations for 1 to 5 sec., provided the charge/discharge current is less than 50mA.</p> <table border="1" style="margin-left: auto; margin-right: auto;"> <thead> <tr> <th>Rated Voltage</th> <th>Test Voltage</th> </tr> </thead> <tbody> <tr> <td>DC250V</td> <td>200% of the rated voltage</td> </tr> <tr> <td>DC630V</td> <td>150% of the rated voltage</td> </tr> <tr> <td>DC1kV</td> <td>120% of the rated voltage</td> </tr> </tbody> </table> | Rated Voltage | Test Voltage | DC250V | 200% of the rated voltage | DC630V | 150% of the rated voltage | DC1kV | 120% of the rated voltage | | | | |
| Rated Voltage | Test Voltage | | | | | | | | | | | | | | |
| DC250V | 200% of the rated voltage | | | | | | | | | | | | | | |
| DC630V | 150% of the rated voltage | | | | | | | | | | | | | | |
| DC1kV | 120% of the rated voltage | | | | | | | | | | | | | | |
| 5 | Insulation Resistance (I.R.) | C ≥ 0.01μF: More than 100MΩ • μF C < 0.01μF: More than 10,000MΩ | The insulation resistance should be measured with DC500±50V (DC250±25V in case of rated voltage: DC250V) and within 60±5 sec. of charging. | | | | | | | | | | | | |
| 6 | Capacitance | Within the specified tolerance | The capacitance/D.F. should be measured at a frequency of 1±0.2kHz and a voltage of AC1±0.2V(r.m.s.) | | | | | | | | | | | | |
| 7 | Dissipation Factor (D.F.) | 0.025 max. | | | | | | | | | | | | | |
| 8 | Capacitance Temperature Characteristics | Cap. Change Within ±15% (Temp. Range: -55 to +125°C) | <p>The capacitance measurement should be made at each step specified in the Table.</p> <table border="1" style="margin-left: auto; margin-right: auto;"> <thead> <tr> <th>Step</th> <th>Temperature (°C)</th> </tr> </thead> <tbody> <tr> <td>1</td> <td>25±2</td> </tr> <tr> <td>2</td> <td>Min. Operating Temp.±3</td> </tr> <tr> <td>3</td> <td>25±2</td> </tr> <tr> <td>4</td> <td>Max. Operating Temp.±2</td> </tr> <tr> <td>5</td> <td>25±2</td> </tr> </tbody> </table> <p>•Pretreatment Perform a heat treatment at 150±5°C for 60±5 min. and then let sit for 24±2 hrs. at room condition.*</p> | Step | Temperature (°C) | 1 | 25±2 | 2 | Min. Operating Temp.±3 | 3 | 25±2 | 4 | Max. Operating Temp.±2 | 5 | 25±2 |
| Step | Temperature (°C) | | | | | | | | | | | | | | |
| 1 | 25±2 | | | | | | | | | | | | | | |
| 2 | Min. Operating Temp.±3 | | | | | | | | | | | | | | |
| 3 | 25±2 | | | | | | | | | | | | | | |
| 4 | Max. Operating Temp.±2 | | | | | | | | | | | | | | |
| 5 | 25±2 | | | | | | | | | | | | | | |
| 9 | Adhesive Strength of Termination | No removal of the terminations or other defect should occur. | <p>Solder the capacitor to the testing jig (glass epoxy board) shown in Fig. 1. Then apply 10N force in the direction of the arrow. The soldering should be done using the reflow method and should be conducted with care so that the soldering is uniform and free of defects such as heat shock.</p>  <p style="text-align: center;">Fig. 1</p> | | | | | | | | | | | | |
| 10 | Vibration Resistance | Appearance | No defects or abnormalities | | | | | | | | | | | | |
| | | Capacitance | Within the specified tolerance | | | | | | | | | | | | |
| | D.F. | 0.025 max. | <p>Solder the capacitor to the test jig (glass epoxy board). The capacitor should be subjected to a simple harmonic motion having a total amplitude of 1.5mm, the frequency being varied uniformly between the approximate limits of 10 and 55Hz. The frequency range, from 10 to 55Hz and return to 10Hz, should be traversed in approximately 1 min. This motion should be applied for a period of 2 hrs. in each of 3 mutually perpendicular directions (total of 6 hrs.).</p>  | | | | | | | | | | | | |

* "Room condition" Temperature: 15 to 35°C, Relative humidity: 45 to 75%, Atmospheric pressure: 86 to 106kPa

Continued on the following page.

For General Purpose GRM/GRJ Series

Only for Applications

AC250V Type GA2 Series

Safety Standard Certified GA3 Series

Product Information

GRJ Series Specifications and Test Methods

Continued from the preceding page.

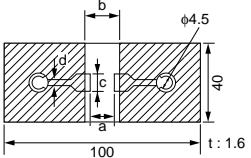
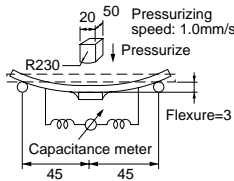
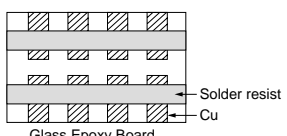
| No. | Item | Specifications | Test Method | | | | | | | | | | | | | | | | | | | | | | | | | | | | | | |
|---------|------------------------------|---|--|----------------|----------------------------------|------------------------------|--|---|---|---|----------------------------|----------|-----|------------------------------|-----------|-----|------------|--------|-----|-----|---------|-----|-----|-----|---------|-----|-----|-----|---------|-----|-----|-----|---|
| 11 | Appearance | No marking defects | Solder the capacitor to the testing jig (glass epoxy board) shown in Fig. 2. Then apply a force in the direction shown in Fig. 3. The soldering should be done using the reflow method and should be conducted with care so that the soldering is uniform and free of defects such as heat shock. | | | | | | | | | | | | | | | | | | | | | | | | | | | | | | |
| | Capacitance Change | Within $\pm 12.5\%$ | | | | | | | | | | | | | | | | | | | | | | | | | | | | | | | |
| 11 | Deflection |  <p>Fig. 2</p> <table border="1"> <thead> <tr> <th rowspan="2">L×W (mm)</th> <th colspan="4">Dimension (mm)</th> </tr> <tr> <th>a</th> <th>b</th> <th>c</th> <th>d</th> </tr> </thead> <tbody> <tr> <td>2.0×1.25</td> <td>1.2</td> <td>4.0</td> <td>1.65</td> <td rowspan="6">1.0</td> </tr> <tr> <td>3.2×1.6</td> <td>2.2</td> <td>5.0</td> <td>2.0</td> </tr> <tr> <td>3.2×2.5</td> <td>2.2</td> <td>5.0</td> <td>2.9</td> </tr> <tr> <td>4.5×3.2</td> <td>3.5</td> <td>7.0</td> <td>3.7</td> </tr> <tr> <td>5.7×5.0</td> <td>4.5</td> <td>8.0</td> <td>5.6</td> </tr> </tbody> </table> | L×W (mm) | Dimension (mm) | | | | a | b | c | d | 2.0×1.25 | 1.2 | 4.0 | 1.65 | 1.0 | 3.2×1.6 | 2.2 | 5.0 | 2.0 | 3.2×2.5 | 2.2 | 5.0 | 2.9 | 4.5×3.2 | 3.5 | 7.0 | 3.7 | 5.7×5.0 | 4.5 | 8.0 | 5.6 |  <p>Fig. 3 (in mm)</p> |
| | | | | L×W (mm) | Dimension (mm) | | | | | | | | | | | | | | | | | | | | | | | | | | | | |
| | | | a | | b | c | d | | | | | | | | | | | | | | | | | | | | | | | | | | |
| | | | 2.0×1.25 | 1.2 | 4.0 | 1.65 | 1.0 | | | | | | | | | | | | | | | | | | | | | | | | | | |
| | | | 3.2×1.6 | 2.2 | 5.0 | 2.0 | | | | | | | | | | | | | | | | | | | | | | | | | | | |
| | | | 3.2×2.5 | 2.2 | 5.0 | 2.9 | | | | | | | | | | | | | | | | | | | | | | | | | | | |
| 4.5×3.2 | 3.5 | 7.0 | 3.7 | | | | | | | | | | | | | | | | | | | | | | | | | | | | | | |
| 5.7×5.0 | 4.5 | 8.0 | 5.6 | | | | | | | | | | | | | | | | | | | | | | | | | | | | | | |
| 12 | Solderability of Termination | 75% of the terminations are to be soldered evenly and continuously. | Immerse the capacitor in a solution of ethanol (JIS-K-8101) and rosin (JIS-K-5902) (25% rosin in weight proportion). Immerse in solder solution for 2 ± 0.5 sec. Immersing speed: 25 ± 2.5 mm/s Temp. of solder: $245\pm 5^\circ\text{C}$ Lead Free Solder (Sn-3.0Ag-0.5Cu) $235\pm 5^\circ\text{C}$ H60A or H63A Eutectic Solder | | | | | | | | | | | | | | | | | | | | | | | | | | | | | | |
| | | | | 13 | Resistance to Soldering Heat | Appearance | No marking defects | Preheat the capacitor at 120 to 150°C^* for 1 min. Immerse the capacitor in solder solution at $260\pm 5^\circ\text{C}$ for 10 ± 1 sec. Let sit at room condition* for 24 ± 2 hrs., then measure. •Immersing speed: 25 ± 2.5 mm/s •Pretreatment Perform a heat treatment at $150\pm 1^\circ\text{C}$ for 60 ± 5 min. and then let sit for 24 ± 2 hrs. at room condition.* | | | | | | | | | | | | | | | | | | | | | | | | | |
| | | | | | | Capacitance Change | Within $\pm 10\%$ | | | | | | | | | | | | | | | | | | | | | | | | | | |
| | | | | | | D.F. | 0.025 max. | | | | | | | | | | | | | | | | | | | | | | | | | | |
| | | | | | | I.R. | $C\geq 0.01\mu\text{F}$: More than $100\text{M}\Omega \cdot \mu\text{F}$ $C< 0.01\mu\text{F}$: More than $10,000\text{M}\Omega$ | | | | | | | | | | | | | | | | | | | | | | | | | | |
| 13 | Dielectric Strength | In accordance with item No.4 | <table border="1"> <thead> <tr> <th>Step</th> <th>Temperature</th> <th>Time</th> </tr> </thead> <tbody> <tr> <td>1</td> <td>100 to 120°C</td> <td>1 min.</td> </tr> <tr> <td>2</td> <td>170 to 200°C</td> <td>1 min.</td> </tr> </tbody> </table> | Step | Temperature | Time | 1 | 100 to 120°C | 1 min. | 2 | 170 to 200°C | 1 min. | | | | | | | | | | | | | | | | | | | | | |
| | | | | Step | Temperature | Time | | | | | | | | | | | | | | | | | | | | | | | | | | | |
| 1 | 100 to 120°C | 1 min. | | | | | | | | | | | | | | | | | | | | | | | | | | | | | | | |
| 2 | 170 to 200°C | 1 min. | | | | | | | | | | | | | | | | | | | | | | | | | | | | | | | |
| 14 | Temperature Cycle | In accordance with item No.4 | <table border="1"> <thead> <tr> <th>Step</th> <th>Temperature ($^\circ\text{C}$)</th> <th>Time (min.)</th> </tr> </thead> <tbody> <tr> <td>1</td> <td>Min. Operating Temp. ± 3</td> <td>30 ± 3</td> </tr> <tr> <td>2</td> <td>Room Temp.</td> <td>2 to 3</td> </tr> <tr> <td>3</td> <td>Max. Operating Temp. ± 2</td> <td>30 ± 3</td> </tr> <tr> <td>4</td> <td>Room Temp.</td> <td>2 to 3</td> </tr> </tbody> </table> | Step | Temperature ($^\circ\text{C}$) | Time (min.) | 1 | Min. Operating Temp. ± 3 | 30 ± 3 | 2 | Room Temp. | 2 to 3 | 3 | Max. Operating Temp. ± 2 | 30 ± 3 | 4 | Room Temp. | 2 to 3 | | | | | | | | | | | | | | | |
| | | | | Step | Temperature ($^\circ\text{C}$) | Time (min.) | | | | | | | | | | | | | | | | | | | | | | | | | | | |
| | | | | 1 | Min. Operating Temp. ± 3 | 30 ± 3 | | | | | | | | | | | | | | | | | | | | | | | | | | | |
| | | | | 2 | Room Temp. | 2 to 3 | | | | | | | | | | | | | | | | | | | | | | | | | | | |
| | | | | 3 | Max. Operating Temp. ± 2 | 30 ± 3 | | | | | | | | | | | | | | | | | | | | | | | | | | | |
| 4 | Room Temp. | 2 to 3 | | | | | | | | | | | | | | | | | | | | | | | | | | | | | | | |
| 14 | Dielectric Strength | In accordance with item No.4 | <p>•Pretreatment Perform a heat treatment at $150\pm 1^\circ\text{C}$ for 60 ± 5 min. and then let sit for 24 ± 2 hrs. at room condition.*</p>  <p>Fig. 4</p> | | | | | | | | | | | | | | | | | | | | | | | | | | | | | | |
| | | | | 15 | Humidity (Steady State) | In accordance with item No.4 | Appearance | No marking defects | Let the capacitor sit at $40\pm 2^\circ\text{C}$ and relative humidity of 90 to 95% for 500 ± 2 hrs. Remove and let sit for 24 ± 2 hrs. at room condition,* then measure. •Pretreatment Perform a heat treatment at $150\pm 1^\circ\text{C}$ for 60 ± 5 min. and then let sit for 24 ± 2 hrs. at room condition.* | | | | | | | | | | | | | | | | | | | | | | | | |
| | | | | | | | Capacitance Change | Within $\pm 15\%$ | | | | | | | | | | | | | | | | | | | | | | | | | |
| | | | | | | | D.F. | 0.05 max. | | | | | | | | | | | | | | | | | | | | | | | | | |
| | | | | | | | I.R. | $C\geq 0.01\mu\text{F}$: More than $10\text{M}\Omega \cdot \mu\text{F}$ $C< 0.01\mu\text{F}$: More than $1,000\text{M}\Omega$ | | | | | | | | | | | | | | | | | | | | | | | | | |

* "Room condition" Temperature: 15 to 35°C , Relative humidity: 45 to 75%, Atmospheric pressure: 86 to 106kPa

Continued on the following page. 

GRJ Series Specifications and Test Methods

☐ Continued from the preceding page.

| No. | Item | Specifications | Test Method | | | | | | | | |
|---------------|--|---------------------|--|---------------|-----------------|--------|---------------------------|--------|---------------------------|-------|---------------------------|
| 16 | Life | Appearance | No marking defects | | | | | | | | |
| | | Capacitance Change | Within ±15% (rated voltage: DC250V, DC630V) Within ±20% (rated voltage: DC1kV) | | | | | | | | |
| | | D.F. | 0.05 max. | | | | | | | | |
| | | I.R. | C≥0.01μF: More than 10MΩ • μF C<0.01μF: More than 1,000MΩ | | | | | | | | |
| | | Dielectric Strength | In accordance with item No.4 | | | | | | | | |
| | | | <table border="1" style="width: 100%;"> <thead> <tr> <th style="text-align: center;">Rated Voltage</th> <th style="text-align: center;">Applied Voltage</th> </tr> </thead> <tbody> <tr> <td style="text-align: center;">DC250V</td> <td style="text-align: center;">150% of the rated voltage</td> </tr> <tr> <td style="text-align: center;">DC630V</td> <td style="text-align: center;">120% of the rated voltage</td> </tr> <tr> <td style="text-align: center;">DC1kV</td> <td style="text-align: center;">110% of the rated voltage</td> </tr> </tbody> </table> | Rated Voltage | Applied Voltage | DC250V | 150% of the rated voltage | DC630V | 120% of the rated voltage | DC1kV | 110% of the rated voltage |
| Rated Voltage | Applied Voltage | | | | | | | | | | |
| DC250V | 150% of the rated voltage | | | | | | | | | | |
| DC630V | 120% of the rated voltage | | | | | | | | | | |
| DC1kV | 110% of the rated voltage | | | | | | | | | | |
| | | | The charge/discharge current is less than 50mA. •Pretreatment Apply test voltage for 60±5 min. at test temperature. Remove and let sit for 24±2 hrs. at room condition.* | | | | | | | | |
| 17 | Humidity Loading (Application: DC250V, DC630V item) | Appearance | No marking defects | | | | | | | | |
| | | Capacitance Change | Within ±15% | | | | | | | | |
| | | D.F. | 0.05 max. | | | | | | | | |
| | | I.R. | C≥0.01μF: More than 10MΩ • μF C<0.01μF: More than 1,000MΩ | | | | | | | | |
| | | Dielectric Strength | In accordance with item No.4 | | | | | | | | |
| | | | Apply the rated voltage at 40±2°C and relative humidity of 90 to 95% for 500±2hrs. Remove and let sit for 24±2 hrs. at room condition,* then measure. •Pretreatment Apply test voltage for 60±5 min. at test temperature. Remove and let sit for 24±2 hrs. at room condition.* | | | | | | | | |

* "Room condition" Temperature: 15 to 35°C, Relative humidity: 45 to 75%, Atmospheric pressure: 86 to 106kPa

For General Purpose
GRM/GRJ Series

Only for Applications

AC250V Type
GA2 Series

Safety Standard
Certified GA3 Series

Product Information

For General Purpose
GRM/GRJ Series

Only for Applications
GRM/DC3.15kV Series

AC250V Type
GA2 Series

Safety Standard
Certified GA3 Series

Product Information

Chip Monolithic Ceramic Capacitors (Medium Voltage)



For LCD Backlight Inverter Circuit GRM/DC3.15kV Series

■ Features

1. Low-loss and suitable for high frequency circuits
2. Murata's original internal electrode structure realizes high flash-over voltage.
3. A new monolithic structure for small, surface-mountable devices capable of operating at high voltage levels.
4. Sn-plated external electrodes realize good solderability.
5. Only for reflow soldering
6. Capacitance values less than 22pF can be used in LCD backlight inverter circuits as long as the applied voltage, peak to peak, is less than 4.0kV at 100kHz or less.

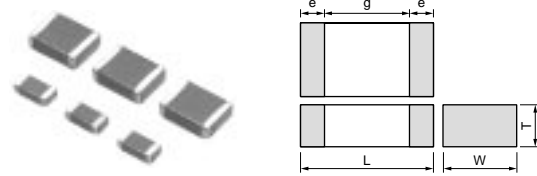

| Part Number | Dimensions (mm) | | | | |
|---------------|-----------------|----------|--------------|--------|--------|
| | L | W | T | e min. | g min. |
| GRM42A | 4.5 ±0.3 | 2.0 ±0.2 | 1.0 +0, -0.3 | 0.3 | 2.9 |

■ Applications

Ideal for use as the ballast in LCD backlight inverter.

Do not use these products in any Automotive Power train or Safety equipment including Battery chargers for Electric Vehicles and Plug-in Hybrids. Only Murata products clearly stipulated as "for Automotive use" can be used for automobile applications such as Power train and Safety equipment.

| Part Number | Rated Voltage (V) | TC Code (Standard) | Capacitance (pF) | Length L (mm) | Width W (mm) | Thickness T (mm) | Electrode g min. (mm) | Electrode e (mm) |
|---------------------------|-------------------|--------------------|------------------|---------------|--------------|------------------|-----------------------|------------------|
| GRM42A5C3F050DW01L | DC3150 | COG (EIA) | 5.0 ±0.5pF | 4.5 | 2.0 | 1.0 | 2.9 | 0.3 min. |
| GRM42A5C3F100JW01L | DC3150 | COG (EIA) | 10 ±5% | 4.5 | 2.0 | 1.0 | 2.9 | 0.3 min. |
| GRM42A5C3F120JW01L | DC3150 | COG (EIA) | 12 ±5% | 4.5 | 2.0 | 1.0 | 2.9 | 0.3 min. |
| GRM42A5C3F150JW01L | DC3150 | COG (EIA) | 15 ±5% | 4.5 | 2.0 | 1.0 | 2.9 | 0.3 min. |
| GRM42A5C3F180JW01L | DC3150 | COG (EIA) | 18 ±5% | 4.5 | 2.0 | 1.0 | 2.9 | 0.3 min. |
| GRM42A5C3F220JW01L | DC3150 | COG (EIA) | 22 ±5% | 4.5 | 2.0 | 1.0 | 2.9 | 0.3 min. |
| GRM42A5C3F270JW01L | DC3150 | COG (EIA) | 27 ±5% | 4.5 | 2.0 | 1.0 | 2.9 | 0.3 min. |
| GRM42A5C3F330JW01L | DC3150 | COG (EIA) | 33 ±5% | 4.5 | 2.0 | 1.0 | 2.9 | 0.3 min. |
| GRM42A5C3F390JW01L | DC3150 | COG (EIA) | 39 ±5% | 4.5 | 2.0 | 1.0 | 2.9 | 0.3 min. |
| GRM42A5C3F470JW01L | DC3150 | COG (EIA) | 47 ±5% | 4.5 | 2.0 | 1.0 | 2.9 | 0.3 min. |

GRM/DC3.15kV Series Specifications and Test Methods

For General Purpose
GRM/GRJ Series

Only for Applications
GRM/DC3.15kV Series

AC250V Type
GA2 Series

Safety Standard
Certified GA3 Series

Product Information

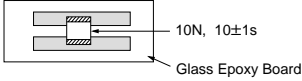
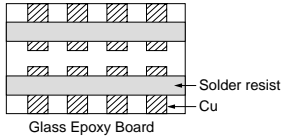
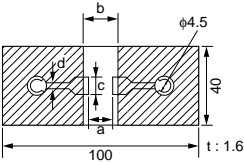
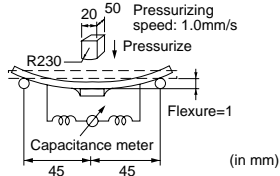
| No. | Item | Specifications | Test Method | | | | | | | | | | | | | | |
|----------|---|---|---|----------|------------------|---|------|---|------------------------|---|------|---|------------------------|-----|------|-----|-----|
| 1 | Operating Temperature Range | -55 to +125°C | - | | | | | | | | | | | | | | |
| 2 | Appearance | No defects or abnormalities | Visual inspection | | | | | | | | | | | | | | |
| 3 | Dimensions | Within the specified dimension | Using calipers and micrometers | | | | | | | | | | | | | | |
| 4 | Dielectric Strength | No defects or abnormalities | No failure should be observed when DC4095V is applied between the terminations for 1 to 5 sec., provided the charge/discharge current is less than 50mA. | | | | | | | | | | | | | | |
| 5 | Insulation Resistance (I.R.) | More than 10,000MΩ | The insulation resistance should be measured with DC500±50V and within 60±5 sec. of charging. | | | | | | | | | | | | | | |
| 6 | Capacitance | Within the specified tolerance | The capacitance/Q should be measured at a frequency of 1±0.2MHz and a voltage of AC0.5 to 5V(r.m.s.) | | | | | | | | | | | | | | |
| 7 | Q | 1,000 min. | | | | | | | | | | | | | | | |
| 8 | Capacitance Temperature Characteristics | Temp. Coefficient 0±30ppm/°C (Temp. Range: +25 to +125°C) 0+30, -72ppm/°C (Temp. Range: -55 to +25°C) | The capacitance measurement should be made at each step specified in the Table. | | | | | | | | | | | | | | |
| | | | <table border="1" style="width: 100%;"> <thead> <tr> <th>Step</th> <th>Temperature (°C)</th> </tr> </thead> <tbody> <tr> <td>1</td> <td>25±2</td> </tr> <tr> <td>2</td> <td>Min. Operating Temp.±3</td> </tr> <tr> <td>3</td> <td>25±2</td> </tr> <tr> <td>4</td> <td>Max. Operating Temp.±2</td> </tr> <tr> <td>5</td> <td>25±2</td> </tr> </tbody> </table> | Step | Temperature (°C) | 1 | 25±2 | 2 | Min. Operating Temp.±3 | 3 | 25±2 | 4 | Max. Operating Temp.±2 | 5 | 25±2 | | |
| Step | Temperature (°C) | | | | | | | | | | | | | | | | |
| 1 | 25±2 | | | | | | | | | | | | | | | | |
| 2 | Min. Operating Temp.±3 | | | | | | | | | | | | | | | | |
| 3 | 25±2 | | | | | | | | | | | | | | | | |
| 4 | Max. Operating Temp.±2 | | | | | | | | | | | | | | | | |
| 5 | 25±2 | | | | | | | | | | | | | | | | |
| 9 | Adhesive Strength of Termination | No removal of the terminations or other defect should occur. | <p>Solder the capacitor to the testing jig (glass epoxy board) shown in Fig. 1. Then apply 10N force in the direction of the arrow. The soldering should be done using the reflow method and should be conducted with care so that the soldering is uniform and free of defects such as heat shock.</p>  <p style="text-align: center;">Fig. 1</p> | | | | | | | | | | | | | | |
| 10 | Vibration Resistance | Appearance | No defects or abnormalities | | | | | | | | | | | | | | |
| | | Capacitance | Within the specified tolerance | | | | | | | | | | | | | | |
| | Q | 1,000 min. | <p>Solder the capacitor to the test jig (glass epoxy board). The capacitor should be subjected to a simple harmonic motion having a total amplitude of 1.5mm, the frequency being varied uniformly between the approximate limits of 10 and 55Hz. The frequency range, from 10 to 55Hz and return to 10Hz, should be traversed in approximately 1 min. This motion should be applied for a period of 2 hrs. in each of 3 mutually perpendicular directions (total of 6 hrs.).</p>  | | | | | | | | | | | | | | |
| 11 | Deflection | No marking defects | <p>Solder the capacitor to the testing jig (glass epoxy board) shown in Fig. 2. Then apply a force in the direction shown in Fig. 3. The soldering should be done using the reflow method and should be conducted with care so that the soldering is uniform and free of defects such as heat shock.</p>  <p style="text-align: center;">Fig. 2</p> <table border="1" style="width: 100%; text-align: center;"> <thead> <tr> <th rowspan="2">L×W (mm)</th> <th colspan="4">Dimension (mm)</th> </tr> <tr> <th>a</th> <th>b</th> <th>c</th> <th>d</th> </tr> </thead> <tbody> <tr> <td>4.5×2.0</td> <td>3.5</td> <td>7.0</td> <td>2.4</td> <td>1.0</td> </tr> </tbody> </table>  <p style="text-align: center;">Fig. 3</p> | L×W (mm) | Dimension (mm) | | | | a | b | c | d | 4.5×2.0 | 3.5 | 7.0 | 2.4 | 1.0 |
| L×W (mm) | Dimension (mm) | | | | | | | | | | | | | | | | |
| | a | b | c | d | | | | | | | | | | | | | |
| 4.5×2.0 | 3.5 | 7.0 | 2.4 | 1.0 | | | | | | | | | | | | | |

Continued on the following page.

GRM/DC3.15kV Series Specifications and Test Methods

Continued from the preceding page.

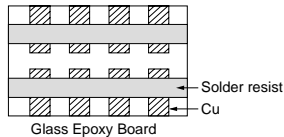
| No. | Item | Specifications | Test Method | | | | | | | | | | | | | | | |
|------|------------------------------|---|---|------|------------------|-------------|---|------------------------|--------|---|--------------|--------|---|------------------------|------|---|------------|--------|
| 12 | Solderability of Termination | 75% of the terminations are to be soldered evenly and continuously. | Immerse the capacitor in a solution of ethanol (JIS-K-8101) and rosin (JIS-K-5902) (25% rosin in weight proportion). Immerse in solder solution for 2±0.5 sec. Immersing speed: 25±2.5mm/s Temp. of solder: 245±5°C Lead Free Solder (Sn-3.0Ag-0.5Cu) 235±5°C H60A or H63A Eutectic Solder | | | | | | | | | | | | | | | |
| 13 | Resistance to Soldering Heat | Appearance | No marking defects | | | | | | | | | | | | | | | |
| | | Capacitance Change | Within ±2.5% | | | | | | | | | | | | | | | |
| | | Q | 1,000 min. | | | | | | | | | | | | | | | |
| | | I.R. | More than 10,000MΩ | | | | | | | | | | | | | | | |
| | | Dielectric Strength | In accordance with item No.4 | | | | | | | | | | | | | | | |
| | | | Preheat the capacitor as in table. Immerse the capacitor in solder solution at 260±5°C for 10±1 sec. Let sit at room condition* for 24±2 hrs., then measure. •Immersing speed: 25±2.5mm/s | | | | | | | | | | | | | | | |
| | | | *Preheating | | | | | | | | | | | | | | | |
| | | | <table border="1"> <thead> <tr> <th>Step</th> <th>Temperature</th> <th>Time</th> </tr> </thead> <tbody> <tr> <td>1</td> <td>100 to 120°C</td> <td>1 min.</td> </tr> <tr> <td>2</td> <td>170 to 200°C</td> <td>1 min.</td> </tr> </tbody> </table> | Step | Temperature | Time | 1 | 100 to 120°C | 1 min. | 2 | 170 to 200°C | 1 min. | | | | | | |
| Step | Temperature | Time | | | | | | | | | | | | | | | | |
| 1 | 100 to 120°C | 1 min. | | | | | | | | | | | | | | | | |
| 2 | 170 to 200°C | 1 min. | | | | | | | | | | | | | | | | |
| 14 | Temperature Cycle | Appearance | No marking defects | | | | | | | | | | | | | | | |
| | | Capacitance Change | Within ±2.5% | | | | | | | | | | | | | | | |
| | | Q | 1,000 min. | | | | | | | | | | | | | | | |
| | | I.R. | More than 10,000MΩ | | | | | | | | | | | | | | | |
| | | Dielectric Strength | In accordance with item No.4 | | | | | | | | | | | | | | | |
| | | | Fix the capacitor to the supporting jig (glass epoxy board) shown in Fig. 4. Perform the 5 cycles according to the 4 heat treatments listed in the following table. Let sit for 24±2 hrs. at room condition,* then measure. | | | | | | | | | | | | | | | |
| | | | <table border="1"> <thead> <tr> <th>Step</th> <th>Temperature (°C)</th> <th>Time (min.)</th> </tr> </thead> <tbody> <tr> <td>1</td> <td>Min. Operating Temp.±3</td> <td>30±3</td> </tr> <tr> <td>2</td> <td>Room Temp.</td> <td>2 to 3</td> </tr> <tr> <td>3</td> <td>Max. Operating Temp.±2</td> <td>30±3</td> </tr> <tr> <td>4</td> <td>Room Temp.</td> <td>2 to 3</td> </tr> </tbody> </table> | Step | Temperature (°C) | Time (min.) | 1 | Min. Operating Temp.±3 | 30±3 | 2 | Room Temp. | 2 to 3 | 3 | Max. Operating Temp.±2 | 30±3 | 4 | Room Temp. | 2 to 3 |
| Step | Temperature (°C) | Time (min.) | | | | | | | | | | | | | | | | |
| 1 | Min. Operating Temp.±3 | 30±3 | | | | | | | | | | | | | | | | |
| 2 | Room Temp. | 2 to 3 | | | | | | | | | | | | | | | | |
| 3 | Max. Operating Temp.±2 | 30±3 | | | | | | | | | | | | | | | | |
| 4 | Room Temp. | 2 to 3 | | | | | | | | | | | | | | | | |
| | | |  <p style="text-align: center;">Glass Epoxy Board</p> <p style="text-align: center;">Fig. 4</p> | | | | | | | | | | | | | | | |
| 15 | Humidity (Steady State) | Appearance | No marking defects | | | | | | | | | | | | | | | |
| | | Capacitance Change | Within ±5.0% | | | | | | | | | | | | | | | |
| | | Q | 350 min. | | | | | | | | | | | | | | | |
| | | I.R. | More than 1,000MΩ | | | | | | | | | | | | | | | |
| | | Dielectric Strength | In accordance with item No.4 | | | | | | | | | | | | | | | |
| | | | Let the capacitor sit at 40±2°C and relative humidity of 90 to 95% for 500 ^{±2} hrs. Remove and let sit for 24±2 hrs. at room condition,* then measure. | | | | | | | | | | | | | | | |
| 16 | Life | Appearance | No marking defects | | | | | | | | | | | | | | | |
| | | Capacitance Change | Within ±3.0% | | | | | | | | | | | | | | | |
| | | Q | 350 min. | | | | | | | | | | | | | | | |
| | | I.R. | More than 1,000MΩ | | | | | | | | | | | | | | | |
| | | Dielectric Strength | In accordance with item No.4 | | | | | | | | | | | | | | | |
| | | | Apply 120% of the rated voltage for 1,000 ^{±4} hrs. at maximum operating temperature ±3°C. Remove and let sit for 24±2 hrs. at room condition,* then measure. The charge/discharge current is less than 50mA. | | | | | | | | | | | | | | | |

* "Room condition" Temperature: 15 to 35°C, Relative humidity: 45 to 75%, Atmospheric pressure: 86 to 106kPa

Chip Monolithic Ceramic Capacitors (Medium Voltage)



For Information Devices GR4 Series

■ Features

1. These items are designed specifically for telecommunications devices (IEEE802.3) in Ethernet LAN and primary-secondary coupling for DC-DC converters.
2. A new monolithic structure for small, high capacitance capable of operating at high voltage levels
3. Sn-plated external electrodes realize good solderability.
4. Only for reflow soldering

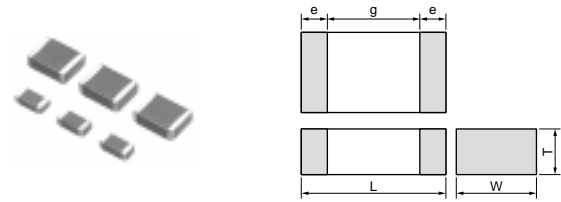

| Part Number | Dimensions (mm) | | | | |
|-------------|-----------------|----------|--------------|--------|--------|
| | L | W | T | e min. | g min. |
| GR442Q | 4.5 ±0.3 | 2.0 ±0.2 | 1.5 +0, -0.3 | 0.3 | 2.5 |
| GR443D | 4.5 ±0.4 | 3.2 ±0.3 | 2.0 +0, -0.3 | | |
| GR443Q | | | 1.5 +0, -0.3 | | |
| GR455D | 5.7 ±0.4 | 5.0 ±0.4 | 2.0 +0, -0.3 | | 3.2 |

■ Applications

1. Ideal for use on telecommunications devices in Ethernet LAN
2. Ideal for use as primary-secondary coupling for DC-DC converters

Do not use these products in any Automotive Power train or Safety equipment including Battery charger for Electric Vehicles and Plug-in Hybrid. Only Murata products clearly stipulated as "for Automotive use" can be used for automobile applications such as Power train and Safety equipment.

| Part Number | Rated Voltage (V) | TC Code (Standard) | Capacitance (pF) | Length L (mm) | Width W (mm) | Thickness T (mm) | Electrode g min. (mm) | Electrode e (mm) |
|--------------------|-------------------|--------------------|------------------|---------------|--------------|------------------|-----------------------|------------------|
| GR442QR73D101KW01L | DC2000 | X7R (EIA) | 100 ±10% | 4.5 | 2.0 | 1.5 | 2.5 | 0.3 min. |
| GR442QR73D121KW01L | DC2000 | X7R (EIA) | 120 ±10% | 4.5 | 2.0 | 1.5 | 2.5 | 0.3 min. |
| GR442QR73D151KW01L | DC2000 | X7R (EIA) | 150 ±10% | 4.5 | 2.0 | 1.5 | 2.5 | 0.3 min. |
| GR442QR73D181KW01L | DC2000 | X7R (EIA) | 180 ±10% | 4.5 | 2.0 | 1.5 | 2.5 | 0.3 min. |
| GR442QR73D221KW01L | DC2000 | X7R (EIA) | 220 ±10% | 4.5 | 2.0 | 1.5 | 2.5 | 0.3 min. |
| GR442QR73D271KW01L | DC2000 | X7R (EIA) | 270 ±10% | 4.5 | 2.0 | 1.5 | 2.5 | 0.3 min. |
| GR442QR73D331KW01L | DC2000 | X7R (EIA) | 330 ±10% | 4.5 | 2.0 | 1.5 | 2.5 | 0.3 min. |
| GR442QR73D391KW01L | DC2000 | X7R (EIA) | 390 ±10% | 4.5 | 2.0 | 1.5 | 2.5 | 0.3 min. |
| GR442QR73D471KW01L | DC2000 | X7R (EIA) | 470 ±10% | 4.5 | 2.0 | 1.5 | 2.5 | 0.3 min. |
| GR442QR73D561KW01L | DC2000 | X7R (EIA) | 560 ±10% | 4.5 | 2.0 | 1.5 | 2.5 | 0.3 min. |
| GR442QR73D681KW01L | DC2000 | X7R (EIA) | 680 ±10% | 4.5 | 2.0 | 1.5 | 2.5 | 0.3 min. |
| GR442QR73D821KW01L | DC2000 | X7R (EIA) | 820 ±10% | 4.5 | 2.0 | 1.5 | 2.5 | 0.3 min. |
| GR442QR73D102KW01L | DC2000 | X7R (EIA) | 1000 ±10% | 4.5 | 2.0 | 1.5 | 2.5 | 0.3 min. |
| GR442QR73D122KW01L | DC2000 | X7R (EIA) | 1200 ±10% | 4.5 | 2.0 | 1.5 | 2.5 | 0.3 min. |
| GR442QR73D152KW01L | DC2000 | X7R (EIA) | 1500 ±10% | 4.5 | 2.0 | 1.5 | 2.5 | 0.3 min. |
| GR443QR73D182KW01L | DC2000 | X7R (EIA) | 1800 ±10% | 4.5 | 3.2 | 1.5 | 2.5 | 0.3 min. |
| GR443QR73D222KW01L | DC2000 | X7R (EIA) | 2200 ±10% | 4.5 | 3.2 | 1.5 | 2.5 | 0.3 min. |
| GR443QR73D272KW01L | DC2000 | X7R (EIA) | 2700 ±10% | 4.5 | 3.2 | 1.5 | 2.5 | 0.3 min. |
| GR443QR73D332KW01L | DC2000 | X7R (EIA) | 3300 ±10% | 4.5 | 3.2 | 1.5 | 2.5 | 0.3 min. |
| GR443QR73D392KW01L | DC2000 | X7R (EIA) | 3900 ±10% | 4.5 | 3.2 | 1.5 | 2.5 | 0.3 min. |
| GR443DR73D472KW01L | DC2000 | X7R (EIA) | 4700 ±10% | 4.5 | 3.2 | 2.0 | 2.5 | 0.3 min. |
| GR455DR73D103KW01L | DC2000 | X7R (EIA) | 10000 ±10% | 5.7 | 5.0 | 2.0 | 3.2 | 0.3 min. |

For General Purpose GRM/GRJ Series

Only for Applications GR4 Series

AC250V Type GA2 Series

Safety Standard Certified GA3 Series

Product Information

GR4 Series Specifications and Test Methods

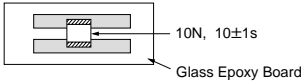
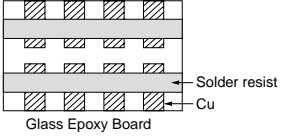
| No. | Item | Specifications | Test Method | | | | | | | | | | | | |
|---------------|---|--|---|---------------|------------------|------|-------|---------------------------|------------------------|-----------------|-----------|---|------------------------|---|------|
| 1 | Operating Temperature Range | -55 to +125°C | - | | | | | | | | | | | | |
| 2 | Appearance | No defects or abnormalities | Visual inspection | | | | | | | | | | | | |
| 3 | Dimensions | Within the specified dimensions | Using calipers and micrometers | | | | | | | | | | | | |
| 4 | Dielectric Strength | No defects or abnormalities | <p>No failure should be observed when voltage in the table is applied between the terminations, provided the charge/discharge current is less than 50mA.</p> <table border="1"> <thead> <tr> <th>Rated Voltage</th> <th>Test Voltage</th> <th>Time</th> </tr> </thead> <tbody> <tr> <td rowspan="2">DC2kV</td> <td>120% of the rated voltage</td> <td>60±1 sec.</td> </tr> <tr> <td>AC1500V(r.m.s.)</td> <td>60±1 sec.</td> </tr> </tbody> </table> | Rated Voltage | Test Voltage | Time | DC2kV | 120% of the rated voltage | 60±1 sec. | AC1500V(r.m.s.) | 60±1 sec. | | | | |
| Rated Voltage | Test Voltage | Time | | | | | | | | | | | | | |
| DC2kV | 120% of the rated voltage | 60±1 sec. | | | | | | | | | | | | | |
| | AC1500V(r.m.s.) | 60±1 sec. | | | | | | | | | | | | | |
| 5 | Pulse Voltage | No self healing breakdowns or flash-overs have taken place in the capacitor. | <p>10 impulses of alternating polarity are subjected. (5 impulses for each polarity) The interval between impulses is 60 sec. Applied Pulse: 1.2/50µs Applied Voltage: 2.5kVo-p</p> | | | | | | | | | | | | |
| 6 | Insulation Resistance (I.R.) | More than 6,000MΩ | The insulation resistance should be measured with DC500±50V and within 60±5 sec. of charging. | | | | | | | | | | | | |
| 7 | Capacitance | Within the specified tolerance | The capacitance/D.F. should be measured at a frequency of 1±0.2kHz and a voltage of AC1±0.2V(r.m.s.) | | | | | | | | | | | | |
| 8 | Dissipation Factor (D.F.) | 0.025 max. | | | | | | | | | | | | | |
| 9 | Capacitance Temperature Characteristics | Cap. Change within ±15% (Temp. Range: -55 to +125°C) | <p>The capacitance measurement should be made at each step specified in the Table.</p> <table border="1"> <thead> <tr> <th>Step</th> <th>Temperature (°C)</th> </tr> </thead> <tbody> <tr> <td>1</td> <td>25±2</td> </tr> <tr> <td>2</td> <td>Min. Operating Temp.±3</td> </tr> <tr> <td>3</td> <td>25±2</td> </tr> <tr> <td>4</td> <td>Max. Operating Temp.±2</td> </tr> <tr> <td>5</td> <td>25±2</td> </tr> </tbody> </table> <p>•Pretreatment Perform a heat treatment at 150±10°C for 60±5 min. and then let sit for 24±2 hrs. at room condition.*</p> | Step | Temperature (°C) | 1 | 25±2 | 2 | Min. Operating Temp.±3 | 3 | 25±2 | 4 | Max. Operating Temp.±2 | 5 | 25±2 |
| Step | Temperature (°C) | | | | | | | | | | | | | | |
| 1 | 25±2 | | | | | | | | | | | | | | |
| 2 | Min. Operating Temp.±3 | | | | | | | | | | | | | | |
| 3 | 25±2 | | | | | | | | | | | | | | |
| 4 | Max. Operating Temp.±2 | | | | | | | | | | | | | | |
| 5 | 25±2 | | | | | | | | | | | | | | |
| 10 | Adhesive Strength of Termination | No removal of the terminations or other defect should occur. | <p>Solder the capacitor to the testing jig (glass epoxy board) shown in Fig. 1. Then apply 10N force in the direction of the arrow. The soldering should be done using the reflow method and should be conducted with care so that the soldering is uniform and free of defects such as heat shock.</p>  <p style="text-align: center;">Fig. 1</p> | | | | | | | | | | | | |
| 11 | Vibration Resistance | Appearance | No defects or abnormalities | | | | | | | | | | | | |
| | | Capacitance | Within the specified tolerance | | | | | | | | | | | | |
| | D.F. | 0.025 max. | <p>Solder the capacitor to the test jig (glass epoxy board). The capacitor should be subjected to a simple harmonic motion having a total amplitude of 1.5mm, the frequency being varied uniformly between the approximate limits of 10 and 55Hz. The frequency range, from 10 to 55Hz and return to 10Hz, should be traversed in approximately 1 min. This motion should be applied for a period of 2 hrs. in each of 3 mutually perpendicular directions (total of 6 hrs.).</p>  | | | | | | | | | | | | |

* "Room condition" Temperature: 15 to 35°C, Relative humidity: 45 to 75%, Atmospheric pressure: 86 to 106kPa

Continued on the following page. 

GR4 Series Specifications and Test Methods

Continued from the preceding page.

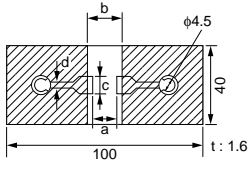
| No. | Item | Specifications | Test Method | | | | | | | | | | | | | | | | | | | |
|----------|------------------------------|--|---|----------|----------------|--|--|--|---|---|---|---|---------|-----|-----|-----|-----|---------|-----|-----|-----|---------|
| 12 | Deflection | No marking defects | Solder the capacitor to the testing jig (glass epoxy board) shown in Fig. 2. Then apply a force in the direction shown in Fig. 3. The soldering should be done using the reflow method and should be conducted with care so that the soldering is uniform and free of defects such as heat shock. | | | | | | | | | | | | | | | | | | | |
| | |  <p style="text-align: center;">Fig. 2</p> <table border="1" style="margin-left: auto; margin-right: auto;"> <thead> <tr> <th rowspan="2">L×W (mm)</th> <th colspan="4">Dimension (mm)</th> </tr> <tr> <th>a</th> <th>b</th> <th>c</th> <th>d</th> </tr> </thead> <tbody> <tr> <td>4.5×2.0</td> <td>3.5</td> <td>7.0</td> <td>2.4</td> <td rowspan="3" style="text-align: center;">1.0</td> </tr> <tr> <td>4.5×3.2</td> <td>3.5</td> <td>7.0</td> <td>3.7</td> </tr> <tr> <td>5.7×5.0</td> <td>4.5</td> <td>8.0</td> <td>5.6</td> </tr> </tbody> </table> | | L×W (mm) | Dimension (mm) | | | | a | b | c | d | 4.5×2.0 | 3.5 | 7.0 | 2.4 | 1.0 | 4.5×3.2 | 3.5 | 7.0 | 3.7 | 5.7×5.0 |
| L×W (mm) | Dimension (mm) | | | | | | | | | | | | | | | | | | | | | |
| | a | b | c | d | | | | | | | | | | | | | | | | | | |
| 4.5×2.0 | 3.5 | 7.0 | 2.4 | 1.0 | | | | | | | | | | | | | | | | | | |
| 4.5×3.2 | 3.5 | 7.0 | 3.7 | | | | | | | | | | | | | | | | | | | |
| 5.7×5.0 | 4.5 | 8.0 | 5.6 | | | | | | | | | | | | | | | | | | | |
| 13 | Solderability of Termination | 75% of the terminations are to be soldered evenly and continuously. | Immerse the capacitor in a solution of ethanol (JIS-K-8101) and rosin (JIS-K-5902) (25% rosin in weight proportion). Immerse in solder solution for 2±0.5 sec. Immersing speed: 25±2.5mm/s Temp. of solder: 245±5°C Lead Free Solder (Sn-3.0Ag-0.5Cu) 235±5°C H60A or H63A Eutectic Solder | | | | | | | | | | | | | | | | | | | |
| 14 | Resistance to Soldering Heat | Appearance | No marking defects | | | | | | | | | | | | | | | | | | | |
| | | Capacitance Change | Within ±10% | | | | | | | | | | | | | | | | | | | |
| | | D.F. | 0.025 max. | | | | | | | | | | | | | | | | | | | |
| | | I.R. | More than 1,000MΩ | | | | | | | | | | | | | | | | | | | |
| | | Dielectric Strength | In accordance with item No.4 | | | | | | | | | | | | | | | | | | | |
| 15 | Temperature Cycle | Appearance | No marking defects | | | | | | | | | | | | | | | | | | | |
| | | Capacitance Change | Within ±15% | | | | | | | | | | | | | | | | | | | |
| | | D.F. | 0.05 max. | | | | | | | | | | | | | | | | | | | |
| | | I.R. | More than 3,000MΩ | | | | | | | | | | | | | | | | | | | |
| | | Dielectric Strength | In accordance with item No.4 | | | | | | | | | | | | | | | | | | | |
| 16 | Humidity (Steady State) | Appearance | No marking defects | | | | | | | | | | | | | | | | | | | |
| | | Capacitance Change | Within ±15% | | | | | | | | | | | | | | | | | | | |
| | | D.F. | 0.05 max. | | | | | | | | | | | | | | | | | | | |
| | | I.R. | More than 1,000MΩ | | | | | | | | | | | | | | | | | | | |
| | | Dielectric Strength | In accordance with item No.4 | | | | | | | | | | | | | | | | | | | |

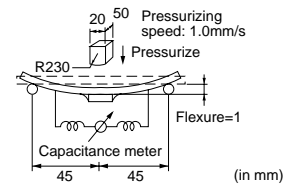

*Preheating

| Step | Temperature | Time |
|------|--------------|--------|
| 1 | 100 to 120°C | 1 min. |
| 2 | 170 to 200°C | 1 min. |

Perform the 5 cycles according to the 4 heat treatments listed in the following table.
 Let sit for 24±2 hrs. at room condition,* then measure.

| Step | Temperature (°C) | Time (min.) |
|------|------------------------|-------------|
| 1 | Min. Operating Temp.±3 | 30±3 |
| 2 | Room Temp. | 2 to 3 |
| 3 | Max. Operating Temp.±2 | 30±3 |
| 4 | Room Temp. | 2 to 3 |

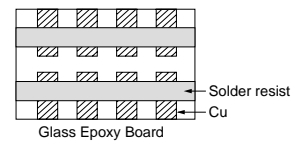

* "Room condition" Temperature: 15 to 35°C, Relative humidity: 45 to 75%, Atmospheric pressure: 86 to 106kPa

Continued on the following page.

For General Purpose GRM/GRJ Series
 Only for Applications GR4 Series
 AC250V Type GA2 Series
 Safety Standard Certified GA3 Series
 Product Information

GR4 Series Specifications and Test Methods

Continued from the preceding page.

| No. | Item | Specifications | Test Method |
|-----|------|------------------------------|--|
| 17 | Life | Appearance | Apply 110% of the rated voltage for 1,000 ^{±48} hrs. at maximum operating temperature ±3°C. Remove and let sit for 24±2 hrs. at room condition,* then measure. The charge/discharge current is less than 50mA. •Pretreatment Apply test voltage for 60±5 min. at test temperature. Remove and let sit for 24±2 hrs. at room condition.* |
| | | Capacitance Change | |
| | | D.F. | |
| | | I.R. | |
| | | Dielectric Strength | |
| | | No marking defects | |
| | | Within ±20% | |
| | | 0.05 max. | |
| | | More than 2,000MΩ | |
| | | In accordance with item No.4 | |

* "Room condition" Temperature: 15 to 35°C, Relative humidity: 45 to 75%, Atmospheric pressure: 86 to 106kPa

Chip Monolithic Ceramic Capacitors (Medium Voltage)



For Camera Flash Circuit GR7 Series

■ Features

1. Suitable for the trigger of the flash circuit, because real capacitance is stable during operating voltage.
2. The thin type fits thinner cameras.
3. Sn-plated external electrodes realize good solderability.
4. For flow and reflow soldering

■ Applications

For strobe circuit

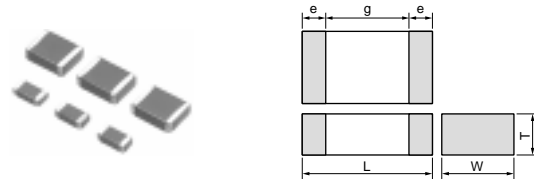

| Part Number | Dimensions (mm) | | | | |
|-------------|-----------------|-----------|---------------|--------|--------|
| | L | W | T | e min. | g min. |
| GR721A | 2.0 ±0.2 | 1.25 ±0.2 | 1.0 +0, -0.3 | 0.3 | 0.7 |
| GR721B | | | 1.25 ±0.2 | | |
| GR731A | 3.2 ±0.2 | 1.6 ±0.2 | 1.0 +0, -0.3 | | |
| GR731B | | | 1.25 +0, -0.3 | | |
| GR731C | | | 1.6 ±0.2 | | |

Do not use these products in any Automotive Power train or Safety equipment including Battery chargers for Electric Vehicles and Plug-in Hybrids. Only Murata products clearly stipulated as "for Automotive use" can be used for automobile applications such as Power train and Safety equipment.

| Part Number | Rated Voltage (V) | TC Code (Standard) | Capacitance (pF) | Length L (mm) | Width W (mm) | Thickness T (mm) | Electrode g min. (mm) | Electrode e (mm) |
|--------------------|-------------------|--------------------|------------------|---------------|--------------|------------------|-----------------------|------------------|
| GR721AW0BB103KW01D | DC350 | - | 10000 ±10% | 2.0 | 1.25 | 1.0 | 0.7 | 0.3 min. |
| GR731AW0BB103KW01D | DC350 | - | 10000 ±10% | 3.2 | 1.6 | 1.0 | 1.2 | 0.3 min. |
| GR721AW0BB153KW01D | DC350 | - | 15000 ±10% | 2.0 | 1.25 | 1.0 | 0.7 | 0.3 min. |
| GR731AW0BB153KW01D | DC350 | - | 15000 ±10% | 3.2 | 1.6 | 1.0 | 1.2 | 0.3 min. |
| GR721BW0BB223KW03L | DC350 | - | 22000 ±10% | 2.0 | 1.25 | 1.25 | 0.7 | 0.3 min. |
| GR731AW0BB223KW01D | DC350 | - | 22000 ±10% | 3.2 | 1.6 | 1.0 | 1.2 | 0.3 min. |
| GR731BW0BB223KW01L | DC350 | - | 22000 ±10% | 3.2 | 1.6 | 1.25 | 1.2 | 0.3 min. |
| GR721BW0BB273KW03L | DC350 | - | 27000 ±10% | 2.0 | 1.25 | 1.25 | 0.7 | 0.3 min. |
| GR731AW0BB273KW01D | DC350 | - | 27000 ±10% | 3.2 | 1.6 | 1.0 | 1.2 | 0.3 min. |
| GR731AW0BB333KW01D | DC350 | - | 33000 ±10% | 3.2 | 1.6 | 1.0 | 1.2 | 0.3 min. |
| GR731BW0BB333KW01L | DC350 | - | 33000 ±10% | 3.2 | 1.6 | 1.25 | 1.2 | 0.3 min. |
| GR731CW0BB473KW03L | DC350 | - | 47000 ±10% | 3.2 | 1.6 | 1.6 | 1.2 | 0.3 min. |

For General Purpose GRM/GRJ Series

Only for Applications GR7 Series

AC250V Type GA2 Series

Safety Standard Certified GA3 Series

Product Information

GR7 Series Specifications and Test Methods

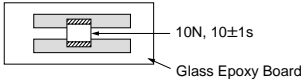
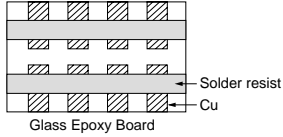
| No. | Item | Specifications | Test Method | | | | | | | | | |
|------|---|--|---|------|------------------|---|------|---|------------------------|---|------|---|
| 1 | Operating Temperature Range | -55 to +125°C | - | | | | | | | | | |
| 2 | Appearance | No defects or abnormalities | Visual inspection | | | | | | | | | |
| 3 | Dimensions | Within the specified dimensions | Using calipers and micrometers | | | | | | | | | |
| 4 | Dielectric Strength | No defects or abnormalities | No failure should be observed when DC500V is applied between the terminations for 1 to 5 sec., provided the charge/discharge current is less than 50mA. | | | | | | | | | |
| 5 | Insulation Resistance (I.R.) | C ≥ 0.01μF: More than 100MΩ • μF C < 0.01μF: More than 10,000MΩ | The insulation resistance should be measured with DC250±50V and within 60±5 sec. of charging. | | | | | | | | | |
| 6 | Capacitance | Within the specified tolerance | The capacitance/D.F. should be measured at a frequency of 1±0.2kHz and a voltage of AC1±0.2V(r.m.s.) | | | | | | | | | |
| 7 | Dissipation Factor (D.F.) | 0.025 max. | | | | | | | | | | |
| 8 | Capacitance Temperature Characteristics | Cap. Change Within ±10% (Apply DC350V bias) Within ±3% (No DC bias) (Temp. Range : -55 to +125°C) | The capacitance measurement should be made at each step specified in the Table. | | | | | | | | | |
| | | | <table border="1"> <thead> <tr> <th>Step</th> <th>Temperature (°C)</th> </tr> </thead> <tbody> <tr> <td>1</td> <td>25±2</td> </tr> <tr> <td>2</td> <td>Min. Operating Temp.±3</td> </tr> <tr> <td>3</td> <td>25±2</td> </tr> <tr> <td>4</td> <td>Max. Operating Temp.±2</td> </tr> <tr> <td>5</td> <td>25±2</td> </tr> </tbody> </table> <p>•Pretreatment Perform a heat treatment at 150±10°C for 60±5 min. and then let sit for 24±2 hrs. at room condition.*</p> | Step | Temperature (°C) | 1 | 25±2 | 2 | Min. Operating Temp.±3 | 3 | 25±2 | 4 |
| Step | Temperature (°C) | | | | | | | | | | | |
| 1 | 25±2 | | | | | | | | | | | |
| 2 | Min. Operating Temp.±3 | | | | | | | | | | | |
| 3 | 25±2 | | | | | | | | | | | |
| 4 | Max. Operating Temp.±2 | | | | | | | | | | | |
| 5 | 25±2 | | | | | | | | | | | |
| 9 | Adhesive Strength of Termination | No removal of the terminations or other defect should occur. | <p>Solder the capacitor to the testing jig (glass epoxy board) shown in Fig. 1.</p> <p>Then apply 10N force in the direction of the arrow.</p> <p>The soldering should be done using the reflow method and should be conducted with care so that the soldering is uniform and free of defects such as heat shock.</p>  <p>Fig. 1</p> | | | | | | | | | |
| 10 | Vibration Resistance | Appearance | No defects or abnormalities | | | | | | | | | |
| | | Capacitance | Within the specified tolerance | | | | | | | | | |
| | D.F. | 0.025 max. | <p>Solder the capacitor to the test jig (glass epoxy board). The capacitor should be subjected to a simple harmonic motion having a total amplitude of 1.5mm, the frequency being varied uniformly between the approximate limits of 10 and 55Hz. The frequency range, from 10 to 55Hz and return to 10Hz, should be traversed in approximately 1 min. This motion should be applied for a period of 2 hrs. in each of 3 mutually perpendicular directions (total of 6 hrs.).</p>  | | | | | | | | | |

* "Room condition" Temperature: 15 to 35°C, Relative humidity: 45 to 75%, Atmospheric pressure: 86 to 106kPa

Continued on the following page. 

GR7 Series Specifications and Test Methods

Continued from the preceding page.

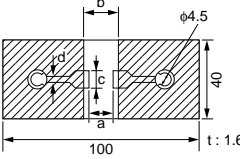
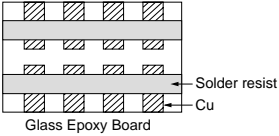
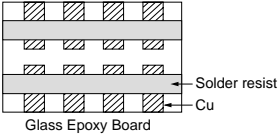
| No. | Item | Specifications | Test Method | | | | | | | | | | | | | | | |
|----------|------------------------------|---|--|----------|------------------|-------------|---|------------------------|------|---|------------|--------|----------|------------------------|------|------|------------|---------|
| 11 | Deflection | No marking defects | Solder the capacitor to the testing jig (glass epoxy board) shown in Fig. 2. Then apply a force in the direction shown in Fig. 3. The soldering should be done using the reflow method and should be conducted with care so that the soldering is uniform and free of defects such as heat shock. | | | | | | | | | | | | | | | |
| | |  <p style="text-align: center;">Fig. 2</p> <table border="1" style="margin-left: auto; margin-right: auto;"> <thead> <tr> <th rowspan="2">L×W (mm)</th> <th colspan="4">Dimension (mm)</th> </tr> <tr> <th>a</th> <th>b</th> <th>c</th> <th>d</th> </tr> </thead> <tbody> <tr> <td>2.0×1.25</td> <td>1.2</td> <td>4.0</td> <td>1.65</td> <td rowspan="2">1.0</td> </tr> <tr> <td>3.2×1.6</td> <td>2.2</td> <td>5.0</td> <td>2.0</td> </tr> </tbody> </table> | | L×W (mm) | Dimension (mm) | | | | a | b | c | d | 2.0×1.25 | 1.2 | 4.0 | 1.65 | 1.0 | 3.2×1.6 |
| L×W (mm) | Dimension (mm) | | | | | | | | | | | | | | | | | |
| | a | b | c | d | | | | | | | | | | | | | | |
| 2.0×1.25 | 1.2 | 4.0 | 1.65 | 1.0 | | | | | | | | | | | | | | |
| 3.2×1.6 | 2.2 | 5.0 | 2.0 | | | | | | | | | | | | | | | |
| | | |  <p style="text-align: center;">Fig. 3</p> | | | | | | | | | | | | | | | |
| 12 | Solderability of Termination | 75% of the terminations are to be soldered evenly and continuously. | Immerse the capacitor in a solution of ethanol (JIS-K-8101) and rosin (JIS-K-5902) (25% rosin in weight proportion). Immerse in solder solution for 2±0.5 sec. Immersing speed: 25±2.5mm/s Temp. of solder: 245±5°C Lead Free Solder (Sn-3.0Ag-0.5Cu) 235±5°C H60A or H63A Eutectic Solder | | | | | | | | | | | | | | | |
| 13 | Resistance to Soldering Heat | Appearance | No marking defects | | | | | | | | | | | | | | | |
| | | Capacitance Change | Within ±10% | | | | | | | | | | | | | | | |
| | | D.F. | 0.025 max. | | | | | | | | | | | | | | | |
| | | I.R. | C≥0.01μF: More than 100MΩ • μF C<0.01μF: More than 10,000MΩ | | | | | | | | | | | | | | | |
| | | Dielectric Strength | In accordance with item No.4 | | | | | | | | | | | | | | | |
| | | | Preheat the capacitor at 120 to 150°C for 1 min. Immerse the capacitor in solder solution at 260±5°C for 10±1 sec. Let sit at room condition* for 24±2 hrs., then measure. •Immersing speed: 25±2.5mm/s •Pretreatment Perform a heat treatment at 150±1.8 °C for 60±5 min. and then let sit for 24±2 hrs. at room condition.* | | | | | | | | | | | | | | | |
| 14 | Temperature Cycle | Appearance | No marking defects | | | | | | | | | | | | | | | |
| | | Capacitance Change | Within ±7.5% | | | | | | | | | | | | | | | |
| | | D.F. | 0.025 max. | | | | | | | | | | | | | | | |
| | | I.R. | C≥0.01μF: More than 100MΩ • μF C<0.01μF: More than 10,000MΩ | | | | | | | | | | | | | | | |
| | | Dielectric Strength | In accordance with item No.4 | | | | | | | | | | | | | | | |
| | | | Fix the capacitor to the supporting jig (glass epoxy board) shown in Fig. 4. Perform the 5 cycles according to the 4 heat treatments listed in the following table. Let sit for 24±2 hrs. at room condition,* then measure. | | | | | | | | | | | | | | | |
| | | | <table border="1" style="margin-left: auto; margin-right: auto;"> <thead> <tr> <th>Step</th> <th>Temperature (°C)</th> <th>Time (min.)</th> </tr> </thead> <tbody> <tr> <td>1</td> <td>Min. Operating Temp.±3</td> <td>30±3</td> </tr> <tr> <td>2</td> <td>Room Temp.</td> <td>2 to 3</td> </tr> <tr> <td>3</td> <td>Max. Operating Temp.±2</td> <td>30±3</td> </tr> <tr> <td>4</td> <td>Room Temp.</td> <td>2 to 3</td> </tr> </tbody> </table> | Step | Temperature (°C) | Time (min.) | 1 | Min. Operating Temp.±3 | 30±3 | 2 | Room Temp. | 2 to 3 | 3 | Max. Operating Temp.±2 | 30±3 | 4 | Room Temp. | 2 to 3 |
| Step | Temperature (°C) | Time (min.) | | | | | | | | | | | | | | | | |
| 1 | Min. Operating Temp.±3 | 30±3 | | | | | | | | | | | | | | | | |
| 2 | Room Temp. | 2 to 3 | | | | | | | | | | | | | | | | |
| 3 | Max. Operating Temp.±2 | 30±3 | | | | | | | | | | | | | | | | |
| 4 | Room Temp. | 2 to 3 | | | | | | | | | | | | | | | | |
| | | | •Pretreatment Perform a heat treatment at 150±1.8 °C for 60±5 min. and then let sit for 24±2 hrs. at room condition.* | | | | | | | | | | | | | | | |
| | | |  <p style="text-align: center;">Fig. 4</p> | | | | | | | | | | | | | | | |
| 15 | Humidity (Steady State) | Appearance | No marking defects | | | | | | | | | | | | | | | |
| | | Capacitance Change | Within ±15% | | | | | | | | | | | | | | | |
| | | D.F. | 0.05 max. | | | | | | | | | | | | | | | |
| | | I.R. | C≥0.01μF: More than 10MΩ • μF C<0.01μF: More than 1,000MΩ | | | | | | | | | | | | | | | |
| | | Dielectric Strength | In accordance with item No.4 | | | | | | | | | | | | | | | |
| | | | Let the capacitor sit at 40±2°C and relative humidity of 90 to 95% for 500±24 hrs. Remove and let sit for 24±2 hrs. at room condition,* then measure. •Pretreatment Perform a heat treatment at 150±1.8 °C for 60±5 min. and then let sit for 24±2 hrs. at room condition.* | | | | | | | | | | | | | | | |

* "Room condition" Temperature: 15 to 35°C, Relative humidity: 45 to 75%, Atmospheric pressure: 86 to 106kPa

Continued on the following page.

For General Purpose GRM/GRJ Series

Only for Applications GR7 Series

AC250V Type GA2 Series

Safety Standard Certified GA3 Series

Product Information

GR7 Series Specifications and Test Methods

Continued from the preceding page.

| No. | Item | Specifications | Test Method |
|-----|------------------|---------------------|--|
| 16 | Life | Appearance | No marking defects |
| | | Capacitance Change | Within $\pm 15\%$ |
| | | D.F. | 0.05 max. |
| | | I.R. | $C \geq 0.01\mu\text{F}$: More than $10\text{M}\Omega \cdot \mu\text{F}$ $C < 0.01\mu\text{F}$: More than $1,000\text{M}\Omega$ |
| | | Dielectric Strength | In accordance with item No.4 |
| 17 | Humidity Loading | Appearance | No marking defects |
| | | Capacitance Change | Within $\pm 15\%$ |
| | | D.F. | 0.05 max. |
| | | I.R. | $C \geq 0.01\mu\text{F}$: More than $10\text{M}\Omega \cdot \mu\text{F}$ $C < 0.01\mu\text{F}$: More than $1,000\text{M}\Omega$ |
| | | Dielectric Strength | In accordance with item No.4 |
| | | | Apply DC350V for $1,000^{+48}$ hrs. at maximum operating temperature $\pm 3^\circ\text{C}$. Remove and let sit for 24 ± 2 hrs. at room condition,* then measure. The charge/discharge current is less than 50mA. •Pretreatment Apply test voltage for 60 ± 5 min. at test temperature. Remove and let sit for 24 ± 2 hrs. at room condition.* |
| | | | Apply the rated voltage at $40 \pm 2^\circ\text{C}$ and relative humidity of 90 to 95% for 500^{+24} hrs. Remove and let sit for 24 ± 2 hrs. at room condition,* then measure. •Pretreatment Apply test voltage for 60 ± 5 min. at test temperature. Remove and let sit for 24 ± 2 hrs. at room condition.* |

* "Room condition" Temperature: 15 to 35°C, Relative humidity: 45 to 75%, Atmospheric pressure: 86 to 106kPa

Chip Monolithic Ceramic Capacitors



AC250V Type (Which Meet Japanese Law) GA2 Series

■ Features

1. Chip monolithic ceramic capacitor for AC lines.
2. A new monolithic structure for small, high capacitance capable of operating at high voltage levels.
3. Sn-plated external electrodes realize good solderability.
4. Only for reflow soldering
5. Capacitance 0.01 to 0.1uF for connecting lines and 470 to 4700pF for connecting lines to earth.

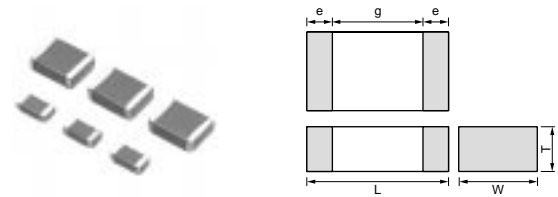

| Part Number | Dimensions (mm) | | | | |
|---------------|-----------------|----------|--------------|--------|--------|
| | L | W | T | e min. | g min. |
| GA242Q | 4.5 ±0.3 | 2.0 ±0.2 | 1.5 +0, -0.3 | 0.3 | 2.5 |
| GA243D | 4.5 ±0.4 | 3.2 ±0.3 | 2.0 +0, -0.3 | | |
| GA243Q | | | 1.5 +0, -0.3 | | |
| GA255D | 5.7 ±0.4 | 5.0 ±0.4 | 2.0 +0, -0.3 | | 3.2 |

■ Applications

Noise suppression filters for switching power supplies, telephones, facsimiles, modems.

Do not use these products in any Automotive Power train or Safety equipment including Battery chargers for Electric Vehicles and Plug-in Hybrids. Only Murata products clearly stipulated as "for Automotive use" can be used for automobile applications such as Power train and Safety equipment.

■ Reference Standard

GA2 series obtains no safety approval. This series is based on the standards of the electrical appliance and material safety law of Japan (separated table 4).

| Part Number | Rated Voltage (V) | TC Code (Standard) | Capacitance | Length L (mm) | Width W (mm) | Thickness T (mm) | Electrode g min. (mm) | Electrode e (mm) |
|---------------------------|-------------------|--------------------|--------------|---------------|--------------|------------------|-----------------------|------------------|
| GA242QR7E2471MW01L | AC250 (r.m.s.) | X7R (EIA) | 470pF ±20% | 4.5 | 2.0 | 1.5 | 2.5 | 0.3 min. |
| GA242QR7E2102MW01L | AC250 (r.m.s.) | X7R (EIA) | 1000pF ±20% | 4.5 | 2.0 | 1.5 | 2.5 | 0.3 min. |
| GA243QR7E2222MW01L | AC250 (r.m.s.) | X7R (EIA) | 2200pF ±20% | 4.5 | 3.2 | 1.5 | 2.5 | 0.3 min. |
| GA243QR7E2332MW01L | AC250 (r.m.s.) | X7R (EIA) | 3300pF ±20% | 4.5 | 3.2 | 1.5 | 2.5 | 0.3 min. |
| GA243DR7E2472MW01L | AC250 (r.m.s.) | X7R (EIA) | 4700pF ±20% | 4.5 | 3.2 | 2.0 | 2.5 | 0.3 min. |
| GA243QR7E2103MW01L | AC250 (r.m.s.) | X7R (EIA) | 10000pF ±20% | 4.5 | 3.2 | 1.5 | 2.5 | 0.3 min. |
| GA243QR7E2223MW01L | AC250 (r.m.s.) | X7R (EIA) | 22000pF ±20% | 4.5 | 3.2 | 1.5 | 2.5 | 0.3 min. |
| GA243DR7E2473MW01L | AC250 (r.m.s.) | X7R (EIA) | 47000pF ±20% | 4.5 | 3.2 | 2.0 | 2.5 | 0.3 min. |
| GA255DR7E2104MW01L | AC250 (r.m.s.) | X7R (EIA) | 0.10μF ±20% | 5.7 | 5.0 | 2.0 | 3.2 | 0.3 min. |

For General Purpose GRM/GRJ Series

Only for Applications

AC250V Type GA2 Series

Safety Standard Certified GA3 Series

Product Information

GA2 Series Specifications and Test Methods

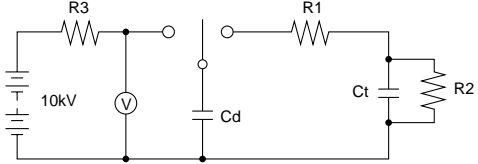
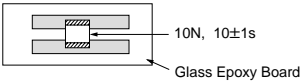
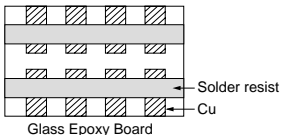
| No. | Item | Specifications | Test Method | | | | | | | | | | | | |
|---------------------|--|---|--|---------------------|------------------|--------------|-----------------|--------------|------------------------|---|------|---|------------------------|---|------|
| 1 | Operating Temperature Range | -55 to +125°C | - | | | | | | | | | | | | |
| 2 | Appearance | No defects or abnormalities | Visual inspection | | | | | | | | | | | | |
| 3 | Dimensions | Within the specified dimensions | Using calipers and micrometers | | | | | | | | | | | | |
| 4 | Dielectric Strength | No defects or abnormalities | No failure should be observed when voltage in the table is applied between the terminations for 60±1 sec., provided the charge/discharge current is less than 50mA. <table border="1"> <thead> <tr> <th>Nominal Capacitance</th> <th>Test Voltage</th> </tr> </thead> <tbody> <tr> <td>C ≥ 10,000pF</td> <td>AC575V (r.m.s.)</td> </tr> <tr> <td>C < 10,000pF</td> <td>AC1500V (r.m.s.)</td> </tr> </tbody> </table> | Nominal Capacitance | Test Voltage | C ≥ 10,000pF | AC575V (r.m.s.) | C < 10,000pF | AC1500V (r.m.s.) | | | | | | |
| Nominal Capacitance | Test Voltage | | | | | | | | | | | | | | |
| C ≥ 10,000pF | AC575V (r.m.s.) | | | | | | | | | | | | | | |
| C < 10,000pF | AC1500V (r.m.s.) | | | | | | | | | | | | | | |
| 5 | Insulation Resistance (I.R.) | More than 2,000MΩ | The insulation resistance should be measured with DC500±50V and within 60±5 sec. of charging. | | | | | | | | | | | | |
| 6 | Capacitance | Within the specified tolerance | The capacitance/D.F. should be measured at a frequency of 1±0.2kHz and a voltage of AC1±0.2V (r.m.s.) | | | | | | | | | | | | |
| 7 | Dissipation Factor (D.F.) | 0.025 max. | | | | | | | | | | | | | |
| 8 | Capacitance Temperature Characteristics | Cap. Change Within ±15% (Temp. Range: -55 to +125°C) | The capacitance measurement should be made at each step specified in the Table. <table border="1"> <thead> <tr> <th>Step</th> <th>Temperature (°C)</th> </tr> </thead> <tbody> <tr> <td>1</td> <td>25±2</td> </tr> <tr> <td>2</td> <td>Min. Operating Temp.±3</td> </tr> <tr> <td>3</td> <td>25±2</td> </tr> <tr> <td>4</td> <td>Max. Operating Temp.±2</td> </tr> <tr> <td>5</td> <td>25±2</td> </tr> </tbody> </table> <p>•Pretreatment Perform a heat treatment at 150±10°C for 60±5 min. and then let sit for 24±2 hrs. at room condition.*</p> | Step | Temperature (°C) | 1 | 25±2 | 2 | Min. Operating Temp.±3 | 3 | 25±2 | 4 | Max. Operating Temp.±2 | 5 | 25±2 |
| Step | Temperature (°C) | | | | | | | | | | | | | | |
| 1 | 25±2 | | | | | | | | | | | | | | |
| 2 | Min. Operating Temp.±3 | | | | | | | | | | | | | | |
| 3 | 25±2 | | | | | | | | | | | | | | |
| 4 | Max. Operating Temp.±2 | | | | | | | | | | | | | | |
| 5 | 25±2 | | | | | | | | | | | | | | |
| 9 | Discharge Test (Application: Nominal Capacitance C < 10,000pF) | Appearance | No defects or abnormalities <p>As in Fig., discharge is made 50 times at 5 sec. intervals from the capacitor (Cd) charged at DC voltage of specified.</p>  <p>Ct: Capacitor under test Cd: 0.001μF R1: 1,000Ω R2: 100MΩ R3: Surge resistance</p> | | | | | | | | | | | | |
| 10 | Adhesive Strength of Termination | No removal of the terminations or other defects should occur. | Solder the capacitor to the testing jig (glass epoxy board) shown in Fig. 1. Then apply 10N force in the direction of the arrow. The soldering should be done using the reflow method and should be conducted with care so that the soldering is uniform and free of defects such as heat shock.  <p>Fig. 1</p> | | | | | | | | | | | | |
| 11 | Vibration Resistance | Appearance | No defects or abnormalities | | | | | | | | | | | | |
| | | Capacitance | Within the specified tolerance | | | | | | | | | | | | |
| | D.F. | 0.025 max. | The capacitor should be subjected to a simple harmonic motion having a total amplitude of 1.5mm, the frequency being varied uniformly between the approximate limits of 10 and 55Hz. The frequency range, from 10 to 55Hz and return to 10Hz, should be traversed in approximately 1 min. This motion should be applied for a period of 2 hrs. in each of 3 mutually perpendicular directions (total of 6 hrs.).  <p>Glass Epoxy Board</p> | | | | | | | | | | | | |

* "Room condition" Temperature: 15 to 35°C, Relative humidity: 45 to 75%, Atmospheric pressure: 86 to 106kPa

Continued on the following page. 

GA2 Series Specifications and Test Methods

Continued from the preceding page.

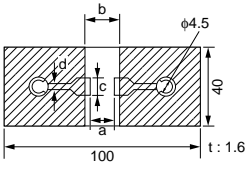
| No. | Item | Specifications | Test Method | | | | | | | | | | | | | | | | | | | |
|----------|------------------------------|--|--|----------|----------------|--|--|--|---|---|---|---|---------|-----|-----|-----|-----|---------|-----|-----|-----|---------|
| 12 | Deflection | No marking defects | Solder the capacitor to the testing jig (glass epoxy board) shown in Fig. 2. Then apply a force in the direction shown in Fig. 3. The soldering should be done using the reflow method and should be conducted with care so that the soldering is uniform and free of defects such as heat shock. | | | | | | | | | | | | | | | | | | | |
| | |  <p style="text-align: center;">Fig. 2</p> <table border="1" style="margin-left: auto; margin-right: auto;"> <thead> <tr> <th rowspan="2">L×W (mm)</th> <th colspan="4">Dimension (mm)</th> </tr> <tr> <th>a</th> <th>b</th> <th>c</th> <th>d</th> </tr> </thead> <tbody> <tr> <td>4.5×2.0</td> <td>3.5</td> <td>7.0</td> <td>2.4</td> <td rowspan="3" style="text-align: center;">1.0</td> </tr> <tr> <td>4.5×3.2</td> <td>3.5</td> <td>7.0</td> <td>3.7</td> </tr> <tr> <td>5.7×5.0</td> <td>4.5</td> <td>8.0</td> <td>5.6</td> </tr> </tbody> </table> | | L×W (mm) | Dimension (mm) | | | | a | b | c | d | 4.5×2.0 | 3.5 | 7.0 | 2.4 | 1.0 | 4.5×3.2 | 3.5 | 7.0 | 3.7 | 5.7×5.0 |
| L×W (mm) | Dimension (mm) | | | | | | | | | | | | | | | | | | | | | |
| | a | b | c | d | | | | | | | | | | | | | | | | | | |
| 4.5×2.0 | 3.5 | 7.0 | 2.4 | 1.0 | | | | | | | | | | | | | | | | | | |
| 4.5×3.2 | 3.5 | 7.0 | 3.7 | | | | | | | | | | | | | | | | | | | |
| 5.7×5.0 | 4.5 | 8.0 | 5.6 | | | | | | | | | | | | | | | | | | | |
| 13 | Solderability of Termination | 75% of the terminations are to be soldered evenly and continuously. | Immerse the capacitor in a solution of ethanol (JIS-K-8101) and rosin (JIS-K-5902) (25% rosin in weight proportion). Immerse in solder solution for 2±0.5 sec. Immersing speed: 25±2.5mm/s Temp. of solder: 245±5°C Lead Free Solder (Sn-3.0Ag-0.5Cu) 235±5°C H60A or H63A Eutectic Solder | | | | | | | | | | | | | | | | | | | |
| 14 | Humidity Insulation | Appearance | No marking defects | | | | | | | | | | | | | | | | | | | |
| | | Capacitance Change | Within ±15% | | | | | | | | | | | | | | | | | | | |
| | | D.F. | 0.05 max. | | | | | | | | | | | | | | | | | | | |
| | | I.R. | More than 1,000MΩ | | | | | | | | | | | | | | | | | | | |
| | | Dielectric Strength | In accordance with item No.4 | | | | | | | | | | | | | | | | | | | |
| 15 | Resistance to Soldering Heat | Appearance | No marking defects | | | | | | | | | | | | | | | | | | | |
| | | Capacitance Change | Within ±10% | | | | | | | | | | | | | | | | | | | |
| | | D.F. | 0.025 max. | | | | | | | | | | | | | | | | | | | |
| | | I.R. | More than 2,000MΩ | | | | | | | | | | | | | | | | | | | |
| | | Dielectric Strength | In accordance with item No.4 | | | | | | | | | | | | | | | | | | | |
| 16 | Temperature Cycle | Appearance | No marking defects | | | | | | | | | | | | | | | | | | | |
| | | Capacitance Change | Within ±15% | | | | | | | | | | | | | | | | | | | |
| | | D.F. | 0.05 max. | | | | | | | | | | | | | | | | | | | |
| | | I.R. | More than 2,000MΩ | | | | | | | | | | | | | | | | | | | |
| | | Dielectric Strength | In accordance with item No.4 | | | | | | | | | | | | | | | | | | | |

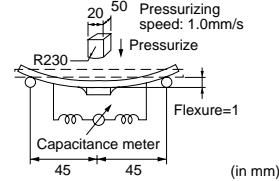

Fig. 3

| Step | Temperature | Time |
|------|--------------|--------|
| 1 | 100 to 120°C | 1 min. |
| 2 | 170 to 200°C | 1 min. |

| Step | Temperature (°C) | Time (min.) |
|------|------------------------|-------------|
| 1 | Min. Operating Temp.±3 | 30±3 |
| 2 | Room Temp. | 2 to 3 |
| 3 | Max. Operating Temp.±2 | 30±3 |
| 4 | Room Temp. | 2 to 3 |

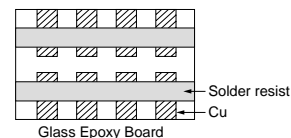

Fig. 4

* "Room condition" Temperature: 15 to 35°C, Relative humidity: 45 to 75%, Atmospheric pressure: 86 to 106kPa

Continued on the following page. ↗

For General Purpose GRM/GRJ Series

Only for Applications

AC250V Type GA2 Series

Safety Standard Certified GA3 Series

Product Information

GA2 Series Specifications and Test Methods

Continued from the preceding page.

| No. | Item | Specifications | Test Method | | | | | | | | | |
|--------------------------|----------------------------|---------------------|---|---------------------|-----------|--------------|--------------------------|-------------------------|-----------------|-----------------------|-------------------------|------------------|
| 17 | Humidity (Steady State) | Appearance | No marking defects | | | | | | | | | |
| | | Capacitance Change | Within $\pm 15\%$ | | | | | | | | | |
| | | D.F. | 0.05 max. | | | | | | | | | |
| | | I.R. | More than 1,000M Ω | | | | | | | | | |
| | | Dielectric Strength | In accordance with item No.4 | | | | | | | | | |
| | | | Let the capacitor sit at $40\pm 2^\circ\text{C}$ and relative humidity of 90 to 95% for 500^{+24}_{-8} hrs. Remove and let sit for 24 ± 2 hrs. at room condition,* then measure. •Pretreatment Perform a heat treatment at $150\pm 3^\circ\text{C}$ for 60 ± 5 min. and then let sit for 24 ± 2 hrs. at room condition.* | | | | | | | | | |
| 18 | Life | Appearance | No marking defects | | | | | | | | | |
| | | Capacitance Change | Within $\pm 20\%$ | | | | | | | | | |
| | | D.F. | 0.05 max. | | | | | | | | | |
| | | I.R. | More than 1,000M Ω | | | | | | | | | |
| | | Dielectric Strength | In accordance with item No.4 | | | | | | | | | |
| | | | Apply voltage and time as in Table at maximum operating temperature $\pm 3^\circ\text{C}$. Remove and let sit for 24 ± 2 hrs. at room condition,* then measure. The charge / discharge current is less than 50mA. <table border="1" style="margin-left: auto; margin-right: auto;"> <thead> <tr> <th>Nominal Capacitance</th> <th>Test Time</th> <th>Test Voltage</th> </tr> </thead> <tbody> <tr> <td>$C \geq 10,000\text{pF}$</td> <td>$1,000^{+48}_{-8}$ hrs.</td> <td>AC300V (r.m.s.)</td> </tr> <tr> <td>$C < 10,000\text{pF}$</td> <td>$1,500^{+48}_{-8}$ hrs.</td> <td>AC500V (r.m.s.)*</td> </tr> </tbody> </table> * Except that once each hour the voltage is increased to AC1,000V (r.m.s.) for 0.1 sec. •Pretreatment Apply test voltage for 60 ± 5 min. at test temperature. Remove and let sit for 24 ± 2 hrs. at room condition.* | Nominal Capacitance | Test Time | Test Voltage | $C \geq 10,000\text{pF}$ | $1,000^{+48}_{-8}$ hrs. | AC300V (r.m.s.) | $C < 10,000\text{pF}$ | $1,500^{+48}_{-8}$ hrs. | AC500V (r.m.s.)* |
| Nominal Capacitance | Test Time | Test Voltage | | | | | | | | | | |
| $C \geq 10,000\text{pF}$ | $1,000^{+48}_{-8}$ hrs. | AC300V (r.m.s.) | | | | | | | | | | |
| $C < 10,000\text{pF}$ | $1,500^{+48}_{-8}$ hrs. | AC500V (r.m.s.)* | | | | | | | | | | |
| 19 | Humidity Loading | Appearance | No marking defects | | | | | | | | | |
| | | Capacitance Change | Within $\pm 15\%$ | | | | | | | | | |
| | | D.F. | 0.05 max. | | | | | | | | | |
| | | I.R. | More than 1,000M Ω | | | | | | | | | |
| | | Dielectric Strength | In accordance with item No.4 | | | | | | | | | |
| | | | Apply the rated voltage at $40\pm 2^\circ\text{C}$ and relative humidity of 90 to 95% for 500^{+24}_{-8} hrs. Remove and let sit for 24 ± 2 hrs. at room condition,* then measure. •Pretreatment Apply test voltage for 60 ± 5 min. at test temperature. Remove and let sit for 24 ± 2 hrs. at room condition.* | | | | | | | | | |

* "Room condition" Temperature: 15 to 35 $^\circ\text{C}$, Relative humidity: 45 to 75%, Atmospheric pressure: 86 to 106kPa

Chip Monolithic Ceramic Capacitors



Safety Standard Certified GA3 Series UL, IEC60384-14 Class X1/Y2 Type GC

■ Features

1. Chip monolithic ceramic capacitor (certified as conforming to safety standards) for AC lines.
2. A new monolithic structure for small, high capacitance capable of operating at high voltage levels.
3. Compared to lead type capacitors, this new capacitor is greatly downsized and low-profiled to 1/10 or less in volume, and 1/4 or less in height.
4. Type GC can be used as an X1-class and Y2-class capacitor, line-by-pass capacitor of UL1414.
5. +125 degree C guaranteed
6. Only for reflow soldering

■ Applications

1. Ideal for use as Y capacitor or X capacitor for various switching power supplies
2. Ideal for modem applications

Do not use these products in any Automotive Power train or Safety equipment including Battery chargers for Electric Vehicles and Plug-in Hybrids. Only Murata products clearly stipulated as "for Automotive use" can be used for automobile applications such as Power train and Safety equipment.

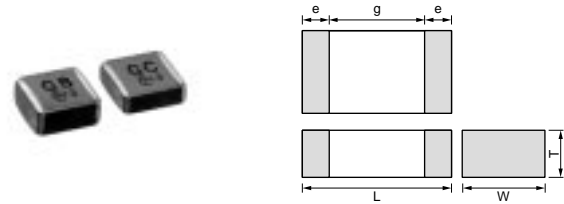

| Part Number | Dimensions (mm) | | | | |
|---------------|-----------------|----------|----------|--------|--------|
| | L | W | T | e min. | g min. |
| GA355D | 5.7 ±0.4 | 5.0 ±0.4 | 2.0 ±0.3 | 0.3 | 4.0 |

■ Standard Certification

| | Standard No. | Class | Rated Voltage |
|-------|--|--------------|--------------------|
| UL | UL1414 | Line By-pass | AC250V (r.m.s.) |
| VDE | IEC 60384-14 EN 60384-14 | X1, Y2 | |
| BSI | EN 60065 (14.2) IEC 60384-14 EN 60384-14 | | |
| SEMKO | IEC 60384-14 EN 60384-14 | | |
| ESTI | EN 60065 IEC 60384-14 | | |

| Part Number | Rated Voltage (V) | TC Code (Standard) | Capacitance (pF) | Length L (mm) | Width W (mm) | Thickness T (mm) | Electrode g min. (mm) | Electrode e (mm) |
|---------------------------|-------------------|--------------------|------------------|---------------|--------------|------------------|-----------------------|------------------|
| GA355DR7GC101KY02L | AC250 (r.m.s.) | X7R (EIA) | 100 ±10% | 5.7 | 5.0 | 2.0 | 4.0 | 0.3 min. |
| GA355DR7GC151KY02L | AC250 (r.m.s.) | X7R (EIA) | 150 ±10% | 5.7 | 5.0 | 2.0 | 4.0 | 0.3 min. |
| GA355DR7GC221KY02L | AC250 (r.m.s.) | X7R (EIA) | 220 ±10% | 5.7 | 5.0 | 2.0 | 4.0 | 0.3 min. |
| GA355DR7GC331KY02L | AC250 (r.m.s.) | X7R (EIA) | 330 ±10% | 5.7 | 5.0 | 2.0 | 4.0 | 0.3 min. |

For General Purpose GRM/GRJ Series

Only for Applications

AC250V Type GA2 Series

Safety Standard Certified GA3 Series

Product Information

Chip Monolithic Ceramic Capacitors



Safety Standard Certified GA3 Series IEC60384-14 Class Y2, X1/Y2 Type GF

■ Features

1. Available for equipment based on IEC/EN60950 and UL1950. Besides, the GA352/355 types are available for equipment based on IEC/EN60065, UL1492, and UL6500.
2. Type GF can be used as a Y2-class capacitor.
3. A new monolithic structure for small, high capacitance capable of operating at high voltage levels.
4. +125 degree C guaranteed
5. Only for reflow soldering

■ Applications

1. Ideal for use on line filters and couplings for DAA modems without transformers
2. Ideal for use on line filters for information equipment
3. Ideal for use as Y capacitor or X capacitor for various switching power supplies (GA352/355 types only)

Do not use these products in any Automotive Power train or Safety equipment including Battery chargers for Electric Vehicles and Plug-in Hybrids. Only Murata products clearly stipulated as "for Automotive use" can be used for automobile applications such as Power train and Safety equipment.

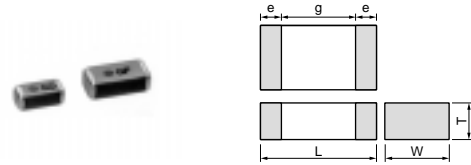

| Part Number | Dimensions (mm) | | | | |
|-------------|-----------------|----------|--------------|--------|--------|
| | L | W | T | e min. | g min. |
| GA342A | 4.5 ±0.3 | 2.0 ±0.2 | 1.0 +0, -0.3 | 0.3 | 2.5 |
| GA342D | | | 2.0 ±0.2 | | |
| GA342Q | | | 1.5 +0, -0.3 | | |
| GA352Q | 5.7 ±0.4 | 2.8 ±0.3 | 1.5 +0, -0.3 | | 4.0 |
| GA355D | | | 2.0 +0, -0.3 | | |
| GA355Q | | | 1.5 +0, -0.3 | | |

■ Standard Certification

| | Standard No. | Class | Status of Certification | | Rated Voltage |
|-------|--------------|--------|-------------------------|---------------------------|--------------------|
| | | | Size : 4.5x2.0mm | Size : 5.7x2.8mm and over | |
| UL | UL1414 | X1, Y2 | — | ⊙ | AC250V (r.m.s.) |
| | UL 60950-1 | — | ⊙ | — | |
| VDE | IEC 60384-14 | X1, Y2 | — | ⊙ | (r.m.s.) |
| SEMKO | EN 60384-14 | Y2 | ⊙ | ⊙ | |

Applications

| Size | Switching power supplies | Communication network devices such as a modem |
|--------------------|--------------------------|---|
| 4.5x2.0mm | — | ⊙ |
| 5.7x2.8mm and over | ⊙ | ⊙ |

| Part Number | Rated Voltage (V) | TC Code (Standard) | Capacitance (pF) | Length L (mm) | Width W (mm) | Thickness T (mm) | Electrode g min. (mm) | Electrode e (mm) |
|--------------------|-------------------|--------------------|------------------|---------------|--------------|------------------|-----------------------|------------------|
| GA342D1XGF100JY02L | AC250 (r.m.s.) | SL (JIS) | 10 ±5% | 4.5 | 2.0 | 2.0 | 2.5 | 0.3 min. |
| GA342D1XGF120JY02L | AC250 (r.m.s.) | SL (JIS) | 12 ±5% | 4.5 | 2.0 | 2.0 | 2.5 | 0.3 min. |
| GA342D1XGF150JY02L | AC250 (r.m.s.) | SL (JIS) | 15 ±5% | 4.5 | 2.0 | 2.0 | 2.5 | 0.3 min. |
| GA342D1XGF180JY02L | AC250 (r.m.s.) | SL (JIS) | 18 ±5% | 4.5 | 2.0 | 2.0 | 2.5 | 0.3 min. |
| GA342D1XGF220JY02L | AC250 (r.m.s.) | SL (JIS) | 22 ±5% | 4.5 | 2.0 | 2.0 | 2.5 | 0.3 min. |
| GA342A1XGF270JW31L | AC250 (r.m.s.) | SL (JIS) | 27 ±5% | 4.5 | 2.0 | 1.0 | 2.5 | 0.3 min. |
| GA342A1XGF330JW31L | AC250 (r.m.s.) | SL (JIS) | 33 ±5% | 4.5 | 2.0 | 1.0 | 2.5 | 0.3 min. |
| GA342A1XGF390JW31L | AC250 (r.m.s.) | SL (JIS) | 39 ±5% | 4.5 | 2.0 | 1.0 | 2.5 | 0.3 min. |
| GA342A1XGF470JW31L | AC250 (r.m.s.) | SL (JIS) | 47 ±5% | 4.5 | 2.0 | 1.0 | 2.5 | 0.3 min. |
| GA342A1XGF560JW31L | AC250 (r.m.s.) | SL (JIS) | 56 ±5% | 4.5 | 2.0 | 1.0 | 2.5 | 0.3 min. |
| GA342A1XGF680JW31L | AC250 (r.m.s.) | SL (JIS) | 68 ±5% | 4.5 | 2.0 | 1.0 | 2.5 | 0.3 min. |
| GA342A1XGF820JW31L | AC250 (r.m.s.) | SL (JIS) | 82 ±5% | 4.5 | 2.0 | 1.0 | 2.5 | 0.3 min. |
| GA342QR7GF101KW01L | AC250 (r.m.s.) | X7R (EIA) | 100 ±10% | 4.5 | 2.0 | 1.5 | 2.5 | 0.3 min. |
| GA342QR7GF151KW01L | AC250 (r.m.s.) | X7R (EIA) | 150 ±10% | 4.5 | 2.0 | 1.5 | 2.5 | 0.3 min. |
| GA342DR7GF221KW02L | AC250 (r.m.s.) | X7R (EIA) | 220 ±10% | 4.5 | 2.0 | 2.0 | 2.5 | 0.3 min. |
| GA342DR7GF331KW02L | AC250 (r.m.s.) | X7R (EIA) | 330 ±10% | 4.5 | 2.0 | 2.0 | 2.5 | 0.3 min. |
| GA342QR7GF471KW01L | AC250 (r.m.s.) | X7R (EIA) | 470 ±10% | 4.5 | 2.0 | 1.5 | 2.5 | 0.3 min. |
| GA352QR7GF471KW01L | AC250 (r.m.s.) | X7R (EIA) | 470 ±10% | 5.7 | 2.8 | 1.5 | 4.0 | 0.3 min. |
| GA342QR7GF681KW01L | AC250 (r.m.s.) | X7R (EIA) | 680 ±10% | 4.5 | 2.0 | 1.5 | 2.5 | 0.3 min. |
| GA352QR7GF681KW01L | AC250 (r.m.s.) | X7R (EIA) | 680 ±10% | 5.7 | 2.8 | 1.5 | 4.0 | 0.3 min. |
| GA342DR7GF102KW02L | AC250 (r.m.s.) | X7R (EIA) | 1000 ±10% | 4.5 | 2.0 | 2.0 | 2.5 | 0.3 min. |
| GA352QR7GF102KW01L | AC250 (r.m.s.) | X7R (EIA) | 1000 ±10% | 5.7 | 2.8 | 1.5 | 4.0 | 0.3 min. |

Continued on the following page. ↗



• This PDF catalog has only typical specifications because there is no space for detailed specifications. Therefore, please approve our product specifications or transact the approval sheet for product specifications before ordering.

Continued from the preceding page.

| Part Number | Rated Voltage (V) | TC Code (Standard) | Capacitance (pF) | Length L (mm) | Width W (mm) | Thickness T (mm) | Electrode g min. (mm) | Electrode e (mm) |
|---------------------------|-------------------|--------------------|------------------|---------------|--------------|------------------|-----------------------|------------------|
| GA352QR7GF152KW01L | AC250 (r.m.s.) | X7R (EIA) | 1500 ±10% | 5.7 | 2.8 | 1.5 | 4.0 | 0.3 min. |
| GA355QR7GF182KW01L | AC250 (r.m.s.) | X7R (EIA) | 1800 ±10% | 5.7 | 5.0 | 1.5 | 4.0 | 0.3 min. |
| GA355QR7GF222KW01L | AC250 (r.m.s.) | X7R (EIA) | 2200 ±10% | 5.7 | 5.0 | 1.5 | 4.0 | 0.3 min. |
| GA355QR7GF332KW01L | AC250 (r.m.s.) | X7R (EIA) | 3300 ±10% | 5.7 | 5.0 | 1.5 | 4.0 | 0.3 min. |
| GA355DR7GF472KW01L | AC250 (r.m.s.) | X7R (EIA) | 4700 ±10% | 5.7 | 5.0 | 2.0 | 4.0 | 0.3 min. |

For General Purpose
GRM/GRJ Series

Only for Applications

AC250V Type
GA2 Series

Safety Standard
Certified GA3 Series

Product Information

Chip Monolithic Ceramic Capacitors



Safety Standard Certified GA3 Series IEC60384-14 Class Y3 Type GD

■ Features

1. Available for equipment based on IEC/EN60950 and UL1950.
2. Type GD can be used as a Y3-class capacitor.
3. A new monolithic structure for small, high capacitance capable of operating at high voltage levels.
4. +125 degree C guaranteed
5. Only for reflow soldering

■ Applications

1. Ideal for use on line filters and couplings for DAA modems without transformers
2. Ideal for use on line filters for information equipment

Do not use these products in any Automotive Power train or Safety equipment including Battery chargers for Electric Vehicles and Plug-in Hybrids. Only Murata products clearly stipulated as "for Automotive use" can be used for automobile applications such as Power train and Safety equipment.

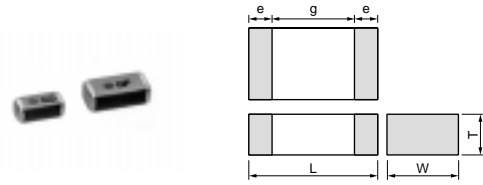

| Part Number | Dimensions (mm) | | | | |
|-------------|-----------------|----------|--------------|--------|--------|
| | L | W | T | e min. | g min. |
| GA342A | 4.5 ±0.3 | 2.0 ±0.2 | 1.0 +0, -0.3 | 0.3 | 2.5 |
| GA342D | | | 2.0 ±0.2 | | |
| GA342Q | | | 1.5 +0, -0.3 | | |
| GA343D | 4.5 ±0.4 | 3.2 ±0.3 | 2.0 +0, -0.3 | | |
| GA343Q | | | 1.5 +0, -0.3 | | |

■ Standard Certification

| | Standard No. | Class | Rated Voltage |
|-------|-----------------------------|-------|----------------|
| UL | UL 60950-1 | Y3 | AC250V(r.m.s.) |
| SEMKO | IEC 60384-14 EN 60384-14 | | |

Applications

| Size | Switching power supplies | Communication network devices such as a modem |
|---------------------|--------------------------|---|
| 4.5×3.2mm and under | — | ◎ |

| Part Number | Rated Voltage (V) | TC Code (Standard) | Capacitance (pF) | Length L (mm) | Width W (mm) | Thickness T (mm) | Electrode g min. (mm) | Electrode e (mm) |
|--------------------|-------------------|--------------------|------------------|---------------|--------------|------------------|-----------------------|------------------|
| GA342D1XGD100JY02L | AC250 (r.m.s.) | SL (JIS) | 10 ±5% | 4.5 | 2.0 | 2.0 | 2.5 | 0.3 min. |
| GA342D1XGD120JY02L | AC250 (r.m.s.) | SL (JIS) | 12 ±5% | 4.5 | 2.0 | 2.0 | 2.5 | 0.3 min. |
| GA342D1XGD150JY02L | AC250 (r.m.s.) | SL (JIS) | 15 ±5% | 4.5 | 2.0 | 2.0 | 2.5 | 0.3 min. |
| GA342D1XGD180JY02L | AC250 (r.m.s.) | SL (JIS) | 18 ±5% | 4.5 | 2.0 | 2.0 | 2.5 | 0.3 min. |
| GA342D1XGD220JY02L | AC250 (r.m.s.) | SL (JIS) | 22 ±5% | 4.5 | 2.0 | 2.0 | 2.5 | 0.3 min. |
| GA342A1XGD270JW31L | AC250 (r.m.s.) | SL (JIS) | 27 ±5% | 4.5 | 2.0 | 1.0 | 2.5 | 0.3 min. |
| GA342A1XGD330JW31L | AC250 (r.m.s.) | SL (JIS) | 33 ±5% | 4.5 | 2.0 | 1.0 | 2.5 | 0.3 min. |
| GA342A1XGD390JW31L | AC250 (r.m.s.) | SL (JIS) | 39 ±5% | 4.5 | 2.0 | 1.0 | 2.5 | 0.3 min. |
| GA342A1XGD470JW31L | AC250 (r.m.s.) | SL (JIS) | 47 ±5% | 4.5 | 2.0 | 1.0 | 2.5 | 0.3 min. |
| GA342A1XGD560JW31L | AC250 (r.m.s.) | SL (JIS) | 56 ±5% | 4.5 | 2.0 | 1.0 | 2.5 | 0.3 min. |
| GA342A1XGD680JW31L | AC250 (r.m.s.) | SL (JIS) | 68 ±5% | 4.5 | 2.0 | 1.0 | 2.5 | 0.3 min. |
| GA342A1XGD820JW31L | AC250 (r.m.s.) | SL (JIS) | 82 ±5% | 4.5 | 2.0 | 1.0 | 2.5 | 0.3 min. |
| GA342QR7GD101KW01L | AC250 (r.m.s.) | X7R (EIA) | 100 ±10% | 4.5 | 2.0 | 1.5 | 2.5 | 0.3 min. |
| GA342QR7GD151KW01L | AC250 (r.m.s.) | X7R (EIA) | 150 ±10% | 4.5 | 2.0 | 1.5 | 2.5 | 0.3 min. |
| GA342QR7GD221KW01L | AC250 (r.m.s.) | X7R (EIA) | 220 ±10% | 4.5 | 2.0 | 1.5 | 2.5 | 0.3 min. |
| GA342QR7GD331KW01L | AC250 (r.m.s.) | X7R (EIA) | 330 ±10% | 4.5 | 2.0 | 1.5 | 2.5 | 0.3 min. |
| GA342QR7GD471KW01L | AC250 (r.m.s.) | X7R (EIA) | 470 ±10% | 4.5 | 2.0 | 1.5 | 2.5 | 0.3 min. |
| GA342QR7GD681KW01L | AC250 (r.m.s.) | X7R (EIA) | 680 ±10% | 4.5 | 2.0 | 1.5 | 2.5 | 0.3 min. |
| GA342QR7GD102KW01L | AC250 (r.m.s.) | X7R (EIA) | 1000 ±10% | 4.5 | 2.0 | 1.5 | 2.5 | 0.3 min. |
| GA342QR7GD152KW01L | AC250 (r.m.s.) | X7R (EIA) | 1500 ±10% | 4.5 | 2.0 | 1.5 | 2.5 | 0.3 min. |
| GA343QR7GD182KW01L | AC250 (r.m.s.) | X7R (EIA) | 1800 ±10% | 4.5 | 3.2 | 1.5 | 2.5 | 0.3 min. |
| GA343QR7GD222KW01L | AC250 (r.m.s.) | X7R (EIA) | 2200 ±10% | 4.5 | 3.2 | 1.5 | 2.5 | 0.3 min. |
| GA343DR7GD472KW01L | AC250 (r.m.s.) | X7R (EIA) | 4700 ±10% | 4.5 | 3.2 | 2.0 | 2.5 | 0.3 min. |

Chip Monolithic Ceramic Capacitors



Safety Standard Certified GA3 Series IEC60384-14 Class X2 Type GB

■ Features

1. Type GB can be used as an X2-class capacitor.
2. Chip monolithic ceramic capacitor (certified as conforming to safety standards) for AC lines.
3. A new monolithic structure for small, high capacitance capable of operating at high voltage levels.
4. Compared to lead type capacitors, this new capacitor is greatly downsized and low-profiled to 1/10 or less in volume, and 1/4 or less in height.
5. +125 degree C guaranteed
6. Only for reflow soldering

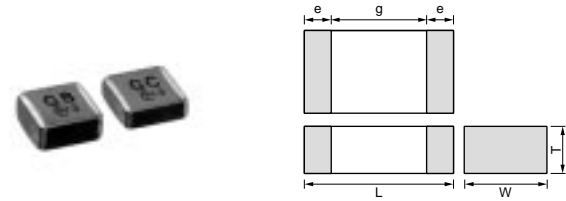

| Part Number | Dimensions (mm) | | | | |
|-------------|-----------------|----------|-------------|--------|--------|
| | L | W | T | e min. | g min. |
| GA355Q | 5.7 ±0.4 | 5.0 ±0.4 | 1.5 +0,-0.3 | 0.3 | 3.0 |
| GA355D | | | 2.0 +0,-0.3 | | |
| GA355E | | | 2.5 +0,-0.3 | | |
| GA355X | | | 2.9 +0,-0.4 | | |

■ Applications

Ideal for use as X capacitor for various switching power supplies

Do not use these products in any Automotive Power train or Safety equipment including Battery chargers for Electric Vehicles and Plug-in Hybrids. Only Murata products clearly stipulated as "for Automotive use" can be used for automobile applications such as Power train and Safety equipment.

■ Standard Certification

| | Standard No. | Class | Rated Voltage |
|-------|-----------------------------|-------|--------------------|
| VDE | IEC 60384-14 EN 60384-14 | X2 | AC250V (r.m.s.) |
| SEMKO | | | |
| ESTI | | | |

| Part Number | Rated Voltage (V) | TC Code (Standard) | Capacitance (pF) | Length L (mm) | Width W (mm) | Thickness T (mm) | Electrode g min. (mm) | Electrode e (mm) |
|--------------------|-------------------|--------------------|------------------|---------------|--------------|------------------|-----------------------|------------------|
| GA355QR7GB103KW01L | AC250 (r.m.s.) | X7R (EIA) | 10000 ±10% | 5.7 | 5.0 | 1.5 | 3.0 | 0.3 min. |
| GA355QR7GB153KW01L | AC250 (r.m.s.) | X7R (EIA) | 15000 ±10% | 5.7 | 5.0 | 1.5 | 3.0 | 0.3 min. |
| GA355DR7GB223KW01L | AC250 (r.m.s.) | X7R (EIA) | 22000 ±10% | 5.7 | 5.0 | 2.0 | 3.0 | 0.3 min. |
| GA355ER7GB333KW01L | AC250 (r.m.s.) | X7R (EIA) | 33000 ±10% | 5.7 | 5.0 | 2.5 | 3.0 | 0.3 min. |
| GA355ER7GB473KW01L | AC250 (r.m.s.) | X7R (EIA) | 47000 ±10% | 5.7 | 5.0 | 2.5 | 3.0 | 0.3 min. |
| GA355XR7GB563KW06L | AC250 (r.m.s.) | X7R (EIA) | 56000 ±10% | 5.7 | 5.0 | 2.9 | 3.0 | 0.3 min. |

For General Purpose GRM/GRJ Series

Only for Applications

AC250V Type GA2 Series

Safety Standard Certified GA3 Series

Product Information

GA3 Series Specifications and Test Methods

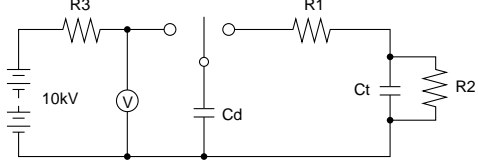
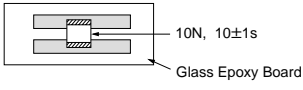
| No. | Item | Specifications | Test Method | | | | | | | | | | | | | | | | | | | | |
|------------|---|---|---|--------------------|--------------|--------------|---------|--------------------------|---------------------|--|---|------|------------------|---|--------------------------|---|------------------------|---|--------------------------|---|------------------------|---|--------------------------|
| 1 | Operating Temperature Range | -55 to +125°C | - | | | | | | | | | | | | | | | | | | | | |
| 2 | Appearance | No defects or abnormalities | Visual inspection | | | | | | | | | | | | | | | | | | | | |
| 3 | Dimensions | Within the specified dimensions | Using calipers and micrometers | | | | | | | | | | | | | | | | | | | | |
| 4 | Dielectric Strength | No defects or abnormalities | No failure should be observed when voltage in the table is applied between the terminations for 60±1 sec., provided the charge/discharge current is less than 50mA. <table border="1"> <thead> <tr> <th></th> <th>Test Voltage</th> </tr> </thead> <tbody> <tr> <td>Type GB</td> <td>DC1075V</td> </tr> <tr> <td>Type GC/GD</td> <td>AC1500V (r.m.s.)</td> </tr> <tr> <td>Type GF</td> <td>AC2000V (r.m.s.)</td> </tr> </tbody> </table> | | Test Voltage | Type GB | DC1075V | Type GC/GD | AC1500V (r.m.s.) | Type GF | AC2000V (r.m.s.) | | | | | | | | | | | | |
| | Test Voltage | | | | | | | | | | | | | | | | | | | | | | |
| Type GB | DC1075V | | | | | | | | | | | | | | | | | | | | | | |
| Type GC/GD | AC1500V (r.m.s.) | | | | | | | | | | | | | | | | | | | | | | |
| Type GF | AC2000V (r.m.s.) | | | | | | | | | | | | | | | | | | | | | | |
| 5 | Pulse Voltage (Application: Type GD/GF) | No self healing breakdowns or flash-overs have taken place in the capacitor. | 10 impulses of alternating polarity are subjected. (5 impulses for each polarity) The interval between impulses is 60 sec. Applied Pulse: 1.2/50µs Applied Voltage: 2.5kVo-p | | | | | | | | | | | | | | | | | | | | |
| 6 | Insulation Resistance (I.R.) | More than 6,000MΩ | The insulation resistance should be measured with DC500±50V and within 60±5 sec. of charging. | | | | | | | | | | | | | | | | | | | | |
| 7 | Capacitance | Within the specified tolerance | | | | | | | | | | | | | | | | | | | | | |
| 8 | Dissipation Factor (D.F.) Q | <table border="1"> <thead> <tr> <th>Char.</th> <th>Specification</th> </tr> </thead> <tbody> <tr> <td>X7R</td> <td>D.F. ≤ 0.025</td> </tr> <tr> <td rowspan="2">SL</td> <td>Q ≥ 400+20C*2 (C < 30pF)</td> </tr> <tr> <td>Q ≥ 1000 (C ≥ 30pF)</td> </tr> </tbody> </table> | Char. | Specification | X7R | D.F. ≤ 0.025 | SL | Q ≥ 400+20C*2 (C < 30pF) | Q ≥ 1000 (C ≥ 30pF) | The capacitance/Q/D.F. should be measured at a frequency of 1±0.2kHz (SL char.: 1±0.2MHz) and a voltage of AC1±0.2V (r.m.s.) | | | | | | | | | | | | | |
| Char. | Specification | | | | | | | | | | | | | | | | | | | | | | |
| X7R | D.F. ≤ 0.025 | | | | | | | | | | | | | | | | | | | | | | |
| SL | Q ≥ 400+20C*2 (C < 30pF) | | | | | | | | | | | | | | | | | | | | | | |
| | Q ≥ 1000 (C ≥ 30pF) | | | | | | | | | | | | | | | | | | | | | | |
| 9 | Capacitance Temperature Characteristics | <table border="1"> <thead> <tr> <th>Char.</th> <th>Capacitance Change</th> </tr> </thead> <tbody> <tr> <td>X7R</td> <td>Within ±15%</td> </tr> </tbody> </table> Temperature characteristic guarantee is -55 to +125°C <table border="1"> <thead> <tr> <th>Char.</th> <th>Temperature Coefficient</th> </tr> </thead> <tbody> <tr> <td>SL</td> <td>+350 to -1000ppm/°C</td> </tr> </tbody> </table> Temperature characteristic guarantee is +20 to +85°C | Char. | Capacitance Change | X7R | Within ±15% | Char. | Temperature Coefficient | SL | +350 to -1000ppm/°C | The capacitance measurement should be made at each step specified in the Table. <table border="1"> <thead> <tr> <th>Step</th> <th>Temperature (°C)</th> </tr> </thead> <tbody> <tr> <td>1</td> <td>25±2 (20±2 for SL char.)</td> </tr> <tr> <td>2</td> <td>Min. Operating Temp.±3</td> </tr> <tr> <td>3</td> <td>25±2 (20±2 for SL char.)</td> </tr> <tr> <td>4</td> <td>Max. Operating Temp.±2</td> </tr> <tr> <td>5</td> <td>25±2 (20±2 for SL char.)</td> </tr> </tbody> </table> SL char. : The capacitance should be measured at even 85°C between step 3 and step 4. •Pretreatment for X7R char. Perform a heat treatment at 150±18°C for 60±5 min. and then let sit for 24±2 hrs. at room condition.*1 | Step | Temperature (°C) | 1 | 25±2 (20±2 for SL char.) | 2 | Min. Operating Temp.±3 | 3 | 25±2 (20±2 for SL char.) | 4 | Max. Operating Temp.±2 | 5 | 25±2 (20±2 for SL char.) |
| Char. | Capacitance Change | | | | | | | | | | | | | | | | | | | | | | |
| X7R | Within ±15% | | | | | | | | | | | | | | | | | | | | | | |
| Char. | Temperature Coefficient | | | | | | | | | | | | | | | | | | | | | | |
| SL | +350 to -1000ppm/°C | | | | | | | | | | | | | | | | | | | | | | |
| Step | Temperature (°C) | | | | | | | | | | | | | | | | | | | | | | |
| 1 | 25±2 (20±2 for SL char.) | | | | | | | | | | | | | | | | | | | | | | |
| 2 | Min. Operating Temp.±3 | | | | | | | | | | | | | | | | | | | | | | |
| 3 | 25±2 (20±2 for SL char.) | | | | | | | | | | | | | | | | | | | | | | |
| 4 | Max. Operating Temp.±2 | | | | | | | | | | | | | | | | | | | | | | |
| 5 | 25±2 (20±2 for SL char.) | | | | | | | | | | | | | | | | | | | | | | |
| 10 | Appearance | No defects or abnormalities | As in Fig., discharge is made 50 times at 5 sec. intervals from the capacitor (Cd) charged at DC voltage of specified.  Ct: Capacitor under test Cd: 0.001µF R1: 1,000Ω R2: 100MΩ R3: Surge resistance | | | | | | | | | | | | | | | | | | | | |
| | I.R. | More than 1,000MΩ | | | | | | | | | | | | | | | | | | | | | |
| | Dielectric Strength | In accordance with item No.4 | | | | | | | | | | | | | | | | | | | | | |
| 11 | Adhesive Strength of Termination | No removal of the terminations or other defect should occur. | Solder the capacitor to the testing jig (glass epoxy board) shown in Fig. 1. Then apply 10N force in the direction of the arrow. The soldering should be done using the reflow method and should be conducted with care so that the soldering is uniform and free of defects such as heat shock.  Fig. 1 | | | | | | | | | | | | | | | | | | | | |

*1 "Room condition" Temperature: 15 to 35°C, Relative humidity: 45 to 75%, Atmospheric pressure: 86 to 106kPa

*2 "C" expresses nominal capacitance value (pF).

Continued on the following page. ↗

GA3 Series Specifications and Test Methods

Continued from the preceding page.

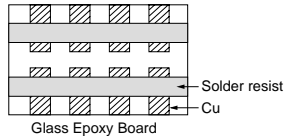
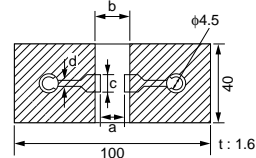
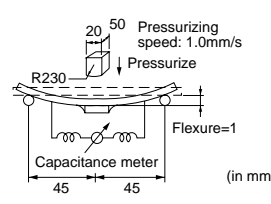
| No. | Item | Specifications | Test Method | | | | | | | | | | | | | | | | | | | | | | | | |
|----------|---|---|--|---------------|----------------|--------------|----|---|---|---|--------------|--------|---|---------|-----|-----|-----|-----|---------|-----|-----|-----|---------|-----|-----|-----|---------|
| 12 | Vibration Resistance | Appearance | Solder the capacitor to the test jig (glass epoxy board). The capacitor should be subjected to a simple harmonic motion having a total amplitude of 1.5mm, the frequency being varied uniformly between the approximate limits of 10 and 55Hz. The frequency range, from 10 to 55Hz and return to 10Hz, should be traversed in approximately 1 min. This motion should be applied for a period of 2 hrs. in each of 3 mutually perpendicular directions (total of 6 hrs.). | | | | | | | | | | | | | | | | | | | | | | | | |
| | | Capacitance | | | | | | | | | | | | | | | | | | | | | | | | | |
| | D.F. | <table border="1" style="width: 100%; border-collapse: collapse;"> <thead> <tr> <th>Char.</th> <th>Specification</th> </tr> </thead> <tbody> <tr> <td>X7R</td> <td>D.F. ≤ 0.025</td> </tr> <tr> <td>SL</td> <td>Q ≥ 400 + 20C*2 (C < 30pF) Q ≥ 1000 (C ≥ 30pF)</td> </tr> </tbody> </table> | Char. | Specification | X7R | D.F. ≤ 0.025 | SL | Q ≥ 400 + 20C*2 (C < 30pF) Q ≥ 1000 (C ≥ 30pF) |  | | | | | | | | | | | | | | | | | | |
| Char. | Specification | | | | | | | | | | | | | | | | | | | | | | | | | | |
| X7R | D.F. ≤ 0.025 | | | | | | | | | | | | | | | | | | | | | | | | | | |
| SL | Q ≥ 400 + 20C*2 (C < 30pF) Q ≥ 1000 (C ≥ 30pF) | | | | | | | | | | | | | | | | | | | | | | | | | | |
| | Q | | | | | | | | | | | | | | | | | | | | | | | | | | |
| 13 | Deflection | No marking defects | Solder the capacitor to the testing jig (glass epoxy board) shown in Fig. 2. Then apply a force in the direction shown in Fig. 3. The soldering should be done using the reflow method and should be conducted with care so that the soldering is uniform and free of defects such as heat shock. | | | | | | | | | | | | | | | | | | | | | | | | |
| | |  Fig. 2 <table border="1" style="width: 100%; border-collapse: collapse; margin-top: 10px;"> <thead> <tr> <th rowspan="2">LxW (mm)</th> <th colspan="4">Dimension (mm)</th> <th rowspan="2">t</th> </tr> <tr> <th>a</th> <th>b</th> <th>c</th> <th>d</th> </tr> </thead> <tbody> <tr> <td>4.5x2.0</td> <td>3.5</td> <td>7.0</td> <td>2.4</td> <td rowspan="4" style="text-align: center;">1.0</td> </tr> <tr> <td>4.5x3.2</td> <td>3.5</td> <td>7.0</td> <td>3.7</td> </tr> <tr> <td>5.7x2.8</td> <td>4.5</td> <td>8.0</td> <td>3.2</td> </tr> <tr> <td>5.7x5.0</td> <td>4.5</td> <td>8.0</td> <td>5.6</td> </tr> </tbody> </table> | | LxW (mm) | Dimension (mm) | | | | t | a | b | c | d | 4.5x2.0 | 3.5 | 7.0 | 2.4 | 1.0 | 4.5x3.2 | 3.5 | 7.0 | 3.7 | 5.7x2.8 | 4.5 | 8.0 | 3.2 | 5.7x5.0 |
| LxW (mm) | Dimension (mm) | | | | t | | | | | | | | | | | | | | | | | | | | | | |
| | a | b | c | d | | | | | | | | | | | | | | | | | | | | | | | |
| 4.5x2.0 | 3.5 | 7.0 | 2.4 | 1.0 | | | | | | | | | | | | | | | | | | | | | | | |
| 4.5x3.2 | 3.5 | 7.0 | 3.7 | | | | | | | | | | | | | | | | | | | | | | | | |
| 5.7x2.8 | 4.5 | 8.0 | 3.2 | | | | | | | | | | | | | | | | | | | | | | | | |
| 5.7x5.0 | 4.5 | 8.0 | 5.6 | | | | | | | | | | | | | | | | | | | | | | | | |
| | | |  Fig. 3 <p style="text-align: right;">(in mm)</p> | | | | | | | | | | | | | | | | | | | | | | | | |
| 14 | Solderability of Termination | 75% of the terminations are to be soldered evenly and continuously. | Immerse the capacitor in a solution of ethanol (JIS-K-8101) and rosin (JIS-K-5902) (25% rosin in weight proportion). Immerse in solder solution for 2±0.5 sec. Immersing speed: 25±2.5mm/s Temp. of solder: 245±5°C Lead Free Solder (Sn-3.0Ag-0.5Cu) 235±5°C H60A or H63A Eutectic Solder | | | | | | | | | | | | | | | | | | | | | | | | |
| 15 | Resistance to Soldering Heat | Appearance | Preheat the capacitor as in table. Immerse the capacitor in solder solution at 260±5°C for 10±1 sec. Let sit at room condition*1 for 24±2 hrs., then measure. •Immersing speed: 25±2.5mm/s •Pretreatment for X7R char. Perform a heat treatment at 150±10°C for 60±5 min. and then let sit for 24±2 hrs. at room condition.*1 | | | | | | | | | | | | | | | | | | | | | | | | |
| | | Capacitance Change | | | | | | | | | | | | | | | | | | | | | | | | | |
| | | I.R. | | | | | | | | | | | | | | | | | | | | | | | | | |
| | | Dielectric Strength | | | | | | | | | | | | | | | | | | | | | | | | | |
| | | In accordance with item No.4 | *Preheating <table border="1" style="width: 100%; border-collapse: collapse; margin-top: 5px;"> <thead> <tr> <th>Step</th> <th>Temperature</th> <th>Time</th> </tr> </thead> <tbody> <tr> <td>1</td> <td>100 to 120°C</td> <td>1 min.</td> </tr> <tr> <td>2</td> <td>170 to 200°C</td> <td>1 min.</td> </tr> </tbody> </table> | Step | Temperature | Time | 1 | 100 to 120°C | 1 min. | 2 | 170 to 200°C | 1 min. | | | | | | | | | | | | | | | |
| Step | Temperature | Time | | | | | | | | | | | | | | | | | | | | | | | | | |
| 1 | 100 to 120°C | 1 min. | | | | | | | | | | | | | | | | | | | | | | | | | |
| 2 | 170 to 200°C | 1 min. | | | | | | | | | | | | | | | | | | | | | | | | | |

*1 "Room condition" Temperature: 15 to 35°C, Relative humidity: 45 to 75%, Atmospheric pressure: 86 to 106kPa
 *2 "C" expresses nominal capacitance value (pF).

Continued on the following page.

For General Purpose GRM/GRJ Series

Only for Applications

AC250V Type GA2 Series

Safety Standard Certified GA3 Series

Product Information

GA3 Series Specifications and Test Methods

Continued from the preceding page.

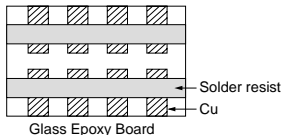
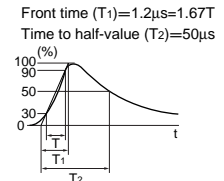
| No. | Item | Specifications | Test Method | | | | | | | | | | | | | | | |
|---------------------|--|--|---|--------------------|------------------|-------------|--|------------------------|--|----|------------|--------|---|------------------------|------|---|------------|--------|
| 16 | Appearance | No marking defects | Fix the capacitor to the supporting jig (glass epoxy board) shown in Fig. 4. Perform the 5 cycles according to the 4 heat treatments listed in the following table. Let sit for 24±2 hrs. at room condition,*1 then measure. <table border="1" style="margin: 10px auto;"> <thead> <tr> <th>Step</th> <th>Temperature (°C)</th> <th>Time (min.)</th> </tr> </thead> <tbody> <tr> <td>1</td> <td>Min. Operating Temp.±3</td> <td>30±3</td> </tr> <tr> <td>2</td> <td>Room Temp.</td> <td>2 to 3</td> </tr> <tr> <td>3</td> <td>Max. Operating Temp.±2</td> <td>30±3</td> </tr> <tr> <td>4</td> <td>Room Temp.</td> <td>2 to 3</td> </tr> </tbody> </table> •Pretreatment for X7R char. Perform a heat treatment at 150±1,8°C for 60±5 min. and then let sit for 24±2 hrs. at room condition.*1 <div style="text-align: center; margin: 10px 0;">  <p>Fig. 4</p> </div> | Step | Temperature (°C) | Time (min.) | 1 | Min. Operating Temp.±3 | 30±3 | 2 | Room Temp. | 2 to 3 | 3 | Max. Operating Temp.±2 | 30±3 | 4 | Room Temp. | 2 to 3 |
| | Step | Temperature (°C) | | Time (min.) | | | | | | | | | | | | | | |
| | 1 | Min. Operating Temp.±3 | | 30±3 | | | | | | | | | | | | | | |
| | 2 | Room Temp. | | 2 to 3 | | | | | | | | | | | | | | |
| | 3 | Max. Operating Temp.±2 | | 30±3 | | | | | | | | | | | | | | |
| 4 | Room Temp. | 2 to 3 | | | | | | | | | | | | | | | | |
| Capacitance Change | Char. | Capacitance Change | | | | | | | | | | | | | | | | |
| | X7R | Within ±15% | | | | | | | | | | | | | | | | |
| SL | Within ±2.5% or ±0.25pF (Whichever is larger) | | | | | | | | | | | | | | | | | |
| D.F. Q | Char. | Specification | | | | | | | | | | | | | | | | |
| | X7R | D.F.≤0.05 | | | | | | | | | | | | | | | | |
| SL | Q≥400+20C*2 (C<30pF) Q≥1000 (C≥30pF) | | | | | | | | | | | | | | | | | |
| I.R. | More than 3,000MΩ | | | | | | | | | | | | | | | | | |
| Dielectric Strength | In accordance with item No.4 | | | | | | | | | | | | | | | | | |
| 17 | Appearance | No marking defects | Before this test, the test shown in the following is performed. -Item 11 Adhesive Strength of Termination (applied force is 5N) -Item 13 Deflection Let the capacitor sit at 40±2°C and relative humidity of 90 to 95% for 500 ⁺²⁴ hrs. Remove and let sit for 24±2 hrs. at room condition,*1 then measure. •Pretreatment for X7R char. Perform a heat treatment at 150±1,8°C for 60±5 min. and then let sit for 24±2 hrs. at room condition.*1 | | | | | | | | | | | | | | | |
| | Capacitance Change | Char. | | Capacitance Change | | | | | | | | | | | | | | |
| | | X7R | | Within ±15% | | | | | | | | | | | | | | |
| | SL | Within ±5.0% or ±0.5pF (Whichever is larger) | | | | | | | | | | | | | | | | |
| | D.F. Q | Char. | | Specification | | | | | | | | | | | | | | |
| X7R | | D.F.≤0.05 | | | | | | | | | | | | | | | | |
| SL | Q≥275+5/2C*2 (C<30pF) Q≥350 (C≥30pF) | | | | | | | | | | | | | | | | | |
| I.R. | More than 3,000MΩ | | | | | | | | | | | | | | | | | |
| Dielectric Strength | In accordance with item No.4 | | | | | | | | | | | | | | | | | |
| 18 | Appearance | No marking defects | Before this test, the test shown in the following is performed. -Item 11 Adhesive Strength of Termination (apply force is 5N) -Item 13 Deflection Impulse Voltage Each individual capacitor should be subjected to a 2.5kV (Type GC/GF: 5kV) Impulse (the voltage value means zero to peak) for three times. Then the capacitors are applied to life test. <div style="text-align: right; margin: 10px 0;">  <p>Front time (T1)=1.2μs=1.67T Time to half-value (T2)=50μs</p> </div> | | | | | | | | | | | | | | | |
| | Capacitance Change | Char. | | Capacitance Change | | | | | | | | | | | | | | |
| | | X7R | | Within ±20% | | | | | | | | | | | | | | |
| | SL | Within ±3.0% or ±0.3pF (Whichever is larger) | | | | | | | | | | | | | | | | |
| | D.F. Q | Char. | | Specification | | | | | | | | | | | | | | |
| X7R | | D.F.≤0.05 | | | | | | | | | | | | | | | | |
| SL | Q≥275+5/2C*2 (C<30pF) Q≥350 (C≥30pF) | | | | | | | | | | | | | | | | | |
| I.R. | More than 3,000MΩ | | | | | | | | | | | | | | | | | |
| Dielectric Strength | In accordance with item No.4 | | | | | | | | | | | | | | | | | |
| 18 | Life | I.R. | More than 3,000MΩ | | | | | | | | | | | | | | | |
| | | Dielectric Strength | In accordance with item No.4 | | | | | | | | | | | | | | | |
| | | | Apply voltage as in Table for 1,000 hrs. at 125±2,8°C, relative humidity 50% max. <table border="1" style="margin: 10px auto;"> <thead> <tr> <th>Type</th> <th>Applied Voltage</th> </tr> </thead> <tbody> <tr> <td>GB</td> <td>AC312.5V (r.m.s.), except that once each hour the voltage is increased to AC1,000V (r.m.s.) for 0.1 sec.</td> </tr> <tr> <td>GC</td> <td rowspan="3">AC425V (r.m.s.), except that once each hour the voltage is increased to AC1,000V (r.m.s.) for 0.1 sec.</td> </tr> <tr> <td>GF</td> </tr> <tr> <td>GD</td> </tr> </tbody> </table> Let sit for 24±2 hrs. at room condition,*1 then measure. •Pretreatment for X7R char. Perform a heat treatment at 150±1,8°C for 60±5 min. and then let sit for 24±2 hrs. at room condition.*1 | Type | Applied Voltage | GB | AC312.5V (r.m.s.), except that once each hour the voltage is increased to AC1,000V (r.m.s.) for 0.1 sec. | GC | AC425V (r.m.s.), except that once each hour the voltage is increased to AC1,000V (r.m.s.) for 0.1 sec. | GF | GD | | | | | | | |
| Type | Applied Voltage | | | | | | | | | | | | | | | | | |
| GB | AC312.5V (r.m.s.), except that once each hour the voltage is increased to AC1,000V (r.m.s.) for 0.1 sec. | | | | | | | | | | | | | | | | | |
| GC | AC425V (r.m.s.), except that once each hour the voltage is increased to AC1,000V (r.m.s.) for 0.1 sec. | | | | | | | | | | | | | | | | | |
| GF | | | | | | | | | | | | | | | | | | |
| GD | | | | | | | | | | | | | | | | | | |

*1 "Room condition" Temperature: 15 to 35°C, Relative humidity: 45 to 75%, Atmospheric pressure: 86 to 106kPa

*2 "C" expresses nominal capacitance value (pF).

Continued on the following page.

GA3 Series Specifications and Test Methods

Continued from the preceding page.

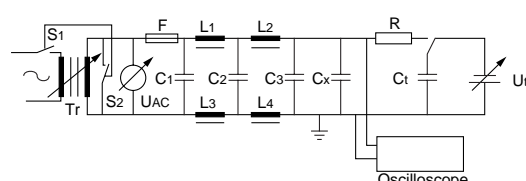
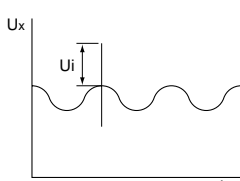
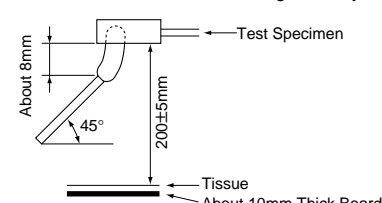
| No. | Item | Specifications | Test Method | | | | | | | | | | | | | | |
|--|---|------------------------------|---|--|--|----------------|----------------------|--|--|------------------|-------------|---------------------------|-------------|---------------------|--------------------|--|----------------------------|
| 19 | Humidity Loading | Appearance | No marking defects | | | | | | | | | | | | | | |
| | | Capacitance Change | Char. | Capacitance Change | | | | | | | | | | | | | |
| | | | X7R | Within ±15% | | | | | | | | | | | | | |
| | | D.F. Q | SL | Within ±5.0% or ±0.5pF (Whichever is larger) | | | | | | | | | | | | | |
| | | | Char. | Specification | | | | | | | | | | | | | |
| X7R | D.F. ≤0.05 | | | | | | | | | | | | | | | | |
| SL | Q ≥ 275 + 5/2C ^{*2} (C < 30pF) Q ≥ 350 (C ≥ 30pF) | | | | | | | | | | | | | | | | |
| | I.R. | More than 3,000MΩ | Before this test, the test shown in the following is performed. -Item 11 Adhesive Strength of Termination (apply force is 5N) -Item 13 Deflection Apply the rated voltage at 40±2°C and relative humidity of 90 to 95% for 500±2 ⁴ hrs. Remove and let sit for 24±2 hrs. at room condition,*1 then measure. •Pretreatment for X7R char. Perform a heat treatment at 150±10 °C for 60±5 min. and then let sit for 24±2 hrs. at room condition.*1 | | | | | | | | | | | | | | |
| | Dielectric Strength | In accordance with item No.4 | | | | | | | | | | | | | | | |
| 20 | Active Flammability | | | The cheesecloth should not be on fire. | | | | | | | | | | | | | |
| | | | | The capacitor should be individually wrapped in at least one but not more than two complete layers of cheesecloth. The capacitor should be subjected to 20 discharges. The interval between successive discharges should be 5 sec. The UAC should be maintained for 2 min. after the last discharge. | | | | | | | | | | | | | |
| | | | | |  | | | | | | | | | | | | |
| | | | <table style="width: 100%; border: none;"> <tr> <td style="width: 50%;">C1,2 : 1μF±10%</td> <td style="width: 50%;">C3 : 0.033μF±5% 10kV</td> </tr> <tr> <td>L1 to 4 : 1.5mH±20% 16A Rod core choke</td> <td></td> </tr> <tr> <td>Ct : 3μF±5% 10kV</td> <td>R : 100Ω±2%</td> </tr> <tr> <td>Cx : Capacitor under test</td> <td>UAC : UR±5%</td> </tr> <tr> <td>F : Fuse, Rated 16A</td> <td>UR : Rated Voltage</td> </tr> <tr> <td></td> <td>Ut : Voltage applied to Ct</td> </tr> </table> | | | C1,2 : 1μF±10% | C3 : 0.033μF±5% 10kV | L1 to 4 : 1.5mH±20% 16A Rod core choke | | Ct : 3μF±5% 10kV | R : 100Ω±2% | Cx : Capacitor under test | UAC : UR±5% | F : Fuse, Rated 16A | UR : Rated Voltage | | Ut : Voltage applied to Ct |
| | | | | | | C1,2 : 1μF±10% | C3 : 0.033μF±5% 10kV | | | | | | | | | | |
| L1 to 4 : 1.5mH±20% 16A Rod core choke | | | | | | | | | | | | | | | | | |
| Ct : 3μF±5% 10kV | R : 100Ω±2% | | | | | | | | | | | | | | | | |
| Cx : Capacitor under test | UAC : UR±5% | | | | | | | | | | | | | | | | |
| F : Fuse, Rated 16A | UR : Rated Voltage | | | | | | | | | | | | | | | | |
| | Ut : Voltage applied to Ct | | | | | | | | | | | | | | | | |
|  <table style="margin-left: auto; margin-right: auto; border: 1px solid black; text-align: center;"> <thead> <tr> <th>Type</th> <th>Ui</th> </tr> </thead> <tbody> <tr> <td>GD, GB</td> <td>2.5kV</td> </tr> <tr> <td>GC, GF</td> <td>5kV</td> </tr> </tbody> </table> | Type | Ui | GD, GB | 2.5kV | GC, GF | 5kV | | | | | | | | | | | |
| | Type | Ui | | | | | | | | | | | | | | | |
| | GD, GB | 2.5kV | | | | | | | | | | | | | | | |
| | GC, GF | 5kV | | | | | | | | | | | | | | | |
| | 21 | Passive Flammability | | The burning time should not exceed 30 sec. The tissue paper should not ignite. | | | | | | | | | | | | | |
| The capacitor under test should be held in the flame in the position which best promotes burning. Each specimen should be exposed to the flame only once. Time of exposure to flame: 30 sec. Length of flame : 12±1mm Gas burner : Length 35mm min. Inside Dia. 0.5±0.1mm Outside Dia. 0.9mm max. Gas : Butane gas Purity 95% min. | | | | | | | | | | | | | | | | | |
| | | | |  | | | | | | | | | | | | | |
| | | | | | | | | | | | | | | | | | |
| | | | | | | | | | | | | | | | | | |
| | | | | | | | | | | | | | | | | | |

*1 "Room condition" Temperature: 15 to 35°C, Relative humidity: 45 to 75%, Atmospheric pressure: 86 to 106kPa

*2 "C" expresses nominal capacitance value (pF).

For General Purpose GRM/GRJ Series

Only for Applications

AC250V Type GA2 Series

Safety Standard Certified GA3 Series

Product Information

GRM/GRJ/GR4/GR7/GA2/GA3 Series Reference Data (Typical Example)

For General Purpose
GRM/GRJ Series

Only for Applications

AC250V Type
GA2 Series

Safety Standard
Certified GA3 Series

Product Information
Reference Data

Capacitance - Temperature Characteristics

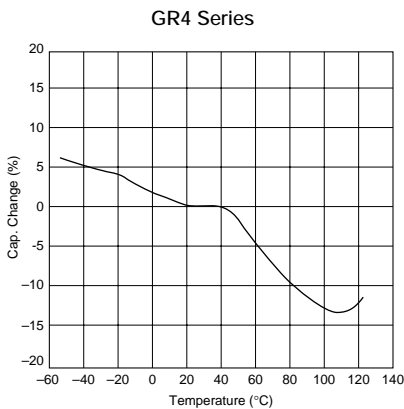
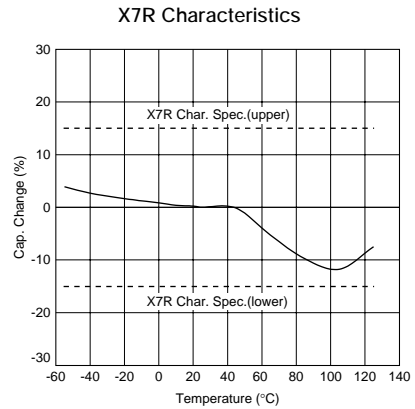
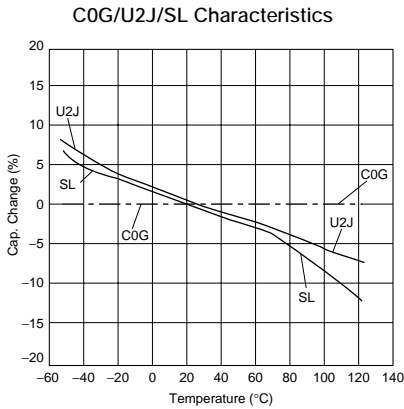

Impedance - Frequency Characteristics

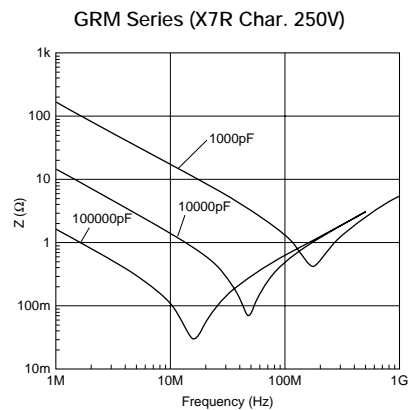
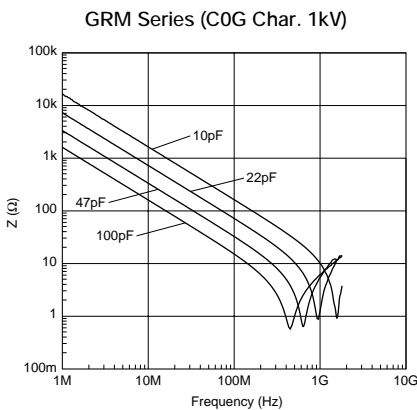
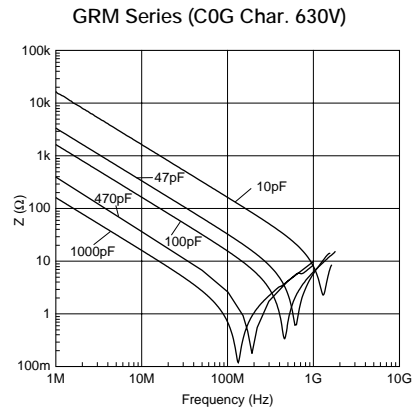
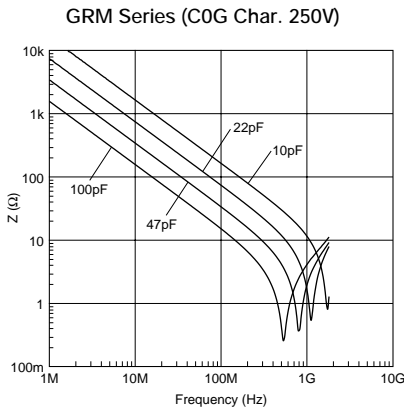

Continued on the following page. ↗

GRM/GRJ/GR4/GR7/GA2/GA3 Series Reference Data (Typical Example)

Continued from the preceding page.

Impedance - Frequency Characteristics

GRM Series (X7R Char. 630V)

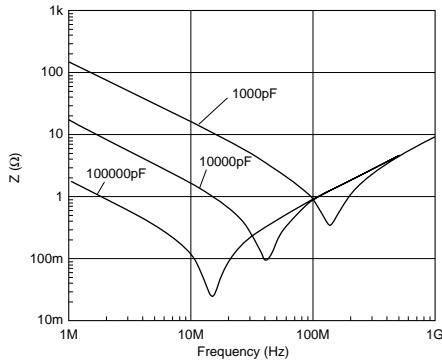

GRJ Series (X7R Char. 250V)

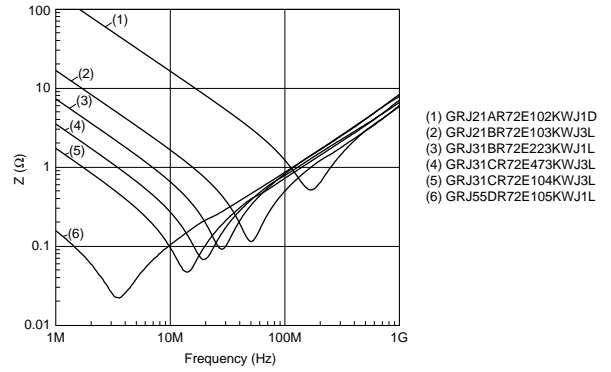

GRJ Series (X7R Char. 630V)

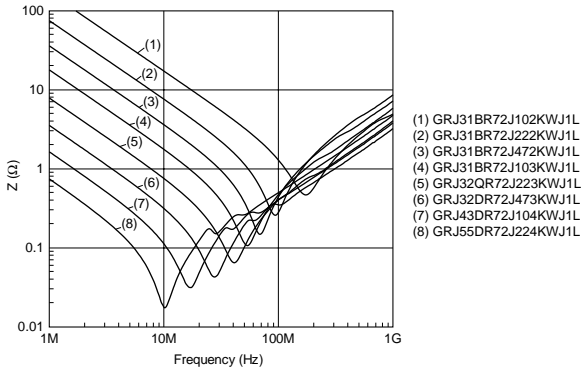

GR4 Series

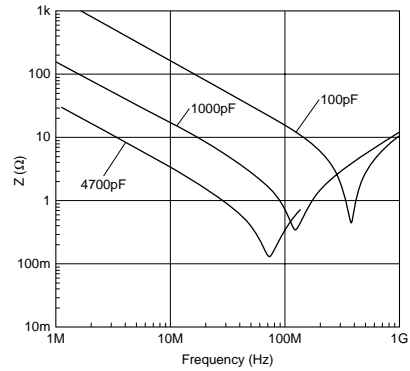

GA2 Series

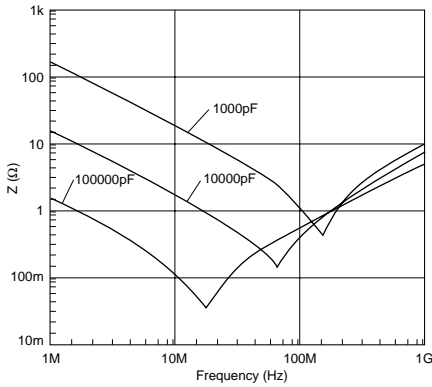

GA3 Series (Type GF)

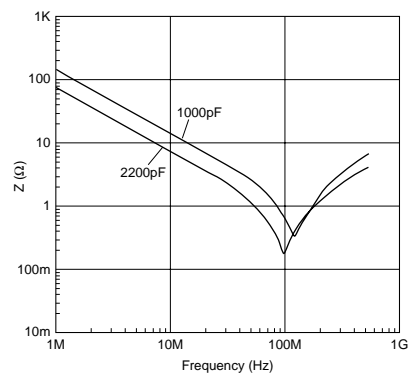

GA3 Series (Type GD)

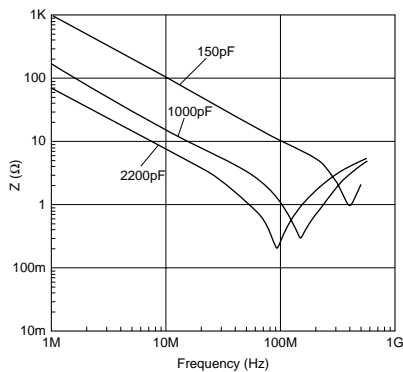

GA3 Series (Type GB)

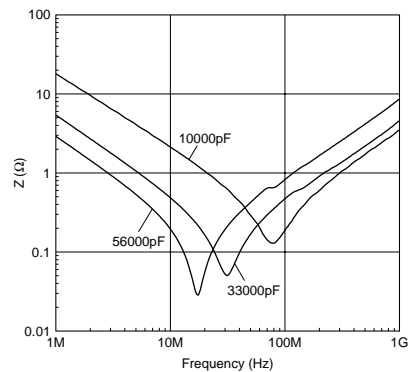

Continued on the following page.

GRM/GRJ/GR4/GR7/GA2/GA3 Series Reference Data (Typical Example)

Continued from the preceding page.

Capacitance - AC Voltage Characteristics

GA3 Series (Type GF/GD, X7R Char.)

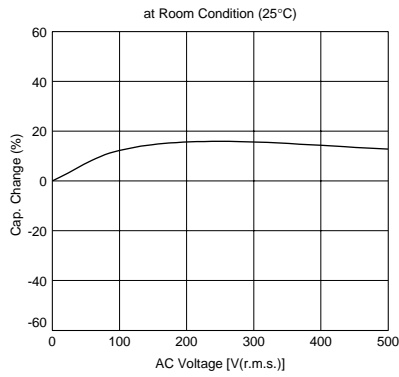

GA3 Series (Type GB)

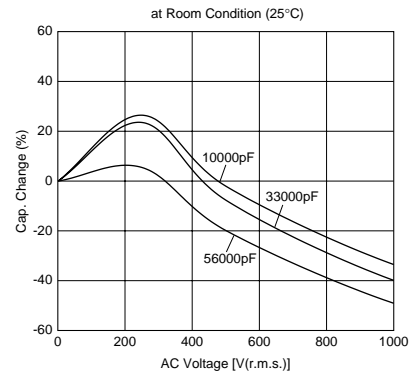

Capacitance - DC Bias Characteristics

GR7 Series

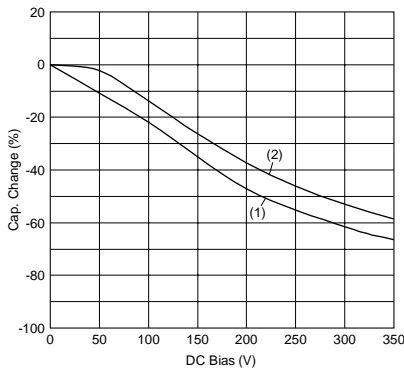

- (1) GR721AW0BB103KW01D
 GR721AW0BB153KW01D
 GR721BW0BB223KW03L
 GR731AW0BB223KW01D
 GR721BW0BB273KW03L
 GR731AW0BB273KW01D
 GR731AW0BB333KW01D

- (2) GR731AW0BB103KW01D
 GR731AW0BB153KW01D
 GR731BW0BB223KW01L
 GR731BW0BB333KW01L
 GR731CW0BB473KW03L

Package

Taping is the standard packaging method.

Minimum Quantity Guide

| Part Number | | Dimensions (mm) | | | Quantity (pcs.) | |
|---------------------------|-------------------|-----------------|------|------|-----------------|---------------|
| | | L | W | T | ø180mm Reel | |
| | | | | | Paper Tape | Embossed Tape |
| Medium Voltage | GRM18 | 1.6 | 0.8 | 0.8 | 4,000 | - |
| | GRJ21/GRM21/GR721 | 2.0 | 1.25 | 1.0 | 4,000 | - |
| | | | | 1.25 | - | 3,000 |
| | GRJ31/GRM31/GR731 | 3.2 | 1.6 | 1.0 | 4,000 | - |
| | | | | 1.25 | - | 3,000 |
| | | | | 1.6 | - | 2,000 |
| | GRJ32/GRM32 | 3.2 | 2.5 | 1.0 | 4,000 | - |
| | | | | 1.25 | - | 3,000 |
| | | | | 1.5 | - | 2,000 |
| | | | | 2.0 | - | 1,000 |
| GRM42/GR442 | 4.5 | 2.0 | 1.0 | - | 3,000 | |
| | | | 1.5 | - | 2,000 | |
| GRJ43/GRM43/GR443 | 4.5 | 3.2 | 1.5 | - | 1,000 | |
| | | | 2.0 | - | 1,000 | |
| | | | 2.5 | - | 500 | |
| GRJ55/GRM55/GR455 | 5.7 | 5.0 | 2.0 | - | 1,000 | |
| AC250V | GA242 | 4.5 | 2.0 | 1.5 | - | 2,000 |
| | GA243 | 4.5 | 3.2 | 1.5 | - | 1,000 |
| | | | | 2.0 | - | 1,000 |
| GA255 | 5.7 | 5.0 | 2.0 | - | 1,000 | |
| Safety Std. Certification | GA342 | 4.5 | 2.0 | 1.0 | - | 3,000 |
| | | | | 1.5 | - | 2,000 |
| | | | | 2.0 | - | 2,000 |
| | GA343 | 4.5 | 3.2 | 1.5 | - | 1,000 |
| | | | | 2.0 | - | 1,000 |
| | GA352 | 5.7 | 2.8 | 1.5 | - | 1,000 |
| | GA355 | 5.7 | 5.0 | 1.5 | - | 1,000 |
| | | | | 2.0 | - | 1,000 |
| 2.5 | | | | - | 500 | |
| 2.7 | | | | - | 500 | |
| | | | 2.9 | - | 500 | |

For General Purpose GRM/GRJ Series

Only for Applications

AC250V Type GA2 Series

Safety Standard Certified GA3 Series

Product Information Package

Tape Carrier Packaging

(1) Appearance of Taping

① Embossed Tape

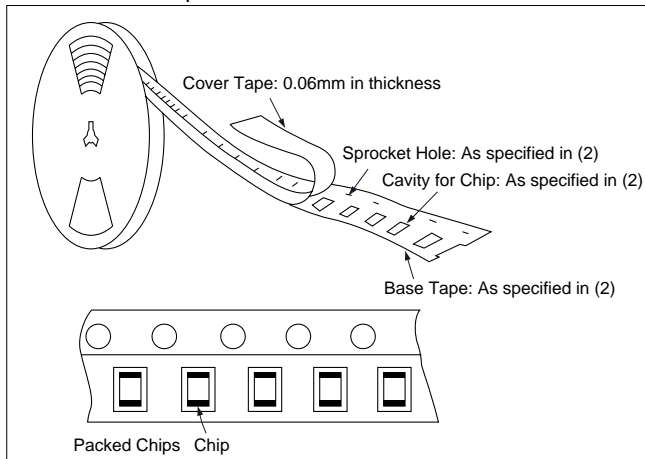

② Paper Tape

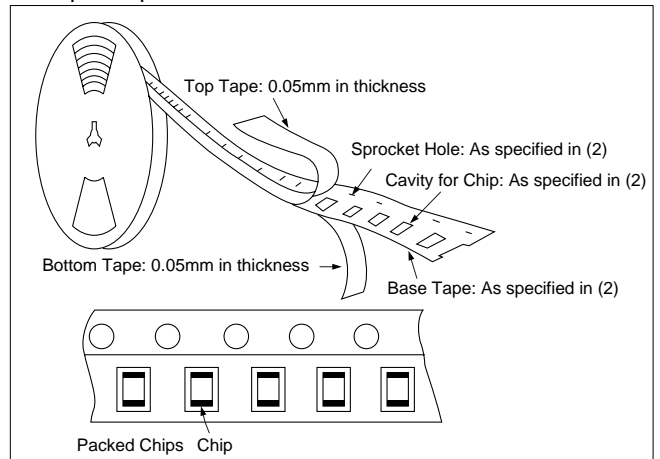

Continued on the following page. ↗

Package

☐ Continued from the preceding page.

(2) Dimensions of Tape

① Embossed Tape

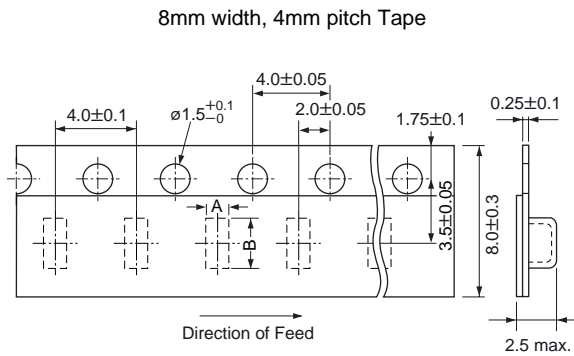

| Part Number | A* | B* |
|--|------|------|
| GRJ21/GRM21/GR721 (T≥1.25mm) | 1.45 | 2.25 |
| GRJ31/GRM31/GR731 (T≥1.25mm) | 2.0 | 3.6 |
| GRJ32/GRM32 (T≥1.25mm) | 2.9 | 3.6 |

*Nominal Value

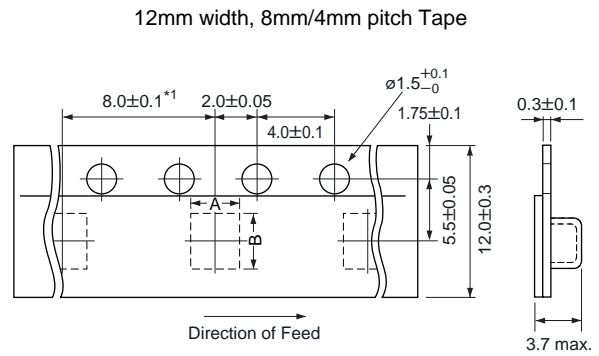

| Part Number | A* | B* |
|--------------------------------------|-----|-----|
| GRM42/GR442/GA242/GA342 | 2.5 | 5.1 |
| GRJ43/GRM43/GR443/GA243/GA343 | 3.6 | 4.9 |
| GA352 | 3.2 | 6.1 |
| GRJ55/GRM55/GR455/GA255/GA355 | 5.4 | 6.1 |

*1 4.0±0.1mm in case of GRM42/GR442/GA242/GA342

*Nominal Value

(in mm)

② Paper Tape

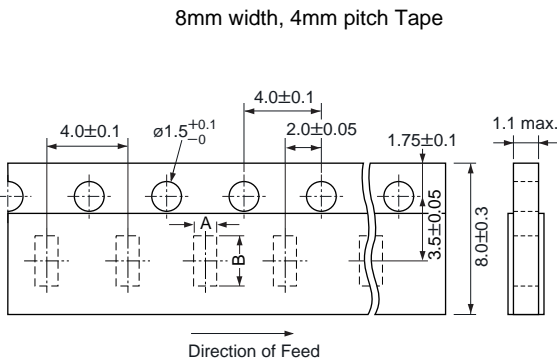

| Part Number | A* | B* |
|---------------------------------------|------|------|
| GRM18 | 1.05 | 1.85 |
| GRJ21/GRM21/GR721 (T=1.0mm) | 1.45 | 2.25 |
| GRM31/GR731 (T=1.0mm) | 2.0 | 3.6 |
| GRM32 (T=1.0mm) | 2.9 | 3.6 |

*Nominal Value
(in mm)

(3) Dimensions of Reel

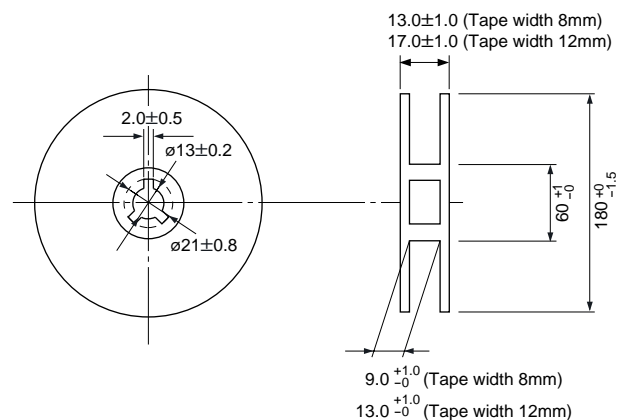

(in mm)

Continued on the following page. ☐

Package

☐ Continued from the preceding page.

(4) Taping Method

- ① Tapes for capacitors are wound clockwise. The sprocket holes are to the right as the tape is pulled toward the user.
- ② Part of the leader and part of the empty tape should be attached to the end of the tape as shown at right.
- ③ The top tape or cover tape and base tape are not attached at the end of the tape for a minimum of 5 pitches.
- ④ Missing capacitors number within 0.1% of the number per reel or 1 pc, whichever is greater, and are not continuous.
- ⑤ The top tape or cover tape and bottom tape should not protrude beyond the edges of the tape and should not cover sprocket holes.
- ⑥ Cumulative tolerance of sprocket holes, 10 pitches: $\pm 0.3\text{mm}$.
- ⑦ Peeling off force: 0.1 to 0.6N in the direction shown at right.

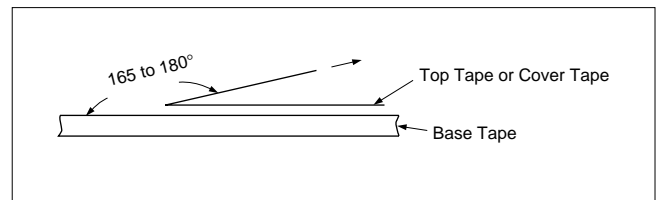
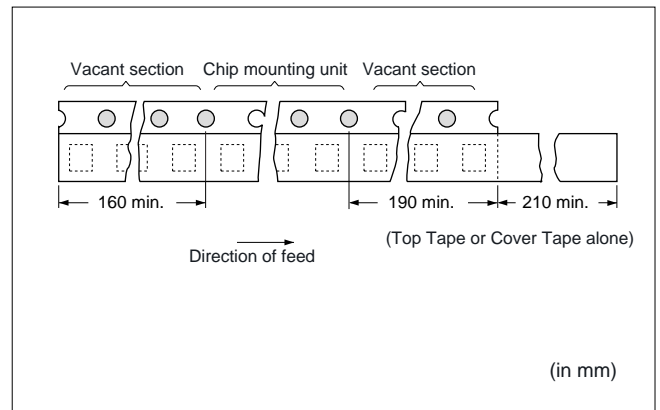

For General Purpose
 GRM/GRJ Series

Only for Applications

AC250V Type
 GA2 Series

Safety Standard
 Certified GA3 Series

Product Information
 Package

⚠ Caution

■ Storage and Operating Conditions

Operating and storage environment

Do not use or store capacitors in a corrosive atmosphere, especially where chloride gas, sulfide gas, acid, alkali, salt or the like are present. In addition, avoid exposure to moisture. Before cleaning, bonding or molding this product, verify that these processes do not affect product quality by testing the performance of a cleaned, bonded or molded product in the intended equipment. Store the capacitors where the temperature and relative humidity do not exceed 5 to 40 degrees centigrade and 20 to 70%.

Use capacitors within 6 months of delivery.
Check the solderability after 6 months or more.

FAILURE TO FOLLOW THE ABOVE CAUTIONS MAY RESULT, WORST CASE, IN A SHORT CIRCUIT AND CAUSE FUMING OR PARTIAL DISPERSION WHEN THE PRODUCT IS USED.

■ Handling

1. Vibration and impact

Do not expose a capacitor to excessive shock or vibration during use.

2. Do not directly touch the chip capacitor, especially the ceramic body. Residue from hands/fingers may create a short circuit environment.

FAILURE TO FOLLOW THE ABOVE CAUTIONS MAY RESULT, WORST CASE, IN A SHORT CIRCUIT AND CAUSE FUMING OR PARTIAL DISPERSION WHEN THE PRODUCT IS USED.

Caution

Caution (Rating)

1. Operating Voltage

When DC-rated capacitors are to be used in AC or ripple current circuits, be sure to maintain the V_{p-p} value of the applied voltage or the V_{0-p} which contains DC bias within the rated voltage range.

When the voltage is applied to the circuit, starting or stopping may generate irregular voltage for a transit period because of resonance or switching. Be sure to use a capacitor with a rated voltage range that includes these irregular voltages.

When DC-rated capacitors are to be used in input circuits from a commercial power source (AC filter), be sure to use Safety Certified Capacitors because various regulations for withstanding voltage or impulses, established for all equipment, should be taken into consideration.

| Voltage | DC Voltage | DC+AC Voltage | AC Voltage | Pulse Voltage (1) | Pulse Voltage (2) |
|------------------------|------------|---------------|------------|-------------------|-------------------|
| Positional Measurement | | | | | |

2. Operating Temperature, Self-generated Heat, and Load Reduction at High-frequency Voltage Condition
 Keep the surface temperature of a capacitor below the upper limit of its rated operating temperature range.
 Be sure to take into account the heat generated by the capacitor itself. When the capacitor is used in a high-frequency voltage, pulse voltage, it may self-generate heat due to dielectric loss.

- (1) In the case of X7R char.
 Applied voltage should be the load such as self-generated heat is within 20°C on the condition of atmosphere temperature 25°C. When measuring, use a thermocouple of small thermal capacity -K of $\phi 0.1\text{mm}$ in conditions where the capacitor is not affected by radiant heat from other components or surrounding ambient fluctuations. Excessive heat may lead to deterioration of the capacitor's characteristics and reliability. (Never attempt to perform measurement with the cooling fan running. Otherwise, accurate measurement cannot be ensured.)

Continued on the following page.

For General Purpose
GRM/GRJ Series

Only for Applications

AC250V Type
GA2 Series

Safety Standard
Certified GA3 Series

Product Information
△Caution

Caution

Continued from the preceding page.

(2) In case of C0G, U2J char.

Due to the low self-heating characteristics of low-dissipation capacitors, the allowable electric power of these capacitors is generally much higher than that of X7R characteristic capacitors.

When a high frequency voltage that causes 20°C self-heating to the capacitor is applied, it will exceed the capacitor's allowable electric power.

The frequency of the applied sine wave voltage should be less than 500kHz (less than 100kHz in the case of rated voltage: DC3.15kV). The applied voltage should be less than the value shown in figure below.

In the case of non-sine wave that includes a harmonic frequency, please contact our sales representatives or product engineers. Excessive heat may lead to deterioration of the capacitor's characteristics and reliability. (Never attempt to perform measurement with the cooling fan running. Otherwise, accurate measurement cannot be ensured.)

<C0G char., Rated Voltage: DC3.15kV>

The capacitors less than 22pF can be applied maximum 4.0kV peak to peak at 100kHz or less only for the ballast or the resonance usage in the LCD backlight inverter circuit.

<Capacitor Selection Tool>

We are also offering free software/the capacitor selection tool: "Murata Medium Voltage Capacitors Selection Tool by Voltage Form," which will assist you in selecting a suitable capacitor.

The software can be downloaded from Murata's Website. (<http://www.murata.com/designlib/mmcsv/index.html>). By inputting capacitance values and the applied voltage waveform of the specific capacitor series, this software will calculate the capacitor's power consumption and list suitable capacitors (non-sine wave is also available).

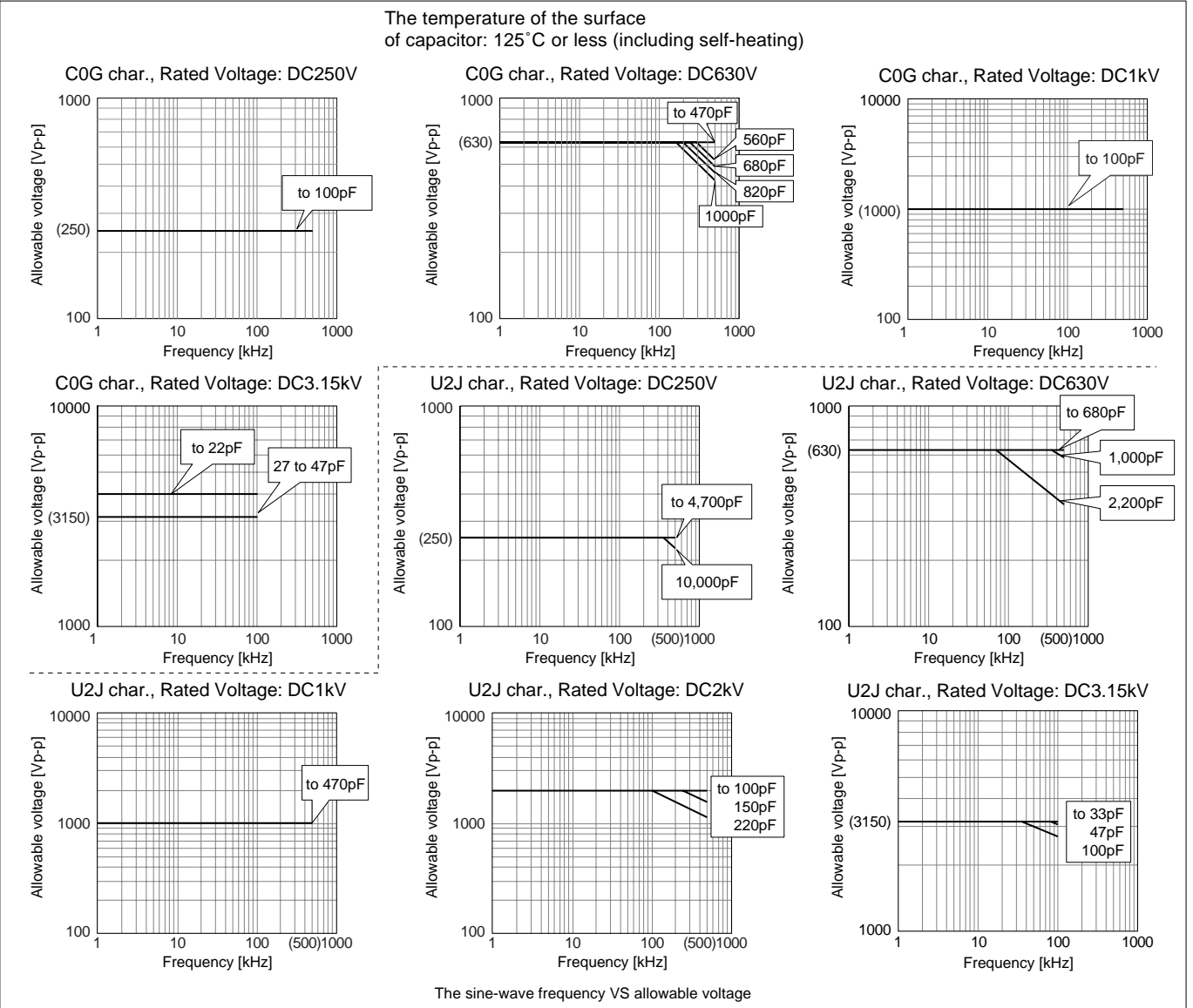

Continued on the following page.

⚠Caution

☐ Continued from the preceding page.

3. Fail-safe

Failure of a capacitor may result in a short circuit. Be sure to provide an appropriate fail-safe function such as a fuse on your product to help eliminate possible electric shock, fire, or fumes.

Please consider using fuses on each AC line if the capacitors are used between the AC input lines and earth (line bypass capacitors), to prepare for the worst case, such as a short circuit.

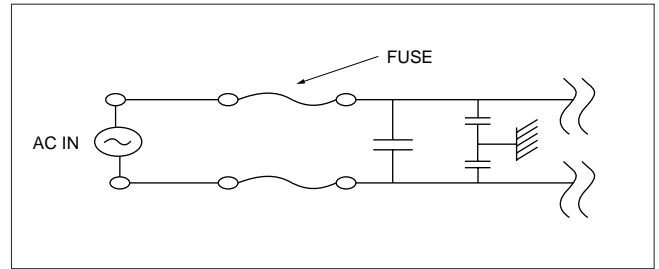

4. Test Condition for AC Withstanding Voltage

(1) Test Equipment

Tests for AC withstanding voltage should be made with equipment capable of creating a wave similar to a 50/60 Hz sine wave.

If the distorted sine wave or overload exceeding the specified voltage value is applied, a defect may be caused.

(2) Voltage Applied Method

The capacitor's leads or terminals should be firmly connected to the output of the withstanding voltage test equipment, and then the voltage should be raised from near zero to the test voltage. If the test voltage is applied directly to the capacitor without raising it from near zero, it should be applied with the zero cross.* At the end of the test time, the test voltage should be reduced to near zero, and then the capacitor's leads or terminals should be taken off the output of the withstanding voltage test equipment. If the test voltage is applied directly to the capacitor without raising it from near zero, surge voltage may occur and cause a defect.

*ZERO CROSS is the point where voltage sine wave passes 0V.

- See the figure at right -

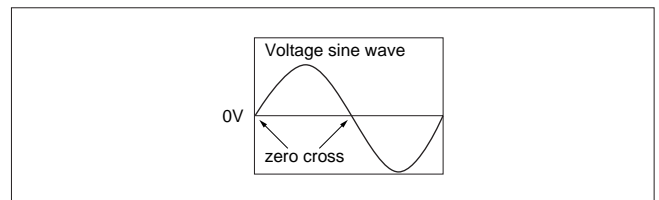

FAILURE TO FOLLOW THE ABOVE CAUTIONS MAY RESULT, WORST CASE, IN A SHORT CIRCUIT AND CAUSE FUMING OR PARTIAL DISPERSION WHEN THE PRODUCT IS USED.

For General Purpose
GRM/GRJ Series

Only for Applications

AC250V Type
GA2 Series

Safety Standard
Certified GA3 Series

Product Information
⚠Caution

△Caution

■ **Caution (Soldering and Mounting)**

1. **Vibration and Impact**

Do not expose a capacitor to excessive shock or vibration during use.

2. **Circuit Board Material**

It is possible for the chip to crack by the expansion and shrinkage of a metal board.
 Please contact us if you want to use our ceramic capacitors on a metal board such as Aluminum.

3. **Land Layout for Cropping PC Board**

Choose a mounting position that minimizes the stress imposed on the chip during flexing or bending of the board.

[Component Direction]

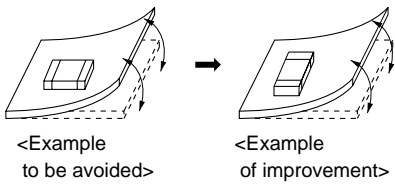

Locate chip horizontal to the direction in which stress acts.

[Chip Mounting Close to Board Separation Point]

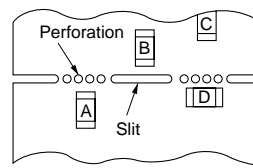

Chip arrangement
 Worst A>C>B~D Best

Continued on the following page.



Continued from the preceding page.

4. Reflow Soldering

- When components are exposed to sudden heat, their mechanical strength can be decreased due to the extreme temperature changes which can cause flexing and result in internal mechanical damage, which will cause the parts to fail. In order to prevent mechanical damage, preheating is required for both the components and the PCB board. Preheating conditions are shown in Table 1. It is required to keep the temperature differential between the soldering and the components surface (ΔT) as small as possible.
- Solderability of Tin plating termination chips might be deteriorated when low temperature soldering profile where peak solder temperature is below the Tin melting point is used. Please confirm the solderability of Tin plating termination chips before use.
- When components are immersed in solvent after mounting, be sure to maintain the temperature difference (ΔT) between the component and solvent within the range shown in the Table 1.

Table 1

| Part Number | Temperature Differential |
|-------------------|-----------------------------------|
| G□□18/21/31 | $\Delta T \leq 190^\circ\text{C}$ |
| G□□32/42/43/52/55 | $\Delta T \leq 130^\circ\text{C}$ |

Recommended Conditions

| | Pb-Sn Solder | | Lead Free Solder |
|------------------|-----------------|--------------|-----------------------|
| | Infrared Reflow | Vapor Reflow | |
| Peak Temperature | 230-250°C | 230-240°C | 240-260°C |
| Atmosphere | Air | Air | Air or N ₂ |

Pb-Sn Solder: Sn-37Pb
 Lead Free Solder: Sn-3.0Ag-0.5Cu

Optimum Solder Amount for Reflow Soldering

- Overly thick application of solder paste results in excessive solder fillet height. This makes the chip more susceptible to mechanical and thermal stress on the board and may cause cracked chips.
- Too little solder paste results in a lack of adhesive strength on the outer electrode, which may result in chips breaking loose from the PCB.
- Make sure the solder has been applied smoothly to the end surface to a height of 0.2mm min.

Inverting the PCB

Make sure not to impose an abnormal mechanical shock on the PCB.

[Standard Conditions for Reflow Soldering]

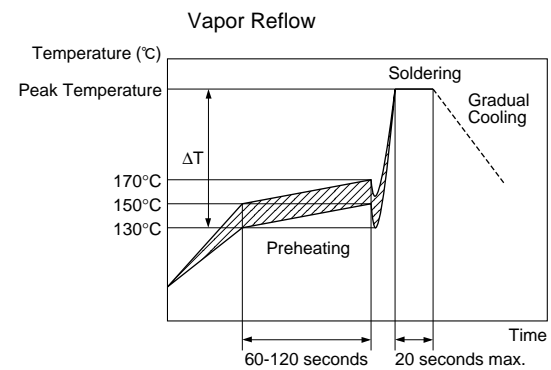
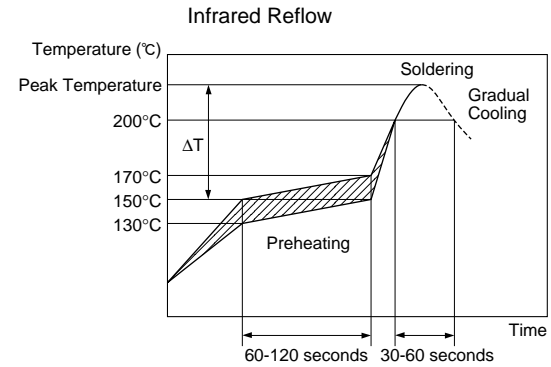

[Allowable Soldering Temperature and Time]

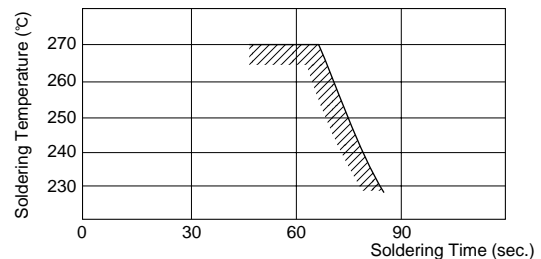

In the case of repeated soldering, the accumulated soldering time must be within the range shown above.

[Optimum Solder Amount for Reflow Soldering]

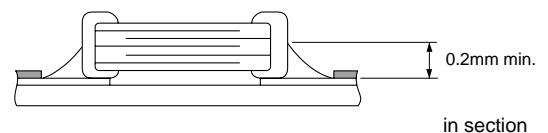

For General Purpose GRM/GRJ Series

Only for Applications

AC250V Type GA2 Series

Safety Standard Certified GA3 Series

Product Information **Caution**

Caution

Continued from the preceding page.

5. Flow Soldering

- When components are exposed to sudden heat, their mechanical strength can be decreased due to the extreme temperature changes which can cause flexing and result in internal mechanical damage, which will cause the parts to fail. Additionally, an excessively long soldering time or high soldering temperature results in leaching by the outer electrodes, causing poor adhesion or a reduction in capacitance value due to loss of contact between electrodes and end termination.
- In order to prevent mechanical damage, preheating is required for both the components and the PCB board. Preheating conditions are shown in Table 2. It is required to keep temperature differential between the soldering and the components surface (ΔT) as small as possible.
- When components are immersed in solvent after mounting, be sure to maintain the temperature difference between the component and solvent within the range shown in Table 2.
Do not apply flow soldering to chips not listed in Table 2.

Table 2

| Part Number | Temperature Differential |
|-------------|-----------------------------------|
| G□□18/21/31 | $\Delta T \leq 150^\circ\text{C}$ |

Recommended Conditions

| | Pb-Sn Solder | Lead Free Solder |
|------------------|--------------|------------------|
| Peak Temperature | 240-250°C | 250-260°C |
| Atmosphere | Air | N ₂ |

Pb-Sn Solder: Sn-37Pb
 Lead Free Solder: Sn-3.0Ag-0.5Cu

- Optimum Solder Amount for Flow Soldering**
 The top of the solder fillet should be lower than the thickness of components. If the solder amount is excessively large, the risk of cracking is higher during board bending or under any other stressful conditions.

[Standard Conditions for Flow Soldering]

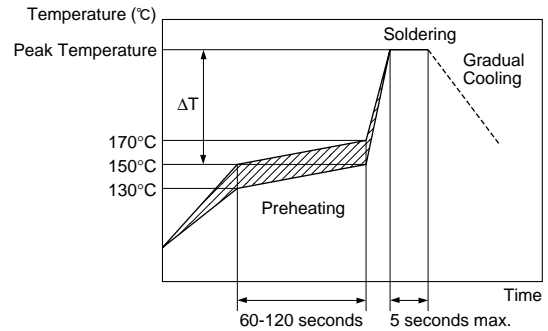

[Allowable Soldering Temperature and Time]

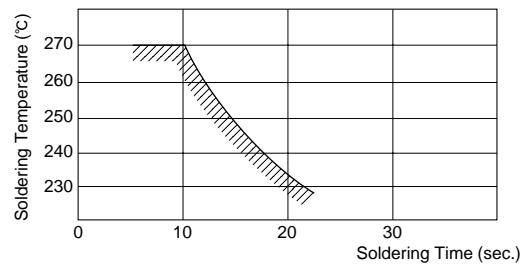

In the case of repeated soldering, the accumulated soldering time must be within the range shown above.

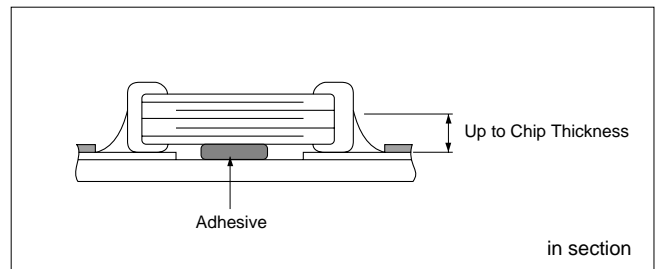

Continued on the following page. ↗

Caution

Continued from the preceding page.

6. Correction with a Soldering Iron

- When sudden heat is applied to the components by use of a soldering iron, the mechanical strength of the components will decrease because the extreme temperature change causes deformations inside the components.

In order to prevent mechanical damage to the components, preheating is required for both the components and the PCB board.

Preheating conditions, (The "Temperature of the Soldering Iron Tip", "Preheating Temperature," "Temperature Differential" between iron tip and the

components and the PCB), should be within the conditions of table 3.

It is required to keep the temperature differential between the soldering Iron and the component's surface (ΔT) as small as possible.

After soldering, do not allow the component/PCB to cool down rapidly.

The operating time for the re-working should be as short as possible. When re-working time is too long, it may cause solder leaching, in turn causing a reduction of the adhesive strength of the terminations.

Table 3

| Part Number | Temperature of Soldering Iron tip | Preheating Temperature | Temperature Differential (ΔT) | Atmosphere |
|-------------------|-----------------------------------|------------------------|---|------------|
| G□□18/21/31 | 350°C max. | 150°C min. | $\Delta T \leq 190^\circ\text{C}$ | air |
| G□□32/42/43/52/55 | 280°C max. | 150°C min. | $\Delta T \leq 130^\circ\text{C}$ | air |

*Applicable for both Pb-Sn and Lead Free Solder.

Pb-Sn Solder: Sn-37Pb

Lead Free Solder: Sn-3.0Ag-0.5Cu

- Optimum Solder Amount when re-working Using a Soldering Iron

For sizes smaller than G□□18, the top of the solder fillet should be lower than 2/3 of the thickness of the component or 0.5mm whichever is smaller.

For sizes larger than G□□21, the top of the solder fillet should be lower than 2/3 of the thickness of the component.

If the solder amount is excessive, the risk of cracking is higher during board bending or under any other stressful conditions.

A Soldering iron $\phi 3\text{mm}$ or smaller should be used.

It is also necessary to keep the soldering iron from touching the components during the re-work.

Solder wire with $\phi 0.5\text{mm}$ or smaller is required for soldering.

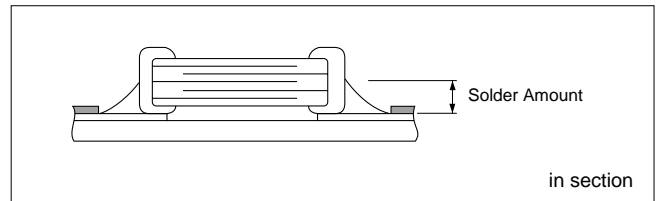

7. Washing

Excessive output of ultrasonic oscillation during cleaning causes PCBs to resonate, resulting in cracked chips or broken solder. Take note not to vibrate PCBs.

FAILURE TO FOLLOW THE ABOVE CAUTIONS MAY RESULT, WORST CASE, IN A SHORT CIRCUIT AND FUMING WHEN THE PRODUCT IS USED.

For General Purpose GRM/GRJ Series

Only for Applications

AC250V Type GA2 Series

Safety Standard Certified GA3 Series

Product Information △Caution

Notice

■ Notice (Soldering and Mounting)

1. Construction of Board Pattern

After installing chips, if solder is excessively applied to the circuit board, mechanical stress will cause destruction resistance characteristics to lower. To prevent this, be extremely careful in determining shape and dimension before designing the circuit board diagram.

Construction and Dimensions of Pattern (Example)

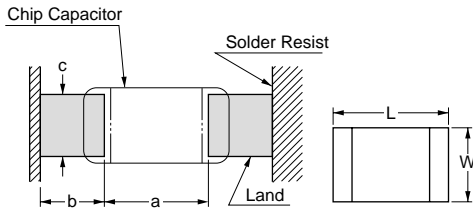

Flow Soldering

| L×W | a | b | c |
|----------|---------|---------|---------|
| 1.6×0.8 | 0.6-1.0 | 0.8-0.9 | 0.6-0.8 |
| 2.0×1.25 | 1.0-1.2 | 0.9-1.0 | 0.8-1.1 |
| 3.2×1.6 | 2.2-2.6 | 1.0-1.1 | 1.0-1.4 |

Flow soldering : 3.2×1.6 or less available.

Reflow Soldering

| L×W | a | b | c |
|----------|---------|---------|---------|
| 1.6×0.8 | 0.6-0.8 | 0.6-0.7 | 0.6-0.8 |
| 2.0×1.25 | 1.0-1.2 | 0.6-0.7 | 0.8-1.1 |
| 3.2×1.6 | 2.2-2.4 | 0.8-0.9 | 1.0-1.4 |
| 3.2×2.5 | 2.0-2.4 | 1.0-1.2 | 1.8-2.3 |
| 4.5×2.0 | 2.8-3.4 | 1.2-1.4 | 1.4-1.8 |
| 4.5×3.2 | 2.8-3.4 | 1.2-1.4 | 2.3-3.0 |
| 5.7×2.8 | 4.0-4.6 | 1.4-1.6 | 2.1-2.6 |
| 5.7×5.0 | 4.0-4.6 | 1.4-1.6 | 3.5-4.8 |

(in mm)

Dimensions of Slit (Example)

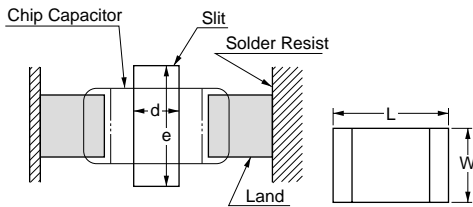

| L×W | d | e |
|----------|---------|---------|
| 1.6×0.8 | - | - |
| 2.0×1.25 | - | - |
| 3.2×1.6 | 1.0-2.0 | 3.2-3.7 |
| 3.2×2.5 | 1.0-2.0 | 4.1-4.6 |
| 4.5×2.0 | 1.0-2.8 | 3.6-4.1 |
| 4.5×3.2 | 1.0-2.8 | 4.8-5.3 |
| 5.7×2.8 | 1.0-4.0 | 4.4-4.9 |
| 5.7×5.0 | 1.0-4.0 | 6.6-7.1 |

(in mm)

Preparing the slit helps flux cleaning and resin coating on the back of the capacitor.

However, the length of the slit design should be as short as possible to prevent mechanical damage in the capacitor.

A longer slit design might receive more severe mechanical stress from the PCB.

Recommended slit design is shown in the Table.

Continued on the following page.

Notice

Continued from the preceding page.

Land Layout to Prevent Excessive Solder

| | Mounting Close to a Chassis | Mounting with Leaded Components | Mounting Leaded Components Later |
|---|-----------------------------|---------------------------------|----------------------------------|
| Examples to Be Avoided | | | |
| Examples of Improvements by the Land Division | | | |

2. Mounting of Chips

- Thickness of adhesives applied
 Keep thickness of adhesives applied (50-105µm or more) to reinforce the adhesive contact considering the thickness of the termination or capacitor (20-70µm) and the land pattern (30-35µm).
- Mechanical shock of the chip placer
 When the positioning claws and pick-up nozzle are worn, the load is applied to the chip while positioning is concentrated in one position, thus causing cracks, breakage, faulty positioning accuracy, etc.
 Careful checking and maintenance are necessary to prevent unexpected trouble.
 An excessively low bottom dead point of the suction nozzle imposes great force on the chip during mounting, causing cracked chips. Please set the suction nozzle's bottom dead point on the upper surface of the board.

3. Soldering

(1) Limit of losing effective area of the terminations and conditions needed for soldering.

Depending on the conditions of the soldering temperature and/or immersion (melting time), effective areas may be lost in some parts of the terminations.

To prevent this, be careful in soldering so that any possible loss of the effective area on the terminations will securely remain at a maximum of 25% on all edge length A-B-C-D-A of part with A, B, C, D, shown in the Figure below.

(2) Flux Application

- An excessive amount of flux generates a large quantity of flux gas, causing deteriorated solderability. So apply flux thinly and evenly throughout. (A foaming system is generally used for flow soldering.)
- Flux containing too high a percentage of halide may cause corrosion of the outer electrodes without sufficient cleaning. Use flux with a halide content of 0.2% max.
- Do not use strong acidic flux.
- Do not use water-soluble flux.*
 (*Water-soluble flux can be defined as non rosin type flux including wash-type flux and non-wash-type flux.)

(3) Solder

The use of Sn-Zn based solder will deteriorate the reliability of the MLCC.
 Please contact our sales representative or product engineers on the use of Sn-Zn based solder in advance.

Continued on the following page. ↗

For General Purpose GRM/GRJ Series

Only for Applications

AC250V Type GA2 Series

Safety Standard Certified GA3 Series

Product Information Notice

Notice

☐ Continued from the preceding page.

4. Cleaning

Please confirm there is no problem in the reliability of the product beforehand when cleaning it with the intended equipment.

The residue after cleaning it might cause a decrease in the surface resistance of the chip and the corrosion of the electrode part, etc. As a result it might cause reliability to deteriorate. Please confirm beforehand that there is no problem with the intended equipment in ultrasonic cleansing.

5. Resin Coating

Please use it after confirming there is no influence on the product with the intended equipment before the resin coating and molding.

A cracked chip might be caused at the cooling/heating cycle by the amount of resin spreading and/or bias thickness.

The resin for coating and molding must be selected as the stress is small when stiffening and the hygroscopic is low as possible.

■ Rating

1. Capacitance change of capacitor

(1) In the case of X7R char.

Capacitors have an aging characteristic, whereby the capacitor continually decreases its capacitance slightly if the capacitor is left on for a long time. Moreover, capacitance might change greatly depending on the surrounding temperature or an applied voltage. Therefore, it is not likely to be suitable for use in a time constant circuit.

Please contact us if you need detailed information.

(2) In the case of any char. except X7R

Capacitance might change a little depending on the surrounding temperature or an applied voltage.

Please contact us if you intend to use this product in a strict time constant circuit.

2. Performance check by equipment

Before using a capacitor, check that there is no problem in the equipment's performance and the specifications.

Generally speaking, CLASS 2 (X7R char.) ceramic capacitors have voltage dependence characteristics and temperature dependence characteristics in capacitance. Therefore, the capacitance value may change depending on the operating condition in the equipment.

Accordingly, be sure to confirm the apparatus performance of receiving influence in a capacitance value change of a capacitor, such as leakage current and noise suppression characteristics.

Moreover, check the surge-proof ability of a capacitor in the equipment, if needed, because the surge voltage may exceed the specific value by the inductance of the circuit.

ISO 9001 Certifications

■ Qualified Standards

The products listed here have been produced by ISO 9001 certified factory.

| Plant |
|--|
| Fukui Murata Mfg. Co., Ltd. |
| Izumo Murata Mfg. Co., Ltd. |
| Okayama Murata Mfg. Co., Ltd. |
| Murata Electronics Singapore (Pte.) Ltd. |
| Beijing Murata Electronics Co., Ltd. |
| Wuxi Murata Electronics Co., Ltd. |

Design assistant tool SimSurfing SimSurfing



MLCC is now available !

Design assistant tool "SimSurfing" has been updated and you can now find and view any kind of characteristics of MLCCs.

Available function for MLCCs.

- ① Products search
- ② View frequency characteristics (S parameters, Z, R, X, Q, DF, L, C)
- ③ DC voltage bias characteristics (Absolute capacitance/change rate)
- ④ Temperature characteristics (Absolute capacitance/change rate)
- ⑤ AC voltage bias characteristics (Absolute capacitance/change rate)
- ⑥ Download SPICE netlist/ S parameter

① Select the Products

- (1) By part number
- (2) By performance

② View characteristics

Clicking buttons in this area with partnumber selected, you can view any electrical characteristics chart.

③ Data download

You can download SPICE netlist and S parameter files (S2P)

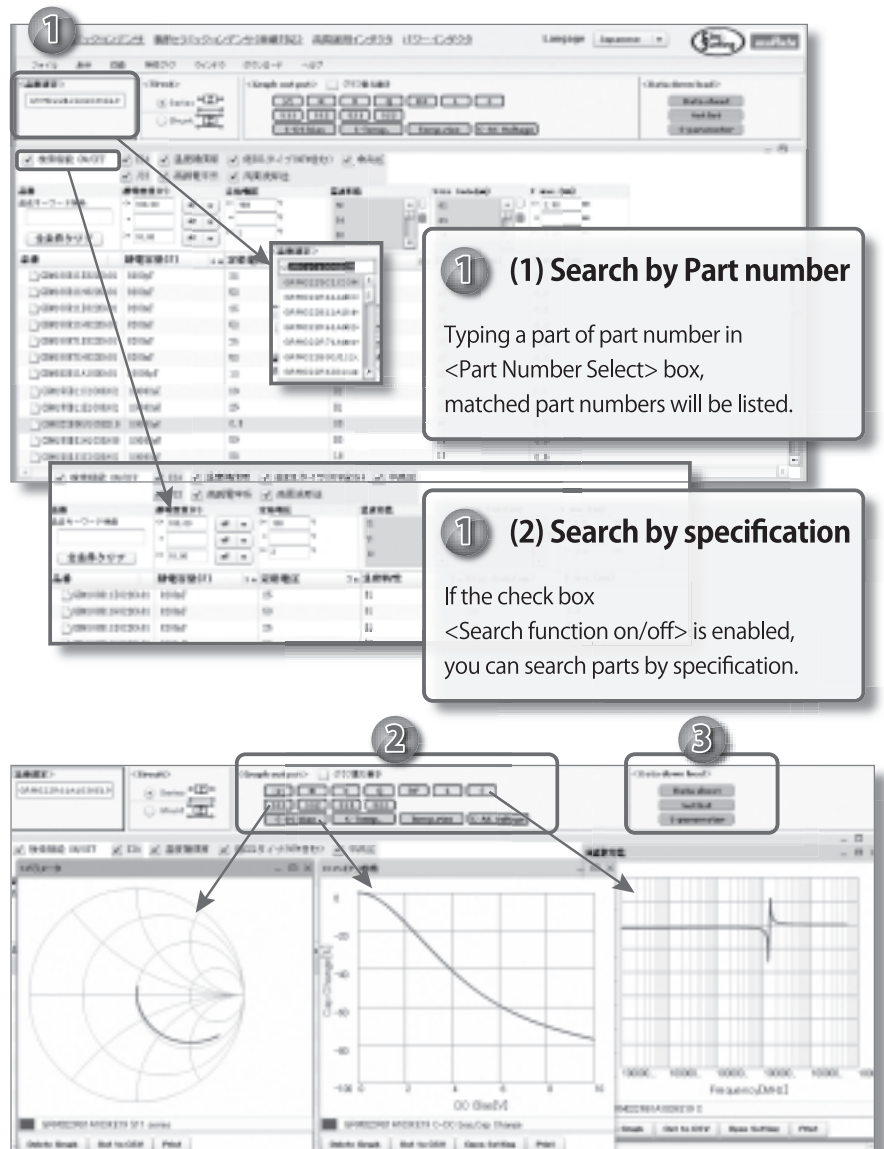

These images are captured at August/2010. Be sure that this software will be updated frequently.

<http://ds.murata.com/software/simsurfing/en-us/mlcc/>

EMICON-FUN!

Please check Murata's newsletter!
 You can learn about electric parts with fun.
http://www.murata.com/products/emicon_fun/

EMICON COLUMN introduce hand-made columns with know-how of capacitors, inductors and EMI suppression filters.
 m's CAFÉ is a relaxing easy essay. Please make yourself at home with EMICON-FUN!

You can register from Murata Manufacturing Web site page TOP.
<http://www.murata.com/>



← This banner is the entrance of register form

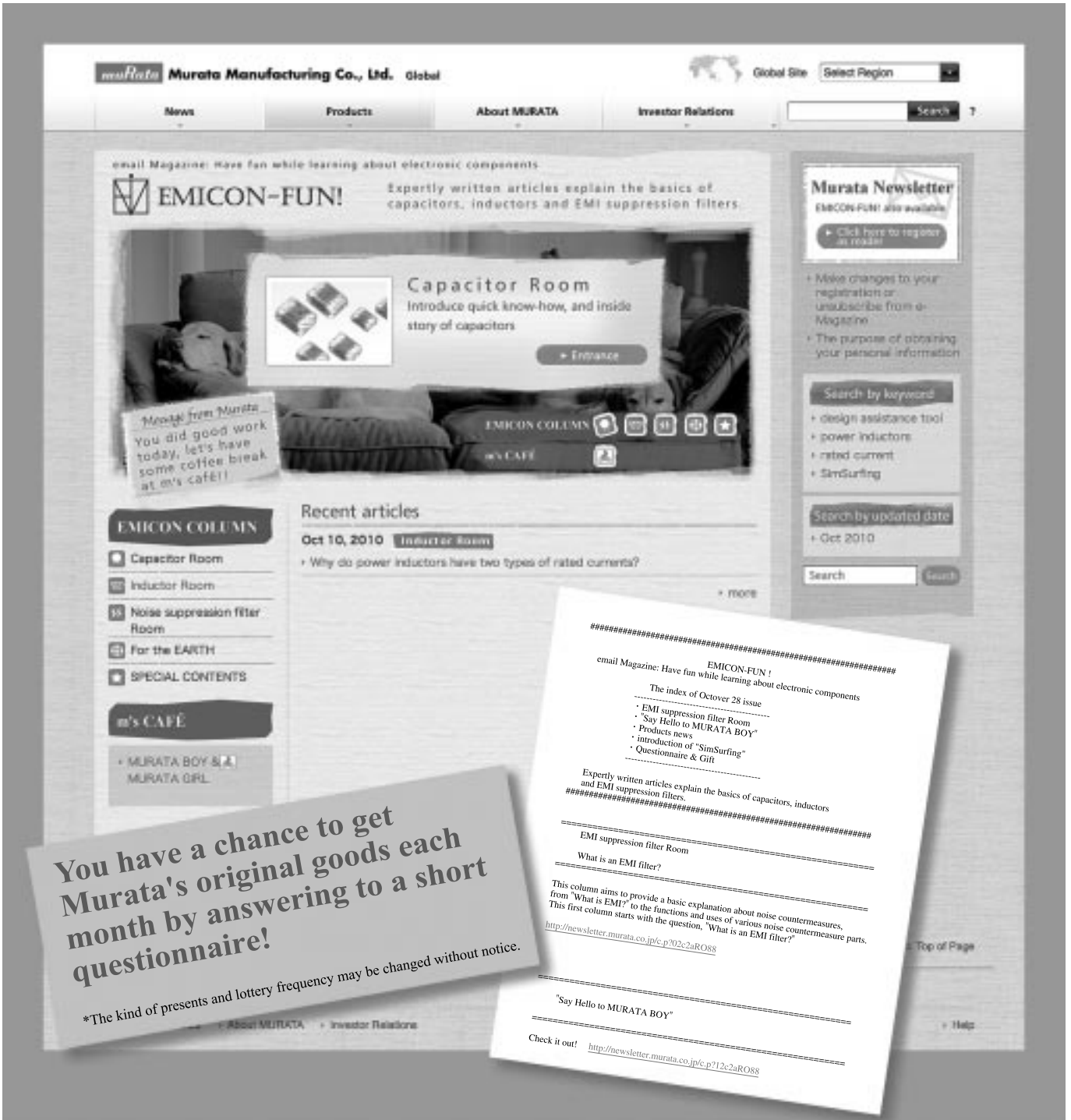

EMICON-FUN!
 Expertly written articles explain the basics of capacitors, inductors and EMI suppression filters.

Capacitor Room
 Introduce quick know-how, and inside story of capacitors

EMICON COLUMN

- Capacitor Room
- Inductor Room
- Noise suppression filter Room
- For the EARTH
- SPECIAL CONTENTS

m's CAFÉ

- MURATA BOY & MURATA GIRL

Recent articles

Oct 10, 2010 **Inductor Room**
 Why do power inductors have two types of rated currents?

Murata Newsletter
 EMICON-FUN! also available
 Click here to register at TOP!

Make changes to your registration or unsubscribe from e-Magazine!
 The purpose of obtaining your personal information

Search by keyword

- design assistance tool
- power inductors
- rated current
- SimSurfing

Search by updated date

- Oct 2010

Search

You have a chance to get Murata's original goods each month by answering to a short questionnaire!

*The kind of presents and lottery frequency may be changed without notice.

 email Magazine: Have fun while learning about electronic components
 EMICON-FUN !
 The index of October 28 issue

- EMI suppression filter Room
- "Say Hello to MURATA BOY"
- Products news
- introduction of "SimSurfing"
- Questionnaire & Gift

Expertly written articles explain the basics of capacitors, inductors and EMI suppression filters.
 #####

EMI suppression filter Room

What is an EMI filter?

This column aims to provide a basic explanation about noise countermeasures, from "What is EMI?" to the functions and uses of various noise countermeasure parts. This first column starts with the question, "What is an EMI filter?"
<http://newsletter.murata.co.jp/c.p?02c2aR088>

"Say Hello to MURATA BOY"

Check it out! <http://newsletter.murata.co.jp/c.p?12c2aR088>

△Note:

1. Export Control

<For customers outside Japan>

No Murata products should be used or sold, through any channels, for use in the design, development, production, utilization, maintenance or operation of, or otherwise contribution to (1) any weapons (Weapons of Mass Destruction [nuclear, chemical or biological weapons or missiles] or conventional weapons) or (2) goods or systems specially designed or intended for military end-use or utilization by military end-users.

<For customers in Japan>

For products which are controlled items subject to the "Foreign Exchange and Foreign Trade Law" of Japan, the export license specified by the law is required for export.

2. Please contact our sales representatives or product engineers before using the products in this catalog for the applications listed below, which require especially high reliability for the prevention of defects which might directly damage a third party's life, body or property, or when one of our products is intended for use in applications other than those specified in this catalog.

- | | |
|-----------------------------|--|
| ① Aircraft equipment | ② Aerospace equipment |
| ③ Undersea equipment | ④ Power plant equipment |
| ⑤ Medical equipment | ⑥ Transportation equipment (vehicles, trains, ships, etc.) |
| ⑦ Traffic signal equipment | ⑧ Disaster prevention / crime prevention equipment |
| ⑨ Data-processing equipment | ⑩ Application of similar complexity and/or reliability requirements to the applications listed above |

3. Product specifications in this catalog are as of September 2010. They are subject to change or our products in it may be discontinued without advance notice. Please check with our sales representatives or product engineers before ordering. If there are any questions, please contact our sales representatives or product engineers.

4. Please read rating and △CAUTION (for storage, operating, rating, soldering, mounting and handling) in this catalog to prevent smoking and/or burning, etc.

5. This catalog has only typical specifications because there is no space for detailed specifications. Therefore, please approve our product specifications or transact the approval sheet for product specifications before ordering.

6. Please note that unless otherwise specified, we shall assume no responsibility whatsoever for any conflict or dispute that may occur in connection with the effect of our and/or a third party's intellectual property rights and other related rights in consideration of your use of our products and/or information described or contained in our catalogs. In this connection, no representation shall be made to the effect that any third parties are authorized to use the rights mentioned above under licenses without our consent.

7. No ozone depleting substances (ODS) under the Montreal Protocol are used in our manufacturing process.



<http://www.murata.com/>

Head Office
1-10-1, Higashi Kotari, Nagaokakyo-shi, Kyoto 617-8555, Japan
Phone: 81-75-951-9111

International Division
3-29-12, Shibuya, Shibuya-ku, Tokyo 150-0002, Japan
Phone: 81-3-5469-6123 Fax: 81-3-5469-6155 E-mail: intl@murata.co.jp