

阅读申明

- 1.本站收集的数据手册和产品资料都来自互联网，版权归原作者所有。如读者和版权方有任何异议请及时告之，我们将妥善解决。
- 2.本站提供的中文数据手册是英文数据手册的中文翻译，其目的是协助用户阅读，该译文无法自动跟随原稿更新，同时也可能存在翻译上的不当。建议读者以英文原稿为参考以便获得更精准的信息。
- 3.本站提供的产品资料，来自厂商的技术支持或者使用者的心得体会等，其内容可能存在描述上的差异，建议读者做出适当判断。
- 4.如需与我们联系，请发邮件到marketing@iczoom.com，主题请标有“数据手册”字样。

Read Statement

1. The datasheets and other product information on the site are all from network reference or other public materials, and the copyright belongs to the original author and original published source. If readers and copyright owners have any objections, please contact us and we will deal with it in a timely manner.
2. The Chinese datasheets provided on the website is a Chinese translation of the English datasheets. Its purpose is for reader's learning exchange only and do not involve commercial purposes. The translation cannot be automatically updated with the original manuscript, and there may also be improper translations. Readers are advised to use the English manuscript as a reference for more accurate information.
3. All product information provided on the website refer to solutions from manufacturers' technical support or users the contents may have differences in description, and readers are advised to take the original article as the standard.
4. If you have any questions, please contact us at marketing@iczoom.com and mark the subject with "Datasheets" .

Film Chip Capacitor

Type: **ECWU(C)**

Stacked metallized PEN film as dielectric with simple mold - less construction



■ Features

- ◆ Small in size
- ◆ Applicable for reflow soldering

■ Recommended Applications

- ◆ Coupling
- ◆ By - pass
- ◆ General purpose

■ Explanation of Part Numbers

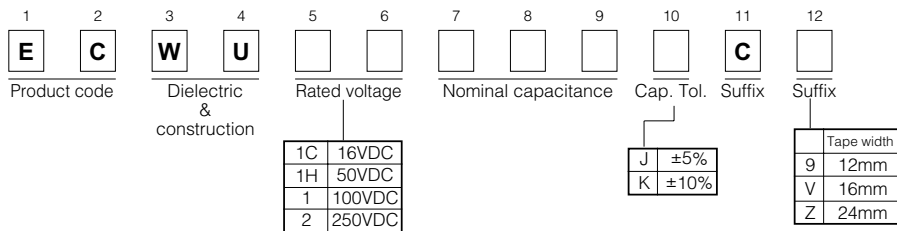

■ Specifications

Category temp.range	16VDC, 50VDC: - 55 to + 105°C	
	100VDC, 250VDC: - 40 to + 85°C	
Rated voltage	16VDC, 50VDC, 100VDC, 250VDC	
Capacitance range	16VDC	0.12 to 0.47 μF (E12)
	50VDC	0.056 to 0.22 μF (E12)
	100VDC	0.012 to 1.0 μF (E12)
	250VDC	0.001 to 1.0 μF (E12)
Capacitance tolerance	16VDC,50VDC	± 5%(J)
	100VDC,250VDC	± 10%(K) (100VDC, C≦0.15 μF ± 5%(J), ± 10%(K))
Withstand voltage	Between terminals 16VDC, 50VDC:Rated volt. (VDC)×175% 1 to 5s 100VDC, 250VDC:Rated volt. (VDC)×150% 60s	
Dissipation factor	≤ 1.0%(20°C,1kHz)	
Insulation resistance	C ≤ 0.33 μF	16VDC:≥ 3000MΩ • (20°C, 10VDC, 60s) 50VDC:≥ 3000MΩ • (20°C, 50VDC, 60s) 100VDC, 250VDC:≥ 3000MΩ • (20°C, 100VDC, 60s)
	C > 0.33 μF	16VDC:1000MΩ • μF min. (20°C, 10VDC, 60s) 100VDC, 250VDC:1000MΩ • μF min. (20°C, 100VDC, 60s)
Soldering conditions	Reflow soldering 16VDC, 50VDC:240°C max. and 30 sec max. at more than 210°C (Temp. at cap. surface) 100VDC, 250VDC:230°C max. and 30 sec max.at more than 210°C (Temp.at cap.surface)	

■ Construction

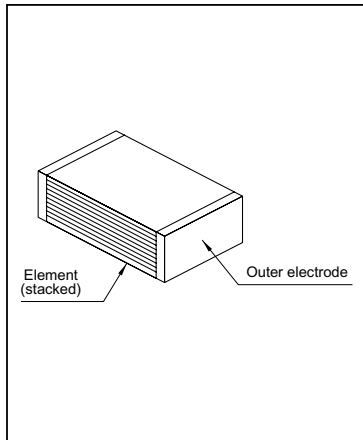

■ Dimensions in mm (not to scale)

Size code	L	Tol.	W	Tol.	H	Tol.
E1	4.8		3.3		1.4	
E2	4.8		3.3		2.0	
E3a	4.8		3.3		2.4	
E3	4.8		3.3		2.8	
D1	6.0	± 0.2	4.1	± 0.3	1.8	± 0.2
D2	6.0		4.1		2.0	
D3	6.0		4.1		2.4	
D4	6.0		4.1		2.8	
D5	6.0		4.1		3.2	
B	6.0		5.0			
Z	7.1		5.0			
X	7.7	± 0.4	5.5	± 0.4	*	± 0.3
Y	7.1		6.3			
V	9.8	± 0.5	6.3	± 0.4	*	± 0.3
U	9.8		8.0			
T	15.2		8.0			
S	15.2		10.0			

0.35±0.2 0.35±0.2

*Refer to the column "Rating, Dimensions & Quantity".

■ Taping Specification for Automatic Insertion(Mounting)

Refer to the PDF file of taping specifications.

■ Rating, Dimensions & Quantity/Reel

● Capacitance tolerance : ± 5% (J)

Cap. (μF)	Rated volt. 16VDC						Rated volt. 50VDC					
	Part No	Dimensions (mm)			Size code	Q'ty	Part No	Dimensions (mm)			Size code	Q'ty
		L	W	H				L	W	H		
0.056						ECWU1H563JC9	4.8	3.3	2.0	E2	3000	
0.068						ECWU1H683JC9	4.8	3.3	2.0	E2		
0.082						ECWU1H823JC9	4.8	3.3	2.4	E3a		
0.1						ECWU1H104JC9	4.8	3.3	2.8	E3		
0.12	ECWU1C124JC9	4.8	3.3	1.4	E1	3000	ECWU1H124JC9	6.0	4.1	1.8	D1	
0.15	ECWU1C154JC9	4.8	3.3	2.0	E2		ECWU1H154JC9	6.0	4.1	2.0	D2	
0.18	ECWU1C184JC9	4.8	3.3	2.0	E2	2000	ECWU1H184JC9	6.0	4.1	2.4	D3	
0.22	ECWU1C224JC9	4.8	3.3	2.4	E3a		ECWU1H224JC9	6.0	4.1	2.8	D4	
0.27	ECWU1C274JC9	6.0	4.1	1.8	D1	3000						
0.33	ECWU1C334JC9	6.0	4.1	2.0	D2							
0.39	ECWU1C394JC9	6.0	4.1	2.4	D3	2000						
0.47	ECWU1C474JC9	6.0	4.1	2.8	D4							

■ Example for Land Dimensions (mm)

Size code	Land dimensions		
	Reflow soldering		
	A	B	C
E1, E2, E3a, E3	2.6	6.6	3.0
D1, D2, D3, D4, D5	3.8	7.8	3.8
B	3.8	7.8	4.6
Z	4.5	9.0	4.6
X	5.1	9.7	5.0
Y	4.5	9.0	5.7
V	7.2	11.9	5.7
U	7.2	11.9	7.2
T	12.6	17.3	7.2
S	12.6	17.3	9.0

■ Rating, Dimensions & Quantity/Reel

● Capacitance tolerance : ±5% (J), ±10% (K)

Cap. (μF)	Rated volt. 100VDC						Rated volt. 250VDC					
	Part No	Dimensions (mm)			Size code	Q'ty	Part No	Dimensions (mm)			Size code	Q'ty
		L	W	H				L	W	H		
0.001	Please use 100VDC rating ECWU(X)						ECWU2102KC9	4.8	3.3	1.4	E1	3000
0.0012							ECWU2122KC9	4.8	3.3	1.4	E1	
0.0015							ECWU2152KC9	4.8	3.3	1.4	E1	
0.0018							ECWU2182KC9	4.8	3.3	1.4	E1	
0.0022							ECWU2222KC9	4.8	3.3	1.4	E1	
0.0027							ECWU2272KC9	4.8	3.3	1.4	E1	
0.0033							ECWU2332KC9	4.8	3.3	1.4	E1	
0.0039							ECWU2392KC9	4.8	3.3	1.4	E1	
0.0047							ECWU2472KC9	4.8	3.3	1.4	E1	
0.0056							ECWU2562KC9	4.8	3.3	1.4	E1	
0.0068							ECWU2682KC9	4.8	3.3	1.4	E1	
0.0082							ECWU2822KC9	4.8	3.3	1.4	E1	
0.01							ECWU2103KC9	4.8	3.3	1.4	E1	
0.012							ECWU1123 C9	4.8	3.3	1.4	E1	
0.015	ECWU1153 C9	4.8	3.3	1.4	E1	ECWU2153KC9	4.8	3.3	1.4	E1		
0.018	ECWU1183 C9	4.8	3.3	1.4	E1	ECWU2183KC9	4.8	3.3	2.0	E2		
0.022	ECWU1223 C9	4.8	3.3	1.4	E1	ECWU2223KC9	4.8	3.3	2.0	E2		
0.027	ECWU1273 C9	4.8	3.3	1.4	E1	ECWU2273KC9	4.8	3.3	2.4	E3a		
0.033	ECWU1333 C9	4.8	3.3	1.4	E1	ECWU2333KC9	4.8	3.3	2.8	E3		
0.039	ECWU1393 C9	4.8	3.3	1.4	E1	ECWU2393KC9	6.0	4.1	2.0	D2		
0.047	ECWU1473 C9	4.8	3.3	2.0	E2	ECWU2473KC9	6.0	4.1	2.4	D3		
0.056	ECWU1563 C9	4.8	3.3	2.0	E2	ECWU2563KC9	6.0	4.1	2.8	D4		
0.068	ECWU1683 C9	4.8	3.3	2.4	E3a	ECWU2683KC9	6.0	4.1	3.2	D5		
0.082	ECWU1823 C9	4.8	3.3	2.8	E3	ECWU2823KC9	6.0	5.0	3.2	B		
0.1	ECWU1104 C9	6.0	4.1	1.8	D1	ECWU2104KC9	6.0	5.0	3.8	B		
0.12	ECWU1124 C9	6.0	4.1	2.4	D3	ECWU2124KCV	7.1	6.3	2.8	Y		
0.15	ECWU1154 C9	6.0	4.1	2.8	D4	ECWU2154KCV	7.1	6.3	3.5	Y		
0.18	ECWU1184KC9	7.1	5.0	2.0	Z	ECWU2184KCV	7.1	6.3	4.1	Y		
0.22	ECWU1224KC9	7.1	5.0	2.4	Z	ECWU2224KCV	7.1	6.3	5.1	Y		
0.27	ECWU1274KC9	7.1	5.0	2.9	Z	ECWU2274KCV	9.8	6.3	3.9	V		
0.33	ECWU1334KC9	7.1	5.0	3.5	Z	ECWU2334KCV	9.8	6.3	4.8	V		
0.39	ECWU1394KCV	7.7	5.5	3.4	X	ECWU2394KCV	9.8	8.0	4.4	U		
0.47	ECWU1474KCV	7.7	5.5	4.0	X	ECWU2474KCV	9.8	8.0	5.3	U		
0.56	ECWU1564KCV	9.8	6.3	3.0	V	ECWU2564KCZ	15.2	8.0	3.7	T		
0.68	ECWU1684KCV	9.8	6.3	3.6	V	ECWU2684KCZ	15.2	8.0	4.4	T		
0.82	ECWU1824KCV	9.8	6.3	4.3	V	ECWU2824KCZ	15.2	10.0	4.2	S		
1.0	ECWU1105KCV	9.8	6.3	5.1	V	ECWU2105KCZ	15.2	10.0	5.1	S		

Capacitance tolerance code

* Please consult us for capacitance tolerance ± 5%(J).

ECWU (C) Type DC100V series (Stacked Metallized Film)

Electrical Characteristics < Typical Data >

Temperature Characteristics

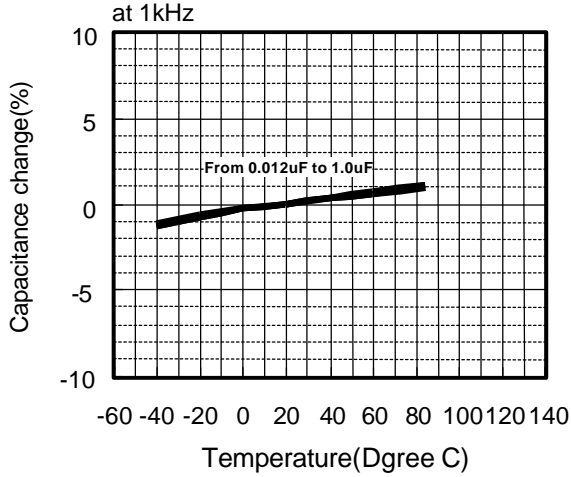

Frequency Characteristics

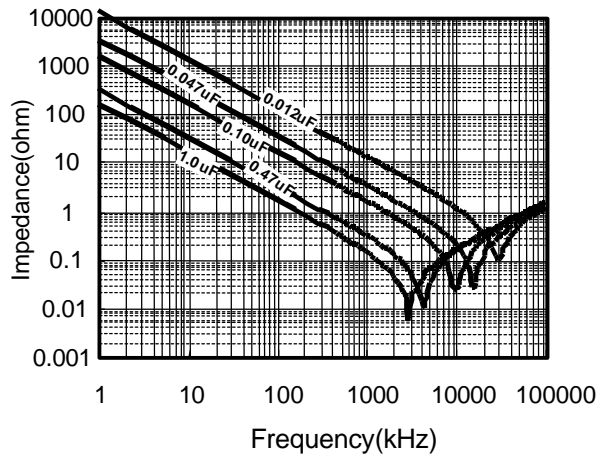
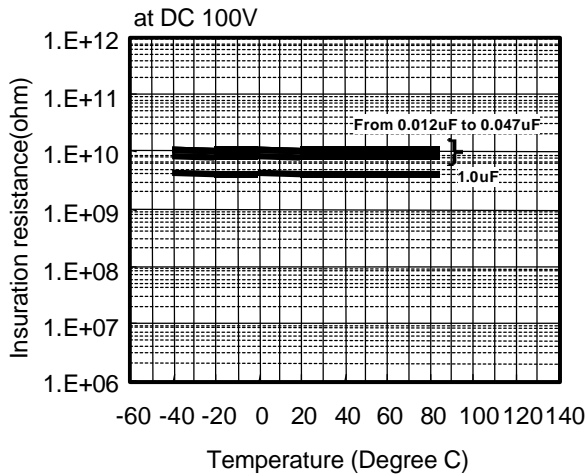
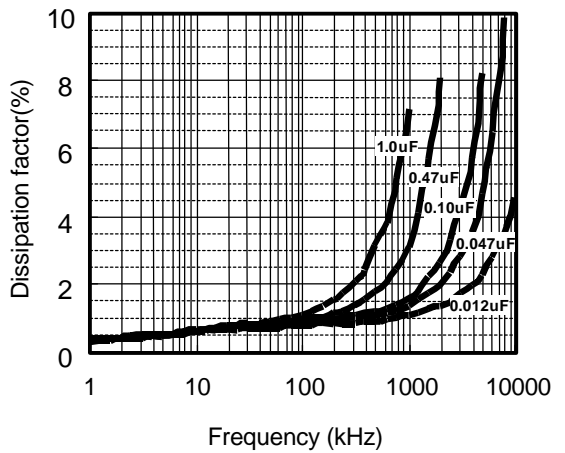
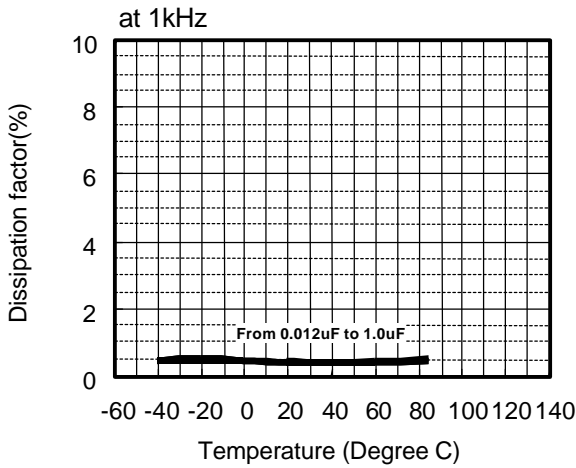
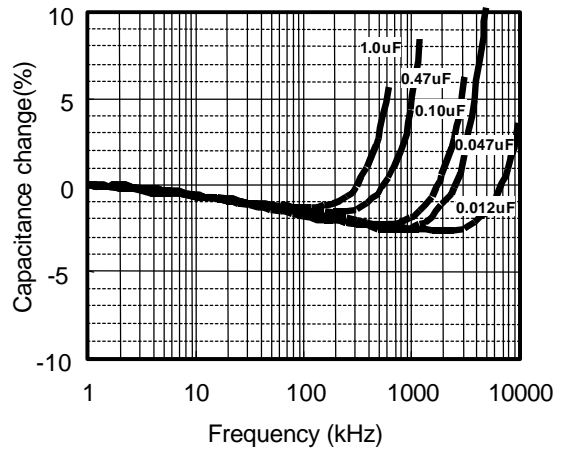

ECWU (C) Type DC100V series (Stacked Metallized Film)

Applicable Specifications

Permissible current

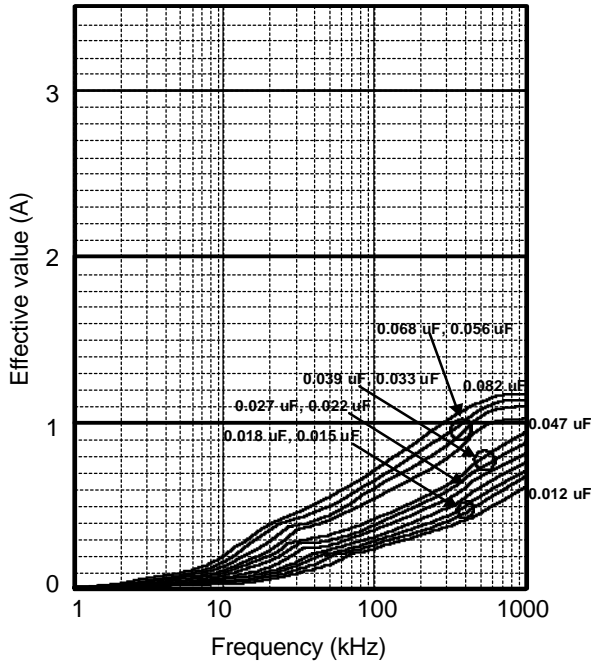

Permissible current

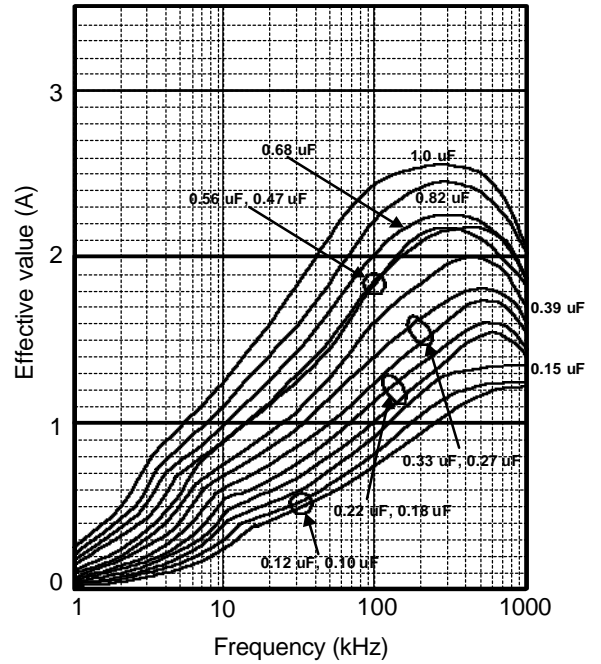

Permissible voltage (at sine wave)

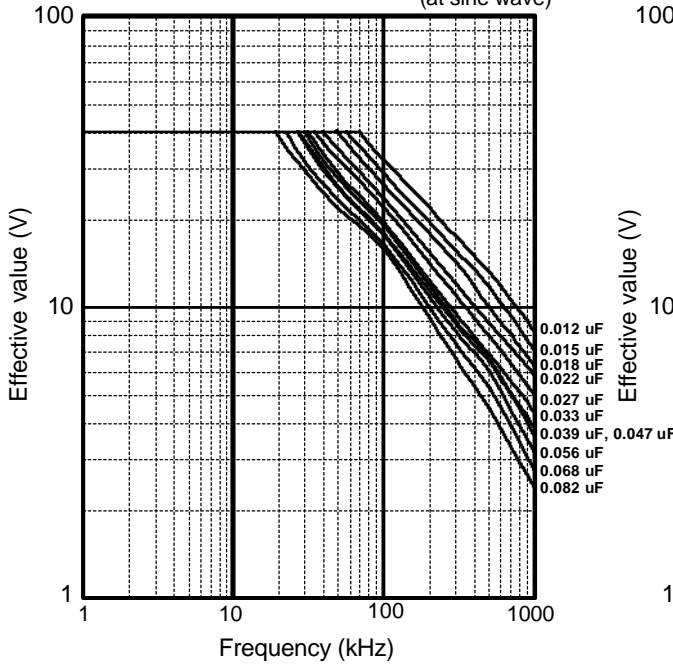

Permissible voltage (at sine wave)

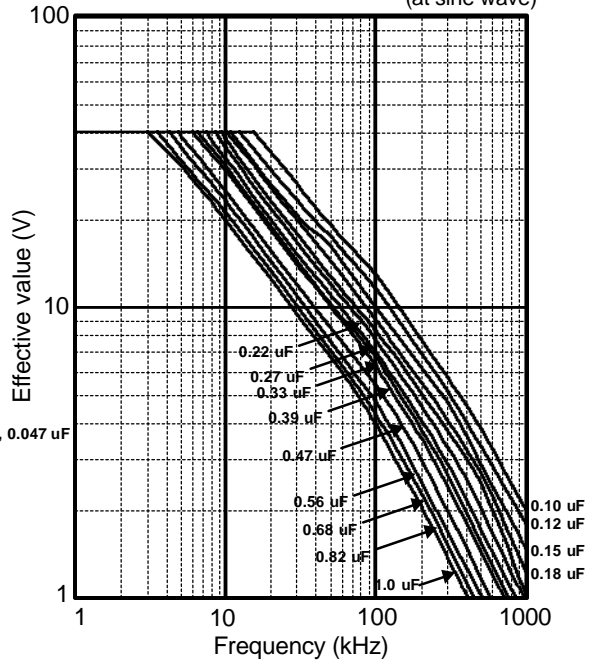

* Please consult Panasonic if your condition exceeds the above spec.

*Permissible voltage graph is the case of sine waveform. When you use this product, peak voltage must not exceed DC rated voltage.

*The current value (Aop) is calculated using "nominal capacitance." In fact, it changes by the tolerance of a capacitance value, capacitance change, etc.



ECWU (C) Type DC100V series (Stacked Metallized Film)

Applicable Specifications

Pulse Handling Capability (dv/dt)
(Max 10000cycles)

Rating Voltage	Capacitance Value(uF)	Code	dv/dt(V/us)	Current _(o,p) (A)
DC 100V	0.012	123	320	3.8
	0.015	123		4.8
	0.018	183		5.8
	0.022	223		7.0
	0.027	273		8.6
	0.033	333		10.6
	0.039	393		12.5
	0.047	473		15.0
	0.056	563		17.9
	0.68	683		21.8
	0.82	823		26.2

Pulse Handling Capability (dv/dt)
(Max 10000cycles)

Rating Voltage	Capacitance Value(uF)	Code	dv/dt(V/us)	Current _(o,p) (A)
DC 100V	0.10	104	210	21.0
	0.12	124		25.2
	0.15	154		31.5
	0.18	184	120	21.6
	0.22	224		26.4
	0.27	274		32.4
	0.33	334		39.6
	0.39	394	100	39.0
	0.47	474		47.0
	0.56	564	70	39.2
	0.68	684		47.6
	0.82	824		57.4
	1.0	105		70.0

Voltage Derating by Temperature

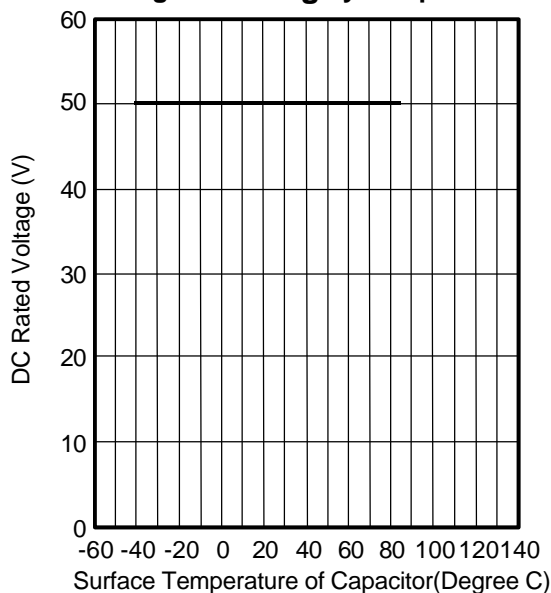

* Please consult Panasonic if your condition exceeds the above spec.

*Permissible voltage graph is the case of sine waveform. When you use this product, peak voltage must not exceed DC rated voltage.

*The current_(o,p) value is calculated using nominal capacitance.



ECWU (C) Type DC16V series (Stacked Metallized Film)

Electrical Characteristics < Typical Data >

Temperature Characteristics

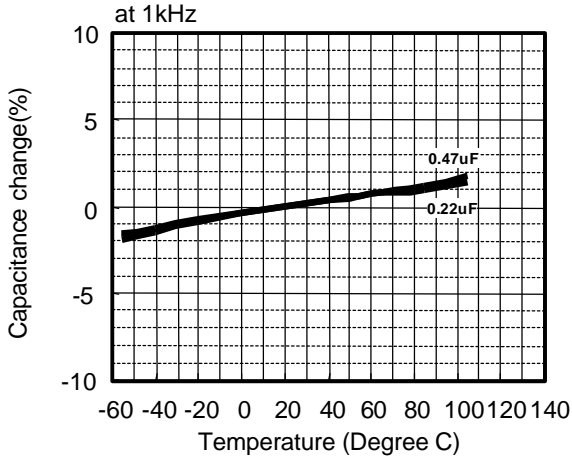

Frequency Characteristics

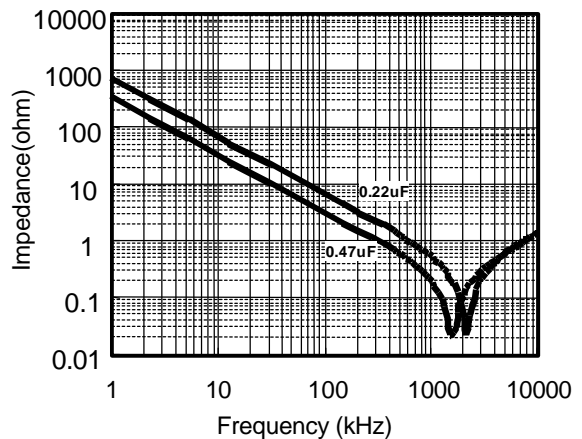
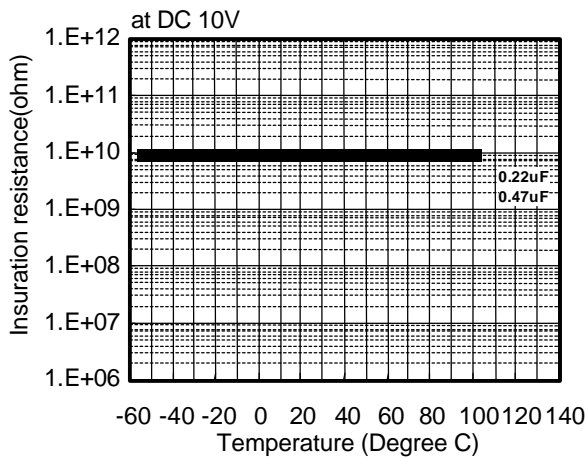
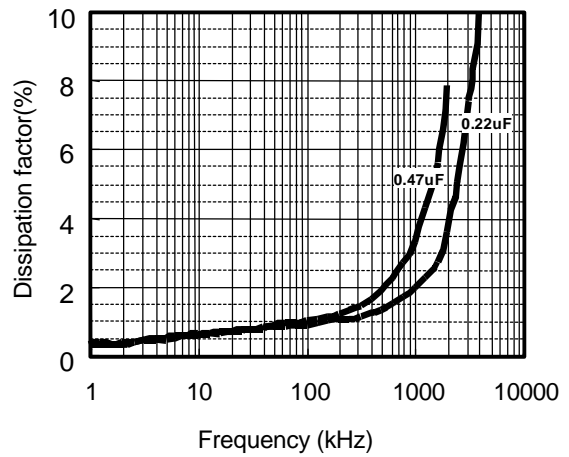
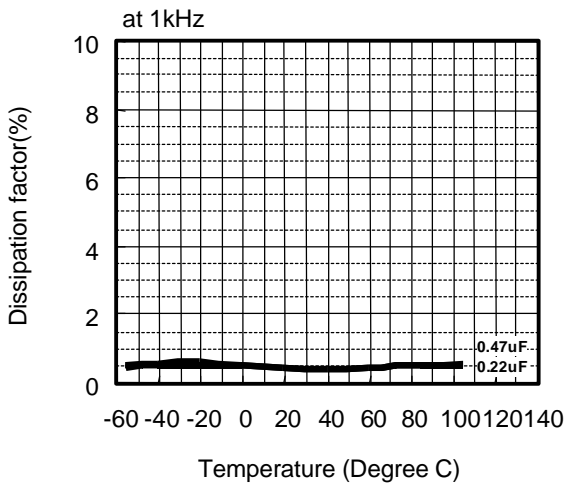
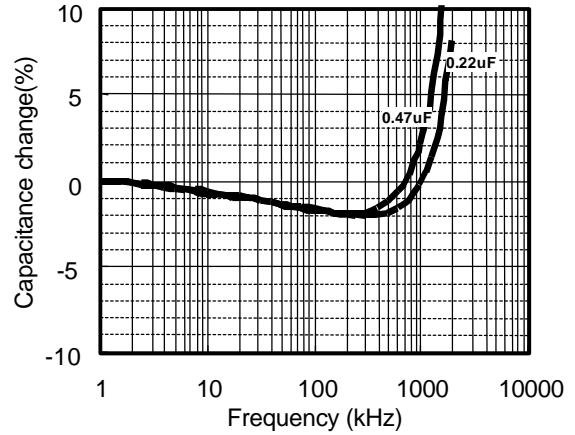

ECWU (C) Type DC16V series (Stacked Metallized Film)

Applicable Specifications

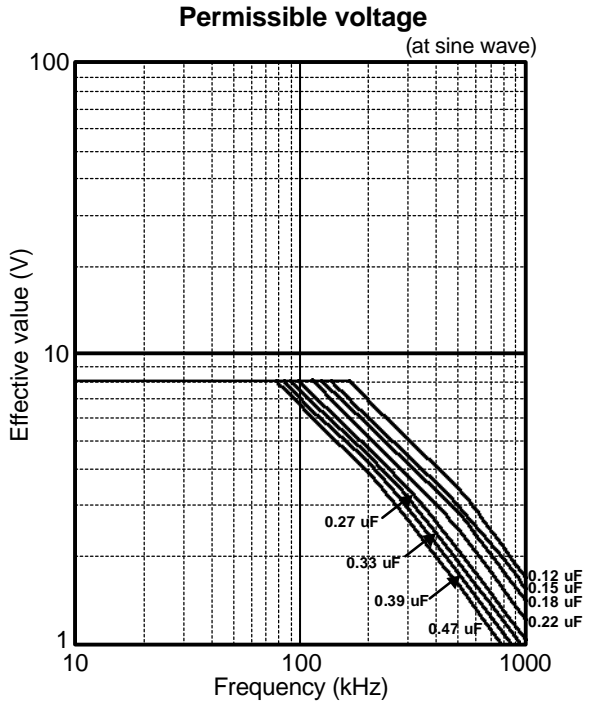
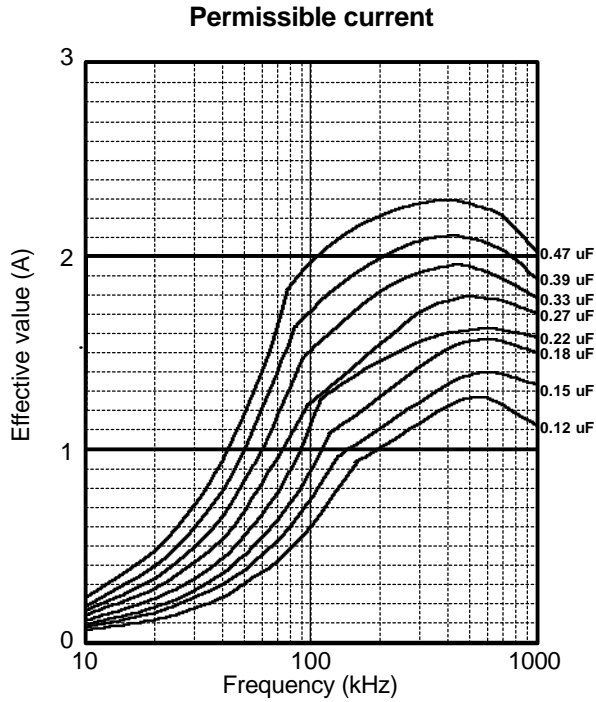

**Pulse Handling Capability (dv/dt)
(Max 10000cycles)**

Rating Voltage	Capacitance Value(uF)	Code	dv/dt(V/us)	Current _(o,p) (A)
DC 16V	0.12	124	60	7.2
	0.15	154		9.0
	0.18	184		10.8
	0.22	224		13.2
	0.27	274	40	10.8
	0.33	334		13.2
	0.39	394		15.6
	0.47	474		18.8

Voltage Derating by Temperature

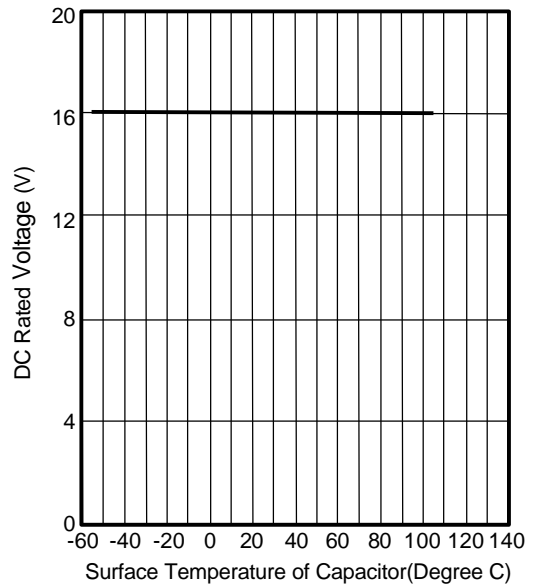

* Please consult Panasonic if your condition exceeds the above spec.
 *Permissible voltage graph is the case of sine waveform. When you use this product, peak voltage must not exceed DC rated voltage.
 *The current_(o,p) value is calculated using nominal capacitance.

ECWU (C) Type DC50V series (Stacked Metallized Film)

Electrical Characteristics < Typical Data >

Temperature Characteristics

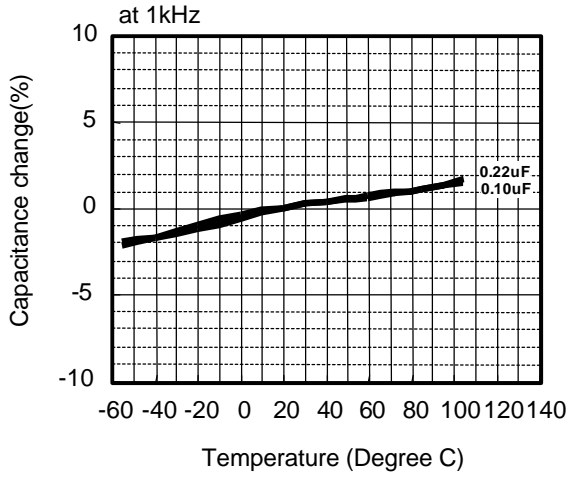

Frequency Characteristics

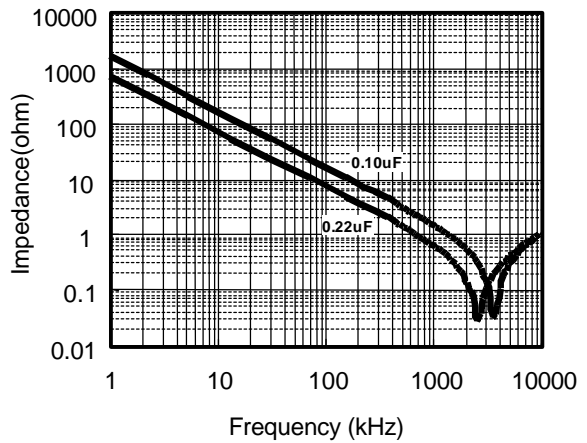
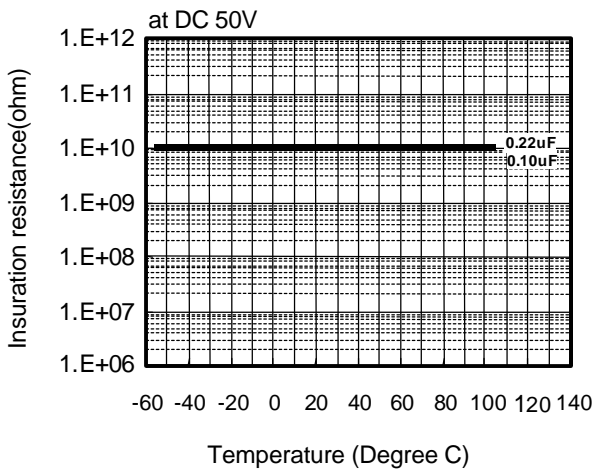
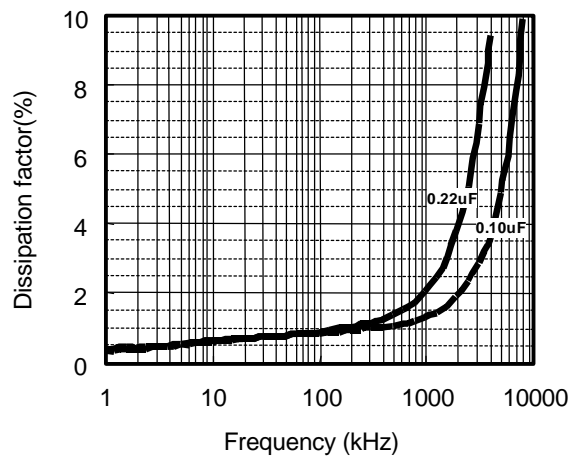
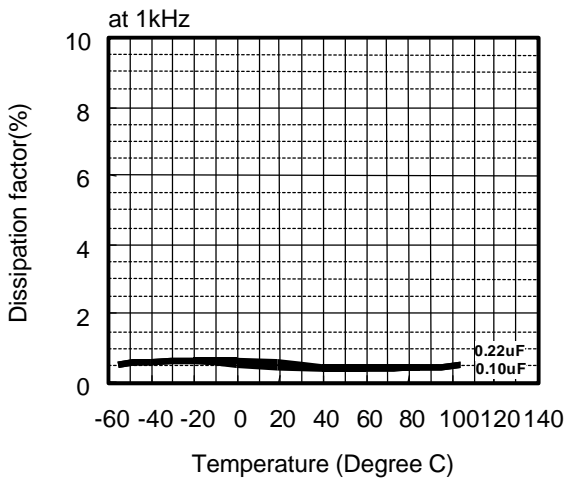
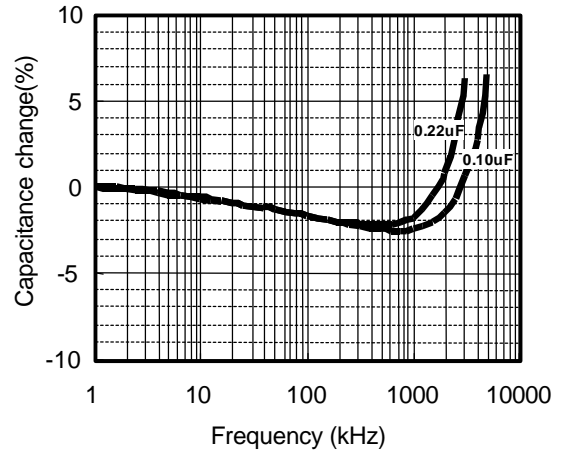

ECWU (C) Type DC50V series (Stacked Metallized Film)

Applicable Specifications

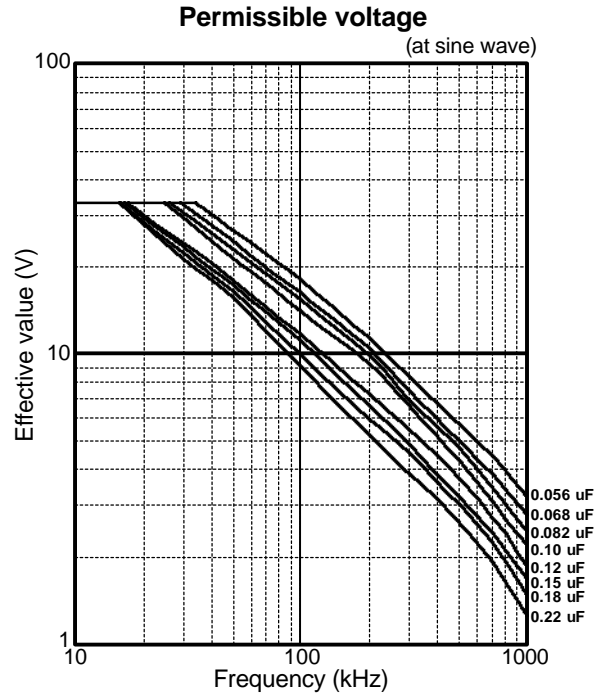
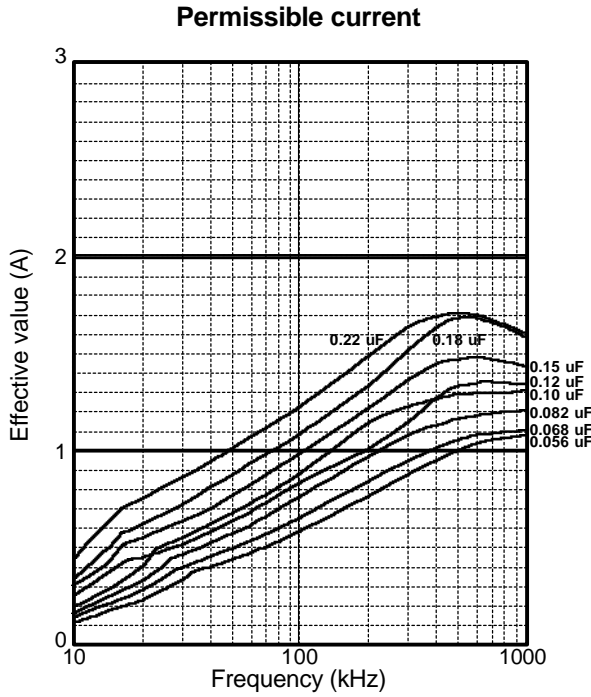

**Pulse Handling Capability (dv/dt)
(Max 10000cycles)**

Rating Voltage	Capacitance Value(uF)	Code	dv/dt(V/us)	Current(I _{0-P}) (A)
DC 50V	0.056	563	190	10.6
	0.068	683		12.9
	0.082	823		15.6
	0.10	104		19.0
	0.12	124	130	15.6
	0.15	154		19.5
	0.18	184		23.4
	0.22	224		28.6

Voltage Derating by Temperature

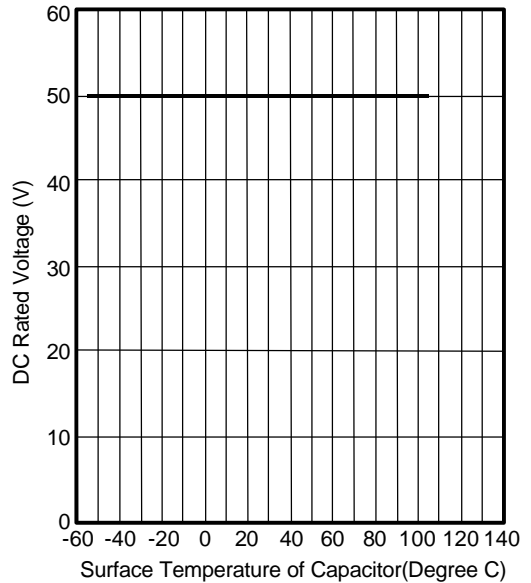

* Please consult Panasonic if your condition exceeds the above spec.

*Permissible voltage graph is the case of sine waveform. When you use this product, peak voltage must not exceed DC rated voltage.

*The current(I_{0-P}) value is calculated using nominal capacitance.

ECWU (C) Type DC250V series (Stacked Metallized Film)

Electrical Characteristics < Typical Data >

Temperature Characteristics

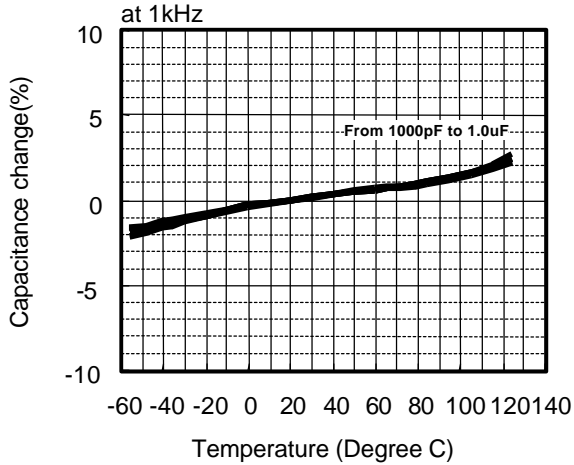

Frequency Characteristics

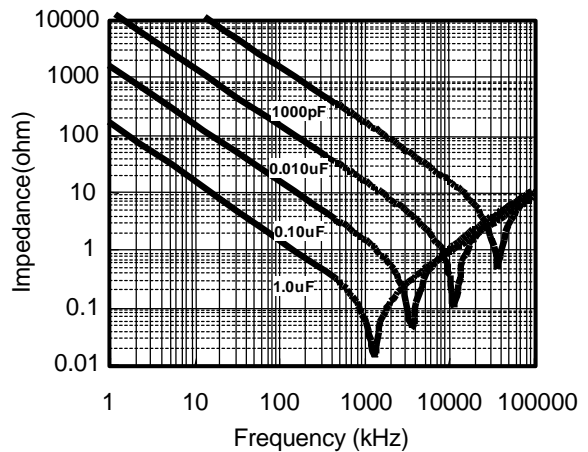
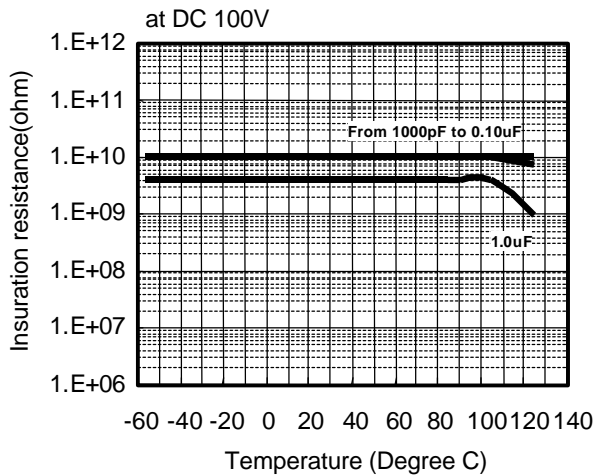
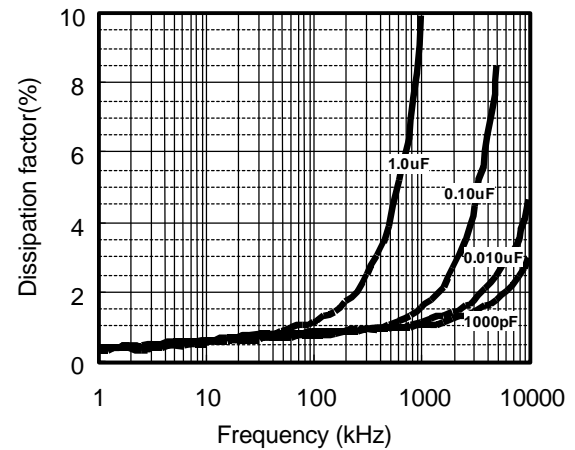
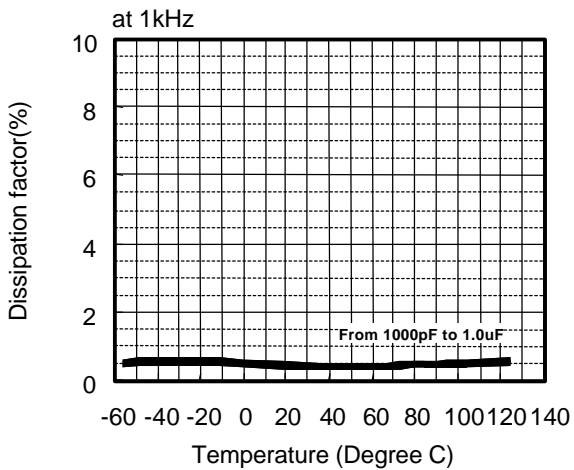
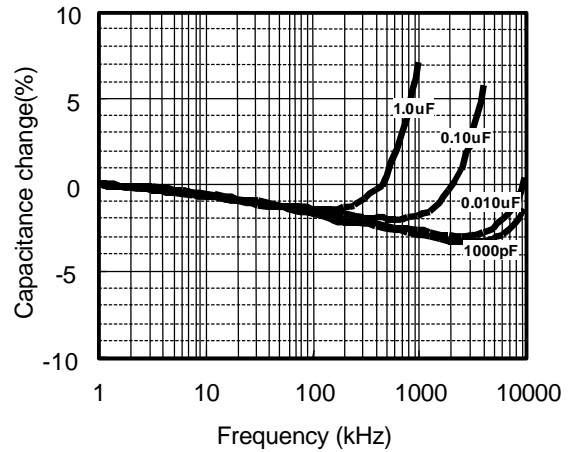

ECWU (C) Type DC250V series (Stacked Metallized Film)

Applicable Specifications

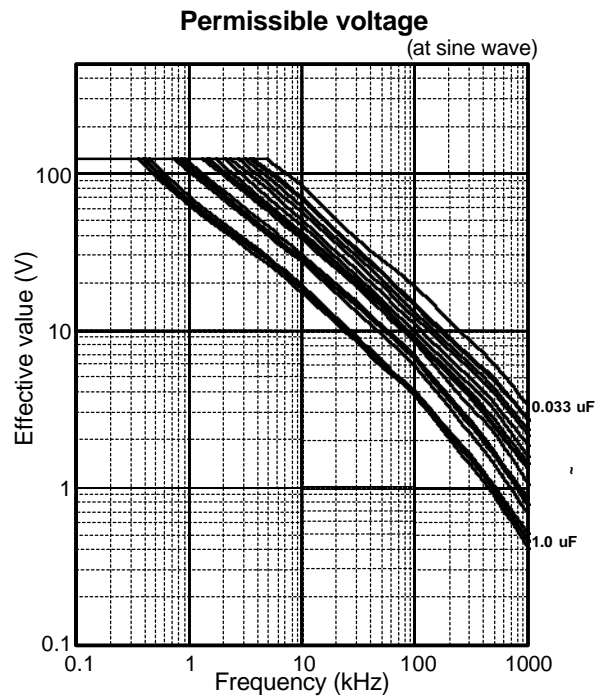
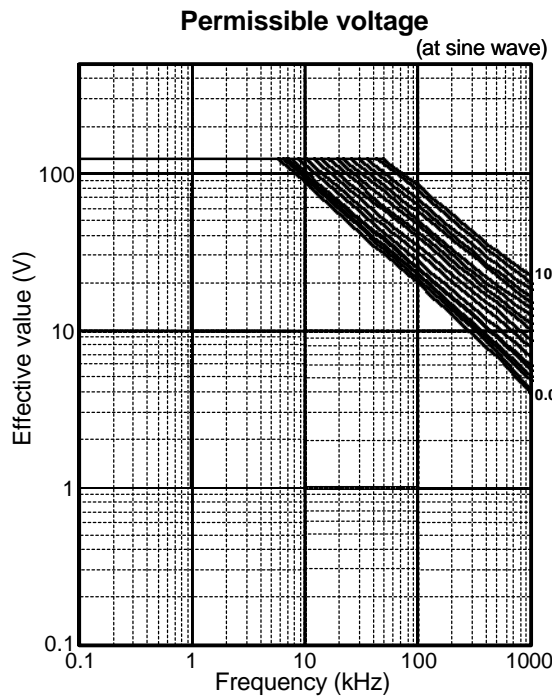
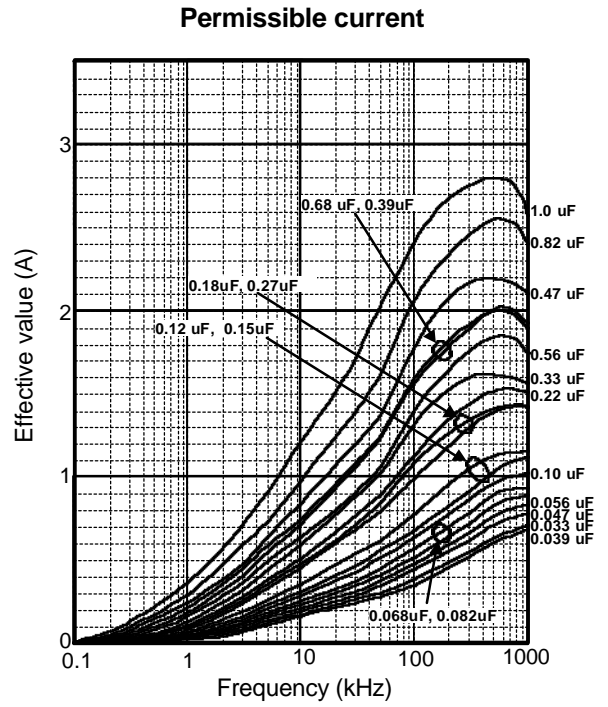
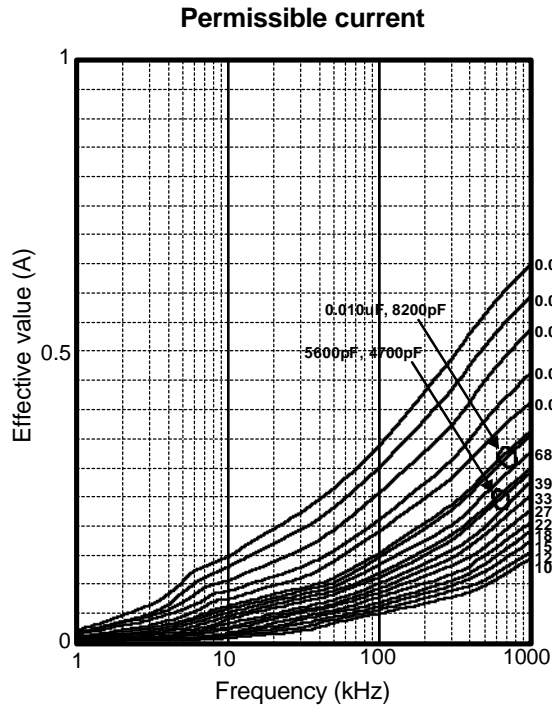

* Please consult Panasonic if your condition exceeds the above spec.

*Permissible voltage graph is the case of sine waveform. When you use this product, peak voltage must not exceed DC rated voltage.

*The current_(0-P) value is calculated using nominal capacitance.



ECWU (C) Type DC250V series (Stacked Metallized Film)

Applicable Specifications

Pulse Handling Capability (dv/dt) (Max 10000cycles)

Rating Voltage	Capacitance Value(uF)	Code	dv/dt(V/us)	Current _(o,p) (A)
DC 250V	0.0010	102	615	0.62
	0.0012	122		0.74
	0.0015	152		0.92
	0.0018	182		1.11
	0.0022	222		1.35
	0.0027	272		1.66
	0.0033	332		2.03
	0.0039	392		2.40
	0.0047	472	360	1.69
	0.0056	562		2.02
	0.0068	682		2.45
	0.0082	822		2.95
	0.010	103		3.60
	0.012	123		4.32
	0.015	153		5.40
	0.018	183		6.48
	0.022	223		7.92
	0.027	273		9.72
	0.033	333		11.88

Rating Voltage	Capacitance Value(uF)	Code	dv/dt(V/us)	Current _(o,p) (A)
DC 250V	0.039	393	240	9.36
	0.047	473		11.28
	0.056	563		13.44
	0.068	683		16.32
	0.082	823		19.68
	0.10	104		24.00
	0.12	124		28.80
	0.15	154		190
	0.18	184	34.20	
	0.22	224	41.80	
	0.27	274	115	
	0.33	334		37.95
	0.39	394		44.85
	0.47	474		54.05
	0.56	564	65	36.40
	0.68	684		44.20
	0.82	824		53.30
	1.0	105		65.00

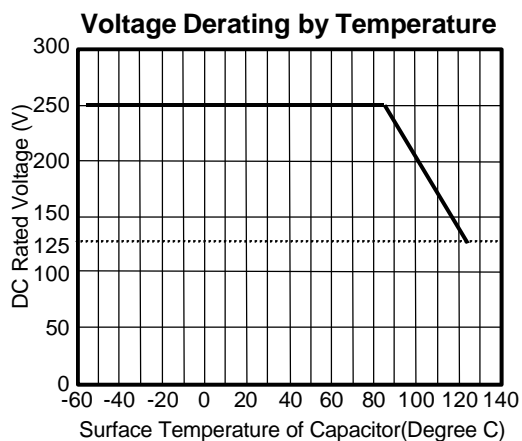

* Please consult Panasonic if your condition exceeds the above spec.

*Permissible voltage graph is the case of sine waveform. When you use this product, peak voltage must not exceed DC rated voltage.

*The current_(o,p) value is calculated using nominal capacitance.