

## 阅读申明

- 1.本站收集的数据手册和产品资料都来自互联网，版权归原作者所有。如读者和版权方有任何异议请及时告之，我们将妥善解决。
- 2.本站提供的中文数据手册是英文数据手册的中文翻译，其目的是协助用户阅读，该译文无法自动跟随原稿更新，同时也可能存在翻译上的不当。建议读者以英文原稿为参考以便获得更精准的信息。
- 3.本站提供的产品资料，来自厂商的技术支持或者使用者的心得体会等，其内容可能存在描述上的差异，建议读者做出适当判断。
- 4.如需与我们联系，请发邮件到marketing@iczoom.com，主题请标有“数据手册”字样。

## Read Statement

1. The datasheets and other product information on the site are all from network reference or other public materials, and the copyright belongs to the original author and original published source. If readers and copyright owners have any objections, please contact us and we will deal with it in a timely manner.
2. The Chinese datasheets provided on the website is a Chinese translation of the English datasheets. Its purpose is for reader's learning exchange only and do not involve commercial purposes. The translation cannot be automatically updated with the original manuscript, and there may also be improper translations. Readers are advised to use the English manuscript as a reference for more accurate information.
3. All product information provided on the website refer to solutions from manufacturers' technical support or users the contents may have differences in description, and readers are advised to take the original article as the standard.
4. If you have any questions, please contact us at marketing@iczoom.com and mark the subject with "Datasheets" .

## COMPONENT PERFORMANCE CHARACTERISTICS

### Introduction

KEMET has developed a new type of tantalum capacitor that replaces the solid manganese dioxide electrode with a solid conductive polymer. This product is named the KO-CAP for **KEMET Organic Capacitor**. The basic families are the T520 and T530 series. A separate detail of performance characteristics is presented here as there are some differences between the polymer tantalums and the standard MnO<sub>2</sub> types. Like all KEMET tantalum chips, these series are 100% screened for all electrical parameters: Capacitance @ 120 Hz, Dissipation Factor (DF) @ 120 Hz, ESR @ 100 kHz and DC Leakage. It is also 100% surge current tested at full rated voltage through a low impedance circuit. The advantages of the polymer include very low ESR and elimination of the potentially catastrophic failure mode that may occur with standard tantalum capacitors in a high surge current application. Although the natural KO-CAP series failure mechanism is a short circuit, it does not exhibit an explosive failure mode.

## ELECTRICAL

### 1. Operating Temperature Range

- -55°C to +105°C

Above 85°C, the voltage rating is reduced linearly from 1.0 x rated voltage to 0.8 x rated voltage at 105°C.

### 2. Non-Operating Temperature Range

- -55°C to +105°C

### 3. Capacitance and Tolerance

- 33µF to 1500µF
- ±20% Tolerance

Capacitance is measured at 120 Hz, up to 1.0 volt rms maximum and up to 2.5V DC maximum. DC bias causes only a small reduction in capacitance, up to about 2% when full rated voltage is applied. DC bias is not commonly used for room temperature measurements but is more commonly used when measuring at temperature extremes.

Capacitance does decrease with increasing frequency, but not nearly as much or as quickly as standard tantalums. Figure 1 compares the frequency induced cap roll-off between the KO-CAP and traditional MnO<sub>2</sub> types. Capacitance also increases with increasing temperature. See section 12 for temperature coefficients.

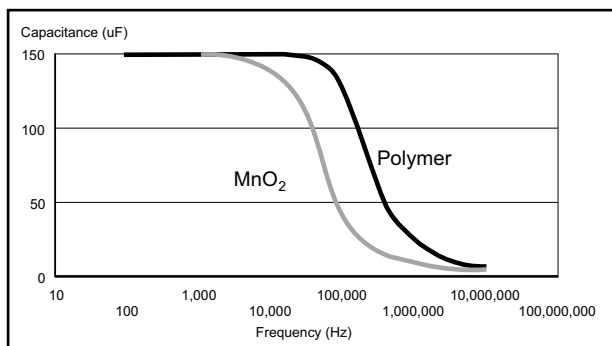

FIGURE 1

### 4. Voltage Ratings

- 2V-16V DC Rated Voltage

This is the maximum peak DC operating voltage from -55°C to +85°C for continuous duty. Above 85°C, this voltage is derated linearly to 0.8 times the rated voltage for operation at 105°C.

- Surge Voltage Ratings

Surge voltage is the maximum voltage to which the part can be subjected under transient conditions including the sum of peak AC ripple, DC bias and any transients. Surge voltage capability is demonstrated by application of 1000 cycles of the relevant voltage, at 25°C, 85°C or 105°C. The parts are charged through a 33 ohm resistor for 30 seconds and then discharged through a 33 ohm resistor for 30 seconds for each cycle.

#### • Voltage Ratings • Table 1

Rated Voltage	Surge Voltage	Derated Voltage	Derated Surge Voltage
-55°C to +85°C		+105°C	
2V	2.6V	1.6V	2.1V
2.5V	3.3V	2.0V	2.8V
3V	3.9V	2.4V	3.1V
4V	5.2V	3.3V	4.3V
6.3V	8V	5V	6.5V
8V	10.4V	6.4V	8.7V
10V	13V	8V	10.4V
16V	20.8V	12.8V	16.6V

### 5. Reverse Voltage Rating & Polarity

Polymer tantalum capacitors are polar devices and may be permanently damaged or destroyed if connected in the wrong polarity. The positive terminal is identified by a laser-marked stripe and may also include a beveled edge. These capacitors will withstand a small degree of transient voltage reversal for short periods as shown in the following table. Please note that these parts may not be operated continuously in reverse, even within these limits.

Table 2

Temperature	Permissible Transient Reverse Voltage
25°C	15% of Rated Voltage
55°C	10% of Rated Voltage
85°C	5% of Rated Voltage
105°C	3% of Rated Voltage

### 6. DC Leakage Current

Because of the high conductivity of the polymer, the KO-CAP family has higher leakage currents than traditional MnO<sub>2</sub> type Tantalum caps. The DC Leakage limits at 25°C are calculated as 0.1 x C x V, where C is cap in µF and V is rated voltage in Volts. Limits for all part numbers are listed in the ratings tables.

DC Leakage current is the current that flows through the capacitor dielectric after a five minute charging period at rated voltage. Leakage is measured at 25°C with full rated voltage applied to the capacitor through a 1000 ohm resistor in series with the capacitor.

## COMPONENT PERFORMANCE CHARACTERISTICS

DC Leakage current does increase with temperature. The limits for 85°C @ Rated Voltage and 105°C @ 0.8 x Rated Voltage are both 10 times the 25°C limit.

### 7. Surge Current Capability

Certain applications may induce heavy surge currents when circuit impedance is very low (<0.1 ohm per volt). Driving inductance may also cause voltage ringing. Surge currents may appear as transients during turn-on of equipment.

The KO-CAP has a very high tolerance for surge current. And although the failure mechanism is a short circuit, they do not explode as may occur with standard tantalums in such applications.

The KO-CAP series receives 100% screening for surge current in our production process. Capacitors are surged 4 times at full rated voltage applied through a total circuit resistance of <0.5 ohms. Failures are removed during subsequent electrical testing.

### 8. Dissipation Factor (DF)

Refer to part number tables for maximum DF limits.

Dissipation factor is measured at 120 Hz, up to 1.0 volt rms maximum, and up to 2.5 volts DC maximum at +25°C. The application of DC bias causes a small reduction in DF, about 0.2% when full rated voltage is applied. DF increases with increasing frequency.

Dissipation factor is the ratio of the equivalent series resistance (ESR) to the capacitive reactance, ( $X_c$ ) and is usually expressed as a percentage. It is directly proportional to both capacitance and frequency. Dissipation factor loses its importance at higher frequencies, (above about 1 kHz), where impedance ( $Z$ ) and equivalent series resistance (ESR) are the normal parameters of concern.

$$DF = \frac{R}{X_c} = 2 \pi f CR$$

DF= Dissipation Factor  
 R= Equivalent Series Resistance (Ohms)  
 $X_c$ = Capacitive Reactance (Ohms)  
 f= Frequency (Hertz)  
 C= Series Capacitance (Farads)

DF is also referred to as  $\tan \delta$  or "loss tangent." The "Quality Factor," "Q," is the reciprocal of DF.

### 9. Equivalent Series Resistance (ESR) and Impedance (Z)

The Equivalent Series Resistance (ESR) of the KO-CAP is much lower than standard Tantalum caps because the polymer cathode has much higher conductivity. ESR is not a pure resistance, and it decreases with increasing frequency.

Total impedance of the capacitor is the vector sum of capacitive reactance ( $X_c$ ) and ESR, below resonance; above resonance total impedance is the vector sum of inductive reactance ( $X_L$ ) and ESR.

$$X_c = \frac{1 \text{ ohm}}{2\pi f C}$$

where:  
 f = frequency, Hertz  
 C = capacitance, Farad

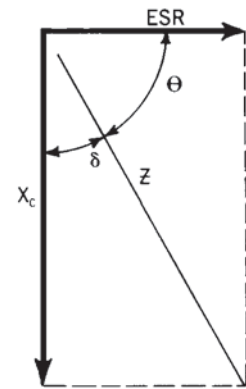

**FIGURE 2a Total Impedance of the Capacitor Below Resonance**

$$X_L = 2\pi f L$$

where:  
 f = frequency, Hertz  
 L = inductance, Henries

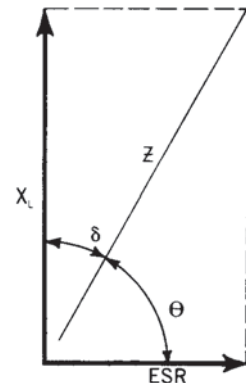

**FIGURE 2b Total Impedance of the Capacitor Above Resonance**

To understand the many elements of a capacitor, see Figure 3.

## COMPONENT PERFORMANCE CHARACTERISTICS

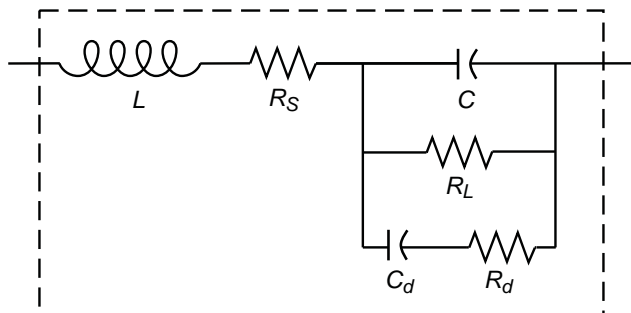

FIGURE 3 The Real Capacitor

A capacitor is a complex impedance consisting of many series and parallel elements, each adding to the complexity of the measurement system.

$L$  — Represents lead wire and construction inductance. In most instances (especially in solid tantalum and monolithic ceramic capacitors) it is insignificant at the basic measurement frequencies of 120 and 1000 Hz.

$R_S$  — Represents the actual ohmic series resistance in series with the capacitance. Lead wires and capacitor electrodes are contributing sources.

$R_L$  — Capacitor Leakage Resistance. Typically it can reach 50,000 megohms in a tantalum capacitor. It can exceed  $10^{12}$  ohms in monolithic ceramics and in film capacitors.

$R_d$  — The dielectric loss contributed by dielectric absorption and molecular polarization. It becomes very significant in high frequency measurements and applications. Its value varies with frequency.

$C_d$  — The inherent dielectric absorption of the solid tantalum capacitor which typically equates to 1-2% of the applied voltage.

As frequency increases,  $X_c$  continues to decrease according to its equation above. There is unavoidable inductance as well as resistance in all capacitors, and at some point in frequency, the reactance ceases to be capacitive and becomes inductive. This frequency is called the self-resonant point. In solid tantalum capacitors, the resonance is damped by the ESR, and a smooth, rather than abrupt, transition from capacitive to inductive reactance follows.

Figure 4 compares the frequency response of a KO-CAP to a standard Tantalum chip. See also frequency curves shown in the T520 section, p.39. Maximum limits for 100 kHz ESR are listed in the part number tables for each series.

The T530 Capacitance, Impedance and ESR vs. Frequency Comparisons are located on page 43. Maximum limits for 100 kHz are listed in the part number table on page 42.

### ESR and Impedance

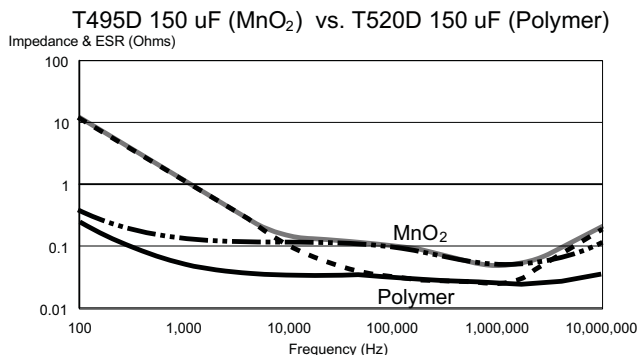

FIGURE 4

### 10. AC Power Dissipation

Power dissipation is a function of capacitor size and materials. Maximum power ratings have been established for all case sizes to prevent overheating. In actual use, the capacitor's ability to dissipate the heat generated at any given power level may be affected by a variety of circuit factors. These include board density, pad size, heat sinks and air circulation.

Table 3  
Tantalum Chip Power Dissipation Ratings

Case Code		Maximum Power Dissipation mWatts @ +25°C w/+20°C Rise
KEMET	EIA	
T520/T	3528-12	70
T520/B	3528-21	85
T520/V	7343-20	125
T520/D	7343-31	150
T520/Y	7343-40	156
T520/X	7343-43	165
T530/D	7343-31	255
T530/X	7343-43	270
T530/E	7260-38	285

### 11. AC Operation

Permissible AC ripple voltage and current are related to equivalent series resistance (ESR) and power dissipation capability.

Permissible AC ripple voltage which may be applied is limited by three criteria:

- The positive peak AC voltage plus the DC bias voltage, if any, must not exceed the DC voltage rating of the capacitor.
- The negative peak AC voltage, in combination with bias voltage, if any, must not exceed the permissible reverse voltage ratings presented in Section 5.
- The power dissipated in the ESR of the capacitor must not exceed the appropriate value specified in Section 10.

Polymer Tantalum Surface Mount

## COMPONENT PERFORMANCE CHARACTERISTICS

Actual power dissipated may be calculated from the following:

$$P = I^2R$$

$$\text{Substituting } I = \frac{E}{Z}, \quad P = \frac{E^2R}{Z^2}$$

where:

I = rms ripple current (amperes)

E = rms ripple voltage (volts)

P = power (watts)

Z = impedance at specified frequency (ohms)

R = equivalent series resistance at specified frequency (ohms)

Using P max from Table 3, maximum allowable rms ripple current or voltage may be determined as follows:

$$I(\text{max}) = \sqrt{P \text{ max}/R} \quad E(\text{max}) = Z \sqrt{P \text{ max}/R}$$

These values should be derated at elevated temperatures as follows:

Temperature	Derating Factor
85°C	.9
105°C	.4

## ENVIRONMENTAL

### 12. Temperature Stability

Mounted capacitors withstand extreme temperature testing at a succession of continuous steps at +25°C, -55°C, +25°C, +85°C, +105°C, +25°C in that order. Capacitors are allowed to stabilize at each temperature before measurement. Cap, DF, and DCL are measured at each temperature except DC Leakage is not measured at -55°C.

Table 4

Acceptable limits are as follows:

Step	Temp.	ΔCap	DCL	DF
1	+25°C	Specified Tolerance	Catalog Limit	Catalog Limit
2	-55°C	±20% of initial value	N/A	Catalog Limit
3	+25°C	±10% of initial value	Catalog Limit	Catalog Limit
4	+85°C	±20% of initial value	10x Catalog Limit	1.2x Catalog Limit
5	+105°C	±30% of initial value	10x Catalog Limit	1.5x Catalog Limit
6	+25°C	±10% of initial value	Catalog Limit	Catalog Limit

### 13. Standard Life Test

• 85°C, Rated Voltage, 2000 Hours

Post Test Performance:

- Capacitance: within -20%/+10% of initial value
- DF: within initial limit
- DC Leakage: within initial limit
- ESR: within initial limit

### 14. High Temperature Life Test

• 105°C, 0.8 x Rated Voltage, 2000 hours

Post Test Performance:

- Capacitance: within -20%/+10% of initial value
- DF: within initial limit
- DC Leakage: within 1.25 x initial limit
- ESR: within 2 x initial limit

### 15. Storage Life Test

• 105°C, 0VDC, 2000 Hours

Post Test Performance:

- Capacitance: within -20%/+10% of initial value
- DF: within initial limit
- DC Leakage: within 1.25 x initial limit
- ESR: within 2 x initial limit

### 16. Thermal Shock

• Mil-Std-202, Method 107, Condition B

Minimum temperature is -55°C

Maximum temperature is +105°C

500 Cycles

Post Test Performance:

- Capacitance: within +10%/-20% of initial value
- DF: within initial limit
- DC Leakage: within initial limit
- ESR: within 2 x initial limit

### 17. Moisture Resistance Testing

• J-Std-020

Steps 7a and 7b excluded, 0V, 21 cycles

Post Test Performance:

- Capacitance: within ±30% of initial value
- DF: within initial limit
- DC Leakage: within initial limit
- ESR: within initial limit

### 18. Load Humidity

• 85°C, 85% RH, Rated Voltage, 500 Hours

Post Test Performance:

- Capacitance: within +35%/-5% of initial value
- DF: within initial limit
- DC Leakage: within 5 x initial limit
- ESR: within 2 x initial limit

### 19. ESD

• Polymer tantalum capacitors are not sensitive to Electro-Static Discharge (ESD).

### 20. Failure Mechanism and Reliability

The normal failure mechanism is dielectric breakdown. Dielectric failure can result in high DC Leakage current and may proceed to the level of a short circuit. With sufficient time to charge, healing may occur by one of two potential mechanisms. The polymer adjacent to the dielectric fault site may overheat and vaporize, disconnecting the fault site from the circuit. The polymer may also

## COMPONENT PERFORMANCE CHARACTERISTICS

oxidize into a more resistive material that plugs the defect site in the dielectric and reduces the flow of current.

Capacitor failure may be induced by exceeding the rated conditions of forward DC voltage, reverse DC voltage, surge current, power dissipation or temperature. Excessive environmental stress, such as prolonged or high temperature reflow processes may also trigger dielectric failure.

Failure rates may be improved in application by derating the voltage applied to the capacitor. KEMET recommends that KO-CAPS be derated to 80% or less of the rated voltage in application.

KO-CAPS exhibit a benign failure mode in that they do not fail catastrophically even under typical fault conditions. If a shorted capacitor is allowed to pass unlimited current, it may overheat and the case may discolor. But this is distinctly different from the explosive "ignition" that may occur with standard MnO<sub>2</sub> cathode tantalums. Replacement of the MnO<sub>2</sub> by the polymer removes the oxygen that fuels ignition during a failure event.

### MECHANICAL

#### 21. Resistance to Solvents

- Mil-Std-202, Method 215

Post Test Performance:

- Capacitance — within ±10% of initial value
- DC Leakage — within initial limit
- Dissipation Factor — within initial limit
- ESR — within initial limit
- Physical — no degradation of case, terminals or marking

#### 22. Fungus

- Mil-Std-810, Method 508

#### 23. Flammability

- UL94 VO Classification

Encapsulant materials meet this classification

#### 24. Resistance to Soldering Heat

- Maximum Reflow  
+240 ±5°C, 10 seconds
- Typical Reflow  
+230 ±5°C, 30 seconds

Post Test Performance:

- Capacitance — within ±10% of initial value
- DC Leakage — within initial limit
- Dissipation Factor — within initial limit
- ESR — within initial limit

#### 25. Solderability

- Mil-Std-202, Method 208
- ANSI/J-STD-002, Test B

Applies to Solder Coated terminations only.

#### 26. Vibration

- Mil-Std-202, Method 204, Condition D, 10 Hz to 2,000 Hz, 20G Peak

Post Test Performance:

- Capacitance — within ±10% of initial value
- DC Leakage — within initial limit
- Dissipation Factor — within initial limit
- ESR — within initial limit

#### 27. Shock

- Mil-Std-202, Method 213, Condition I, 100 G Peak

Post Test Performance:

- Capacitance — within ±10% of initial value
- DC Leakage — within initial limit
- Dissipation Factor — within initial limit
- ESR - within initial limit

#### 28. Terminal Strength

##### • Pull Force

- One Pound (454 grams), 30 Seconds

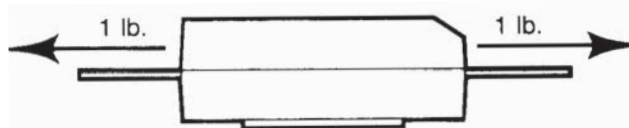

##### • Tensile Force

- Four Pounds (1.8 kilograms), 60 Seconds

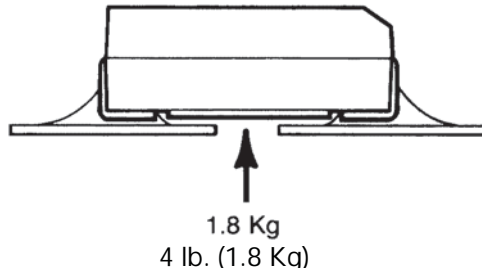

##### • Shear Force

Table 5 Maximum Shear Loads

Case Code		Maximum Shear Loads	
KEMET	EIA	Kilograms	Pounds
B	3528-21	3.6	8.0
V	7343-20	5.0	11.0
D	7343-31	5.0	11.0
X	7343-43	5.0	11.0

Post Test Performance:

- Capacitance — within ±5% of initial value
- DC Leakage — within initial limit
- Dissipation Factor — within initial limit
- ESR - within initial limit

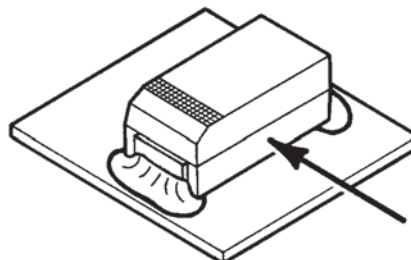

## COMPONENT PERFORMANCE CHARACTERISTICS APPLICATIONS

### 29. Handling

Automatic handling of encapsulated components is enhanced by the molded case which provides compatibility with all types of high speed pick and place equipment. Manual handling of these devices presents no unique problems. Care should be taken with your fingers, however, to avoid touching the solder-coated terminations as body oils, acids and salts will degrade the solderability of these terminations. Finger cots should be used whenever manually handling all solderable surfaces.

### 30. Termination Coating

The standard finish coating is 90/10 Sn/Pb solder (Tin/Lead-solder coated). 100% tin coating is available upon request.

### 31. Recommended Mounting Pad Geometries

Proper mounting pad geometries are essential for successful solder connections. These dimensions are highly process sensitive and should be designed to maximize the integrity of the solder joint, and to minimize component rework due to unacceptable solder joints.

Figure 5 illustrates pad geometry. The table provides recommended pad dimensions for reflow soldering techniques. These dimensions are intended to be a starting point for circuit board designers, to be fine tuned, if necessary, based upon the peculiarities of the soldering process and/or circuit board design.

Contact KEMET for Engineering Bulletin Number F-2100 entitled "Surface Mount Mounting Pad Dimensions and Considerations" for further details on this subject.

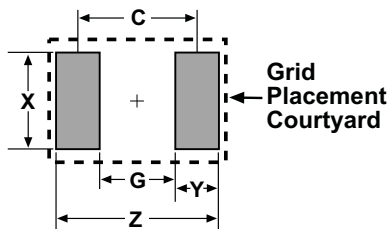

Figure 5

Table 6 - Land Pattern Dimensions for Reflow Solder

KEMET/EIA Size Code	Pad Dimensions				
	Z	G	X	Y (ref)	C (ref)
B/3528-21	5.00	1.10	2.50	1.95	3.05
D/7343-31, V/7343-20, X/7343-43	8.90	3.80	2.70	2.55	6.35

### 32. Soldering

The T520 KO-CAP family has been designed for reflow solder processes. They are not recommended for wave solder. Solder-coated terminations have excellent wetting characteristics for

high integrity solder fillets. Preheating of these components is recommended to avoid extreme thermal stress. The maximum recommended preheat rate is 2°C per second.

Hand-soldering should be avoided. If necessary, it should be performed with care due to the difficulty in process control. Care should be taken to avoid contact of the soldering iron to the molded case. The iron should be used to heat the solder pad, applying solder between the pad and the termination, until reflow occurs. The iron should be removed. "Wiping" the edges of a chip and heating the top surface is not recommended.

During typical reflow operations a slight darkening of the gold-colored epoxy may be observed. This slight darkening is normal and is not harmful to the product. Marking permanency is not affected by this change.

### 33. Washing

Standard washing techniques and solvents are compatible with all KEMET surface mount tantalum capacitors. Solvents such as Freon TMC and TMS, Trichlorethane, methylene chloride, prelete, and isopropyl alcohol are not harmful to these components. Please note that we are not endorsing the use of banned or restricted solvents. We are simply stating that they would not be harmful to the components.

If ultrasonic agitation is utilized in the cleaning process, care should be taken to minimize energy levels and exposure times to avoid damage to the terminations.

KEMET tantalum chips are also compatible with newer aqueous and semi-aqueous processes.

### 34. Encapsulations

Under normal circumstances, potting or encapsulation of KEMET tantalum chips is not required.

### 35. Storage Environment

Tantalum chip capacitors should be stored in normal working environments. While the chips themselves are quite robust in other environments, solderability will be degraded by exposure to high temperatures, high humidity, corrosive atmospheres, and long term storage. In addition, packaging materials will be degraded by high temperature - reels may soften or warp, and tape peel force may increase. KEMET recommends that maximum storage temperature not exceed 40 degrees C, and the maximum storage humidity not exceed 60% relative humidity. In addition, temperature fluctuations should be minimized to avoid condensation on the parts, and atmospheres should be free of chlorine and sulfur bearing compounds. For optimized solderability, chip stock should be used promptly, preferably within 1.5 years of receipt.

### FEATURES

- Polymer Cathode Technology
- Low ESR
- High Frequency Cap Retention
- No-Ignition Failure Mode
- Use Up to 80% of Rated Voltage (20% Derating)
- Capacitance 15 to 1000 $\mu$ F ( $\pm$ 20%)
- Voltage 2V to 25V
- EIA Standard Case Sizes
- 100% Surge Current Tested

### OUTLINE DRAWING

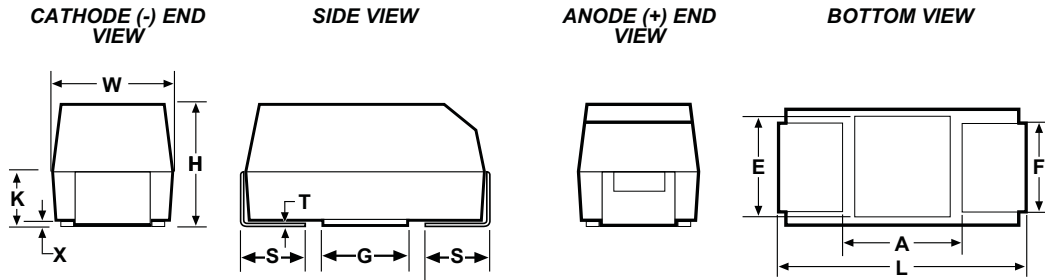

### DIMENSIONS - MILLIMETERS

Case Size		L	W	H	K $\pm$ 0.20	F $\pm$ 0.1	S $\pm$ 0.3	X(Ref)	T(Ref)	A(Min)	G(ref)	E(ref)
KEMET	EIA											
T	3528-12	3.5 $\pm$ 0.2	2.8 $\pm$ 0.2	1.2 max	0.3	2.2	0.8	0.05	0.13	1.1	1.8	2.2
B	3528-21	3.5 $\pm$ 0.2	2.8 $\pm$ 0.2	1.9 $\pm$ 0.2	0.9	2.2	0.8	0.10 $\pm$ 0.10	0.13	1.1	1.8	2.2
V	7343-20	7.3 $\pm$ 0.3	4.3 $\pm$ 0.3	1.9 max	0.9	2.4	1.3	0.05	0.13	3.8	3.5	3.5
D	7343-31	7.3 $\pm$ 0.3	4.3 $\pm$ 0.3	2.8 $\pm$ 0.3	1.5	2.4	1.3	0.10 $\pm$ 0.10	0.13	3.8	3.5	3.5
Y	7343-40	7.3 $\pm$ 0.3	4.3 $\pm$ 0.3	4.0 max	1.9	2.4	1.3	0.10 $\pm$ 0.10	0.13	3.8	3.5	3.5
X	7343-43	7.3 $\pm$ 0.3	4.3 $\pm$ 0.3	4.0 $\pm$ 0.3	2.3	2.4	1.3	0.10 $\pm$ 0.10	0.13	3.8	3.5	3.5

### T520 ORDERING INFORMATION

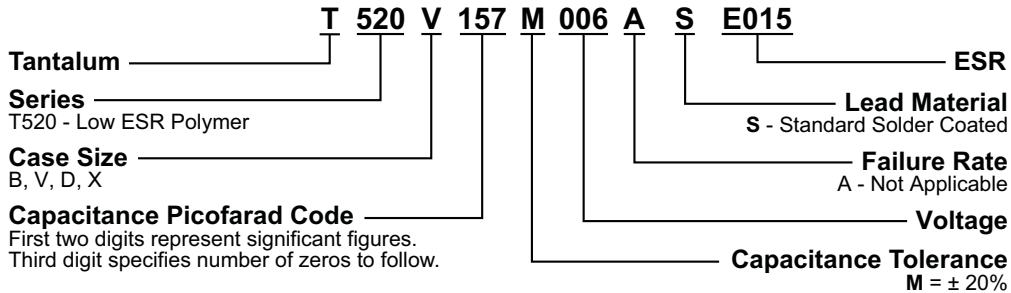

### COMPONENT MARKING

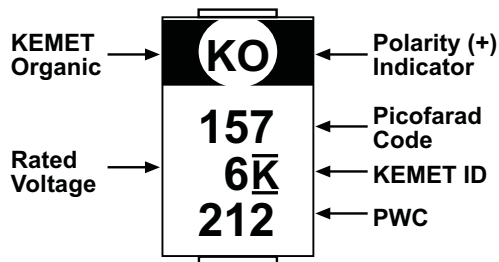

212 = 12th week of 2002

### T520 SERIES CONSTRUCTION

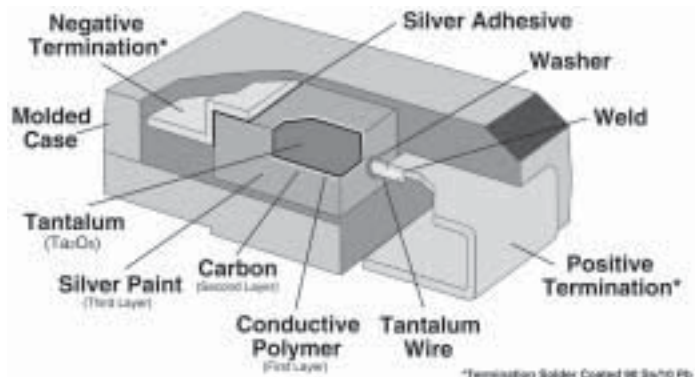

\*Termination Solder Coated 96 Sn/4 Pb



### T520 RATINGS & PART NUMBER REFERENCE

Capacitance $\mu$ F	Case Size	KEMET Part Number	DC Leakage $\mu$ A @ 25°C Max	DF% @ 25°C 120 Hz Max	ESR m $\Omega$ @ 25°C 100 kHz Max	Ripple Current mA rms @ 25°C, 100 kHz Max		
						25°C	85°C	105°C
<b>2 Volt Rating @ +85°C (1.6 Volt Rating at 105°C)</b>								
470.0	V	T520V477M002ASE040	94	10	40	1.8	1.6	0.7
<b>2.5 Volt Rating @ 85°C (2.0 Volt Rating at 105°C)</b>								
100.0	B	T520B107M2R5ASE040	25	8	40	1.5	1.3	0.6
100.0	B	T520B107M2R5ASE070	25	8	70	1.1	1.0	0.4
220.0	V	T520V227M2R5ASE015	55	10	15	2.9	2.6	1.2
220.0	V	T520V227M2R5ASE025	55	10	25	2.2	2.0	0.9
220.0	V	T520V227M2R5ASE045	55	10	45	1.7	1.5	0.7
330.0	V	T520V337M2R5ASE009	99	10	9	3.7	3.4	1.5
330.0	V	T520V337M2R5ASE015	83	10	15	2.9	2.6	1.2
330.0	V	T520V337M2R5ASE025	83	10	25	2.2	2.0	0.9
470.0	V	T520V477M2R5ASE012	118	10	12	3.2	2.9	1.3
470.0	V	T520V477M2R5ASE015	118	10	15	2.9	2.6	1.2
680.0	D	T520D687M2R5ASE015	170	10	15	3.2	2.8	1.3
680.0	D	T520D687M2R5ASE040	170	10	40	1.9	1.7	0.8
680.0	Y	T520Y687M2R5ATE025	170	10	25	2.5	2.3	1.0
1000.0	Y	T520Y108M2R5ATE025	250	10	25	2.5	2.3	1.0
<b>3 Volt Rating at 85°C (2.4 Volt Rating at 105°C)</b>								
100.0	B	T520B107M003ASE040	30	8	40	1.5	1.3	0.6
100.0	B	T520B107M003ASE070	30	8	70	1.1	1.0	0.4
150.0	B	T520B157M003ASE040	45	8	40	1.5	1.3	0.6
150.0	B	T520B157M003ASE070	45	8	70	1.1	1.0	0.4
330.0	V	T520V337M003ASE012	99	10	12	3.2	2.9	1.3
330.0	V	T520V337M003ASE015	99	10	15	2.9	2.6	1.2
330.0	V	T520V337M003ASE025	99	10	25	2.2	2.0	0.9
680.0	D	T520D687M003ASE015	204	10	15	3.2	2.8	1.3
680.0	D	T520D687M003ASE040	204	10	40	1.9	1.7	0.8
1000.0	X	T520X108M003ASE015	300	10	15	3.3	3.0	1.3
1000.0	X	T520X108M003ASE030	300	10	30	2.3	2.1	0.9
<b>4 Volt Rating @ +85°C (3.3 Volt Rating at +105°C)</b>								
15.0	T	T520T156M004ASE100	6	8	100	0.8	0.7	0.3
68.0	B	T520B686M004ASE040	27	8	40	1.5	1.3	0.6
68.0	B	T520B686M004ASE070	27	8	70	1.1	1.0	0.4
100.0	B	T520B107M004ASE040	40	8	40	1.5	1.3	0.6
100.0	B	T520B107M004ASE070	40	8	70	1.1	1.0	0.4
150.0	B	T520B157M004ASE040	60	8	40	1.5	1.3	0.6
150.0	B	T520B157M004ASE070	60	8	70	1.1	1.0	0.4
150.0	V	T520V157M004ASE015	60	10	15	2.9	2.6	1.2
150.0	V	T520V157M004ASE025	60	10	25	2.2	2.0	0.9
220.0	V	T520V227M004ASE015	88	10	15	2.9	2.6	1.2
220.0	V	T520V227M004ASE025	88	10	25	2.2	2.0	0.9
220.0	V	T520V227M004ASE045	88	10	45	1.7	1.5	0.7
220.0	D	T520D227M004ASE065	88	10	65	1.5	1.4	0.6
330.0	V	T520V337M004ASE025	132	10	25	2.2	2.0	0.9
330.0	V	T520V337M004ASE040	132	10	40	1.8	1.6	0.7
330.0	D	T520D337M004ASE015	132	10	15	3.2	2.8	1.3
330.0	D	T520D337M004ASE040	132	10	40	1.9	1.7	0.8
330.0	D	T520D337M004ASE045	132	10	45	1.8	1.6	0.7
470.0	D	T520D477M004ASE012	188	10	12	3.5	3.2	1.4
470.0	D	T520D477M004ASE015	188	10	15	3.2	2.8	1.3
470.0	D	T520D477M004ASE018	188	10	18	2.9	2.6	1.2
470.0	D	T520D477M004ASE025	188	10	25	2.4	2.2	1.0
470.0	D	T520D477M004ASE040	188	10	40	1.9	1.7	0.8
680.0	Y	T520Y687M004ATE025	272	10	25	2.5	2.3	1.0
680.0	X	T520X687M004ASE015	272	10	15	3.3	3.0	1.3
680.0	X	T520X687M004ASE035	272	10	35	2.2	2.0	0.9
<b>6/6.3 Volt Rating @ +85°C (5 Volt Rating at +105°C)</b>								
15.0	T	T520T156M006ASE100	9.5	8	100	0.8	0.7	0.3
33.0	B	T520B336M006ASE040	21	8	40	1.5	1.3	0.6
33.0	B	T520B336M006ASE070	21	8	70	1.1	1.0	0.4
33.0	T	T520T336M006ATE070	21	8	70	1	0.9	0.4
47.0	B	T520B476M006ASE040	30	8	40	1.5	1.3	0.6
47.0	B	T520B476M006ASE070	30	8	70	1.1	1.0	0.4
68.0	B	T520B686M006ASE040	43	8	40	1.5	1.3	0.6
68.0	B	T520B686M006ASE070	43	8	70	1.1	1.0	0.4
100.0	B	T520B107M006ASE040	63	8	40	1.5	1.3	0.6
100.0	B	T520B107M006ASE070	63	8	70	1.1	1.0	0.4
150.0	V	T520V157M006ASE015	95	10	15	2.9	2.6	1.2
150.0	V	T520V157M006ASE025	95	10	25	2.2	2.0	0.9
150.0	V	T520V157M006ASE040	95	10	40	1.8	1.6	0.7
150.0	V	T520V157M006ASE045	95	10	45	1.7	1.5	0.7
150.0	D	T520D157M006ASE015	95	10	15	3.2	2.8	1.3
150.0	D	T520D157M006ASE025	95	10	25	2.4	2.2	1.0
150.0	D	T520D157M006ASE055	95	10	55	1.7	1.5	0.7
220.0	V	T520V227M006ASE015	139	10	15	2.9	2.6	1.2
220.0	V	T520V227M006ASE025	139	10	25	2.2	2.0	0.9
220.0	V	T520V227M006ASE040	139	10	40	1.8	1.6	0.7
220.0	D	T520D227M006ASE015	139	10	15	3.2	2.8	1.3
220.0	D	T520D227M006ASE040	139	10	40	1.9	1.7	0.8
220.0	D	T520D227M006ASE050	139	10	50	1.7	1.6	0.7
330.0	V	T520V337M006ASE025	208	10	25	2.2	2.0	0.9
330.0	V	T520V337M006ASE040	208	10	40	1.8	1.6	0.7
330.0	D	T520D337M006ASE015	208	10	15	3.2	2.8	1.3
330.0	D	T520D337M006ASE025	208	10	25	2.4	2.2	1.0
330.0	D	T520D337M006ASE040	208	10	40	1.9	1.7	0.8
330.0	D	T520D337M006ASE045	208	10	45	1.8	1.6	0.7
330.0	Y	T520Y337M006ATE025	208	10	25	2.5	2.3	1.0
470.0	Y	T520Y477M006ATE025	296	10	25	2.5	2.3	1.0
470.0	X	T520X477M006ASE018	296	10	18	3.0	2.7	1.2
470.0	X	T520X477M006ASE035	296	10	35	2.2	2.0	0.9
470.0	X	T520X477M006ASE040	296	10	40	2.0	1.8	0.8

## T520 RATINGS & PART NUMBER REFERENCE

Capacitance $\mu\text{F}$	Case Size	KEMET Part Number	DC Leakage $\mu\text{A}$ @ 25°C Max	DF% @ 25°C 120 Hz Max	ESR $\text{m}\Omega$ @ 25°C 100 kHz Max	Ripple Current A rms @ 25°C, 100 kHz Max		
<b>8 Volt Rating @ +85°C (6.4 Volt Rating at +105°C)</b>								
33.0	B	T520B336M008ASE040	26	8	40	1.5	1.3	0.6
33.0	B	T520B336M008ASE070	27	8	70	1.1	1.0	0.4
150.0	D	T520D157M008ASE025	120	10	25	2.4	2.2	1.0
150.0	D	T520D157M008ASE040	120	10	40	1.9	1.7	0.8
150.0	D	T520D157M008ASE055	120	10	55	1.7	1.5	0.7
<b>10 Volt Rating @ +85°C (8 Volt Rating at +105°C)</b>								
33.0	B	T520B336M010ASE040	33	8	40	1.5	1.3	0.6
33.0	B	T520B336M010ASE070	33	8	70	1.1	1.0	0.4
68.0	V	T520V686M010ASE045	68	10	45	1.7	1.5	0.7
68.0	V	T520V686M010ASE060	68	10	60	1.4	1.3	0.6
100.0	V	T520V107M010ASE018	100	10	18	2.6	2.4	1.1
100.0	V	T520V107M010ASE025	100	10	25	2.2	2.0	0.9
100.0	V	T520V107M010ASE045	100	10	45	1.7	1.5	0.7
100.0	V	T520V107M010ASE050	100	10	50	1.6	1.4	0.6
100.0	D	T520D107M010ASE018	100	10	18	3.2	2.8	1.3
100.0	D	T520D107M010ASE055	100	10	55	1.7	1.5	0.7
100.0	D	T520D107M010ASE080	100	10	80	1.4	1.2	0.5
150.0	D	T520D157M010ASE025	150	10	25	2.4	2.2	1.0
150.0	D	T520D157M010ASE040	150	10	40	1.9	1.7	0.8
150.0	D	T520D157M010ASE055	150	10	55	1.7	1.5	0.7
220.0	D	T520D227M010ASE018	220	10	18	2.9	2.6	1.2
220.0	D	T520D227M010ASE025	220	10	25	2.4	2.2	1.0
220.0	D	T520D227M010ASE040	220	10	40	1.9	1.7	0.8
330.0	X	T520X337M010ASE025	330	10	25	2.6	2.3	1.0
330.0	X	T520X337M010ASE040	330	10	40	2.0	1.8	0.8
<b>16 Volt Rating @ +85°C (12.8 Volt Rating at +105°C)</b>								
33.0	V	T520V336M016ASE060	53	10	60	1.4	1.3	0.6
47.0	V	T520V476M016ASE070	76	10	70	1.3	1.2	0.5
47.0	D	T520D476M016ASE070	75	10	70	1.5	1.3	0.6
<b>25 Volt Rating @ +85°C (20 Volt Rating at +105°C)</b>								
15.0	D	T520D156M025ASE080	38	10	80	1.4	1.2	0.5

Newest values indicated in RED

Polymer Tantalum Surface Mount

## TYPICAL FREQUENCY RESPONSE CURVES

