

阅读申明

- 1.本站收集的数据手册和产品资料都来自互联网，版权归原作者所有。如读者和版权方有任何异议请及时告之，我们将妥善解决。
- 2.本站提供的中文数据手册是英文数据手册的中文翻译，其目的是协助用户阅读，该译文无法自动跟随原稿更新，同时也可能存在翻译上的不当。建议读者以英文原稿为参考以便获得更精准的信息。
- 3.本站提供的产品资料，来自厂商的技术支持或者使用者的心得体会等，其内容可能存在描述上的差异，建议读者做出适当判断。
- 4.如需与我们联系，请发邮件到marketing@iczoom.com，主题请标有“数据手册”字样。

Read Statement

1. The datasheets and other product information on the site are all from network reference or other public materials, and the copyright belongs to the original author and original published source. If readers and copyright owners have any objections, please contact us and we will deal with it in a timely manner.
2. The Chinese datasheets provided on the website is a Chinese translation of the English datasheets. Its purpose is for reader's learning exchange only and do not involve commercial purposes. The translation cannot be automatically updated with the original manuscript, and there may also be improper translations. Readers are advised to use the English manuscript as a reference for more accurate information.
3. All product information provided on the website refer to solutions from manufacturers' technical support or users the contents may have differences in description, and readers are advised to take the original article as the standard.
4. If you have any questions, please contact us at marketing@iczoom.com and mark the subject with "Datasheets" .

MULTI-CON-X® FIELD INSTALLABLE CONNECTORS



Cable Pin
3X8X-XPB-XXX
Matching Mates:

- Cable-Cable
5X8X-XSG-XXX
- Panel
4XXX-XSG-XXX



Panel Mount
4X8X-XXG-XXX
Matching Mates:

- Cable Pin
3X8X-XPB-XXX
- Cable Socket
3X8X-XSG-XXX



P/C Tail Panel Mount
4XXX-XXG-XXX
Matching Mates:

- Cable Pin
3X8X-XPB-XXX
- Cable Socket
3X8X-XSG-XXX



Cable Socket
3X8X-XSG-XXX
Matching Mates:

- Cable-Cable
5X8X-XPB-XXX
- Panel
4XXX-XPB-XXX



Cable to Cable
5X8X-XXG-XXX
Matching Mates:

- Cable Pin
3X8X-XPB-XXX
- Cable Socket
3X8X-XSG-XXX



Mechanical Back Shell
(Style #5)



Square Flange Adapter
4296

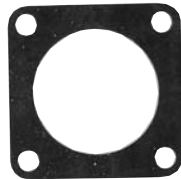

Square Flange Gasket
4297



Dust Cap
4295



Winged Coupling Ring
W/4482

Molded Cable Assemblies (See pages 3 & 26)



Cable End



Cable to Cable



Right Angle

MULTI-CON-X[®] FIELD INSTALLABLE CONNECTORS

Dimensions

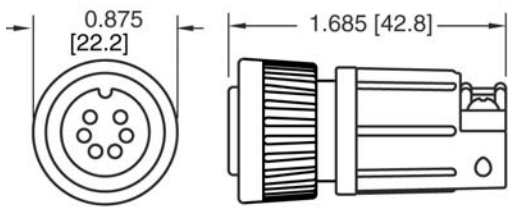

CABLE END CONNECTOR
STYLE 5 LONG
THREADED BACKSHELL

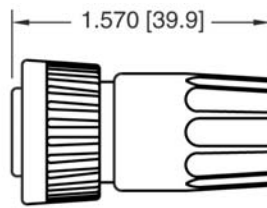

CABLE END CONNECTOR (SOLDER)
STYLE 3 AND 3DC LONG
THREADED BACKSHELL
(SOLDER TYPE CONTACT ONLY)

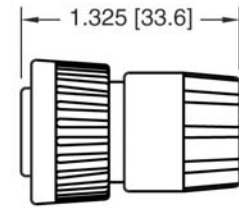

CABLE END CONNECTOR (CRIMP)
STYLE 3 AND 3DC SHORT
THREADED BACKSHELL
(CRIMP TYPE CONTACT ONLY)

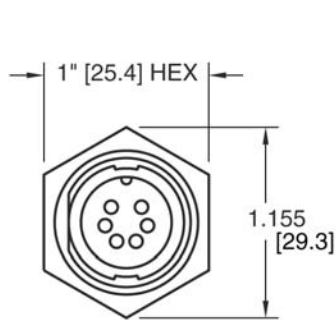

13/16" [20.6]-27 UNS MOD. THREAD
1/32" TO 3/16" PANEL
[0.8 TO 4.8]

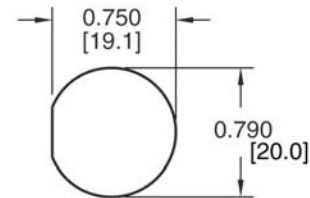
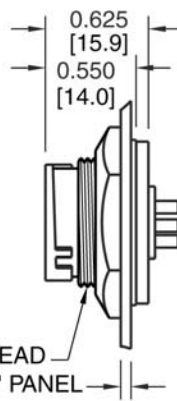

RECOMMENDED
PANEL CUT-OUT
±.003 [±0.1]

PANEL MOUNT CONNECTOR
SHOWN WITH HEX NUT AND GASKET

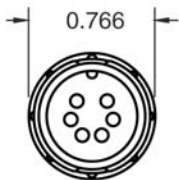

CABLE TO CABLE CONNECTOR
STYLE 5 LONG THREADED BACKSHELL

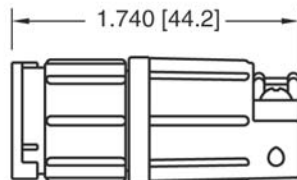

CABLE TO CABLE CONNECTOR
STYLE 3 AND 3DC LONG
THREADED BACKSHELL
(SOLDER TYPE CONTACT ONLY)

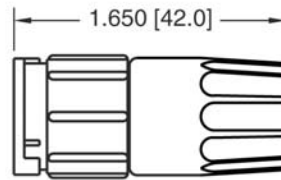

CABLE TO CABLE CONNECTOR
STYLE 3 AND 3DC SHORT
THREADED BACKSHELL
(CRIMP TYPE CONTACT ONLY)

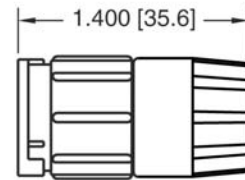

Molded Cable Assemblies (See pages 3 & 26)

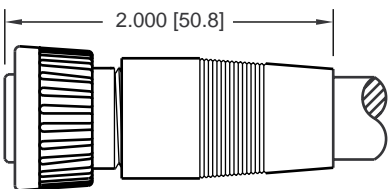

CABLE END ASSEMBLY
STRAIGHT BOOT 0.500 [12.7] MAX. CABLE O.D.

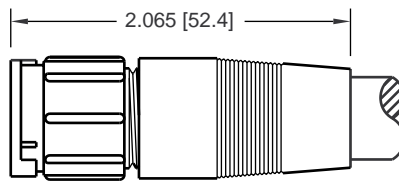

CABLE TO CABLE ASSEMBLY
STRAIGHT BOOT 0.500 [12.7] MAX. CABLE O.D.

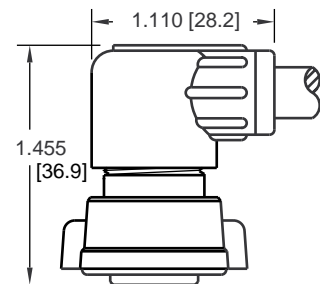

CABLE END ASSEMBLY
90° BOOT 0.365 [9.3] MAX. CABLE O.D.

MULTI-CON-X® FIELD INSTALLABLE CONNECTORS

Part Number to Order

X X XX-X XG-XXX

Connector Type: _____

- 3 - Cable End
- 4 - Panel Mount
- 5 - Cable to Cable

Contact Size: _____

- 1 - #12 (2-4 Contacts)
- 2 - #20 (4-9 Contacts)
- 3 - #16 (4-6 Contacts)

Contact Style: _____

- 80 - Crimp (Supplied loose)
- 81 - P/C Tail .187" (4.7) (Supplied assembled)
- 82 - Solder Cup (Supplied assembled)
- 91 - P/C Tail .280" (7.1) (Supplied assembled)*
- 92 - P/C Tail .335" (8.5) (Supplied assembled)*

Number of Contacts: _____

- 2, 3, 4, 5, 6, 7, 8 & 9

Type of Contact: _____

- P - Pin
- S - Socket

Contact Plating: _____

- G - Gold over Nickel (Standard)

EMI/RFI shielded assemblies available - consult factory.

*Available in #20 size contact only.

Consult factory for optional threaded coupling.

Consult factory for your custom design cable assemblies and connectors. (See pages 3 & 26)

Grommet Code -

Cable O.D. Range:

- 15 - .15 - .17 (3.8-4.3)
- 18 - .18 - .20 (4.6-5.1)
- 21 - .21 - .23 (5.3-5.8)
- 24 - .24 - .27 (6.1-6.8)
- 28 - .24 - .28 (7.1-7.4)
- 30 - .30 - .32 (7.6-8.1)

Back Shell
Style
3 or 5

Back Shell Style:

- 3 - Weathertight grommet grip/seal & (1) interfacial "O" ring.
- 3DC - Daisy chain grommet with 3 I.D.s (.125, .188 & .250)
- 5 - Mechanical screw-down cable clamp with grommet seal.
- 300 - Panel mount with hex nut & gasket.
- 3ES - 300 with Epoxy (Panel Mount Only)

Contact Arrangements

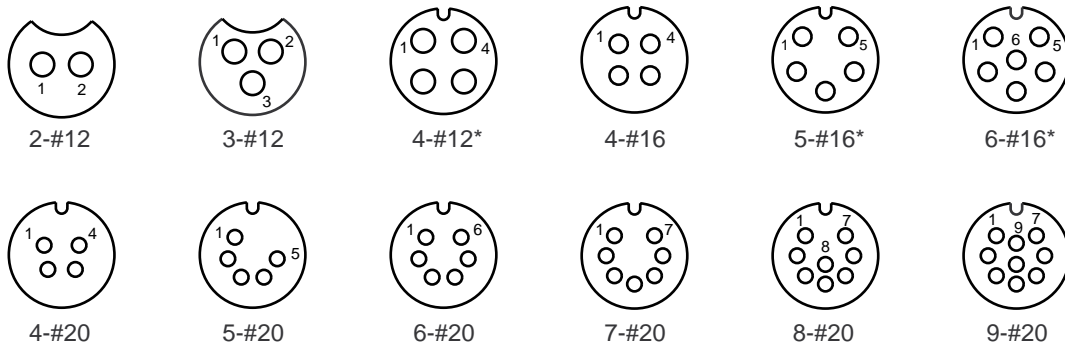

Contact arrangements shown are wiring view of cable end pins/sockets.

Key/keyway shown for orientation only.

*Available in connector types: cable end socket, panel mount pin, and cable to cable pin styles only.

MULTI-CON-X[®] FIELD INSTALLABLE CONNECTORS

Specifications

Typical Specifications

Manufacturers Identifications	Multi-Con-X [®]
Description	Field Installable Connector & Custom Cable Assemblies
Rating	1.95 thru 23.0A, 600V
Conductor Size	#12 Contacts, 12 thru 14 AWG #16 Contacts, 16 thru 18 AWG #20 Contacts, 20 thru 24 AWG
Configuration	2 thru 4 #12 Contacts 4 thru 6 #16 Contacts 4 thru 9 #20 Contacts
Certification	UL Recognized File #E138878 - 250V CSA Certified File #LR89277 - 600V

Material Specifications

Cable Pin/Socket

Backshell (Threaded)	Nylon, UL Recognized, Black (Style #3)
Grommet	Santoprene Rubber, Black
Coupling Ring	Nylon, UL Recognized, Black
Contacts	Brass, Gold over Nickel
Connector Body	Nylon, UL Recognized, Black
O-Ring	Nitrile Rubber, Black
Sleeve	Nylon, UL Recognized, Black

Cable to Cable

Backshell (Threaded)	Nylon, UL Recognized, Black (Style #3)
Grommet	Santoprene, Rubber, Black
Contacts	Brass, Gold over Nickel
Connector Body	Nylon, UL Recognized, Black

Optional

Long Backshell (Threaded)	Nylon, UL Recognized, Black (Style #3 with solder contacts)
Winged Coupling Ring	Nylon, UL Recognized, Black (W/4482)
Mechanical Backshell (Threaded)	Nylon, UL Recognized, Black (Style #5)
- Strap	Nylon, UL Recognized, Black
- Screws	Cadmium Plated

Panel Mount

Contacts	Brass, Gold over Nickel
Panel Body	Nylon, UL Recognized, Black
Gasket	Nitrile Rubber, Black
Hex Nut	Nylon, UL Recognized, Black

Optional

Dust Cap	Santoprene Rubber, Black (Part No. 4295)
Square Flange Adapter	Nylon, UL Recognized, Black (Part No. 4296)
Square Flange Adapter Gasket	Nitrile Rubber, Black (Part No. 4297)

Mechanical Specifications

Durability	Minimum 300 mate/unmate cycles without mechanical or electrical failure
Vibration	Coupling rings have overriding locking feature to prevent loosening or separation of connector
Hex Nut Torque	All series hex nut to withstand 10-12 inch/lb tightening torque

Electrical Specifications

Voltage	600 V
Current	See Electrical Current Rating Chart (Page 27)

Environmental Specifications

Temperature Rating	-55°C to +125°C (-67°F to +257°F)
Corrosion	300 Hr salt spray contacts
Weatheright	Consult factory with specific application

Molded Cable Assemblies

Watertight	(See Pages 3 & 26) NEMA 6P, 13: IEC IP67
------------	---