

阅读申明

- 1.本站收集的数据手册和产品资料都来自互联网，版权归原作者所有。如读者和版权方有任何异议请及时告之，我们将妥善解决。
- 2.本站提供的中文数据手册是英文数据手册的中文翻译，其目的是协助用户阅读，该译文无法自动跟随原稿更新，同时也可能存在翻译上的不当。建议读者以英文原稿为参考以便获得更精准的信息。
- 3.本站提供的产品资料，来自厂商的技术支持或者使用者的心得体会等，其内容可能存在描述上的差异，建议读者做出适当判断。
- 4.如需与我们联系，请发邮件到marketing@iczoom.com，主题请标有“数据手册”字样。

Read Statement

1. The datasheets and other product information on the site are all from network reference or other public materials, and the copyright belongs to the original author and original published source. If readers and copyright owners have any objections, please contact us and we will deal with it in a timely manner.
2. The Chinese datasheets provided on the website is a Chinese translation of the English datasheets. Its purpose is for reader's learning exchange only and do not involve commercial purposes. The translation cannot be automatically updated with the original manuscript, and there may also be improper translations. Readers are advised to use the English manuscript as a reference for more accurate information.
3. All product information provided on the website refer to solutions from manufacturers' technical support or users the contents may have differences in description, and readers are advised to take the original article as the standard.
4. If you have any questions, please contact us at marketing@iczoom.com and mark the subject with "Datasheets" .



DEUTSCH

BRANCHE CONNECTEURS AEROMILITAIRES



DTS series Normes MIL-C 38999 Series III

1 - 2	Introduction <i>Présentation</i>
3	Synoptic <i>Synoptique</i>
4 - 5	Technical characteristics <i>Caractéristiques techniques</i>
6 - 7	Part-numbering system <i>Système de référence</i>
8	Key orientation <i>Détrompage mécanique</i>
9	Arrangements <i>Arrangements</i>
10	Receptacles <i>Embases</i>
11	Hermetic receptacles <i>Embases hermétiques</i>
12	Hermetic receptacles and Plug <i>Embases hermétiques et Fiche</i>
13	Break adapter and Panel seal <i>Prise de repos et Joints plats</i>
14-15	Contacts and Tools <i>Contacts et Outillages</i>
16	Mating and unmating dimensions <i>Accouplements</i>
17	Mounting style <i>Modes de fixation</i>

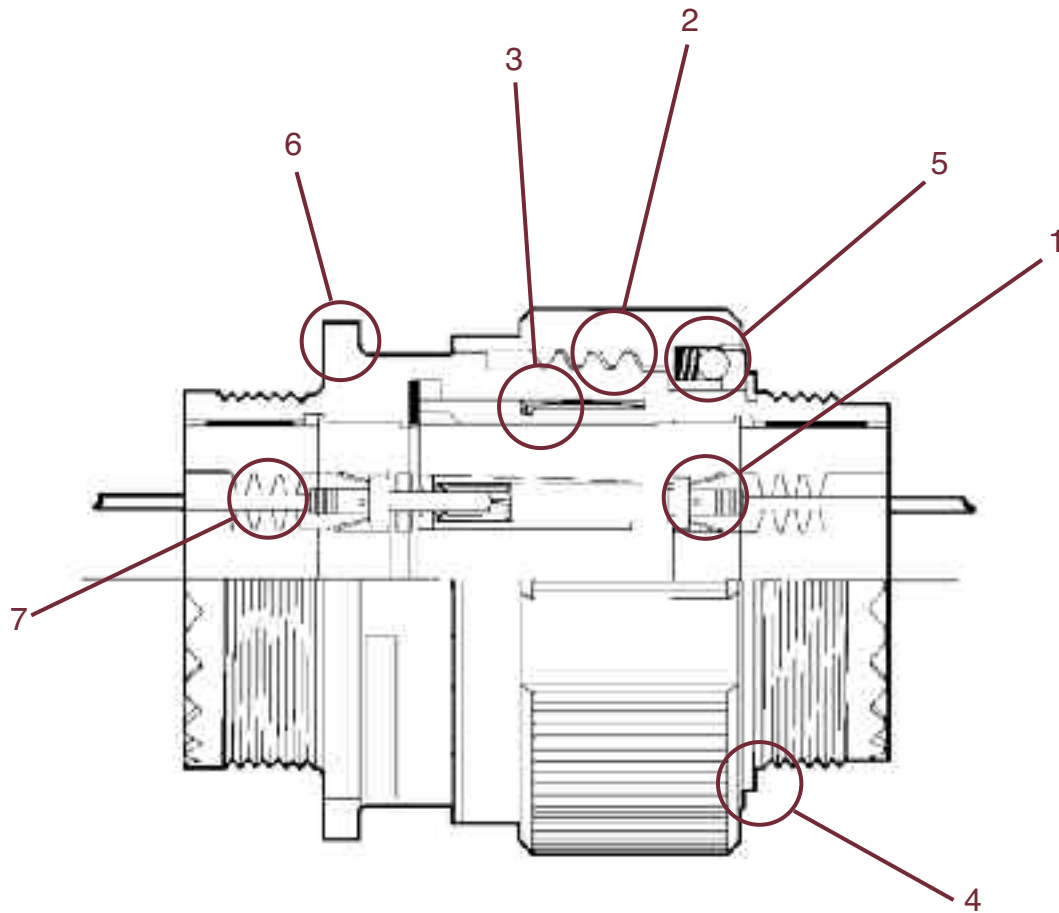

- 1 - Deutsch proven dielectric retention system provides superior contact retention under severe vibration.
- 2 - The DTS series provides 100 % metal to metal bottoming for maximum EMI grounding protection.
- 3 - Grounding fingers provide excellent EMI protection.
- 4 - Non-reflective olive drab cadmium over nickel shell plating provides 500 hours salt spray corrosion protection.
- 5 - Threaded coupling with self locking.
- 6 - Elongated mounting holes permit the DTS connector to intermount with existing standard MIL-C 38999 box or wall mount receptacles, giving it a design replacement advantage.
- 7 - Cie Deutsch uses superior silicone seals providing maximum tear resistance and sealing memory.

- 1 - Clips moulés d'une seule pièce dans le bloc isolant réalisé en résine thermoplastique.
- 2 - Filetage trapézoïdale assurant une meilleure continuité électrique entre boîtiers.
- 3 - Continuité électrique entre fiche et embase, par couronne de masse (R.F.I.).
- 4 - Protection spéciale cadmié vert olive 500 heures brouillard salin.
- 5 - Verrouillage à vis auto-freinée à sens prépondérant au verrouillage.
- 6 - Colletette carrée avec 4 trous oblongs, permettant un montage en lieu et place des connecteurs existants, suivant MIL-C 38999.
- 7 - Elastomère de silicone et résine composite à haute résistance aux fluides.

- Threaded coupling with self locking.
- 100 % scoop-proof shells.
- High resistance mechanical aluminium shells.
- Stainless steel shells for hermetic version.
- Corrosion : 500 hours salt spray protection for class W.
- R.F.I. fingers.
- Plugs and receptacles are equipped with thermoplastic and elastomer insert.
- Thermoplastic clips molded directly with insert.
- Hermetic receptacle shells with glass insert.
- Removable crimping contacts (MIL-C 39029).
- Sealing receptacle with contacts for printed circuit.
- Hermetic receptacle with solder contacts, contacts for printed circuit.
- Connector in accordance with specifications MIL-C 38999 series III.
- Connector QPL (to order as per QPL).
- *Verrouillage rapide à vis 3 filets.*
- *Boîtier 100 % scoop-proof.*
- *Boîtier en alliage d'aluminium à haute résistance mécanique.*
- *Boîtier en inox pour les hermétiques.*
- *Protection 500 heures au brouillard salin en finition W pour la version étanche.*
- *Fiches avec couronne de masse R.F.I.*
- *Fiches et embases étanches avec isolant en résine et élastomère de synthèse.*
- *Clips thermoplastiques de rétention des contacts, moulés dans l'isolant central.*
- *Embases hermétiques à scellement verre métal.*
- *Contacts à sertir démontables (MIL-C 39029).*
- *Contacts à picots pour connecteur étanche.*
- *Contacts à souder et à picot pour embases hermétiques non démontables.*
- *Les connecteurs DTS répondent aux normes MIL-C 38999 série III.*
- *Connecteur QPL (commander suivant QPL)*

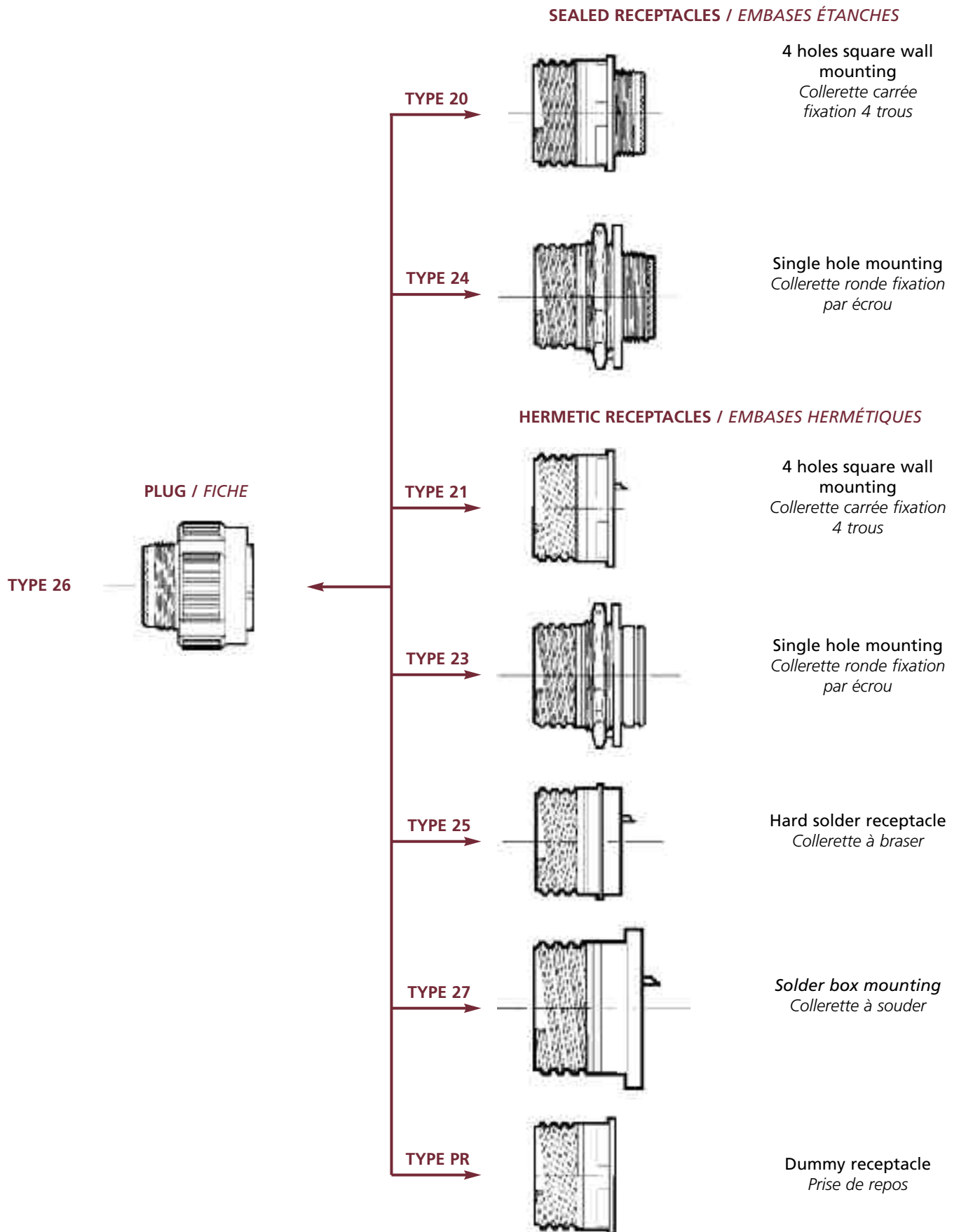

■ Mechanical

Shell	Material	Sealed version	: Aluminium alloy
		Hermetic version	: Stainless steel
	Plating	Sealed version	: W- Olive drab cadmium F - Nickel
		Hermetic version	: Y - Passived N - Nickel
RFI ring	Material		: Beryllium copper
	Plating		: Nickel/cadmium
Insert	Material	Sealed version	: Thermoplastic and fluorinated silicone elastomer
		Hermetic version	: Sintered glass insert
Flat gasket and 'o'ring	Material		: Fluoronited silicone elastomer
Contact	Material	Sealed version	: Copper alloy
		Hermetic version	: Ferrous and nickel
	Plating		: Gold
		Sealed version	: Crimp type or printed circuit pin (consult us)
	Type	Hermetic version	: Solder type or printed circuit pin (consult us)
Retention			: Size 22 D : 4,5 N Size 12 : 11,1 N Size 20 : 6,7 N Size 8 : 11,1 N Size 16 : 11,1 N
Vibrations			: As per MIL-C 38999
Physical shocks			: 300 g, 3 ms in the 3 axes
Durability			: 500 coupling and uncoupling cycles

■ Climatics

Service temperature	Sealed version	: Cadmium plating - 65° C to + 175° C Nickel plating - 65° C to + 200° C
	Hermetic version	: Passived plating - 65° C to + 200° C
Thermal shocks		: As per MIL-C 38999
Sealing		: Leakage ≤ 16 cm ³ /h on mated connecting under 2.1 bars
Salt spray resistance	Sealed version	: 500 hours class W, as per MIL-C 38999 48 hours class F, N and Y, as per MIL-C 38999

■ Electrical

Withstanding voltage	at sea level	: Service M : 1300 V Service I : 1800 V Service II : 2300 V
	at 21000 m altitude	: Mated connector Unmated connector Service M : 800 V Service M : 350 V Service I : 1000 V Service I : 400 V Service II : 1000 V Service II : 500 V
Insulation resistance		: ≥ 5000 MΩ to 25° C and 65 % HR max.
Voltage drop		: Size 22 : test to 5 Amp. = 73 millivolts max. Size 20 : test to 7,5 Amp. = 55 millivolts max. Size 16 : test to 13 Amp. = 49 millivolts max. Size 12 : test to 23 Amp. = 42 millivolts max. Size 8 : test to 46 Amp. = 26 millivolts max.
Shielding		: As per MIL-C 38999

Size	Contacts current		Diameter over insulation sheath in mm	Permitted wire sizes Section in mm ²
	Sealing version	Hermetic version		
22	5 A	3 A	0,76 to 1,37	0,095 to 0,38
20	7,5 A	5 A	1,01 to 2,10	0,21 to 0,60
16	13 A	10 A	1,65 to 2,77	0,60 to 1,34
12	23 A	17 A	2,46 to 3,61	1,91 to 3,18
8	46 A	40 A	4,50 to 5,80	5,30 to 8,98

For more information, see MIL-C 38999 series III

■ Mécaniques

Boîtier	Matière	Version étanche	: Alliage d'aluminium
		Version hermétique	: Acier inoxydable
	Revêtement	Version étanche	: W : Cadmié vert olive, F : Nickelé
		Version hermétique	: Y : Passivé, N : Nickelé
Couronne de masse RFI			
	Matière		: Cuivre au béryllium
	Revêtement		: Nickelé / cadmié
Isolant	Matière	Version étanche	: Thermoplastique et élastomère de silicone fluoré
		Version hermétique	: Verre fritté monobloc
Joint périphérique et torique			
	Matière		: Elastomère de silicone fluoré
Contact	Matière	Version étanche	: Alliage de cuivre
		Version hermétique	: Ferro-nickel
	Revêtement		: Or
	Type	Version étanche	: A sertir ou à picot (nous consulter)
		Version hermétique	: A souder ou à picot (nous consulter)
Rétention mécanique des contacts dans l'isolant		Taille 22	: 4,5 daN
		Taille 12	: 11,1 daN
		Taille 20	: 6,7 daN
		Taille 8	: 11,1 daN
		Taille 16	: 11,1 daN
Vibrations			: Suivant MIL-C 38999
Chocs			: 300 g, 3 ms dans les 3 axes
Endurance mécanique			: 500 cycles accouplement / désaccouplement

■ Climatiques

Température d'utilisation	Version étanche	: Revêtement cadmié - 65° C à + 175° C
		: Revêtement nickelé - 65° C à + 200° C
	Version hermétique	: Revêtement passivé - 65° C à + 200° C
Chocs thermiques		: Suivant MIL-C 38999
Etanchéité		: Fuite ≤ 16 cm ³ /h sur connecteur accouplé sous 2.1 bars
Tenue au brouillard salin	Version étanche	: 500 heures classe W, suivant MIL-C 38999,
		: 48 heures classe F, N et Y, suivant MIL-C 38999

■ Electriques

Tension de tenue	au niveau de la mer	Service M	: 1300 V eff.
		Service I	: 1800 V eff.
		Service II	: 2300 V eff.
	à 21000 mètres d'altitude	Connecteur accouplé	: Connecteur désaccouplé
		Service M : 800 V eff.	Service M : 350 V eff.
		Service I : 1000 V eff.	Service I : 400 V eff.
		Service II : 1000 V eff.	Service II : 500 V eff.
Résistance d'isolement			: ≥ 5000 MΩ à 25° C et 60% HR max.
Chute de tension		Taille 22	: test à 5 Amp. = 73 millivolts max.
		Taille 20	: test à 7,5 Amp. = 55 millivolts max.
		Taille 16	: test à 13 Amp. = 49 millivolts max.
		Taille 12	: test à 23 Amp. = 42 millivolts max.
		Taille 8	: test à 46 Amp. = 26 millivolts max.
Blindage			: Suivant MIL-C 38999

Taille	Intensité max. des contacts		Ø sur gaine en mm	Câble utilisable Section en mm ²
	Version étanche	Version hermétique		
22	5 A	3 A	0,76 à 1,37	0,095 à 0,38
20	7,5 A	5 A	1,01 à 2,10	0,21 à 0,60
16	13 A	10 A	1,65 à 2,77	0,60 à 1,34
12	23 A	17 A	2,46 à 3,61	1,91 à 3,18
8	46 A	40 A	4,50 à 5,80	5,30 à 8,98

Pour plus d'informations techniques, se reporter à la norme MIL-C 38999 série III.

DEUTSCH SYSTEM - SEALED VERSION
SYSTEME DEUTSCH - VERSION ETANCHE

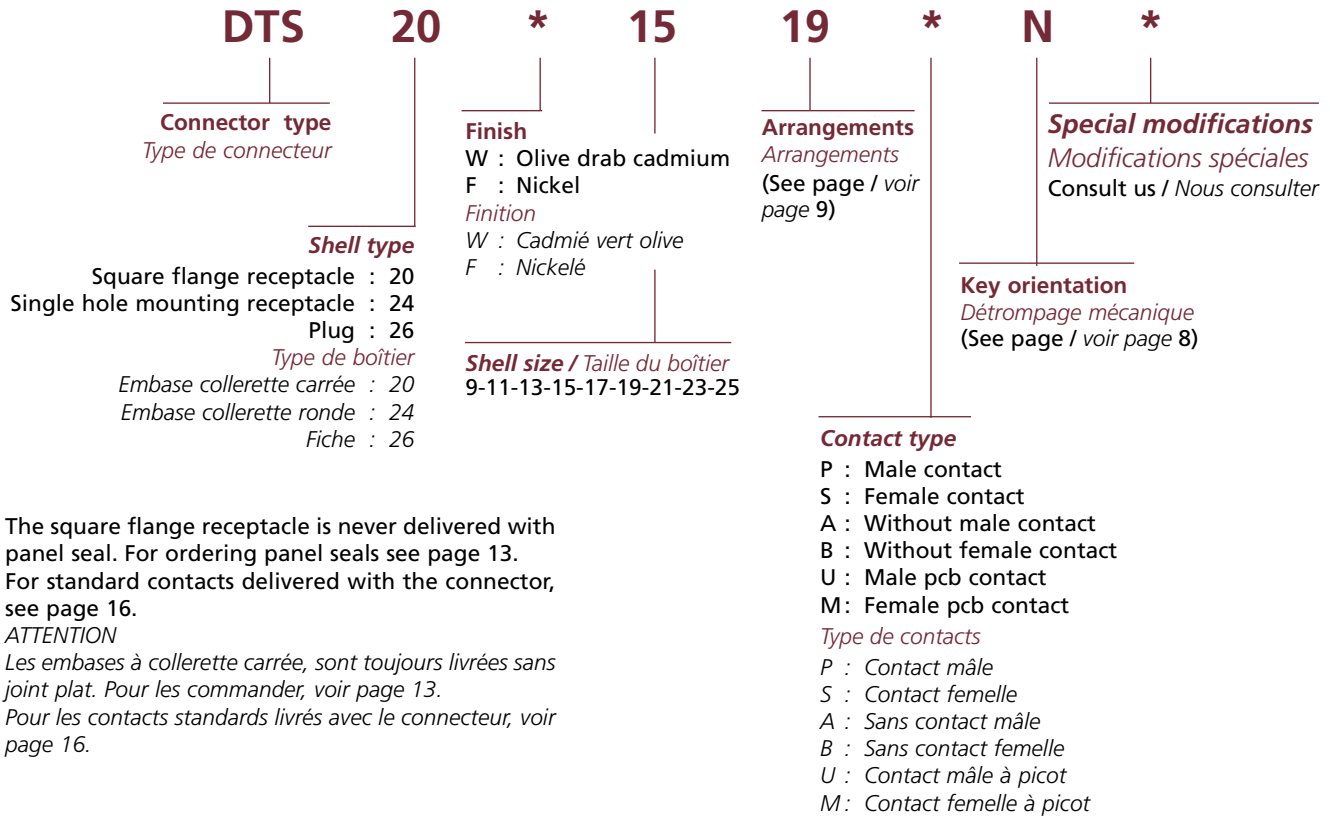

MIL-C 38999 SYSTEM - SEALED VERSION
SYSTEME SUIVANT MIL-C 38999 - VERSION ETANCHE

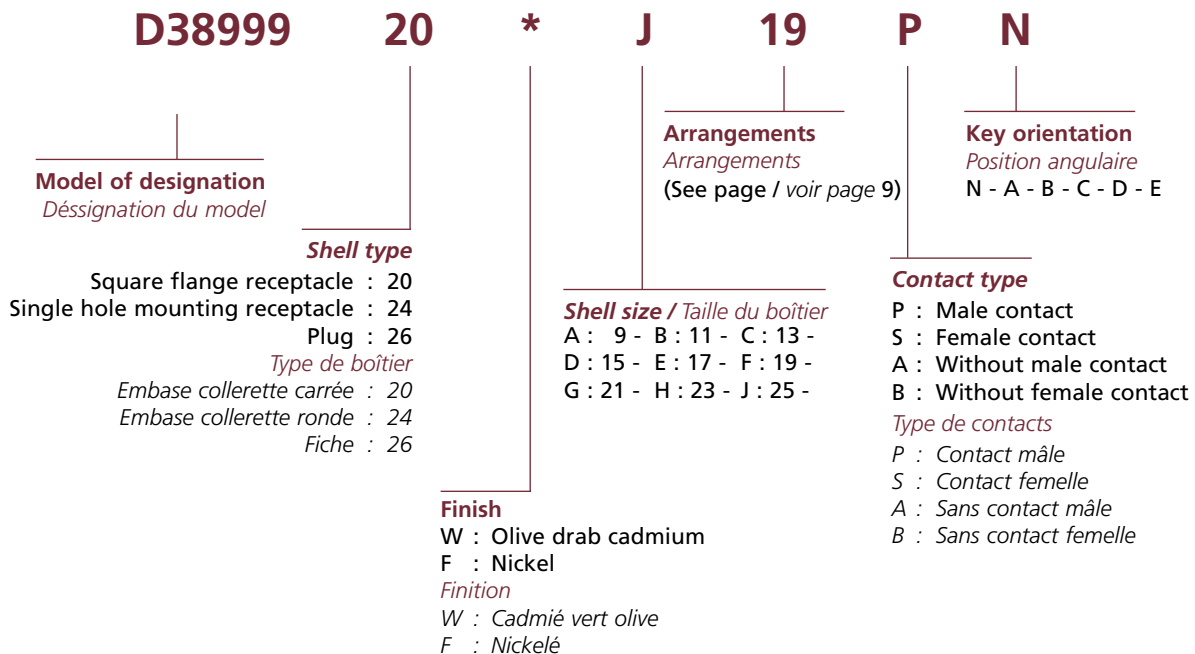

DEUTSCH SYSTEM - HERMETIC VERSION
SYSTEME DEUTSCH - VERSION HERMETIQUE

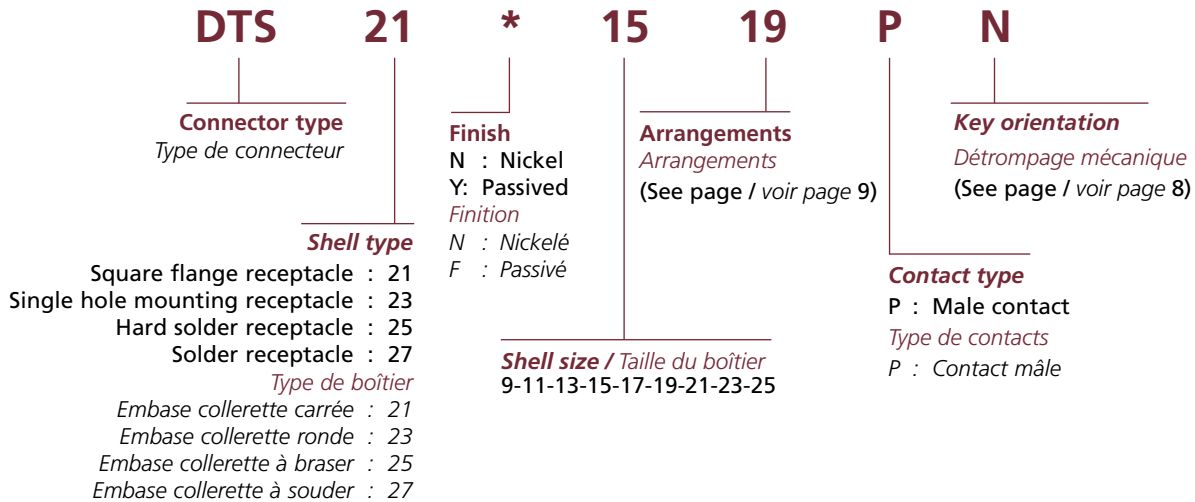

ATTENTION

The square flange receptacle is never delivered with panel seal. For ordering panel seals see page 13. Les embases à collerette carrée, sont toujours livrées sans joint plat. Pour les commander, voir page 13.

MIL-C 38999 SYSTEM - HERMETIC VERSION
SYSTEME SUIVANT MIL-C 38999 - VERSION HERMÉTIQUE

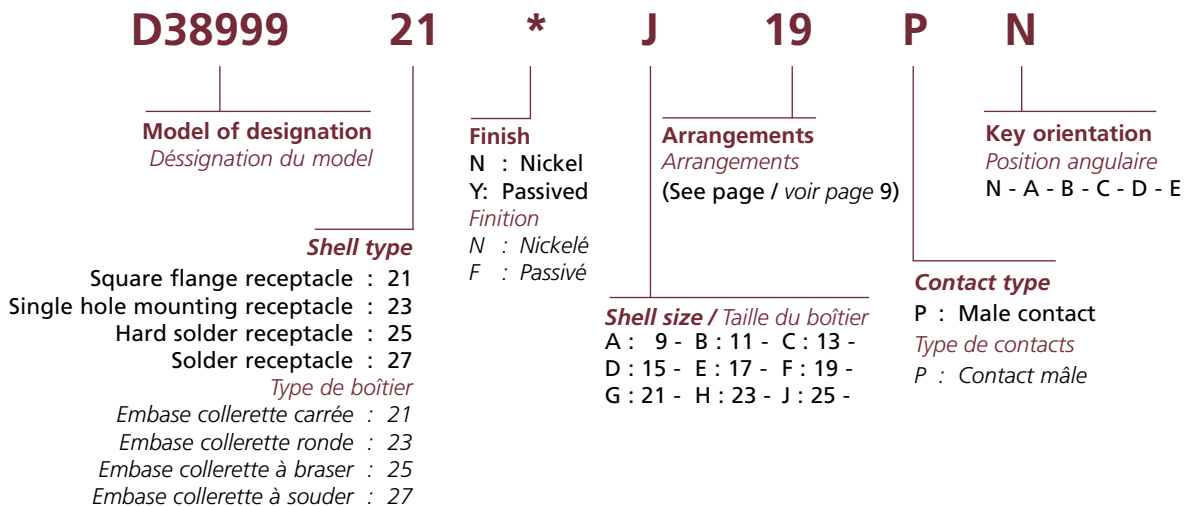



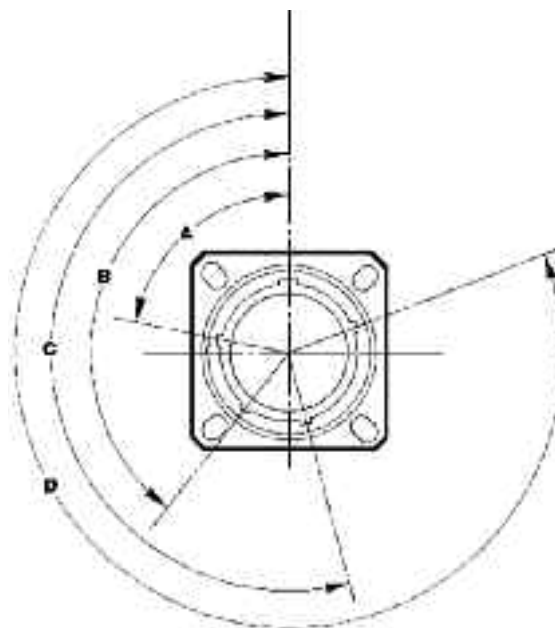



























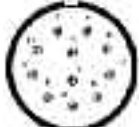





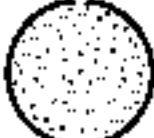

Key orientation
Position angulaire des clés de détrompage

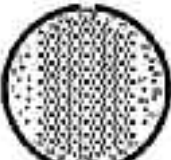
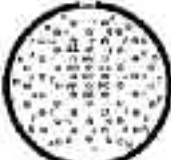

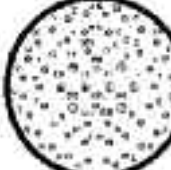
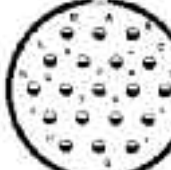
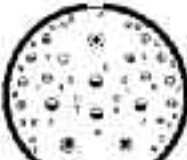
Size Taille	Orientation Position angulaire	Polarization in degrees Polarisation en degrés			
		A	B	C	D
9	N	105	140	215	265
	A	102	132	248	320
	B	80	118	230	312
	C	35	140	205	275
	D	64	155	234	304
11 to/à 15	E	91	131	197	240
	N	95	141	208	236
	A	113	156	182	292
	B	90	145	195	252
	C	53	156	220	255
17 to/à 25	D	119	146	176	298
	E	51	141	184	242
	N	80	142	196	293
	A	135	170	200	310
	B	49	169	200	244
17 to/à 25	C	66	140	200	257
	D	62	145	180	280
	E	79	153	197	272

Male insert viewed from front face / Vu face avant isolant mâle

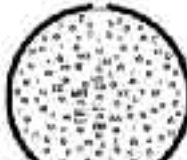
 Disposition 09-35 6 contacts size/taille 22	 Disposition 09-98 3 contacts size/taille 20	 Disposition 11-01 * 1 contacts size/taille 8	 Disposition 11-05 5 contacts size/taille 20	 Disposition 11-12 * 1 contacts size/taille 12	 Disposition 11-35 13 contacts size/taille 22	 Disposition 11-98 6 contacts size/taille 20
 Disposition 11-99 7 contacts size/taille 20	 Disposition 13-04 4 contacts size/taille 16	 Disposition 13-08 8 contacts size/taille 20	 Disposition 13-35 22 contacts size/taille 22	 Disposition 13-98 10 contacts size/taille 20	 Disposition 15-05 5 contacts size/taille 16	 Disposition 15-18 18 contacts size/taille 20
 Disposition 15-19 19 contacts size/taille 20	 Disposition 15-35 37 contacts size/taille 22	 Disposition 15-97 * 8 contacts size/taille 20 4 contacts size/taille 16	 Disposition 17-06 6 contacts size/taille 12	 Disposition 17-08 * 8 contacts size/taille 16	 Disposition 17-26 26 contacts size/taille 20	
 Disposition 17-28 * 2 contacts size/taille 8	 Disposition 17-35 55 contacts size/taille 22	 Disposition 17-99 * 21 contacts size/taille 20 2 contacts size/taille 16	 Disposition 19-11 * 11 contacts size/taille 16	 Disposition 19-32 32 contacts size/taille 20	 Disposition 19-35 66 contacts size/taille 22	
 Disposition 21-11 * 11 contacts size/taille 12	 Disposition 21-16 16 contacts size/taille 16	 Disposition 21-30 * 26 contacts size/taille 22 2 contacts size/taille 12 2 contacts size/taille 8	 Disposition 21-35 79 contacts size/taille 22	 Disposition 21-39 2 contacts size/taille 16 37 contacts size/taille 20	 Disposition 21-41 41 contacts size/taille 20	 Disposition 21-75 * 4 contacts size/taille 8
 Disposition 23-21 * 21 contacts size/taille 16	 Disposition 23-35 * 100 contacts size/taille 22	 Disposition 23-53 53 contacts size/taille 20	 Disposition 23-55 * 55 contacts size/taille 20	 Disposition 25-04 * 48 contacts size/taille 20 8 contacts size/taille 16	 Disposition 25-19 * 19 contacts size/taille 12	
 Disposition 25-20 * 10 contacts size/taille 20 13 contacts size/taille 16 4 contacts size/taille 12 3 contacts size/taille 8	 Disposition 25-24 * 12 contacts size/taille 16 12 contacts size/taille 12	 Disposition 25-29 * 29 contacts size/taille 16	 Disposition 25-35 * 128 contacts size/taille 22	 Disposition 25-46 * 40 contacts size/taille 20 4 contacts size/taille 16 2 contacts size/taille 8	 Disposition 25-61 * 61 contacts size/taille 20	

* Hermetic, consult us. *Hermétiques, nous consulter.*

■ Square flange / Colerette carrée - TYPE 20

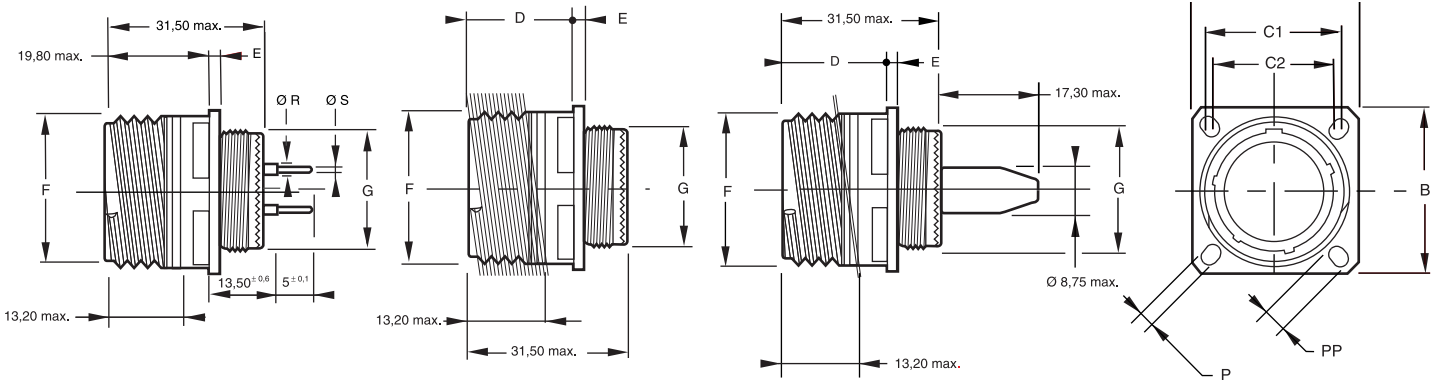

With PCB contacts
Avec contacts à picots

With protect sleeves, see pages 16 and 17
Manchon avec "tétine", voir pages 16 et 17

Contact	R	S
Contact	+ 0 - 0,05	± 0,05
# 22	1	0,5
# 20	1,5	0,7
# 16	2,6	1,15

Size	B	C1	C2	D	E	F	G	P	PP	Mass/Masse
Taille	± 0,3			max.		± 0,1	± 0,1	± 0,2	± 0,2	Alu *
09	23,80	18,26	15,09	20,90	2,50	15,75	11,90	3,25	5,49	10,00
11	26,20	20,62	18,26	20,90	2,50	18,90	14,90	3,25	4,93	16,00
13	28,60	23,01	20,62	20,90	2,50	22,10	17,90	3,25	4,93	22,00
15	31,00	24,61	23,01	20,90	2,50	25,25	21,90	3,25	4,93	31,00
17	33,30	26,97	24,61	20,90	2,50	29,95	24,90	3,25	4,93	46,00
19	36,50	29,36	26,97	20,90	2,50	31,55	27,90	3,25	4,93	51,00
21	39,70	31,75	29,36	20,10	3,20	34,70	30,90	3,25	4,93	65,00
23	42,90	34,93	31,75	20,10	3,20	37,90	33,90	3,91	6,15	78,00
25	46,00	38,10	34,93	20,10	3,20	41,10	36,90	3,91	6,15	97,00

* Mass without contact
Poids sans contact

P/N PCB contacts
Référence contacts à picot
page 17

■ Single hole mounting / Colerette ronde - TYPE 24

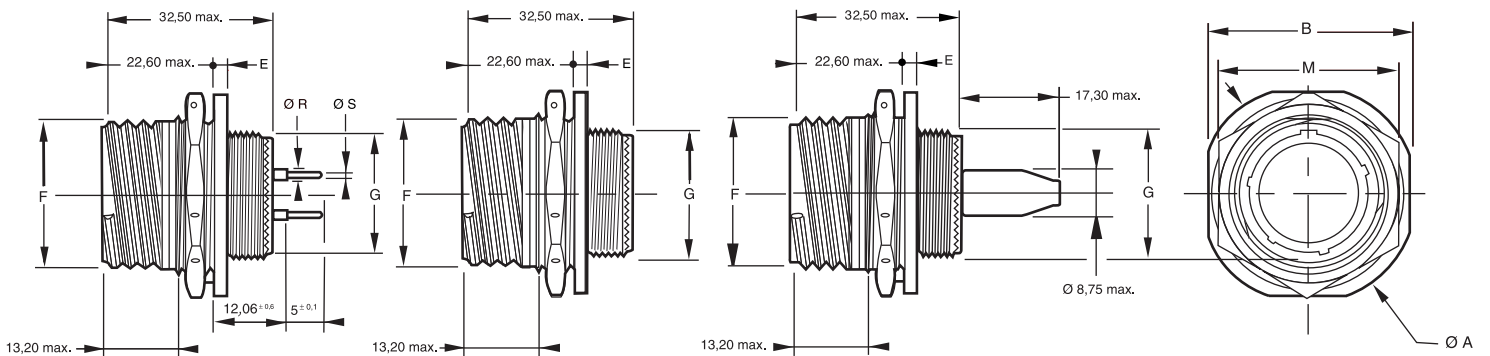

With PCB contacts
Avec contacts à picots

With protect sleeves, see pages 16 and 17
Manchon avec "tétine", voir pages 16 et 17

Contact	R	S
Contact	+ 0 - 0,05	± 0,05
# 22	1	0,5
# 20	1,5	0,7
# 16	2,6	1,15

Size	A	B	E	F	G	M	Mass/Masse
Taille	± 0,3	± 0,4	+ 0,7 - 0,1	± 0,1	± 0,1		Alu *
09	30,20	27,00	2,20	15,75	11,90	21,82	16,00
11	34,90	31,80	2,20	18,90	14,90	24,99	23,00
13	38,10	34,90	2,20	22,10	17,90	29,77	31,00
15	41,30	38,10	2,20	25,25	21,90	32,91	48,00
17	44,50	41,30	2,20	29,95	24,90	36,12	55,00
19	49,20	46,00	3,00	31,55	27,90	39,25	67,00
21	52,40	49,20	3,00	34,70	30,90	42,47	81,00
23	55,60	52,40	3,00	37,90	33,90	45,61	93,00
25	58,70	55,60	3,00	41,10	36,90	49,25	111,00

* Poids sans contact
Mass without contact

P/N PCB contacts
Référence contacts à picot
page 17

■ **Square flange / Collette carrée - TYPE 21**

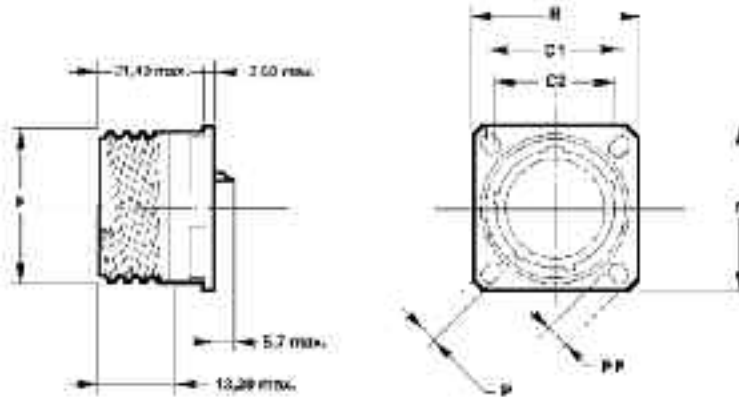

size Taille	B ± 0,3	C1	C2	F ± 0,1	P ± 0,2	PP ± 0,2	Mass/Masse max.
09	23,80	18,26	15,09	15,75	3,25	5,49	25,00
11	26,20	20,62	18,26	18,90	3,25	4,93	35,00
13	28,60	23,01	20,62	22,10	3,25	4,93	45,00
15	31,00	24,61	23,01	25,25	3,25	4,39	59,00
17	33,30	26,97	24,61	29,95	3,25	4,93	83,00
19	36,50	29,36	26,97	31,55	3,25	4,93	89,00
21	39,70	31,75	29,36	34,70	3,25	4,93	110,00
23	42,90	34,93	31,75	37,90	3,91	6,15	127,00
25	46,00	38,10	34,93	41,10	3,91	6,15	148,00

■ **Collette ronde / Single hole mounting - TYPE 23**

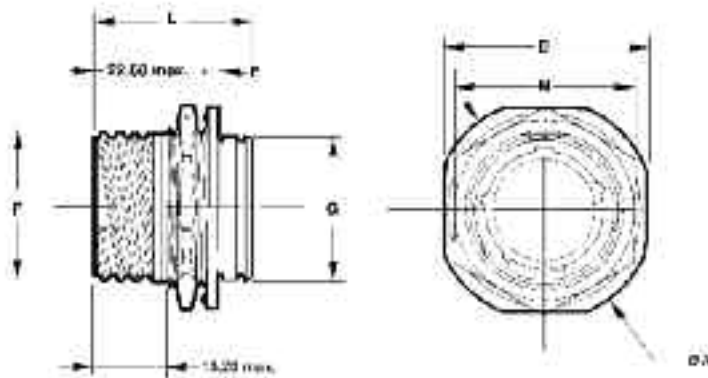

Size Taille	A ± 0,3	B ± 0,4	E + 0,3 - 0,1	F ± 0,1	G + 0,3 - 0,1	L max.	M	Mass/Masse Alu
09	30,20	27,00	2,60	15,75	16,30	29,20	21,82	38,00
11	34,90	31,80	2,60	18,90	19,40	29,20	24,99	49,00
13	38,10	34,90	2,60	22,10	22,70	29,30	29,77	67,00
15	41,30	38,10	2,60	25,25	25,90	29,30	32,91	76,00
17	44,50	41,30	2,60	29,95	29,00	29,30	36,12	108,00
19	49,20	46,00	3,40	31,55	32,20	30,10	39,25	128,00
21	52,40	49,20	3,40	34,70	35,40	30,10	42,47	148,00
23	55,60	52,40	3,40	37,90	38,60	30,10	45,61	154,00
25	58,70	55,60	3,40	41,10	41,70	30,10	49,25	190,00

Hard solder receptacle / Colletette à braser - TYPE 25

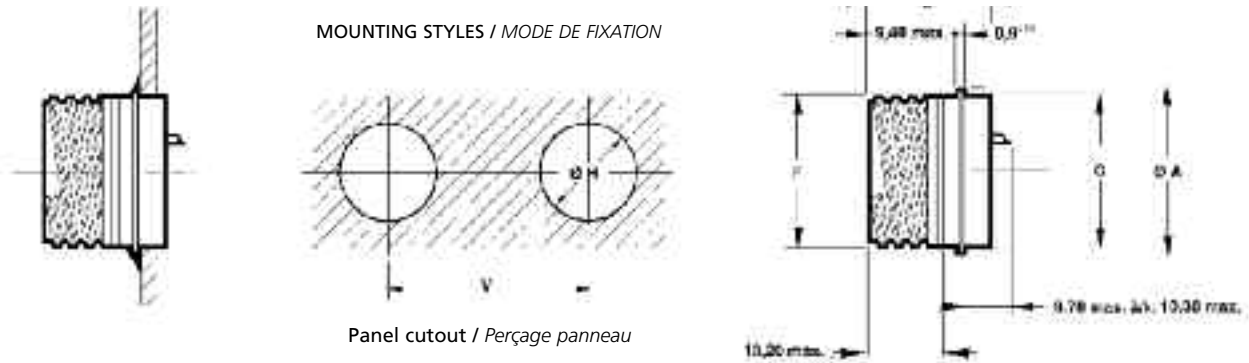

Soldered box mounting / Colletette à souder - TYPE 27

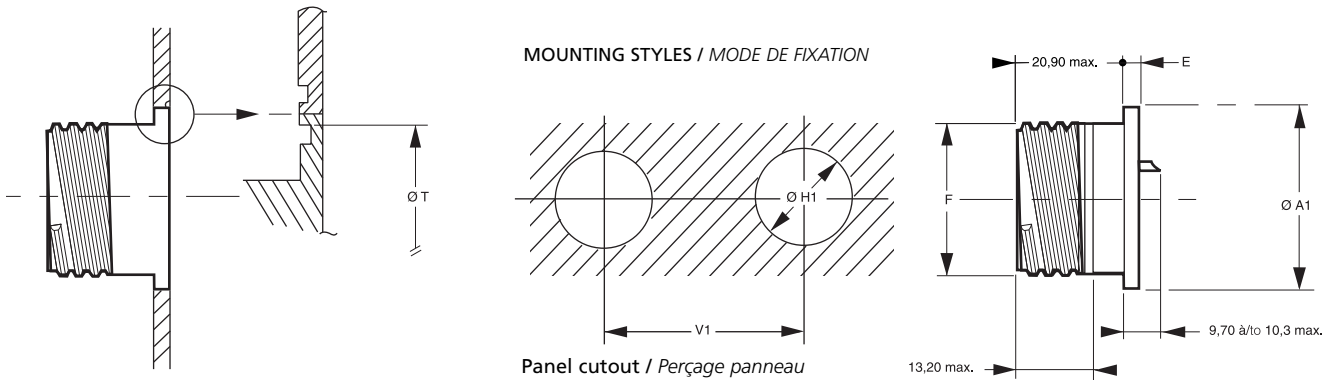

size	A	A1	E	F	G	H	H1	L	V	V1	ØT	Mass/Masse
Taille	max.	+ 0,3 - 0	± 0,2	± 0,1	max.	+ 0, - 0,25	mini.	max.	mini.	+ 0, - 0,25	+ 0, - 0,3	max.
09	19,40	24,70	3,20	15,75	17,10	17,58	25,06	23,80	22,60	27,00	23,90	25,00
11	21,80	27,80	3,20	18,90	19,90	20,35	28,16	23,80	25,80	29,50	27,00	35,00
13	25,10	31,00	3,20	22,10	23,10	23,52	31,36	23,80	30,20	32,50	30,20	45,00
15	28,10	34,20	3,20	25,25	26,20	26,70	34,56	23,80	33,30	35,60	33,40	59,00
17	31,30	36,40	3,20	29,95	29,40	29,87	36,76	23,80	36,50	37,80	35,60	83,00
19	33,60	40,10	3,20	31,55	31,80	32,26	40,46	23,80	39,30	41,50	39,30	89,00
21	36,80	43,70	3,20	34,70	35,00	35,43	44,06	23,80	42,50	45,10	42,90	110,00
23	40,00	47,90	4,00	37,90	38,20	38,60	48,26	24,60	45,70	49,30	47,10	127,00
25	43,20	50,10	4,00	41,10	41,30	41,80	50,46	24,60	48,80	51,50	49,30	148,00

Fiche / Plug

TYPE 26

Taille	F	G	S	Masse/Masse
Size	max.	max.	max.	Alu *
09	18,40	11,90	21,80	15,00
11	21,10	14,90	25,00	20,00
13	25,40	17,90	29,40	31,00
15	28,70	21,90	32,50	42,00
17	32,20	24,90	35,70	55,00
19	34,90	27,90	38,50	63,00
21	38,10	30,90	41,70	79,00
23	41,10	33,90	44,90	88,00
25	44,30	36,90	48,00	109,00

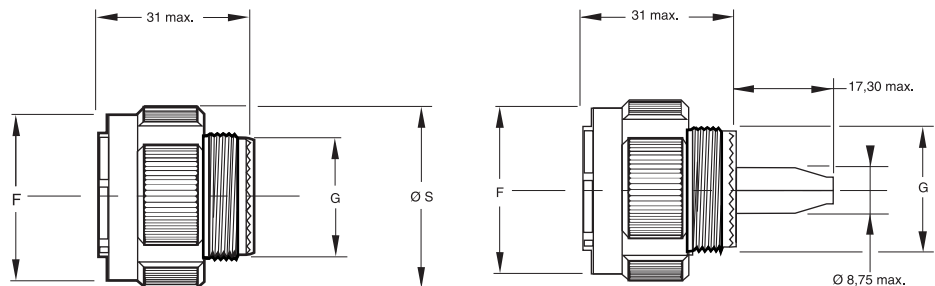

* Poids sans contact / Mass without contact

With protect sleeves, see pages 16 and 17
Manchon avec "tétine", voir pages 16 et 17

■ **TYPE PR**

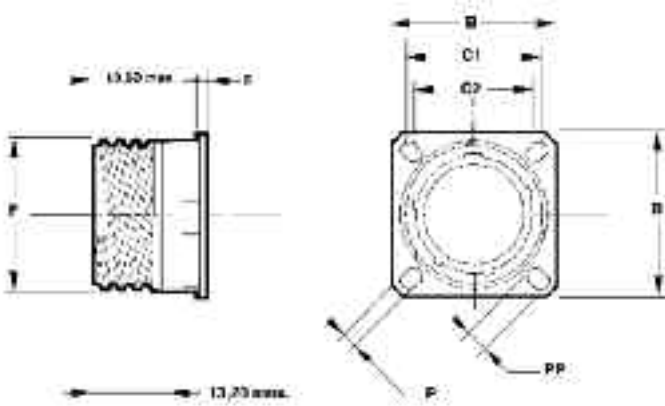

Size Taille	B ± 0,3	C1	C2	E max.	F ± 0,1	P ± 0,2	PP	Mass/Masse max.
09	23,80	18,26	15,09	2,50	15,73	3,25	5,49	10,00
11	26,20	20,62	18,26	2,50	18,91	3,25	4,93	16,00
13	28,60	23,01	20,62	2,50	22,08	3,25	4,93	22,00
15	31,00	24,61	23,01	2,50	25,26	3,25	4,93	31,00
17	33,30	26,97	24,61	2,50	29,96	3,25	4,93	46,00
19	36,50	29,36	26,97	2,50	31,54	3,25	4,93	51,00
21	39,70	31,75	29,36	3,20	34,72	3,25	4,93	65,00
23	42,90	34,93	31,75	3,20	37,90	3,91	6,15	78,00
25	46,00	38,10	34,93	3,20	41,07	3,91	6,15	97,00

Panel seal / *Joint plat*

■ **For square flange receptacle / Pour embase collerette carrée**

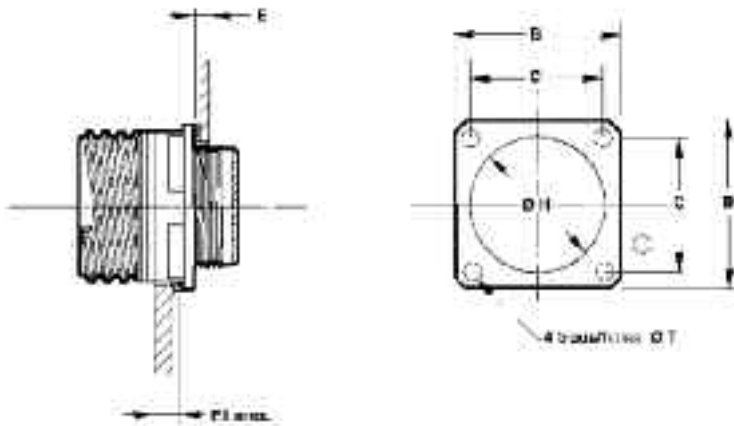

Sealed version
Version Etanche

The panel seal is never delivered with receptacle. To be ordered separately.
Nota : Les joints plats ne sont jamais livrés avec les embases, les commander séparément.

Front flange mounting <i>Joint avant collerette</i>			Rear flange mounting <i>Joint arrière collerette</i>							
Size Taille	Part number Référence	H max.	B max.	C ± 0,10	E max.	E1 max.	T max.	H max.	Part number Référence	Size Taille
09	108-0003-10	15,40	24,30	18,30	3,00	5,92	3,30	14,10	108-0004-10	09
11	108-0001-12	18,40	26,70	20,60	3,00	5,92	3,30	17,20	108-0004-12	11
13	108-0001-14	22,70	29,10	23,00	3,00	5,92	3,30	20,40	108-0004-14	13
15	108-0001-16	25,90	31,30	24,60	3,00	5,92	3,30	23,60	108-0004-16	15
17	108-0003-18	29,10	33,70	27,00	3,00	5,92	3,30	26,80	108-0004-18	17
19	108-0003-20	32,30	36,90	29,40	3,00	5,92	3,30	30,60	108-0001-20	19
21	108-0003-22	35,40	40,10	31,75	3,00	5,16	3,30	33,50	108-0001-22	21
23	108-0003-24	38,60	43,30	34,90	3,00	5,16	4,30	36,30	108-0004-24	23
25	108-0001-25	41,10	46,00	38,10	3,00	4,87	3,90	37,70	108-0012-25	25

Color code / Code couleur

For contact P as per / Pour contact P suivant MIL C 38999

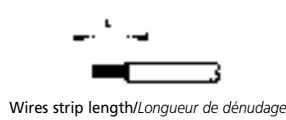
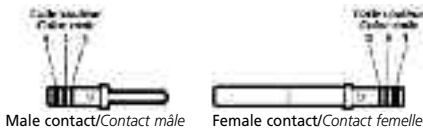

Sealing plug / Obturateur

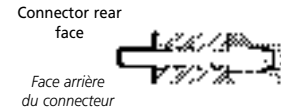

CONTACTS/CONTACTS							CABLES/CABLES			OBTURATEURS SEALING PLUG		
Commerciale Part number Référence Commerciale	Type Genre	Size Taille	Color code Code couleur			Observations Observations	Section Section in/en mm ²	AWG wire gauge	Ø over sheath Ø sur gaine	L	Part number Référence	Color code Code couleur
			1	2	3							
724-0001-22 724-0007-22	P S	22	Orange Orange	Blue Bleu	Black Noir	Standard contact	0,10 to/à 0,38	22 - 28	0,76 to/à 1,37	5,00 à/to 5,80	028-0102-22	Yellow Jaune
			Orange Orange	Yellow Jaune	Grey Gris							
724-0001-20 724-0007-20	P S	20	Orange Orange	Blue Bleu	Orange Orange	Standard contact	0,21 to/à 0,60	20 - 24	1,02 to/à 2,11	5,80 à/to 6,60	006-0893-20	Red Rouge
			Orange Orange	Green Vert	Brown Marron							
724-0001-16 724-0007-16	P S	16	Orange Orange	Blue Bleu	Yellow Jaune	Standard contact	0,60 to/à 1,34	16 - 20	1,65 to/à 2,77	5,80 à/to 6,60	006-0893-16	Blue Bleu
			Orange Orange	Green Vert	Rouge Red							
724-0001-12 724-0007-12	P S	12	Orange Orange	Blue Bleu	Vert Green	Standard contact	1,93 to/à 3,18	12 - 14	2,46 to/à 3,61	5,80 à/to 6,60	006-0892-12	Yellow Jaune
			Orange Orange	Green Vert	Orange Orange							
182-0001-08 182-0003-08	P S	8	-	-	-	Power contact Contact de puissance	5,30 to/à 8,98	8	4,50 to/à 5,80	9,20 à/to 9,80	182-0064-08	-
182-0068-20 182-0009-20	P S	20	Yellow Jaune	Purple Violet	Vert Vert	Alumel contact	0,21 to/à 0,60	20 - 24	1,02 to/à 2,11	5,80 à/to 6,60	006-0893-20	Red Rouge
			Yellow Jaune	Grey Gris	Purple Violet							
182-0069-20 182-0010-20	P S	20	Yellow Jaune	Purple Violet	Bleu Bleu	Chromel contact	0,21 to/à 0,60	20 - 24	1,02 to/à 2,11	5,80 à/to 6,60	006-0893-20	Red Rouge
			Yellow Jaune	Grey Gris	Grey Gris							
182-0068-22 182-0279-22	P S	22	Yellow Jaune	Purple Violet	Brown Marron	Alumel contact	0,10 to/à 0,38	22 - 28	0,76 to/à 1,37	5,00 à/to 5,80	028-0102-22	Yellow Jaune
			Yellow Jaune	White Blanc	Green Vert							
182-0069-22 182-0280-22	P S	22	Yellow Jaune	Purple Violet	Rouge Red	Chromel contact	0,10 to/à 0,38	22 - 28	0,76 to/à 1,37	5,00 à/to 5,80	028-0102-22	Yellow Jaune
			Yellow Jaune	White Blanc	Blue Bleu							

DATABUS CONTACTS # 8 (TWISTED PAIR) AS PER MIL-C 38999 SERIES I, III AND IV STANDARD CONTACT DATABUS # 8 (PAIRE BLINDEE) CONFORME A LA NORME MIL-C 38999 SERIES I, III et IV

CONTACTS/CONTACTS				CABLES/CABLES			MANCHON/SLEEVE	OUTILLAGE/TOOLS		
Part number Référence	Type Genre	Size Taille	Color code Code couleur	Types Types	Conduct. max. section Section max. conduct.	Braid Ø max. tresse	Type Type	Pince à sertir Crimping tool		Outil Tool
								Conductor conducteur	Ferrule Ferrule	Extraction Extraction
182-0034-03 182-0035-03	P S	8	Brown-red Marron-rouge	Braid simple Simple tresse	0,86 mm ²	3,48	Thermosetting and silicone Silicone et thermodurcissable	TDB-CT-08	TDB-CT-HEX Empreinte C Mark C	114-008 or/ou M 81969/14-06
182-0034-04 182-0035-04	P S	8	Red-red Rouge-rouge	Hight immunity double braid Double tresse haute immunité	0,86 mm ²	3,91	Thermosetting and silicone Silicone et thermodurcissable	TDB-CT-08	TDB-CT-HEX Empreinte D Mark D	114-008 or/ou M 81969/14-06

Nota : Size 8 and Bus contacts are delivered with protect sleeve.

Les contacts taille 8 et Bus, sont livrés avec le manchon de protection arrière "Tétine".

Standards contacts delivered with connector.
Contacts standards livrés avec le connecteur



TOOLS/OUTILLAGE				CONTACTS STANDARDISATION NORMES DE REFERENCE DES CONTACTS	
Outil/Tool Insertion d'insertion		Extraction d'extraction	Crimping tool Pince à sertir	Pilot stop for crimping tool Butée pour pince à sertir	MIL-C
M 81969/14-01			M 22520/2-01	M 22520/2-09 M 22520/2-07	MIL-C 39029/58-360 MIL-C 39029/56-348
M 15570-20			M 22520/1-01	M 22520/1-04	MIL-C 39029/58-363 MIL-C 39029/56-351
M 15570-16			M 22520/1-01	M 22520/1-04	MIL-C 39029/58-364 MIL-C 39029/56-352
M 15570-12			M 22520/1-01	M 22520/1-04	MIL-C 39029/58-365 MIL-C 39029/56-353
Manual Manuel	M 81969/14-06		M 22520/5-01	SP 593	-
M 15570-20			M 22520/1-01	M 22520/1-04	MIL-C 39029/87-475 MIL-C 39029/88-487
M 15570-20			M 22520/1-01	M 22520/1-04	MIL-C 39029/87-476 MIL-C 39029/88-488
M 81969/14-01			M 22520/2-01	M 22520/2-09 M 22520/2-07	MIL-C 39029/87-471 MIL-C 39029/89-495
M 81969/14-01			M 22520/2-01	M 22520/2-09 M 22520/2-07	MIL-C 39029/87-472 MIL-C 39029/89-496

PCB CONTACTS CONTACTS A PICOTS		
Type Genre	Size Taille	Part number Référence
P	22	724-0902-22
	20	724-0902-20
	16	724-0902-16
	12	724-0902-12
S	22	724-0904-22
	20	724-0904-20
	16	724-0904-16
	12	724-0904-12

COAXIAL CONTACTS CONTACTS COAXIAUX			
Size Taille	Type Genre	MIL C 39029	Part number Référence
16	P	76	724-0004-16
	S	77	182-0013-16
12	P	102	182-0100-12
	S	103	182-0101-12
8	P	59	182-0127-68
	S	60	182-0128-68

CONTACTS BLINDES SHIELDED CONTACTS			
Size Taille	Type Genre	MIL C 39029	Part number Référence
12	P	28	182-0098-12
	S	52	182-0099-12



CONNECTEURS ELECTRIQUES DEUTSCH

17, rue Lavoisier z.i. n° 2 B.P. 117 27091 EVREUX CEDEX 09 (FRANCE) - Tél.: +33 (0)2 32 23 57 00 - Fax : +33 (0)2 32 23 58 00
E-mail : ced@deutsch.net - Web : www.deutsch.net - Réf.: CC 750-41 G Edition Mars 2008