

## 阅读申明

- 1.本站收集的数据手册和产品资料都来自互联网，版权归原作者所有。如读者和版权方有任何异议请及时告之，我们将妥善解决。
- 2.本站提供的中文数据手册是英文数据手册的中文翻译，其目的是协助用户阅读，该译文无法自动跟随原稿更新，同时也可能存在翻译上的不当。建议读者以英文原稿为参考以便获得更精准的信息。
- 3.本站提供的产品资料，来自厂商的技术支持或者使用者的心得体会等，其内容可能存在描述上的差异，建议读者做出适当判断。
- 4.如需与我们联系，请发邮件到marketing@iczoom.com，主题请标有“数据手册”字样。

## Read Statement

1. The datasheets and other product information on the site are all from network reference or other public materials, and the copyright belongs to the original author and original published source. If readers and copyright owners have any objections, please contact us and we will deal with it in a timely manner.
2. The Chinese datasheets provided on the website is a Chinese translation of the English datasheets. Its purpose is for reader's learning exchange only and do not involve commercial purposes. The translation cannot be automatically updated with the original manuscript, and there may also be improper translations. Readers are advised to use the English manuscript as a reference for more accurate information.
3. All product information provided on the website refer to solutions from manufacturers' technical support or users the contents may have differences in description, and readers are advised to take the original article as the standard.
4. If you have any questions, please contact us at marketing@iczoom.com and mark the subject with "Datasheets" .



## Specifications for BNC Connectors

BNC style connectors are miniature, light-weight, weatherproof interconnecting devices characterized by their two-stud, quick disconnect bayonet lock coupling arrangement. Their design functions satisfactorily from DC to 11 GHz in static applications, or from DC to 4GHz in applications involving vibration. The connectors typically yield a low VSWR (reflected signal) to 4GHz. Primary applications include radio telecommunications, broadcast equipment, medical equipment, computer, Precision Video, High definition studio broadcast, video switching and test instrumentation where frequent coupling and de-coupling are necessary. Bomar's BNCs are available in an extensive variety of configurations and cable sizes and are impedance matched to either 50 ohm or 75 ohm.

MATERIALS		
Connector Parts	Material	Equivalent Standard
Connector Body and Parts	Brass	ISOCuZn38Pb2 Body Part
Male Contact Pin	Brass	QQ-B-626
Commercial Grade	Zinc Alloy/Brass	-----
Outer Contact	Brass	QQ-B-750
Socket Contact	Beryllium Copper	QQ-C-530 / MIL-H-7199
-----	Phosphor Copper	CuBe2
Crimp Ferrule	Annealed Copper	QQ-C-576
Insulators, Standard Versions	Teflon	L-P403 / BS4271
-----	Delrin	Grade B
Rubber Gaskets	Silicone Rubber	ASTM-E1418PSI
Plating	Nickel (Silver Optional)	MIL-G-45204

ELECTRICAL			
Requirement	Performance		Test † Specification
Impedance	50Ω	75Ω	
Frequency Range	0-4GHz	0-1 GHz	-----
VSWR	1.30 Max.		MIL-C-39012
RF Insertion Loss	0.2 db Min. at 3 GHz		MIL-C-39012
RF Leakage	-55 db Min. at 3 GHz		MIL-C-39012
Test Voltage ( At Sea Level)	1500V rms		MIL-STD-202
Working Voltage ( At Sea Level )	500V rms		MIL-STD-202
Insulation Resistance	5000 Meg ohms Min.		MIL-STD-202
Contact Resistance	3 Milli ohms Max.		MIL-C-39012

MECHANICAL & ENVIRONMENTAL		
Requirement	Performance	Test † Specification
Durability	500 Insertions & Extractions Min.	MIL-C-39012
Shock	50 G	MIL-STD-202
Vibration	20 G from 80-2000 Hz	MIL-STD-202
Cable Retention (Cable Types)	60 lbs. Minimum Pull Test	MIL-C-39012
Coupling Nut	60 lbs. Maximum	MIL-C-39012
Temperature Range	Teflon: -55 to +199 C	-----
	Delrin: -40 to +85 C	-----
Moisture Resistance	Continuous Test	MIL-STD-202
Salt Spray	48 Hours	MIL-STD-202

†Products are made to conform to the Mil standard but are for commercial applications and are not QPL

FOR TECHNICAL SUPPORT: PHONE 973-347-4040 / FAX973-347-2111 <a href="#">Back to Index</a>	<b>1</b>
---	----------

-Page1-

-Page2-



## BNC 3 Piece Crimp

BNC three piece crimp connectors feature semi-captive contacts that "click" into place assuring perfect installation. Each crimp pin has a vent hole for optional soldering. Soldering is recommended for all stranded conductors 26 AWG or smaller.

Part Number (Male)	Gender	(I.D.) **	Fig. No.	RG/U Cable
310A205A	✓	.200 In.	Fig. 1	6, 21 AWG Center Conductor
310A205A18	✓	.200 In.	Fig. 1	6 CATV, 18 AWG Center Conductor
310A205F	✓	.124 In.	Fig. 1	58A/U, 58C/U Stranded, 141, Thin PVC
310A205FS	✓	.124 In.	Fig. 1	58/U Solid Conductor
310A205FV	✓	.125 In.	Fig. 2	58/U Thin-Net Plenum
310A205FV2	✓	.125 In.	Fig. 2	Mini 59, RGB Cable (23 AWG)
310A205FV3	✓	.125 In.	Fig. 2	Mini 59, RGB Cable (26 AWG)
310A204G	✓	.150 In.	Fig. 1	59, 62, 210
310A205G20	✓	.150 In.	Fig. 1	RG59 20 AWG Center Cond.
310A205G23	✓	.150 In.	Fig. 1	Belden 8241
310A205MV	✓	.125 In.	Fig. 3	174, 178, 196, Mini RGB Cable 50 Ω
310B205MV	✓	.125 In.	Fig. 3	174, 178, 196, Mini RGB Cable 75 Ω
310A205N	✓	.090 In.	Fig. 3	179, 187
310A205P	✓	.125 In.	Fig. 1	223
310B205Q	✓	.205 In.	Fig. 1	Belden 8281 True 75 Ohms
310A204T	✓	.150 In.	Fig. 2	59, 62, Plenum
310A208W2	✓	.103 In.	Fig.1	Mini 59, RGB Cable (26 AWG)
✓ RoHS compliant ** crimp shank <a href="#">REQUEST QUOTE</a> <a href="#">REQUEST DRAWING</a>				

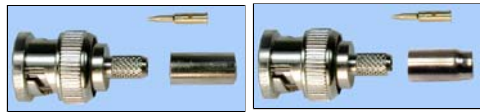

Fig.1

Fig.2



Fig.3

[Click Here for Connector Dimensions/Stripping Dimensions](#)

## BNC Twist-On and 2 Piece Crimp

BNC Twist-On connectors are field installable and require no tooling other than a stripping tool for the cable preparation. The center conductor is inserted into Bomar's unique Posi-Con™ contact, as the connector is twisted onto the cable's outer jacket.

BNC 2 Piece crimp connectors make use of a fully captivated pin. Just insert the center conductor into the connector body, slide the ferrule over the braid, and apply a single hex-crimp to the ferrule. These connectors are easy to install and reliable and are recommended only for the lower data transmission speeds.

Part Number	Gender	Fig. No.	RG/U Cable
310A405A	✓ Male	Fig. 8	6, Thick net
310A405F	✓ Male	Fig. 8	58A/U Solid Cond, 141, Thin PVC
310A405F1	✓ Male	Fig. 8	58/U Solid Cond. -.172" - .178"
310A405F2	✓ Male	Fig. 8	58/U Thin Plenum -.158" - .162"
310A405F3	✓ Male	Fig. 8	Thin Plenum .150"
310A405G	✓ Male	Fig. 8	59, 62, 210 PVC
310A405T	✓ Male	Fig. 8	59, 62, 210 Plenum
320A405F	✓ Female	Fig. 8A	58 Solid (PVC)
320A405G	✓ Female	Fig. 8A	59, 62, 210 (PVC)
310X205F	✓ Male	Fig. 6	RG58 (PVC)
310X205G	✓ Male	Fig. 6	RG59, 62 (PVC)
320X205F	✓ Female	Fig. 7	RG58 (PVC)
320X205G	✓ Female	Fig. 7	RG59, 62 (PVC)
✓ RoHS compliant <a href="#">REQUEST QUOTE</a> <a href="#">REQUEST DRAWING</a>			



Fig.8A



Fig.8



Fig.6



Fig.7

FOR TECHNICAL SUPPORT: PHONE 973-347-4040 / FAX 973-347-2111 [Back to Index](#)

2

-Page 2-

- Page 3 -



## BNC Connectors

### BNC Standard Clamp

BNC standard clamp style is a simplified version of the original military clamp style. It is required that the contact be soldered to the center conductor

of the cable.









Part Number		Gender	Fig. No.	RG/U Cable
310A105A		Male	9	6
310A105D		Male	9	11A
310A105F		Male	9	58, 58A, 58C, 141
310A105G		Male	9	59, 62, 210
310A105M		Male	9	174, 188, 316
320A105F*		Female	N/S	58, 58A, 58C, 141
320A105G*		Female	N/S	59, 62, 214



Figure 9











 RoHS compliant [REQUEST QUOTE](#) [REQUEST DRAWING](#)

## BNC Specialty Broadcast Plugs

[Click here for complete Broadcast Catalog](#)

Broadcast grade BNC connectors are perfectly matched to 75 ohm impedance's. The superior plugs are for studio wiring and other broadcast uses. Solid precision machined brass, not die-cast, hold up under the toughest conditions. Here, we are showing the eight most popular but there are many more versions matched to the popular cable manufacturer's part number.



Part Number		Gender	Belden Cable
SBC1505A		Male	1505A
SBC1694A		Male	1694A
SBC1695A		Male	1695A
SBC1855A		Male	1855A
SBC7731A		Male	7731A
SBC8218		Male	8218
SBC8241		Male	8241
SBC8281		Male	8281

 RoHS compliant [REQUEST QUOTE](#) [REQUEST DRAWING](#)

## BNC Bulkhead Jacks

Versions are available for front mounting, (F/M) rear mounting, (R/M) crimp types, bulkhead mount grounded, or bulkhead mount, isolated. (Color-coded available.) These jacks are held into the panel by a hex-nut and lock washer. All units feature nickel plated, brass bodies, and gold phosphor-bronze contacts



Figure 13



























Figure 14



Figure 15



Figure 16

Part Number		Description	Fig No.	Hole ID	Dwg
321A245A		R/M Crimp, RG6	13	.500	
321A245F		R/M Crimp, RG58, Thin-net PVC	13	.500	
321A245FV		R/M Crimp, Thin-Net Plenum	13	.500	
321A245G		R/M Crimp, RG59, 62, 210	13	.500	
321A245M		R/M Crimp, RG174, 188, 196, 316	13	.500	
321B245M*		R/M Crimp, RG174, 188, 196, 316	13	.500	
321B245N*		R/M Crimp, RG179, 187	N/S	.500	
326A515		F/M Solder (Grounded)	14	.375	
326R515		F/M Solder (Isolated) White Bushing	15	.375	
326R515RD		F/M Solder (Isolated) Red Bushing	16	.375	
326R515GN		F/M Solder (Isolated) Green Bushing	16	.375	
326R515BL		F/M Solder (Isolated) Blue Bushing	16	.375	

[REQUEST QUOTE](#) [REQUEST DRAWING](#)

 RoHS compliant



## BNC Panel Jacks and Plugs

BNC panel plugs and jacks are of machined brass construction for maximum reliability and quality. All contacts are plated with a minimum of five micro-inches of gold. The square panel types mount on .500 inch centers. The bulkhead type mounts into a .380 "D" shaped panel hole. All connector bodies are bright-nickel plated.

Part Number		Description	Notations	Fig. No.	Dwg.
316A524C		Male Bulkhead Panel Mount	.380" Mtg. Hole	19	
317A507		Male Panel Mount	.500 Mtg. Hole Centers	20	
321A205F		Female Panel Mount, Crimp	Fits RG58/U Cables	21	---
321A205G		Female Panel Mount, Crimp	Fits RG59, 62, 210	21	---
321A205M		Female Panel Mount, Crimp	Fits RG174, 178, 196	21	---
327A507		Female Panel Mount, Solder	.500 Mtg. Hole Centers	22	---

RoHS compliant    [REQUEST QUOTE](#)    [REQUEST DRAWING](#)

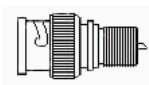

Figure 19

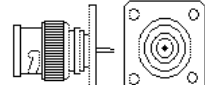

Figure 20

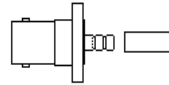

Figure 21



Figure 22

## BNC PC Board Vertical Jacks

BNC vertical mount jacks are available in straight PC mounts and "through-panel" styles. The "through-panel", 364 Series, is made in both isolated and grounded versions and are ideal for applications where multiple insertions will require a connector which can endure the stress of higher torque.

Part Number		Body Plating or Material	Description	Insul. Mat.	Con. Plating	"L" Dim	Fig. No.	Dwg.
361A514*		Nickel / Brass	Straight PC Mount 50Ω	Teflon	Gold	.717	26	---
361A505*		Nickel / Brass	Straight PC Mount 50 Ω	Delrin	Gold	.914	27	---
361A534*		Nickel / Brass	3 Post PC Mount 50 Ω	Delrin	Gold	.788	27A	
361A505APF		Nickel/Zinc	4 Post W/ Press Fit Center Pin 50Ω	Delrin	Gold	.925	27B	
361A705APF		Nickel/Zinc	4 Post W/ Press Fit Center Pin 75Ω	Delrin	Gold	.925	27B	
364S595		White Valox	PC Mount, Thru-Panel, 50 Ω	Delrin	Gold	1.36	23	
364S595B		Black Valox	PC Mount, Thru-Panel, 50 Ω	Delrin	Gold	1.36	24	
364S595M		Nickel/Zinc	PC Mount, Thru-Panel, 50 Ω	Delrin	Gold	1.36	25	
364S795*		White Valox	PC Mount, Thru-Panel, 75 Ω	Delrin	Gold	1.36	23	
364S795B*		Black Valox	PC Mount, Thru-Panel, 75 Ω	Delrin	Gold	1.36	24	
364S795M*		Nickel/Zinc	PC Mount, Thru-Panel, 75 Ω	Delrin	Gold	1.3	25	

RoHS compliant reflow or wave solder    RoHS compliant wave solder only    [REQUEST QUOTE](#)    [REQUEST DRAWING](#)

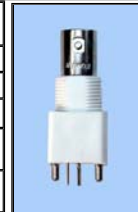

Fig. 23

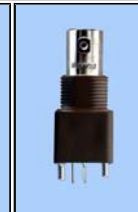

Fig. 24

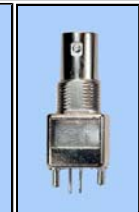

Fig. 25

S

S

S

S

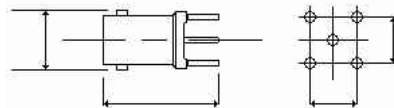

Fig. 26



The press-fit center pin locks the connector into the PC board so it is held firmly for reflow or wave soldering.

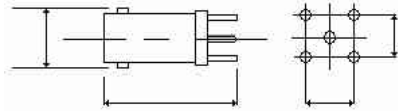

Fig. 27B

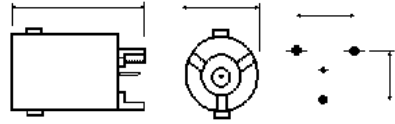

Fig. 27A

\* Denotes that items are not popular and may require a special minimum quantity requirement.

FOR TECHNICAL SUPPORT: PHONE 973-347-4040 / FAX 973-347-2111 [Back to Index](#)



## BNC Connectors

### BNC PC Board Right Angle JacksX

These BNC jacks are manufactured to the highest standards to assure stability in maintaining impedance matching at 50 ohm and 75 ohm applications. The 50 ohm versions have been approved by most of the U.S. manufacturers of LAN cards, and the 75 ohm is in wide use in High Definition Video applications which require the use of a True 75 ohm connector. Contacts are phosphor bronze and will remain resilient even after hundreds of insertions.

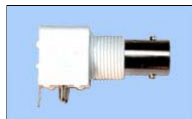

Fig. 28 ig.



Fig. 29



Fig. 30



Fig. 31



Fig. 32



Fig. 33



Fig. 34



Fig. 35

Part Number		Body Material	Description	Imp.	Height F.M.S.	Contact Plating	Fig. No.	Dwg.
364M095	✓	Nickel/Zinc	4 Post Low Profile, Metal	50Ω	.453	Gold	38	
364M0975	✓	Nickel/Zinc	4 Post Low Profile, Metal	75Ω	.453	Gold	38	
364A595	✓	White Valox	Standard Profile W/ Posts	50Ω	.610	Gold	28	
364A595T	✓	White Valox	Standard Profile W/ Posts (TPX)	50Ω	.610	Gold	28	
364A595NP*	✓	White Valox	Standard Profile WO Posts	50Ω	.610	Gold	35	
364A595NPT*	✓	White Valox	Standard Profile WO Posts (TPX)	50Ω	.610	Gold	35	
364A595B	✓	Black Valox	Standard Profile W/ Posts	50Ω	.610	Gold	30	
364A595BT	✓	Black Valox	Standard Profile W/ Posts (TPX)	50Ω	.610	Gold	30	
364A595BNP*	✓	Black Valox	Standard Profile WO Posts	50Ω	.610	Gold	35	
364A595BNPT*	✓	Black Valox	Standard Profile WO Posts (TPX)	50Ω	.610	Gold	35	
364A595BL	✓	White Valox	Lo Profile W/ Posts	50Ω	.515	Gold	29	
364A595BLT	✓	White Valox	Lo Profile W/ Posts (TPX)	50Ω	.515	Gold	29	
364A595BLNP*	✓	White Valox	Lo-Profile W/O Posts	50Ω	.515	Gold	34	
364A595BLB	✓	Black Valox	Lo-Profile W/ Posts	50Ω	.515	Gold	31	
364A595BLBT	✓	Black Valox	Lo-Profile W/ Posts (TPX)	50Ω	.515	Gold	31	
364A595BLBNP*	✓	Black Valox	Lo-Profile W/O Posts	50Ω	.515	Gold	34	
364M595	✓	Nickel/Zinc	Standard Profile W/ Posts	50Ω	.620	Gold	32	
364M595T	✓	Nickel/Zinc	Standard Profile W/ Posts (TPX)	50Ω	.620	Gold	32	
364M595M	✓	Nickel/Zinc	Super Lo-Profile W/ Clips	50Ω	.340	Gold	35A	
364M595MT	✓	Nickel/Zinc	Super Lo-Profile W/ Clips (TPX)	50Ω	.340	Gold	35A	
364M595L	✓	Nickel/Zinc	Lo-Profile W/ Posts	50Ω	.529	Gold	33	
364M595LT	✓	Nickel/Zinc	Lo-Profile W/ Posts (TPX)	50Ω	.529	Gold	33	
364A795	✓	White Valox	Standard Profile W/ Posts (TPX)	75Ω	.610	Gold	28	
364A795T	✓	White Valox	Standard Profile W/ Posts	75Ω	.610	Gold	28	
364A795B	✓	Black Valox	Standard Profile W/ Posts	75Ω	.610	Gold	30	





Fig. 36 (top) Fig. 37

364A795BT	✓	Black Valox	Standard Profile W/ Posts (TPX)	75Ω	.610	Gold	30	✗
364A795BL	✓	White Valox	Lo-Profile W/ Posts	75Ω	.515	Gold	29	✗
364A795BLT	✓	White Valox	Lo-Profile W/ Posts (TPX)	75Ω	.515	Gold	29	✗
364A795BLB	✓	Black Valox	Lo-Profile W/ Posts	75Ω	.515	Gold	31	✗
364A795BLBT	✓	Black Valox	Lo-Profile W/ Posts (TPX)	75Ω	.515	Gold	31	✗
364M795	✓	Metal	Standard Profile W/ Posts	75Ω	.620	Gold	32	✗
364M795T	✓	Metal	Standard Profile W/ Posts (TPX)	75Ω	.620	Gold	32	✗
364M795L	✓	Metal	Lo-Profile W/ Posts	75Ω	.529	Gold	33	✗
364M795LT	✓	Metal	Lo-Profile W/ Posts (TPX)	75Ω	.529	Gold	33	✗
364F595BL	✓	White Valox	9400pF 500V Decoupled	50Ω	.515	Gold	36	---
364F595BLB	✓	Black Valox	9400 pF 500V Decoupled	50Ω	.515	Gold	37	---
364H595BL	✓	White Valox	9400 pF 1500V Decoupled	50Ω	.515	Gold	36	---
364H595BLB	✓	Black Valox	9400 pF 1500V Decoupled	50Ω	.515	Gold	37	---
364NT	✓	Zinc/Brass	Jam Nut ( 364 Series)	N/A	----	----	36N	✗
364LW	✓	Zinc/ Steel	Lock Washer ( 364Series)	N/A	----	----	37N	✗
364KNT	✓	Brass/Nickel	Knurled Nut (364 Series)	N/A	----	----	38N	✗

RoHS compliant reflow or wave solder   
  RoHS compliant wave solder  
 only    [REQUEST QUOTE](#)    [REQUEST DRAWING](#)

(TPX) insulator for re-flow solder

**Board Clips Are Available In Place  
of Posts. Add Suffix "C"**



Spear-point clips lock snugly into the board.

## Hardware

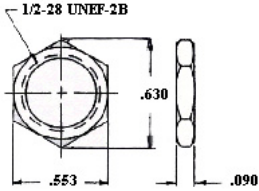
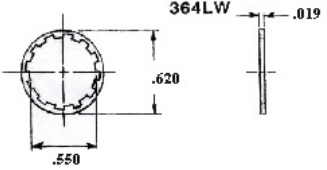
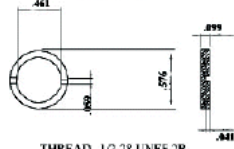
<p><b>Note:</b> Mounting hardware is optional and must be ordered separately. Hardware is not sold without the connectors.</p>	Fig. 36N	Fig. 37N
	<p><b>364NT</b></p> 	<p><b>364LW</b></p> 
	Fig. 38N	
	<p><b>364KNT</b></p> 	

\* Denotes that items are not popular and may require a special minimum order quantity.    [REQUEST QUOTE](#)    [REQUEST DRAWING](#)



## BNC V-Bite® PC Edge Mount

The **V-Bite®** is an industry award winning design PCB connector with all the advantages a designer could want. It edge mounts to the board which offers the lowest profile and utilizes very little PCB real estate. It lends itself to surface mount and through-hole soldering techniques. There are versions for IR and convection reflow soldering. Because the connector locks into place both above and below the PCB it disperses rotational torque relief to the board and not the solder points. The **V-Bite®** design offers the lowest VSWR ratings due to the straight through-put contact design. No right angles for reflection. Available in 50 and 75 ohm, threaded and non-threaded. Other options for PCB thickness available. Other interfaces available.  
( See "F", BNC Twin and TNC sections.)

Part Number	RoHS	Description	Imp	Contact	Fig. No.	Dwg.
361V504ER	✓	BNC Jack W/ Teflon For Reflow Solder	50Ω	Brass./Gold	39A	
361V504ET	✓	BNC Threaded Jack W/ Teflon For Reflow Solder	50Ω	Brass./Gold	39	
361V504EFT	✓	BNC Threaded Jack W/ Teflon Insulator/Flange	50Ω	Brass./Gold	39B	
361V509E	✓	BNC Jack W/ Polyethylene Insulator	50Ω	Brass./Tin	39A	
361V509ET	✓	BNC Threaded Jack W/ Polyethylene Insulator	50Ω	Brass./Tin	39	---
361V704ER	✓	BNC Jack W/ Teflon For Reflow Solder	75Ω	Brass./Gold	39A	
361V704ET	✓	BNC Threaded Jack W/ Teflon For Reflow Solder	75Ω	Brass./Gold	39	
361V704EFT	✓	BNC Threaded Jack W/ Teflon Insulator/Flange	75Ω	Brass./Gold	39B	
361V709E	✓	BNC Jack W/ Polyethylene Insulator	75Ω	Brass./Gold	39A	---
361V709ET	✓	BNC Threaded Jack W/ Polyethylene Insulator	75Ω	Brass./Gold	39	---
361KNT	✓	Knurled Nut (361 Series)	NA	---	---	
3M61V704	✓	Mini- BNC Jack W/ Teflon for Reflow Solder	75Ω	Brass./Gold	39C	

RoHS compliant reflow or wave solder   
  RoHS compliant wave solder only   
 [REQUEST QUOTE](#)   
 [REQUEST DRAWING](#)



**Low Profile .270 High FMS**  
 Anti Rotational  
**VSWR 1.15:1**  
**Patented V-Bite® Snaps Into PCB**  
**Surface Mount Center Contact**  
**Pick & Place Version Available**

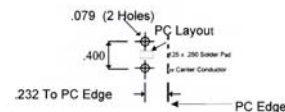

Fig. 39

Fig.39A

Fig.39B

Fig. 39C



S

S

## BNC Reduced Size PCB Right Angle Mount

**The Super Low™** Profile BNC PC jack reduces the amount of board space needed to mount a PC jack. Board clips hold the unit in place for soldering. The smallest, lowest profile right angle BNC jack available.

**The Lo-Deco™** features a four post design that offers greater stability after wave soldering. Also featured is a gold plated contact and nickel plated cast zinc body. Smooth, sleek and aesthetically pleasing design is tumbled to remove casting lines.

Part Number	RoHS	Description	Imp.	Contact	Fig. No.	Dwg.
364M595M	✓	BNC Super Low Profile Jack	50Ω	Phos./Gold	35A	
364M595MT	✓	BNC Super Low Profile Jack	50Ω	Phos./Gold	35A	
364M795M	✓	BNC Super Low Profile Jack	75Ω	Phos./Gold	35A	
364M795MT	✓	BNC Super Low Profile Jack	75Ω	Phos./Gold	35A	





364M095	✓	BNC Lo-Deco Jack	50Ω	Phos./Gold	38	
364M0975	✓	BNC Lo-Deco Jack	75Ω	Phos./Gold	38	
<input checked="" type="checkbox"/> RoHS compliant reflow or wave solder		<input checked="" type="checkbox"/> RoHS compliant wave solder only				<a href="#">REQUEST</a>
		<a href="#">QUOTE</a>		<a href="#">REQUEST DRAWING</a>		

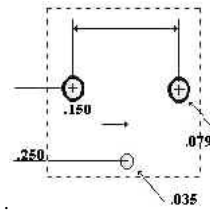

Fig 35A

PC Layout for Super Low Profile



Fig. 38

\*Denotes that items are not popular and may require a special minimum order quantity.

FOR TECHNICAL SUPPORT: PHONE 973-347-4040 / FAX 973-347-2111 [Back to Index](#)

6

- Page 6 -

- Page 7 -



## BNC Connectors

### BNC Dual PC Jacks (Threaded)

**Right Angle or Vertical Stacked:** When board space becomes a serious issue and you still need the robust, full size, BNC connectors, a dual stacked right angle or vertical version will do the trick. Assembly insertion time is cut in half as well. The Dual 364 series is available in both Valox isolated and all metal construction.

(shown with closed back option FS)



Fig. 38A

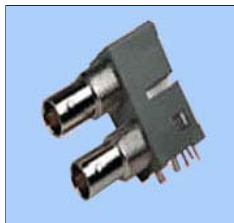

Fig. 38B



Fig. 40D



Fig. 38C

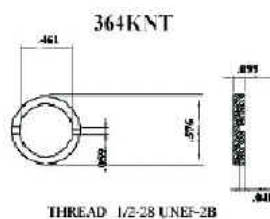

Right Angle						
Part Number		Description	Imp.	Contact	Fig.No.	Dwg.
364A2595	✓	Dual Right Angle, White Valox	50Ω	Phos./Gold	38A	
364A2595T	<input checked="" type="checkbox"/>	Dual Right Angle, White Valox (TPX)	50Ω	Phos./Gold	38A	
364A2795	✓	Dual Right Angle, White Valox	75Ω	Phos./Gold	38A	
364A2795T	<input checked="" type="checkbox"/>	Dual Right Angle, White Valox (TPX)	75Ω	Phos./Gold	38A	
364A2595B	✓	Dual Right Angle, Black Valox	50Ω	Phos./Gold	38A	
364A2795B	✓	Dual Right Angle, Black Valox	75Ω	Phos./Gold	38A	
364M2595	✓	Dual Right Angle, Metal	50Ω	Phos./Gold	38B	
364M2595T	<input checked="" type="checkbox"/>	Dual Right Angle, Metal (TPX)	50Ω	Phos./Gold	38B	
364M2795	✓	Dual Right Angle, Metal	75Ω	Phos./Gold	38B	
364M2795T	<input checked="" type="checkbox"/>	Dual Right Angle, Metal (TPX)	75Ω	Phos./Gold	38B	
3M64M2795	✓	Dual Right Angle, Metal Mini-BNC	75Ω	Phos./Gold	38C	
364KNT	<input checked="" type="checkbox"/>	Knurled Nut for Dual BNC	N/A	Brass/Nickel	38D	
Vertical						
Part Number		Description	Imp.	Contact	Fig.No.	Dwg.
364S2595	✓	Dual Vertical, White Valox	50Ω	Phos./Gold	40D	
364S2795	✓	Dual Vertical, White Valox	75Ω	Phos./Gold	40D	
364S2595B	✓	Dual Vertical, Black Valox	50Ω	Phos./Gold	40D	
364S2795B	✓	Dual Vertical, Black Valox	75Ω	Phos./Gold	40D	
364S2595M	✓	Dual Vertical, Metal	50Ω	Phos./Gold	----	
364S2795M	✓	Dual Vertical, Metal	75Ω	Phos./Gold	----	
Tool						

Fig. 38D

Fig. 38E

Part Number	Description	Imp.	Contact	Fig.No.
BD36400	- Hex Shafted Tool for Knurled Nut	N/A	Steel/Nickel	38E

RoHS compliant reflow or wave solder      RoHS compliant wave solder only  
[QUOTE](#)     [REQUEST DRAWING](#)     [REQUEST](#)

Note: Hardware is optional and must be ordered separately

## BNC Multi-Port PC Jacks (Non-Threaded)

**Side By Side:** These right angle units are available in dual or quad configurations. These units are not threaded for panel installation using a jam nut. Up one fourth the installation time.

Part Number	Description	Imp.	Contact	Fig. No.
365A2595	Dual Right Angle, Side By Side White Valox	50Ω	Phos./Gold	38B
365A2795	Dual Right Angle, Side By Side White Valox	75Ω	Phos./Gold	38B
365A2595B	Dual Right Angle, Side By Side Black Valox	50Ω	Phos./Gold	38B
365A2795B	Dual Right Angle, Side By Side Black Valox	75Ω	Phos./Gold	38B
365A4595	Quad Right Angle, Side By Side White Valox	50Ω	Phos./Gold	NS
365A4795	Quad Right Angle, Side By Side White Valox	75Ω	Phos./Gold	NS
365A4595B	Quad Right Angle, Side By Side Black Valox	50Ω	Phos./Gold	NS
365A4795B	Quad Right Angle, Side By Side Black Valox	75Ω	Phos./Gold	NS

RoHS compliant reflow or wave solder      RoHS compliant wave solder only  
[QUOTE](#)     [REQUEST DRAWING](#)     [REQUEST](#)

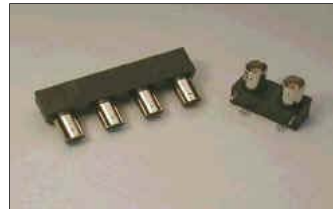

Fig.38B

FOR TECHNICAL SUPPORT: PHONE 973-347-4040 / FAX 973-347-2111

[Back to Index](#)

7

- Page 7 -

- Page 8 -

- Page 9 -



## BNC Adapters

These sturdy within-series BNC adapters are available in all standard designs. Additionally, several unique constructions compliment the product group and allow adaptations for every conceivable application. All connector bodies are plated with bright nickel. Male contacts are brass, female contacts are phosphor bronze. All contacts are plated with 5 micro inches of gold.

Part Number		Description	Fig. No.
330A505		Male/ Male Inline Barrel Splice	35
332A505		Female/Female Inline Splice	36
335A544		Female/Female Inline Bulkhead Mount (Grounded)	37
335R544		Female/Female Inline Isolated Bulkhead (Metal Outer Thread)	37
343A205F		Crimp "T" Adapter for RG58 Cable	41
343A205G		Crimp "T" Adapter for RG59, 62 Cables	41
343A505		Female/Male/Female "T" Adapter (Yes, it runs with Netware™)	38
345A505		Female/Female/Female "T" Adapter	39
351A505		Female/Male Right Angle Adapter	40
383U505		The Goalie™	42
383U205F		The Goalie Brute™ Crimp Version for RG58 Cable	45
383U205G		The Goalie Brute™ Crimp Version for RG59, 62 Cables	45
383K505*		The Goalie Brute™	43
383P505*		The Insulated Goalie	44
353U205F*		Male/Female/Female Right Angle Double-Down™Crimp for RG58	49
353U205G*		Male/Female/Female Right Angle Double-Down™ Type for RG59	49
353U505*		Male/Female/Female Right Angle Double-Down™	48
393U205F*		Male/Female/Female Straight Double-Down™Crimp for RG58	47
393U205G*		Male/Female/Female Straight Double-Down™Crimp for RG59	47
393U505*		Male/Female/Female Straight Double-Down™	46

RoHS compliant

[REQUEST QUOTE](#)

[REQUEST DRAWING](#)

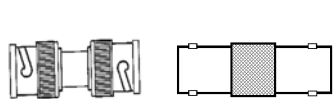
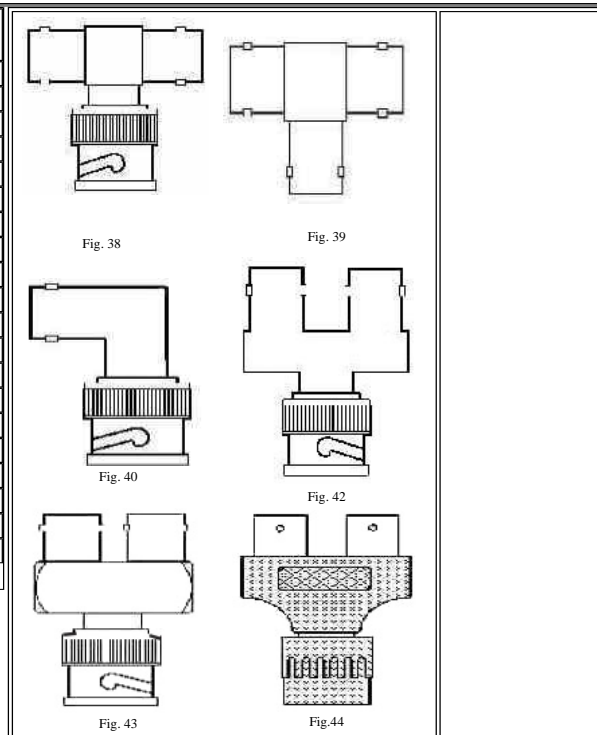

Fig. 35

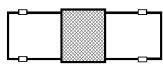

Fig. 36

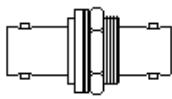

Fig. 37

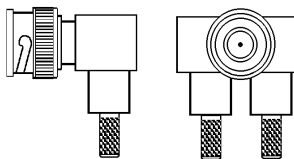

Fig. 48

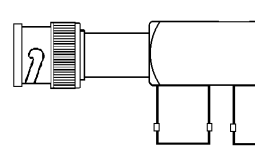

Fig. 46

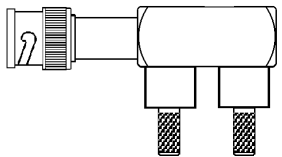

Fig. 41

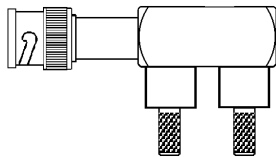

Fig. 49

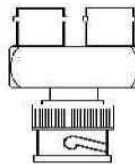

Fig. 45

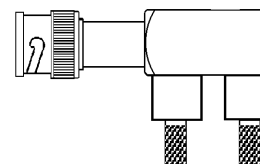
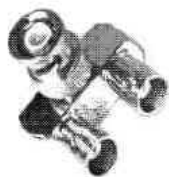

Fig. 47

## Specialty LAN Adapters

Double Down™ adapters are designed to allow parallel cables entering a patch panel, or a BNC LAN terminal port to be guided at a right angle to the input jack. Two versions accomplish this: one is a right angle with side-by-side jacks for areas with little rear clearance, and the other is a straight version for installations where width between panel jacks is limited. Crimp types are for permanent installations. Goalie, and Goalie Brute allow parallel cable 90° entry which require a minimum of rotational cable space.



\*Minimum quantity Requirements May Apply - Contact Sales



## BNC Connectors

### BNC Terminators

BNC terminators are available in standard 1% tolerance versions and in the economy 5% tolerance styles. The standard types have removable color coded caps for easy identification. The economy type are color coded as well but caps are not removable.

Part Number		Description	Fig. No.
310X054A	<input checked="" type="checkbox"/>	50 Ω with Red Cap	50
310C054	<input checked="" type="checkbox"/>	50 Ω with Grounding Chain	51
310X074	<input checked="" type="checkbox"/>	75 Ω with Blue Cap	50
HBC310X075	<input checked="" type="checkbox"/>	75 Ω Precision .1% Tolerance	52
310X094	<input checked="" type="checkbox"/>	93 Ω with Yellow Cap	50
HBC310X075	<input checked="" type="checkbox"/>	75 Ω Precision .1% Tolerance	53
EJ175	<input checked="" type="checkbox"/>	50 Ω Economy	N/S
EJ177	<input checked="" type="checkbox"/>	75 Ω Economy	N/S
EJ179	<input checked="" type="checkbox"/>	93 Ω Economy	N/S

RoHS compliant    [REQUEST QUOTE](#)    [REQUEST DRAWING](#)



Fig. 50



Fig. 51



Fig. 52

S

S

S

SS

FOR TECHNICAL SUPPORT: PHONE 973-347-4040 / FAX 973-347-2111    [Back to Index](#)

10



### Coax Crimp Tools

Professional grade hex-crimp tools for coaxial connectors are available in ratchet and non-ratcheting types, both provide dependable service. Ratchet tools feature replaceable dies. Included is a convenient release mechanism to unlatch the ratchet in the event of an improper crimp. Each tool also crimps the contact pin to the conductor.

Part Number	Description
BD10100	Hex Crimp Ratchet for "F" Types, RG59, RG6
BDHD100	Hex Crimp Ratchet for Belden 8281
BDHD200	Hex Crimp Ratchet for BNC/TNC RG58,59,62 and MV
BDHD100	Hex Crimp Ratchet for Mini-RG59
BD11012	Hex Crimp Ratchet for "N" Crimp RG11, RG213, RG214
BDHD100	Hex Crimp Ratchet for BNC/TNC RG6, RG59

[REQUEST QUOTE](#)

S